

SWITEL

SWISS BRAND 

Strahlungsarmes schnurloses DECT-/GAP-Telefon

Téléphone DECT/GAP sans fil, à faible rayonnement

Telefono cordless DECT/GAP a basse radiazioni

Low-radiation cordless DECT/GAP telephone

DCT 587x Combo



Bedienungsanleitung
Mode d'emploi
Istruzioni per l'uso
Operating Instructions

SWITEL

Bedienungsanleitung 3

Mode d'emploi 53

Istruzioni per l'uso 103

Operating Instructions 153

Declaration of Conformity 204

1	Sicherheitshinweise	4
2	Inbetriebnahme	6
3	Bedienelemente	9
4	Einführende Informationen	12
5	Menüstruktur	14
6	Bedienung	21
7	Anrufbeantworter	33
8	Erweitern des Telefonsystems	40
9	Nebenstellenanlagen / Zusatzdienste	42
10	Technische Eigenschaften	44
11	Probleme	45
12	Pflegehinweise / Garantie	47
13	Stichwortverzeichnis	48

Sicherheitshinweise

1 Sicherheitshinweise

Lesen Sie diese Bedienungsanleitung sorgfältig durch.

Bestimmungsgemäße Verwendung

Dieses Telefon mit Mobilteil ist geeignet zum Telefonieren innerhalb eines Telefonnetzes. Jede andere Verwendung gilt als nicht bestimmungsgemäß. Eigenmächtige Veränderungen oder Umbauten sind nicht zulässig. Öffnen Sie das Gerät in keinem Fall selbst und führen Sie keine eigenen Reparaturversuche durch.

Stromausfall

Bei Stromausfall kann mit diesem Telefon nicht telefoniert werden. Halten Sie für Notfälle ein schnurgebundenes Telefon bereit, welches ohne externe Stromversorgung arbeitet.

Aufstellungsort

Der Aufstellort hat einen entscheidenden Einfluss auf einen einwandfreien Betrieb des Telefons. Vermeiden Sie Belastungen durch Rauch, Staub, Erschütterungen, Chemikalien, Feuchtigkeit, Hitze oder direkte Sonneneinstrahlung. Verwenden Sie das Telefon nicht in explosionsgefährdeten Bereichen.

Stellen Sie das Telefon nicht in die unmittelbare Umgebung von anderen elektronischen Geräten wie z. B. Fernsehgeräten, Mikrowellen, Kühlschränke usw., da es sonst zu gegenseitiger Beeinflussung kommen kann. Stellen Sie das Telefon nicht in die Nähe eines anderen Telefons. Achten Sie darauf, dass sich keine großen metallischen Gegenstände, z. B. ein Kühlschrank oder ein Spiegel, zwischen Basisgerät und Mobilteil befinden. Auch Wände können Einfluss auf die Verbindung zwischen Basisgerät und Mobilteil haben.

Stellen Sie das Telefon in der Nähe einer geeigneten Steckdose und in der Nähe des Telefonanschlusses auf. Achten Sie darauf, dass man über das Kabel nicht stolpern kann!



Achtung: Die Kabel dürfen nicht verlängert werden!

Stellen Sie das Telefon auf eine ebene und rutschfeste Fläche. Normalerweise hinterlassen die Gerätefüße keine Spuren auf der Aufstellfläche. Wegen der Vielzahl der verwendeten Lacke und Oberflächen kann es jedoch nicht ausgeschlossen werden, dass durch die Gerätefüße Spuren auf der Aufstellfläche entstehen.

Je höher das Basisgerät steht (auch innerhalb eines Gebäudes), desto besser ist ihre Reichweite.

Netzteil



Achtung: Verwenden Sie nur das mitgelieferte Netzteil, da andere Netzteile das Telefon beschädigen können. Sie dürfen den Zugang zum Netzteil nicht durch Möbel oder andere Gegenstände versperren.

Aufladbare Akkus



Achtung: Werfen Sie Akkus nicht ins Feuer. Verwenden Sie nur Akkus des gleichen Typs! Achten Sie auf die richtige Polung! Bei verkehrter Polung der Akkus besteht beim Aufladen Explosionsgefahr.



Achtung: Verwenden Sie nur die vorgeschriebenen Akkus. Verwenden Sie keine Batterien. Explosionsgefahr!

Medizinische Geräte



Achtung: Benutzen Sie das Telefon nicht in der Nähe von medizinischen Geräten. Eine Beeinflussung kann nicht völlig ausgeschlossen werden.

Hörgerätekompatibel

Das Telefon ist mit den meisten am Markt befindlichen Hörgeräten kompatibel. Eine einwandfreie Funktion mit jedem Hörgerät kann jedoch nicht garantiert werden.

DECT¹-Telefone können in Hörgeräten einen unangenehmen Brummtönen verursachen.

Entsorgung

Wollen Sie Ihr Gerät entsorgen, bringen Sie es zur Sammelstelle Ihres kommunalen Entsorgungsträgers (z. B. Wertstoffhof). Nach dem Elektro- und Elektronikgerätegesetz sind Besitzer von Altgeräten gesetzlich verpflichtet, alte **Elektro- und Elektronikgeräte** einer getrennten Abfallerfassung zuzuführen. Das nebenstehende Symbol bedeutet, dass Sie das Gerät auf keinen Fall in den Hausmüll werfen dürfen!



Gefährdung von Gesundheit und Umwelt durch Akkus und Batterien!

Akkus und Batterien nie öffnen, beschädigen, verschlucken oder in die Umwelt gelangen lassen. Sie können giftige und umweltschädliche Schwermetalle enthalten. Sie sind gesetzlich verpflichtet, Akkus und Batterien beim batterievertreibenden Handel sowie bei zuständigen Sammelstellen, die entsprechende Behälter bereitstellen, sicher zu entsorgen. Die Entsorgung ist unentgeltlich. Die Symbole bedeuten, dass Sie Akkus und Batterien auf keinen Fall in den Hausmüll werfen dürfen und sie über Sammelstellen der Entsorgung zugeführt werden müssen.



Verpackungsmaterialien entsorgen Sie entsprechend den lokalen Vorschriften.

¹ DECT: Digital Enhanced Cordless Telecommunication = Standard für kabellose Telefone.

Inbetriebnahme

2 Inbetriebnahme

Sicherheitshinweise



Achtung: Lesen Sie vor der Inbetriebnahme unbedingt die Sicherheitshinweise in Kapitel 1.

Verpackungsinhalt prüfen

Zum Lieferumfang gehören:

Inhalt	DCT 587X-Modell			
	DCT 5871	DCT 5872 ¹	DCT 5873 ¹	DCT 5874 ¹
Basisgerät	1	1	1	1
Netzteil	1	1	1	1
Hörer	1	1	1	1
Hörerspiralkabel	1	1	1	1
Telefonanschlusskabel	1	1	1	1
Ladestation mit Netzteil	1	2	3	4
Mobilteil	1	2	3	4
Akkus (AAA 1.2 V NiMH)	2	4	6	8
Bedienungsanleitung	1	1	1	1

¹ Unter www.switel.com erfahren Sie, ob dieses Telefon/Telefonset bereits erhältlich ist.

Gerät in Betrieb nehmen

Basisgerät anschließen

Schließen Sie das Basisgerät wie auf der Skizze abgebildet an. Verwenden Sie aus Sicherheitsgründen nur das mitgelieferte Netzteil.

Beachten Sie unbedingt die Ausführungen zum Aufstellungsort  Seite 4.

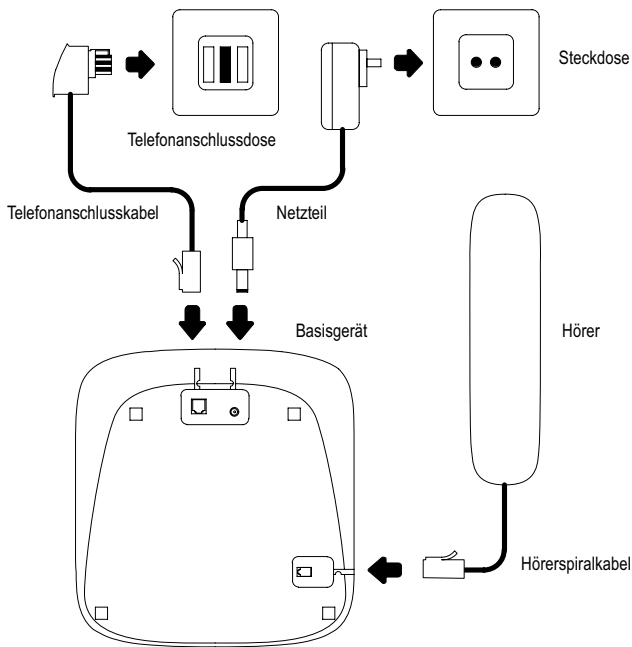

Verwenden Sie für das Basisgerät das Netzteil mit den Ausgangsdaten 100-240 Vac
6 Vdc 500 mA.

Ladestation anschließen

Schließen Sie die Ladestation an eine Steckdose an.

Inbetriebnahme

Akkus in Mobilteil einsetzen

Das Akkufach befindet sich auf der Rückseite Ihres Mobilteils. Öffnen Sie das Akkufach und setzen Sie 2 Akkus vom Typ AAA NiMH, 1.2 V 500 mAh ein. Achten Sie auf die richtige Polung! Schließen Sie das Akkufach.

Akkus aufladen



Stellen Sie das Mobilteil bei der ersten Inbetriebnahme für **mindestens 8 Stunden** in die Ladestation.

Haben Sie das Mobilteil richtig in die Ladestation gestellt, ertönt ein Hinweissignal. Das Mobilteil erwärmt sich beim Laden. Dies ist normal und ungefährlich. Laden Sie das Mobilteil nicht mit fremden Aufladegeräten. Der aktuelle **Akkuladestand** wird im Display angezeigt:



Voll



Leer

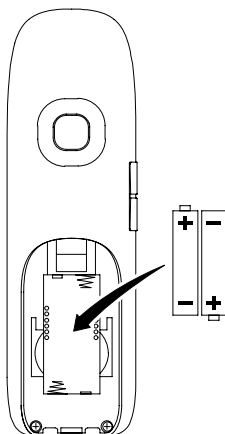

Display-Sprache einstellen

Wählen Sie die entsprechende Sprache aus. Auf den Seiten 18 und 20 finden Sie die Position im Menü.

MT: > MT-Einstell. > Sprache >...

BS: > Basis-Einst. > Sprache >...

Es stehen 9 Sprachen zur Auswahl: Deutsch, Französisch, Italienisch, Englisch, Spanisch, Portugiesisch, Niederländisch, Polnisch und Türkisch.

Datum und Uhrzeit einstellen

Datum und Uhrzeit stellen Sie über das Menü ein (Zeit einst.) Seite 17.

Bestätigen Sie die Eingabe von Jahr, Monat, Tag, Stunde und Minute jeweils mit der Taste bzw. . Beachten Sie das eingestellte Zeit- und Datumsformat Seite 17. Ist das 12 Stunden Format eingestellt, wählen Sie mit den Tasten / aus, ob die eingestellte Zeit vor Mittag (A) oder nach Mittag (P) bedeutet.

Nebenstellenanlagen

Auf Seite 42 erhalten Sie weitere Informationen, falls Sie Ihr Telefon an eine Nebenstellenanlage anschließen möchten.

Strahlungsreduzierung (ECO-Mode)









Die Strahlung wird im Vergleich zu Standard-DECT-Schnurlostelefonen im Bereitschaftsmodus erheblich verringert, wenn das Mobilteil in der Ladestation steht. Im Gesprächsmodus wird die Strahlung abhängig von der Entfernung des Mobilteils zum Telefon (zur Basisstation) verringert.



3 Bedienelemente

Die Tasten werden in dieser Bedienungsanleitung nachfolgend mit vereinheitlichten umrandeten Symbolen dargestellt. Leichte Abweichungen der Tastensymbole Ihres Telefons gegenüber den hier verwendeten Tastensymbolen sind daher möglich.

Basisgerät

- | | | | |
|----|---|----|--|
| 1 | Hörer | 11 | Vorwärts-Taste  |
| 2 | OK-/Menü-Taste  | 12 | optische Rufanzeige (Anruf-LED) |
| 3 | Display | 13 | Mikrofon |
| 4 | Zurück-Taste  | 14 | Freisprech-Taste  |
| 5 | Direktwahl-Tasten   | 15 | Raute-Taste  |
| 6 | Ein-/Aus-Taste Anrufbeantworter  | 16 | R-/Lösch-Taste  |
| 7 | Aufwärts-Taste, Anruferliste  | 17 | Wahlwiederholung-Taste  |
| 8 | Wiedergabe-/Stopp-Taste  | 18 | INT-Taste  |
| 9 | Abwärts-Taste, Telefonbuch  | 19 | Stern-Taste  |
| 10 | Rückwärts-Taste  | 20 | Numerische Tasten  ,  ,  usw. |

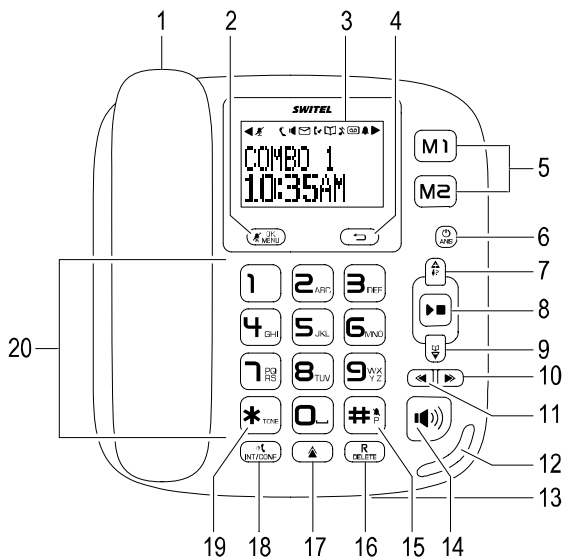







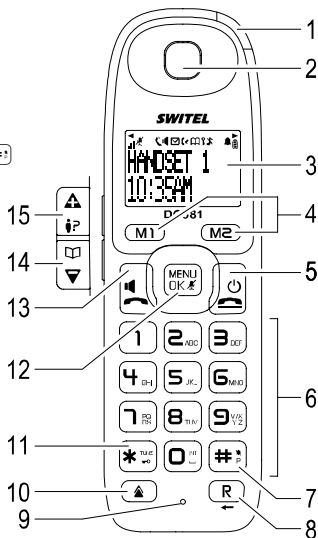







Bedienelemente

Mobilteil

- 1 optische Rufanzeige (Anruf-LED)
- 2 Hörmuschel
- 3 LC-Display
- 4 Direktwahl-Tasten (M1) (M2)
- 5 Auflegen-/Ein-/Aus-Taste (ON)
- 6 Numerische Tasten (1) (2)... bis (0)
- 7 Raute-Taste / Rufton aus / Wahlpause (**)
- 8 R-Taste / Zurück (R)
- 9 Mikrofon
- 10 Wahlwiederholung (A)
- 11 Stern-Taste (*)
- 12 Menü-/OK-/Stumm-Taste (MENU/OK/)
- 13 Gespräch-Taste / Freisprechen (H)
- 14 Pfeil-Taste runter / Telefonbuch (D)
- 15 Pfeil-Taste rauf / Anrufliste (U)



Symbole und Texte in den Displays











Symbol	Beschreibung
	Anzeige der Akkukapazität (voll, halbvoll, fast leer). Leer: Die Akkus müssen geladen werden. Durchlaufende Segmente: Die Akkus werden geladen ☞ Seite 8. Konstant angezeigte Segmente: Die Akkus sind voll geladen.
	Verbindung zur Basisstation. Blinkend: Schwache bzw. keine Verbindung. Konstant: Gute Verbindung.
	Blinkend: Ein Anruf geht ein ☞ Seite 21. Konstant: Sie führen ein Gespräch ☞ Seite 21.
	Verpasste Anrufe. Es sind neue Anrufe in der Anrufliste ☞ Seite 29.
	Sie befinden sich im Telefonbuch ☞ Seite 25.
	Der Eintrag bzw. die Anzeige geht zur rechten Seite weiter ☞ Seite 26.
	Der Eintrag bzw. die Anzeige geht zur linken Seite weiter ☞ Seite 26.
	Konstant: Anrufbeantworter ist an ☞ Seite 33. Blinkend: Neue Nachrichten auf dem Anrufbeantworter ☞ Seite 35. Oder: Die Speicherkapazität des Anrufbeantworters ist erschöpft. Löschen Sie Nachrichten ☞ Seite 36
	Der Rufton ist ausgeschaltet ☞ Seite 24.
	Das Mikrofon ist stummgeschaltet ☞ Seite 25.
	Das Freisprechen ist aktiviert ☞ Seite 25.
	Die Tastensperre ist aktiviert ☞ Seite 21.
	Der Wecker ist eingeschaltet ☞ Seite 31.
	Anrufbeantworter im Telefonnetz. VMWI - Zusatzdienst Ihres Netzbetreibers ☞ Seite 43.

Einführende Informationen

4 Einführende Informationen

In diesem Kapitel finden Sie grundlegende Informationen zur Handhabung der Bedienungsanleitung.

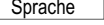
Darstellungsweisen in der Bedienungsanleitung

Darstellung	Beschreibung
	Darstellung von Tasten
	Abgebildete Taste kurz drücken
	Beliebige Taste kurz drücken
2 Sek. 	Abgebildete Taste 2 Sekunden drücken
	Ziffern oder Buchstaben eingeben
	Mobilteil klingelt
	Telefon klingelt
	Hörer abnehmen bzw. Mobilteil aus der Ladestation nehmen
	Hörer auflegen bzw. Mobilteil in die Ladestation stellen
	Darstellung von Display-Texten
	Darstellung von Display-Symbolen
MT1, MT2	Mobilteil 1, Mobilteil 2 usw.
BS	Basisgerät

Bereitschaftsmodus (Stand-by-Modus)

Alle Beschreibungen in dieser Bedienungsanleitung gehen davon aus, dass sich Telefon (Basisstation) und Mobilteil im Bereitschaftsmodus (Stand-by-Modus) befinden. Telefon (Basisstation) und Mobilteil sind im Bereitschaftsmodus, wenn kein Gespräch geführt wird und kein Menü geöffnet ist.

Navigation im Menü

Alle Funktionen sind über unterschiedliche Menüs zu erreichen. Den Weg zur gewünschten Funktion entnehmen Sie der Menüstruktur  Seite 14.



Jeder Vorgang wird automatisch abgebrochen, wenn innerhalb von 20 Sekunden keine Eingabe erfolgt.



Hauptmenü öffnen



Gewünschtes Untermenü auswählen

¹ Die Zifferntasten sind mit Buchstaben beschriftet. Durch mehrmaliges Drücken der entsprechenden Taste können Buchstaben, Ziffern und Sonderzeichen eingegeben werden.

Einführende Informationen

	Untermenü öffnen
	Gewünschte Funktion auswählen
	Funktion öffnen
	Gewünschte Einstellung auswählen
	Über Zifferntastenblock Ziffern oder Buchstaben eingeben
	Eingaben bestätigen
	Eine Ebene zurück im Menü
	Programmier- und Speichervorgänge abbrechen und in den Bereitschaftsmodus zurückkehren



Viele Eingaben, die mit Taste abgeschlossen werden, werden durch einen akustischen Signalton bestätigt.

Telefonbucheinträge erstellen - Beispiel

Wie Sie in den Menüs navigieren und Einstellungen vornehmen, ist hier anhand des Beispiels **Telefonbucheinträge erstellen** (Mobilteil) erklärt. Verfahren Sie bei allen Einstellungen wie in diesem Beispiel.







	Hauptmenü öffnen
Telefonbuch	Telefonbuch öffnen
Hinzufügen	Untermenü auswählen und bestätigen
Name eing.	Namen eingeben (max. 12 Stellen) und bestätigen
Nummer	Rufnummer 1 (Handy-Nummer) eingeben (max. 24 Ziffern) und bestätigen
Nummer	Rufnummer 2 (Festnetz-Nummer) eingeben (max. 24 Ziffern) und bestätigen
VIP-Melodie	Klingelton zuweisen
	Zurück in den Bereitschaftsmodus



Pro Namen bzw. Eintrag können 2 Telefonnummern gespeichert werden. Dem ersten Speicherplatz ist ein Handy-Symbol vorangestellt, dem zweiten Speicherplatz ein Haus-Symbol. Wir empfehlen deshalb, bei dem ersten Speicherplatz nur Handy-Nummern zu programmieren und beim zweiten Speicherplatz nur Festnetz-Nummern.

Menüstruktur

5 Menüstruktur

In das Hauptmenü gelangen Sie, wenn Sie die Taste  bzw.  drücken. Danach wählen Sie mit den Tasten  /  einen Eintrag aus und bestätigen Sie Ihre Auswahl mit der Taste  bzw. . Weitere Informationen zum Menü und zur Bedienung  Kapitel 4.

AB

AB-Modus	
	Antw.+Aufn.
	Nur antw.
	Aus
Alte löschen	
Memo aufn.	
Ansage 1	
	Ansage anh.
	Löschen
	Ansage aufn.
Ansage 2	
	Ansage anh.
	Löschen
	Ansage aufn.
Mithören	Ein / Aus
Rufannahme	
	Gebührsparer
	08 Klingeln
	06 Klingeln
	04 Klingeln
	02 Klingeln

Nachr.länge

180 Sekunden

150 Sekunden

120 Sekunden

90 Sekunden

Spracheinst.

DEUTSCH

FRANÇAIS

NEDERLANDS

ITALIANO

Fernabf.-PIN

Intercom



Mobilteil 01 - 06 ¹

¹ Anzeige gemäß der Anzahl von angemeldeten Mobilteilen



Menüstruktur

Telefonbuch

Hinzufügen

Name eing.	 ¹
Nummer	
Nummer	
VIP-Melodie	01 / 02 / ... / Aus

Bearbeiten

Name eing.	 ¹
Nummer	
Nummer	
VIP-Melodie	01 / 02 / ... / Aus

Löschen

Alle löschen

Kopieren auf

Direktwahl 1
Direktwahl 2

SPEICHER

¹ Die Zifferntasten sind mit Buchstaben beschriftet. Durch mehrmaliges Drücken der entsprechenden Taste können Buchstaben, Ziffern und Sonderzeichen eingegeben werden.

Zeit/Wecker

Wecker st.

Einmal

Aus

Ein Zeit eing. 

Täglich

Aus

Ein Zeit eing. 

Datumsformat

TT.MM

MM-TT

Zeitformat

24 Stunden

12 Stunden

Zeit einst. ¹





¹ Über diesen Menüpunkt werden Datum und Zeit eingestellt.

Menüstruktur

Nur an einem Mobilteil verfügbar:

MT-Einstell. ¹

Rufton (MT)	
	Ruftonlautst 05 / ... / 01 / Aus
	Rufton (ext) 12 / ... / 01
	Rufton (int) 12 / ... / 01
	Tastenton Aus / Ton ein / Rufton
	Akku schwach Ein / Aus
	Reichw.alarm Ein / Aus
Equalizer	
	Natürlich
	Tiefen
	Höhen
LCD-Kontrast	06 / ... / 01
MT-Name  ²	
Auto.Annahme	Ein / Aus
Babyruf	
	Aus
	Ein Nr. eing. 
Tastensperre	Ein / Aus
Sprache	(9 Sprachen)

¹ Dieser Menüpunkt wird nur im Mobilteil angezeigt.

² Die Zifferntasten sind mit Buchstaben beschriftet. Durch mehrmaliges Drücken der entsprechenden Taste können Buchstaben, Ziffern und Sonderzeichen eingegeben werden.

Nur an einem Mobilteil verfügbar:

Basis-Einst. ¹

VMWI löschen

Anmelden

Basis 1	PIN? ²
---------	-------------------

Basis 2	PIN? ²
---------	-------------------

Basis 3	PIN? ²
---------	-------------------

Basis 4	PIN? ²
---------	-------------------

Basis wählen

Basis 1

Basis 2

Basis 3

Basis 4

Automatisch

Erw. Einst.

Wahlverf.	MFV / IWV
-----------	-----------

Flashzeit	Kurz / Mittel / Lang
-----------	----------------------

Vorwahlnr.	
------------	---

Anrufsperr	04 / ... / 01  Nr. eing. 
------------	--

Notruf-Nr.	04 / ... / 01  Nr. eing. 
------------	--

Abmelden	Mobilteil
----------	-----------

PIN ändern	PIN? 
------------	--

Zurücksetzen	Bestätigen?
--------------	-------------







¹ Dieser Menüpunkt wird mit genau den Untermenüs nur im Mobilteil angezeigt.

² Die PIN ist werkseitig auf "0000" eingestellt.

Menüstruktur

Nur am Basisgerät verfügbar:

Basis-Einst.¹

Rufton		
	Ruftonlautst	05 / ... / 01 / Aus
	Rufton (ext)	12 / ... / 01
	Rufton (int)	12 / ... / 01
	Tastenton	Aus / Ton ein / Rufton
LCD-Kontrast	06 / ... / 01	
VMWI löschen	06 / ... / 01	
Sprache	(9 Sprachen)	
Anmelden		
	Basis 1	PIN? ²
	Basis 2	PIN? ²
	Basis 3	PIN? ²
	Basis 4	PIN? ²
Erw. Einst.		
	Wahlverf.	MFV / IWV
	Flashzeit	Kurz / Mittel / Lang
	VorwahlNr.	
	Anrufsperr	04 / ... / 01  Nr. eing. 
	Notruf-Nr.	04 / ... / 01  Nr. eing. 
	Abmelden	Mobilteil
	PIN ändern	PIN? 
	Zurücksetzen	Bestätigen?

¹ Dieser Menüpunkt wird mit genau den Untermenüs nur im Basisgerät angezeigt.

² Der PIN-Code ist werkseitig auf "0000" eingestellt.

6 Bedienung

Viele Funktionen können sowohl vom Basisgerät als auch vom Mobilteil aus bedient werden. Beachten Sie, dass viele der nachfolgend dargestellten Tasten sowohl am Basisgerät als auch am Mobilteil zu finden sind ➔ Seite 9.



Sie können während einer Bedienabfolge nicht zwischen der Bedienung am Basisgerät und der Bedienung am Mobilteil wechseln. Entscheiden Sie vor Beginn einer Bedienabfolge, ob Sie diese am Basisgerät oder am Mobilteil durchführen wollen.

Mobilteil ein- und ausschalten

Wenn das Mobilteil ausgeschaltet ist, gehen am Mobilteil keine Anrufe ein.

Bei ausgeschaltetem Mobilteil wird keine Akkuleistung verbraucht.



Bei ausgeschaltetem Mobilteil können von diesem keine Notrufe durchgeführt werden. Zuvor muss das Mobilteil eingeschaltet werden, was einige Zeit dauern kann.

2 Sek.

Mobilteil einschalten (in den Bereitschaftsmodus)

2 Sek.

Mobilteil ausschalten

Tastensperre

Die Tastensperre soll verhindern, dass versehentlich Funktionen ausgelöst werden.

1 Sek.

Tastensperre einschalten



Bei eingeschalteter Tastensperre können eingehende Anrufe wie gewohnt angenommen werden. Auch Notrufe (über die Notruf-Nummern) können bei aktivierter Tastensperre durchgeführt werden.

1 Sek.

Tastensperre ausschalten

Ist die Tastensperre eingeschaltet, wird im Display das Symbol angezeigt.

Das Telefon kann so eingestellt werden, dass sich die Tastensperre automatisch nach 90 Sekunden einschaltet ➔ Seite 31.

Telefonieren

Anruf annehmen

Neben dem Rufsignal leuchtet bei jedem Anruf auch die optische Rufanzeige.

), oder

Anruf annehmen



Halten Sie das klingelnde Mobilteil nicht zu dicht an Ihre Ohren, es besteht die Gefahr eines Hörschadens!

Wenn Sie die automatische Rufannahme aktiviert haben, nehmen Sie einen Anruf an, indem Sie das Mobilteil aus der Ladestation herausnehmen ➔ Seite 31.

Gespräch beenden

oder

Gespräch beenden



Zum Beenden eines Gesprächs können Sie das Mobilteil auch in die Ladestation stellen.

Bedienung

Anrufen







	Rufnummer eingeben (max. 48 Ziffern)
	Bei Falscheingabe letzte Ziffer löschen
 oder  oder 	Rufnummer wählen



Sie können auch zuerst am Mobilteil die Taste  drücken bzw. am Basisgerät den Hörer abnehmen oder die Taste  drücken und erhalten damit das Freizeichen. Die eingegebenen Ziffern Ihrer gewünschten Rufnummer (max. 48 Ziffern) werden sofort gewählt. Eine Korrektur einzelner Ziffern der Rufnummer ist bei dieser Form des Gesprächsaufbaus nicht möglich.

Wahlwiederholung







Ihr Telefon speichert die 5 zuletzt gewählten Rufnummern mit Anruftdatum und -uhrzeit. Möchten Sie diese Rufnummern noch einmal wählen, z. B. weil der Anschluss zuvor besetzt war oder Sie niemanden erreichen konnten, nutzen Sie die Wahlwiederholung:

 ,  / 	Wahlwiederholungsliste öffnen und Eintrag auswählen
 oder  oder 	Verbindung herstellen

Die gespeicherte Rufnummer wird automatisch gewählt und die Verbindung wird hergestellt.







Eingegangene Anrufe zurückrufen

Ihr Telefon speichert 40 Rufnummern in einer Anrufliste.

 ,  / 	Anrufliste öffnen und Eintrag auswählen
 oder  oder 	Verbindung herstellen

Rufnummern aus dem Telefonbuch wählen

Sie müssen Rufnummern im Telefonbuch gespeichert haben  Seite 26.

 ,  / 	Telefonbuch öffnen und Eintrag auswählen
 oder  oder 	Verbindung herstellen



Um auf einen Telefonbucheintrag schneller zugreifen zu können, drücken Sie im geöffneten Telefonbuch die Taste mit dem Anfangsbuchstaben des Eintrags. Der erste Eintrag mit diesem Anfangsbuchstaben wird nun im Display angezeigt und ist markiert.

Rufnummern über Direktwahltaste wählen

Sie müssen Rufnummern auf den Direktwahltasten gespeichert haben  Seite 27.

 oder 	Verbindung herstellen
--	-----------------------

Die gespeicherte Rufnummer wird automatisch gewählt.

Intern telefonieren

Sie müssen mindestens ein Mobilteil an dem Basisgerät angemeldet haben, um intern kostenlos zu telefonieren.

Interne Gespräche führen

MT1: oder BS:	
/ Intercom , oder	Internes Telefonieren einleiten
MT1/BS: / , oder	Gewünschtes Mobilteil bzw. Basisgerät auswählen
MT2:	Internes Gespräch am anderen Mobilteil annehmen
MT1/BS / MT2:	Internes Gespräch beenden



Wenn das Mobilteil, das Sie intern anrufen wollen, ein externes Telefongespräch führt, hören Sie einen Signalton und im Display sehen Sie Ltg. belegt.

Externe Gespräche während eines internen Telefonats annehmen



Wenn ein externer Anruf eingeht, während Sie ein internes Telefongespräch führen, wird eine Meldung im Display angezeigt.

	Externes Gespräch annehmen
Am Mobilteil, das das externe Gespräch nicht angenommen hat, die Taste drücken, um das interne Gespräch zu beenden.	

Externe Gespräche intern weiterleiten

MT1: oder BS:	
/ , Intercom , oder	Während des externen Gesprächs
/ , oder	Gewünschtes Mobilteil bzw. Basisgerät auswählen
MT2:	Internes Gespräch am anderen Mobilteil annehmen
MT1: oder BS:	Gespräch weiterleiten (Auflegen)

Rücksprache / Makeln

MT1: oder BS:	
/ , Intercom , oder	Während des externen Gesprächs
/ , oder	Gewünschtes Mobilteil bzw. Basisgerät auswählen
MT2:	Internes Gespräch am anderen Mobilteil annehmen
MT1: oder BS: , / Makeln	
oder	Gesprächspartner wechseln

Konferenzgespräche führen

Ein externes Gespräch kann mit einem weiteren internen Gesprächspartner zum Konferenzgespräch geschaltet werden.

MT1: oder BS:	
/ , Intercom ,	Während des externen Gesprächs
/ ,	Gewünschtes Mobilteil bzw. Basisgerät auswählen
MT2:	Internes Gespräch am anderen Mobilteil annehmen
MT1 oder BS: 2 Sek. , Konferenz	Konferenzgespräch starten
MT1 oder BS und MT2:	Konferenz beenden

Bedienung

Anzeige der Gesprächsdauer

Einige Sekunden nach Beginn eines Gesprächs zeigt Ihnen das Display die aktuelle Gesprächsdauer in Minuten und Sekunden an.

Hörerlautstärke einstellen

Sie können während eines Gesprächs die Hörerlautstärke in 5 Stufen anpassen.



Hörerlautstärke erhöhen / verringern

Ruftonlautstärke

Sie können jeweils separat für das Mobilteil und für das Basisgerät die Lautstärke des Ruftons verändern. Es stehen 5 Lautstärken zur Verfügung sowie die Möglichkeit, den Rufton auszuschalten.

Ruftonlautstärke des Mobilteils einstellen



Menü öffnen



MT-Einstell.



MT-Einstell. auswählen



Rufton (MT)



Rufton (MT) auswählen



Ruftonlautst



Ruftonlautst auswählen



Ruftonlautstärke erhöhen / verringern



Einstellung speichern

Ruftonlautstärke des Basisgeräts einstellen



Menü öffnen



Basis-Einst.



Basis-Einst. auswählen



Rufton



Rufton auswählen



Ruftonlautst



Ruftonlautst auswählen



Ruftonlautstärke erhöhen / verringern



Einstellung speichern

Rufton aus- und einschalten

3 Sek. **##1**

Rufton ausschalten

3 Sek. **##1**



Rufton einschalten

Ist der Rufton ausgeschaltet, wird im Display das Symbol  angezeigt.

Sie können den Rufton auch über das Menü ausschalten.

Freisprechen

Nutzen Sie diese Funktion, um den Gesprächspartner über den Lautsprecher zu hören.



 bzw.  Während eines Gesprächs: Freisprechen einschalten



 bzw.  Während eines Gesprächs: Freisprechen ausschalten

Ist das Freisprechen aktiviert, wird im Display das Symbol  angezeigt.

Mikrofon stummschalten

Sie können während eines Telefongesprächs das Mikrofon des Mobilteils bzw. des Basisgeräts aus- und einschalten, so dass Ihr Gesprächspartner am Telefon Sie nicht hört, z. B. wenn Sie mit einer anderen Person im Raum Rücksprache halten wollen.

2 Sek.  bzw.  Während eines Gesprächs: Mikrofon ausschalten (stummschalten)

2 Sek.  bzw.  Während eines Gesprächs: Mikrofon einschalten

Ist das Mikrofon stumm geschaltet, wird im Display das Symbol  angezeigt.

Telefonbuch

Im Telefonbuch können Sie 50 Gesprächspartner mit bis zu jeweils 2 Telefonnummern speichern.

- Geben Sie bei allen Rufnummern immer die Vorwahl mit ein, damit auch eingehende Ortsgespräche einem Telefonbucheintrag zugeordnet werden können.
- Ist die Speicherkapazität erschöpft, zeigt das Display beim nächsten Speichern die Meldung . Um wieder Platz zu schaffen, müssen Sie zuerst einen anderen Eintrag löschen.
- Die Telefonbucheinträge sind alphabetisch geordnet.

Befinden Sie sich im Telefonbuch, wird im Display das Symbol  angezeigt.

Auf das Telefonbuch kann vom Basisgerät und vom Mobilteil zugegriffen werden.

Namen eingeben

Die Zifferntasten sind mit Buchstaben beschriftet. Durch mehrmaliges Drücken der entsprechenden Taste können Buchstaben, Ziffern und Sonderzeichen eingegeben werden.

 Leerzeichen eingeben

 Sonderzeichen eingeben

 Löschen

 /  Cursor bewegen



Um den gleichen Buchstaben zweimal einzugeben, drücken Sie die entsprechende Taste. Warten Sie, bis der Cursor eine Stelle weitergesprungen ist. Geben Sie den Buchstaben erneut ein.

Bedienung

Telefonbucheinträge erstellen

auch Seite 13

	Telefonbuch öffnen	
bzw.	Hinzufügen	
bzw.	Untermenü auswählen und bestätigen	
Name eing.	bzw.	Namen eingeben (max. 12 Stellen) und bestätigen
Nummer	bzw.	Rufnummer 1 (Handy-Nummer) eingeben (max. 24 Ziffern) und bestätigen
Nummer	bzw.	Rufnummer 2 (Festnetz-Nummer) eingeben (max. 24 Ziffern) und bestätigen
VIP-Melodie	/ / , bzw.	Klingelton zuweisen

Sind die Einträge länger, als sie im Display dargestellt werden können, werden im Display die Symbole ◀ und ▶ angezeigt. Sie zeigen an, dass der Eintrag nach links oder rechts über das Display hinausgeht.

Ist die Speicherkapazität erschöpft, zeigt das Display beim nächsten Speichern die Meldung

Sp. voll!. Um wieder Platz zu schaffen, müssen Sie zuerst einen anderen Eintrag löschen.









Ist ein Name bereits vorhanden, unter dem Sie einen neuen Eintrag abspeichern wollen, zeigt das Display beim Speichern die Meldung **Name doppelt**.

Telefonbucheinträge ändern

	Telefonbuch öffnen	
/ / bzw.	Eintrag auswählen und bestätigen	
/ , Bearbeiten	bzw.	Untermenü auswählen und bestätigen
Name eing.	bzw.	Namen ändern (max. 12 Stellen) und bestätigen
Nummer	bzw.	Rufnummer 1 (Handy-Nummer) ändern (max. 24 Ziffern) und bestätigen
Nummer	bzw.	Rufnummer 2 (Festnetz-Nummer) ändern (max. 24 Ziffern) und bestätigen
VIP-Melodie	/ / , bzw.	Klingelton zuweisen

Telefonbucheinträge löschen











Einen Eintrag löschen

	Telefonbuch öffnen
 /  ,  bzw. 	Eintrag auswählen und bestätigen
 /  , Löschen  bzw. 	Untermenü auswählen und bestätigen









Um auf einen Telefonbucheintrag schneller zugreifen zu können, drücken Sie im geöffneten Telefonbuch die Taste mit dem Anfangsbuchstaben des Eintrags. Der erste Eintrag mit diesem Anfangsbuchstaben wird nun im Display angezeigt und ist markiert.

Alle Einträge löschen

	Telefonbuch öffnen
 bzw. 	Menü öffnen
 /  , Alle löschen  bzw. 	Untermenü auswählen und bestätigen
Bestätigen? ,  bzw. 	
Kein Eintr.	Löschvorgang bestätigen
oder	
Bestätigen? , R oder 	Löschvorgang abbrechen















Telefonbuchkapazität prüfen

Lassen Sie sich anzeigen, wie viele der 50 Speicherplätze belegt sind.

	Telefonbuch öffnen
 bzw. 	Menü öffnen
 /  , SPEICHER  bzw. 	Untermenü auswählen und bestätigen

Direktwahl-Tasten programmieren

Sie haben die Möglichkeit, 2 Telefonnummern aus dem Telefonbuch so abzuspeichern, dass diese jeweils nur durch den Druck von Taste **M1** oder **M2** gewählt werden (Direktwahl).

	Telefonbuch öffnen
 /  ,  bzw. 	Eintrag auswählen und bestätigen
 /  , Kopieren auf  bzw. 	Untermenü auswählen und bestätigen
Direktwahl 1 ,  /  ,  bzw. 	Direktwahl Taste auswählen und bestätigen
 bzw. 	Angezeigte Telefonnummer bestätigen

Rufnummer über Direktwahl Taste wählen



















 Seite 22

Bedienung









Wahlwiederholungsliste

Ihr Telefon speichert die 5 zuletzt gewählten Rufnummern mit Anrufdatum und -uhrzeit.











Rufnummer aus der Wahlwiederholungsliste im Telefonbuch abspeichern

- | | |
|---|--|
|  | Wahlwiederholungsliste öffnen |
|  /  ,  bzw.  | Eintrag auswählen und bestätigen |
|  /  , Nr. speichern  bzw.  | Untermenü auswählen und bestätigen |
| Name eing.   bzw.  | Namen eingeben (max. 12 Stellen) und bestätigen |
| Nr. eing.   bzw.  | Rufnummer gegebenenfalls ändern (max. 24 Ziffern) und bestätigen |
|  /  ,  bzw.  | Festlegen, ob die Rufnummer eine Handy-Nummer oder eine Festnetz-Nummer ist und bestätigen |

Rufnummer aus der Wahlwiederholungsliste löschen

- | | |
|---|------------------------------------|
|  | Wahlwiederholungsliste öffnen |
|  /  ,  bzw.  | Eintrag auswählen und bestätigen |
|  /  , Löschen  bzw.  | Untermenü auswählen und bestätigen |

Gesamte Wahlwiederholungsliste löschen

- | | |
|--|------------------------------------|
|  | Wahlwiederholungsliste öffnen |
|  bzw.  | Menü öffnen |
|  /  , Alle löschen  bzw.  | Untermenü auswählen und bestätigen |
| Bestätigen?  bzw.  | |
| Kein Eintr. | Löschvorgang bestätigen |
| oder | |
| Bestätigen?  oder  | Löschvorgang abbrechen |

Rufnummer aus der Wahlwiederholungsliste wählen

 Seite 22

Anrufliste

Während Ihrer Abwesenheit werden alle eingehenden Anrufe in einer Anrufliste gesammelt. Insgesamt können dort bis zu 40 Rufnummern gespeichert werden. Für jeden Anruf werden Datum und Uhrzeit des Eingangs festgehalten.

Befinden Sie sich in der Anrufliste, wird im Display das Symbol angezeigt.

In der Anrufliste wird der zuletzt eingegangene Anruf zuerst aufgelistet.

Wurden während Ihrer Abwesenheit Anrufe registriert, blinkt die optische Rufanzeige und im Display das Symbol . Im Display wird außerdem bis zum ersten Öffnen der Anrufliste ein Hinweis angezeigt, wie viele Anrufe Ihnen entgangen sind.

Rufnummern aus der Anrufliste anzeigen

Anrufliste öffnen und Eintrag auswählen

Rufnummer aus der Anrufliste im Telefonbuch speichern

Eine Rufnummer kann direkt aus der Anrufliste im Telefonbuch gespeichert werden.

Anrufliste öffnen und Eintrag auswählen

bzw. Menü öffnen

Nr. speichern, bzw. Untermenü auswählen und bestätigen

Name eing. bzw. Namen eingeben (max. 12 Stellen) und bestätigen

Nr. eing. bzw. Rufnummer gegebenenfalls ändern (max. 24 Ziffern) und bestätigen

bzw. Festlegen, ob die Rufnummer eine Handy-Nummer oder eine Festnetz-Nummer ist und bestätigen

Rufnummern aus der Anrufliste löschen

Einzelne Rufnummer löschen

Anrufliste öffnen und Eintrag auswählen

bzw. Menü öffnen

Löschen, bzw. Untermenü auswählen und bestätigen

Alle Rufnummern löschen

Anrufliste öffnen

bzw. Menü öffnen

Alle löschen bzw. Untermenü auswählen und bestätigen

Bestätigen?, bzw. **Kein Eintr.**
Löschvorgang bestätigen

oder

Bestätigen?, oder Löschvorgang abbrechen

Eingegangene Anrufe zurückrufen

Bedienung

Ton- und Anzeigeeinstellungen

Sie können verschiedene Einstellungen vornehmen, um das Telefon Ihren Bedürfnissen entsprechend einzurichten:

Rufton einstellen

Legen Sie für externe und für interne Anrufe den grundsätzlich zu verwendenden Rufton fest. Es stehen insgesamt 12 polyphone Ruftöne zur Verfügung.

Rufton einstellen ☞ Menü Seite 18

Tastentöne

Tastentöne geben Ihnen eine Bestätigung, dass Sie eine Taste wirklich gedrückt haben. Das Telefon kann so eingestellt werden, dass beim Drücken einer beliebigen Taste immer der gleiche Tastenton ertönt (Einstellung Ton ein), oder dass unterschiedliche Tastentöne erzeugt werden (Einstellung Rufton). Außerdem können die Tastentöne ausgeschaltet werden.

Tastentöne einstellen ☞ Menü Seite 18

Warnton Akkukapazität

Ein Warnton macht darauf aufmerksam, dass die Kapazität der Akkus schwach ist.

Warnton Akkukapazität (Akku schwach) einstellen ☞ Menü Seite 18

Warnton Reichweite

Ein Warnton macht darauf aufmerksam, dass Sie sich mit dem Mobilteil aus der Reichweite des Basisgeräts entfernen.

Warnton Reichweite (Reichw. alarm) einstellen ☞ Menü Seite 18

Equalizer

Passen Sie den Klang des Lautsprechers Ihren Wünschen an. Belassen Sie den Klang Natürlich oder heben Sie Tiefen oder Höhen hervor.

Equalizer einstellen ☞ Menü Seite 18

Display-Kontrast

Der Kontrast des Displays (LCD-Kontrast) von Basisgerät und von Mobilteil kann in 6 Stufen verändert werden ☞ Menü Seiten 18 und 20

Mobilteilname

Sie können dem Mobilteil einen individuellen Namen geben (MT-Name) ☞ Menü Seite 18

Zeit- und Datumsformat

Legen Sie fest, in welchem Format und in welcher Reihenfolge Zeit und Datum angezeigt werden sollen ☞ Menü Seite 17

Sonstige Einstellungen

Automatische Rufannahme

Haben Sie diese Funktion aktiviert, wird ein Anruf automatisch beim Herausnehmen des Mobilteils aus der Ladestation angenommen. Die automatische Anrufannahme wird über das Menü aktiviert oder deaktiviert.

Automatische Rufannahme aktivieren  Menü Seite 18





Der Menüpunkt Auto.Annahme kann nur über das Menü eines Mobilteils aufgerufen werden.

Tastensperre

Ist diese Einstellung aktiviert, schaltet sich automatisch die Tastensperre ein, wenn 90 Sekunden keine Taste gedrückt wurde. Ist die Tastensperre eingeschaltet, wird im Display das Symbol  angezeigt.

Tastensperre aktivieren  Menü Seite 18

Vorwahlnummer

Sie können eine Vorwahlnummer hinterlegen (VorwahlNr.). Durch langes Drücken der Taste  bevor oder nachdem Sie die Rufnummer eingegeben haben, wird die Vorwahlnummer der Rufnummer vorangestellt. Durch Betätigen der Taste  wird diese Rufnummer gewählt.

Vorwahlnummer ändern  Menü Seite 19

PIN ändern

Die PIN wird zum Anmelden von Mobilteilen benötigt. Sie ist werkseitig auf "0000" eingestellt. PIN ändern  Menü Seite 19 (Menü des Basisgeräts)

Zurücksetzen

Mit dieser Funktion haben Sie die Möglichkeit, Ihr Telefon auf Werkseinstellungen zurückzusetzen. Zurücksetzen  Menü Seiten 19 und 20

Mobilteil suchen (Paging)

Wenn Sie Ihr Mobilteil verlegt haben, können Sie es leicht wiederfinden, indem Sie das Mobilteil vom Basisgerät aus anrufen.



Bedingungen: Das Mobilteil ist angeschaltet, befindet sich in Reichweite des Basisgeräts, die Akkus sind nicht leer und der Rufton des Mobilteils ist nicht ausgeschaltet. Letzteres bedeutet, im Display des Mobilteils darf das Symbol  NICHT angezeigt sein.

BS: 

Internes Anrufen einleiten

BS:  / 

zu suchendes Mobilteil auswählen

BS: 

Suchanruf starten

Besondere Funktionen

Wecker

Mit dieser Funktion können Sie sich zu einer bestimmten Zeit von Ihrem Mobilteil wecken bzw. erinnern lassen. Ist der Wecker eingeschaltet, wird im Display das Symbol  angezeigt. Zur eingestellten Weckzeit wird der gewählte Rufton für 1 Minute abgespielt. Im Display wird der Hinweis

Bedienung

Wecker angezeigt.

Wecker stellen

Sie können wählen, ob Sie den Wecker nur für eine Weckaktion stellen wollen (Einmal) oder ob Sie Ihr Telefon täglich zur gleichen Zeit wecken soll (Täglich).



Wecker einstellen (Wecker st.) ➤ Menü Seite 17

Weckruf vorzeitig beenden



Weckruf beenden

Babyruf

Mit dieser Funktion haben Sie die Möglichkeit, eine bestimmte Rufnummer (max. 24 Ziffern) zu speichern, die bei Betätigen einer beliebigen Taste (außer den Tasten  und ) automatisch mit der Freisprechfunktion angerufen wird.

Ist die Funktion eingeschaltet, blinkt im Display dauerhaft die Anzeige **Babyruf**.

Babyruf aktivieren ➤ Menü Seite 18

Anrufsperre

Die Anrufsperre hindert Mobilteile daran, Rufnummern zu wählen, die mit den von Ihnen hinterlegte Ziffern beginnen. Sie können 4 Sperrnummern mit jeweils max. 8 Ziffern hinterlegen.

Anrufsperre aktivieren ➤ Menü Seite 19

Wird eine gesperrte Rufnummer gewählt, wird keine Verbindung hergestellt. Das Gerät gibt einen Warnton ab und kehrt in den Bereitschaftsmodus zurück.

Notruf-Nummer

Sie können bis zu 4 Rufnummern hinterlegen, die trotz aktivierter Anrufsperre gewählt werden können. Auf Seite 19 finden Sie die Position im Menü.

Wahlverfahren

Sie können Ihr Mobilteil sowohl an den analogen Vermittlungsstellen (Impulswahl-Verfahren / IWV) als auch an den neuen digitalen Vermittlungsstellen (Tonwahl-Verfahren / MFV) betreiben. Das Wahlverfahren wird über das Menü eingestellt. Auf Seite 19 finden Sie die Position im Menü.



Wenn Sie das Telefon im Impulswahl-Verfahren betreiben, können Sie während eines Gesprächs durch Drücken der Taste  für den Rest des Gesprächs in das Tonwahl-Verfahren umschalten.

Rufnummernanzeige (CLIP)



Die Rufnummernanzeige (CLIP) sowie die Anzeige von Datum und Uhrzeit sind optionale Dienste Ihres Netzbetreibers. Bitte fragen Sie diesen nach weiteren Informationen.

Steht Ihrer Telefonanlage die CLIP-Funktion zur Verfügung (CLIP = Calling Line Identification Presentation), zeigt das Display bei einem eingehenden Anruf die Rufnummer des Anrufers an, soweit dieser der Rufnummerübertragung zugestimmt hat.



Nehmen Sie einen Anruf nicht an, bleibt die Anzeige für ca. 6 Sekunden im Display, bevor anschließend wieder die aktuelle Uhrzeit und das Datum angezeigt werden.

7 Anrufbeantworter

Der Anrufbeantworter speichert bis zu 57 Nachrichten (59 Nachrichten inklusive Ansagetexte). Die maximale Aufnahmezeit beträgt 15 Minuten (inklusive Ansagetexte).

Ist die Speicherkapazität für neue Nachrichten erschöpft, wird kein Anruf mehr aufgezeichnet. Der Anrufbeantworter wechselt dann automatisch in den Nur-Ansage-Modus.

Der Anrufbeantworter kann vom Basisgerät und vom Mobilteil aus bedient werden.

Anrufbeantworter ein-/ausschalten

Ist der Anrufbeantworter eingeschaltet, ist die Wiedergabe-/Stopp-Taste am Basisgerät rot beleuchtet. Außerdem wird im Display vom Basisgerät und den angemeldeten Mobilteilen das Symbol  dauerhaft angezeigt.



Werkseitig ist der Anrufbeantworter eingeschaltet.

Anrufbeantworter vom Basisgerät ein-/ausschalten



Anrufbeantworter ein-/ausschalten

Anrufbeantworter vom Mobilteil einschalten

/ **AB**, / **AB-Modus**, / **Antw.+Aufn.** oder **Nur antw.**

Menü Seite 14

Anrufbeantworter vom Mobilteil ausschalten

/ **AB**, / **AB-Modus**, / **Aus**,

Menü Seite 14

Antwortmodi

Ihr Anrufbeantworter stellt Ihnen zwei Antwortmodi zur Verfügung: Den Ansage-und-Aufnahme-Modus (Antw.+Aufn.) und den Nur-Ansage-Modus (Nur antw.). Im Ansage-und-Aufnahme-Modus kann eine Nachricht hinterlassen werden. Beim Nur-Ansage-Modus kann keine Nachricht hinterlassen werden.

Antwortmodus wählen

Wählen Sie den gewünschten Modus aus Menü Seite 14. Siehe auch Abschnitt "Anrufbeantworter ein-/ausschalten" auf Seite 33.



Werkseitig ist bei dem Anrufbeantworter der Ansage-und-Aufnahme-Modus aktiv.

Anrufbeantworter

Ansagetext

Ihr Anrufbeantworter stellt Ihnen zwei voreingestellte Ansagetexte zur Verfügung. Sie können beide Ansagetexte durch eigene Texte ersetzen.

Im Ansage-und-Aufnahme-Modus wird Ansagetext **Ansage 1** verwendet, im Nur-Ansage-Modus wird Ansagetext **Ansage 2** verwendet.



Sobald Sie einen eigenen Ansagetext aufzeichnen, wird nur noch dieser Ansagetext verwendet.

Ist der Speicher des Anrufbeantworters voll, wird automatisch der Ansagetext des Nur-Ansage-Modus wiedergegeben.

Sprache der Ansagetexte

Sie können die Sprachausgabe der Standardansagetexte des Anrufbeantworters ändern. Es stehen 4 Sprachen zur Verfügung.

oder / / **AB**,

oder / / **Spracheinst.**,

oder Untermenü öffnen

/ , oder Sprache auswählen und bestätigen

Ansagetext anhören

Menü Seite 14 (Ansage anh.)

Eigenen Ansagetext aufzeichnen

Ein selbst aufgezeichneter Ansagetext darf maximal 2 Minuten lang sein.

oder / / **AB**,

oder Untermenü auswählen

/ **Ansage 1**

oder **Ansage 2** oder Ansagetext auswählen

, / **Ansage aufn.**,

oder Aufzeichnung beginnen

Ansagetext aufsprechen

oder Aufzeichnung beenden und speichern

Sprechen Sie den von Ihnen gewünschten Text klar und deutlich in das Mikrofon von Basisgerät (an der Vorderseite des Geräts) oder von Mobilteil. Nach Beendigung wird Ihre Ansage laut wiederholt.



Achten Sie darauf, die Ansagetexte ausreichend lang aufzusprechen (max. 2 Minuten), wenn Sie die Funktionen der Fernabfrage nutzen möchten "Fernabfrage" Seite 38.

Standardansagetext wieder aktivieren

Das Löschen des selbst aufgesprochenen Ansagetextes aktiviert den Standardansagetext.

Das Löschen eines Ansagetextes erfolgt über das Menü  Menü Seite 14 (Löschen).



Standardansagetexte können nicht gelöscht werden.

Aufgezeichnete Nachrichten wiedergeben

Sind neue Nachrichten vorhanden, blinken am Basisgerät und den angemeldeten Mobilteilen die optischen Rufanzeigen und im jeweiligen Display das Symbol . Im Display von Basisgerät und den angemeldeten Mobilteilen wird zusätzlich ein textlicher Hinweis auf die Anzahl neuer Nachrichten angezeigt.

Die eingegangenen Nachrichten werden in der Reihenfolge des Eingangs nummeriert.





Die eingegangenen Nachrichten werden in umgekehrter Reihenfolge wiedergegeben: die zuletzt aufgezeichnete Nachricht wird zuerst abgespielt.

Während der Wiedergabe wird die Nummer der Nachricht sowie das Datum und die Zeit der Aufnahme angezeigt.























Es werden erst nur die neuen Nachrichten wiedergegeben. Zum Anhören der alten Nachrichten starten Sie die Wiedergabe der Nachrichten ein weiteres Mal.

Nachrichten am Basisgerät wiedergeben (über Lautsprecher)

	Nachrichten abhören/stoppen
	Nachricht wiederholen
2x 	Vorherige Nachricht
	Nächste Nachricht

Nachrichten am Mobilteil wiedergeben

  /  Anhören ,	
 Bitte warten	Nachrichten wiedergeben (über Lautsprecher)
Optionen während der Wiedergabe:	
	Menü öffnen
 /  Löschen  Gelöscht!	Nachricht löschen
 /  Stopp 	Wiedergabe stoppen
 /  Weiter 	Nächste Nachricht
 /  Wiederholen 	Aktuelle Nachricht von vorne wiedergeben
 /  Zurück 	Vorherige Nachricht

Anrufbeantworter

Alternativ können diese Funktionen auch über das Drücken bestimmter Tasten erzeugt werden:



	Nachricht löschen
	Aktuelle Nachricht von vorne wiedergeben
2x 	Vorherige Nachricht
	Wiedergabe stoppen (Pause)
	Nächste Nachricht

Lautstärke für Nachrichtenwiedergabe einstellen

Sie können die Lautstärke am Basisgerät während einer Wiedergabe in 5 Stufen einstellen.

 / 	Lautstärke erhöhen / verringern
---	---------------------------------

Sie können die Lautstärke am Mobilteil während einer Wiedergabe in 5 Stufen einstellen.



 / 	Lautstärke erhöhen / verringern
---	---------------------------------

Eine Nachricht löschen

Während der Wiedergabe einer Nachricht:

BS: 	Nachricht löschen
---	-------------------

oder

MT:  	Menü öffnen
---	-------------

MT:  /   	
---	--

	Nachricht löschen
---	-------------------

oder

MT: 	Nachricht löschen
---	-------------------







Alle Nachrichten löschen

Es werden alle alten Nachrichten gelöscht.



Gelöschte Nachrichten können nicht wiederhergestellt werden!



  oder  /  	
--	--

  oder   ,  	
--	--

Mithören



Sie können eingehende Anrufe am Basisgerät über den Lautsprecher mithören, ohne den Anruf anzunehmen. Dazu müssen Sie das Mithören im Menü aktivieren  Menü Seite 14 (Mithören).



Um die Lautstärke während des Mithörens zu verändern drücken Sie die Tasten  und .

Anruf übernehmen

Wenn der Anrufbeantworter bereits einen Anruf entgegengenommen hat, können Sie diesen übernehmen. Die Aufzeichnung der Nachricht wird in diesem Fall abgebrochen.

 oder  oder 	Anruf übernehmen
---	------------------

Verzögerung der Anrufannahme

Legen Sie über das Menü fest, wie oft das Telefon klingeln soll, bevor ein Ansagetext zu hören ist. Sie können zwischen 2, 4, 6 oder 8 Tonrufen wählen  Menü Seite 14 (Rufannahme).



Werkseitig ist der Anrufbeantworter auf 4 Tonrufe eingestellt.

Zusätzlich können Sie die Einstellung **Gebührsparer** für die gebührenfreie Vor-/Fernabfrage verwenden. Mit dieser Vor-/Fernabfrage können Sie gebührenfrei feststellen, ob sich neue Nachrichten auf Ihrem Anrufbeantworter befinden. Befinden sich neue Nachrichten auf Ihrem Anrufbeantworter, wird Ihr Anruf spätestens nach 2 Tonrufen angenommen. Befinden sich keine neuen Nachrichten auf Ihrem Anrufbeantworter, wird Ihr Anruf erst nach 6 Tonrufen angenommen. Legen Sie vor dem 6. Tonruf auf. So fallen keine Gebühren an.

Weitere Informationen über die Fernabfrage  Seite 38.

Maximale Aufnahmezeit je Nachricht





Es stehen 4 Aufnahmezeiten zur Verfügung  Menü Seite 15 (Nachr.länge)

Memo aufzeichnen

Ein Memo ist eine Mitteilung, die Sie für eine andere Person hinterlassen können und die wie eine eingegangene Nachricht abgehört werden kann. Ein Memo darf maximal 3 Minuten lang sein und wird am Mobilteil aufgesprochen.



Memos können auch bei ausgeschaltetem Anrufbeantworter aufgezeichnet werden.

 oder   /  **AB**,

 oder 

Untermenü auswählen

 oder   /  **Memo aufn.**,

 oder 

Aufzeichnung beginnen



Memo aufsprechen

 oder 



Aufzeichnung beenden und speichern

Memoaufnahme abbrechen

BS: 

Aufzeichnung abbrechen und zurück zum Untermenü

oder

MT:  oder 

Aufzeichnung abbrechen und zurück zum Untermenü

Anrufbeantworter

Fernabfrage

Sie können Ihren Anrufbeantworter anrufen, um ihn einzuschalten oder um Nachrichten abzuhören und weitere Funktionen durchzuführen. Voraussetzung dafür ist ein Telefon mit Tonwahlfunktion.

PIN-Code für die Fernabfrage

Die Fernabf.-PIN ist werkseitig auf "1234" eingestellt. Es ist empfehlenswert die Fernabf.-PIN zu ändern, damit keine unbefugten Personen Zugriff auf Ihren Anrufbeantworter haben.

PIN-Code für die Fernabfrage ändern ☞ Menü Seite 15.



Wenn Sie den PIN-Code für die Fernabfrage geändert und anschließend vergessen haben, können Sie den PIN-Code für die Fernabfrage im Menü nachschauen ☞ Menü Seite 19 (Fernabf.-PIN).

Fernabfrage starten

Das Telefon, das Sie für die Fernabfrage nutzen, muss auf Tonwahl-Verfahren eingestellt sein.



Von einem externen Telefonanschluss die eigene Rufnummer wählen.



Ist der Anrufbeantworter eingeschaltet, wird der Ansagetext nach der eingestellten Anzahl Tonrufe abgespielt.

Ist der Anrufbeantworter nicht eingeschaltet, schaltet sich das Telefon nach dem 10. Tonruf automatisch ein und es ertönt ein langer Signalton.



Fernabfrage einleiten.
Danach ertönt ein langer Signalton.



Ist der Anrufbeantworter eingeschaltet, müssen Sie die Fernabfrage einleiten, solange der Ansagetext abgespielt wird. Deshalb ist es wichtig, dass der Ansagetext ausreichend lang ist.



4-stelligen PIN-Code für die Fernabfrage eingeben.
Danach ertönt ein langer Signalton.

Jetzt haben Sie die Möglichkeit, weitere Funktionen durchzuführen

☞ Tabelle Tastenfunktionen der Fernabfrage auf Seite 39.



Taste drücken, um die gewünschte Funktion auszuführen. Danach ertönt ein langer Signalton.



Sie können mehrere Funktionen hintereinander durchführen.

Fernabfrage beenden



Fernabfrage beenden

Tastenfunktionen der Fernabfrage

Die folgende Tabelle verschafft Ihnen eine Übersicht über die verfügbaren Funktionen und welche Taste gedrückt werden muss, um die jeweilige Funktion auszuführen.

Taste	Wenn <u>keine</u> Nachrichten abgespielt werden	Wenn Nachrichten abgespielt werden
0		Nachricht löschen
1		Nachricht wiederholen
2	Nachricht wiedergeben, Wiedergabe fortsetzen	Wiedergabe stoppen (Pause)
3		Nächste Nachricht abhören
4	Anrufbeantworter ein-/ausschalten	
5	Memo aufzeichnen ¹	
*		Wiedergabe beenden

Anrufbeantworter via Fernabfrage einschalten



Von einem externen Telefonanschluss die eigene Rufnummer wählen. Nach dem 10. Tonruf schaltet das Telefon ein und es ertönt ein langer Signalton.



Fernabfrage einleiten.
Danach ertönt ein langer Signalton.



4-stelligen PIN-Code für die Fernabfrage eingeben.
Danach ertönt ein langer Signalton.



Anrufbeantworter einschalten.
Danach ertönt ein langer Signalton.
Der Ansagetext wird wiedergegeben.



Auflegen / Verbindung beenden

¹ Beenden Sie die Aufzeichnung eines Memos durch Beenden der Fernabfrage.

Erweitern des Telefonsystems

8 Erweitern des Telefonsystems

Über den international genormten **GAP**¹-Standard ist die Kompatibilität von Mobilteilen und Telefonen (Basisstationen) unterschiedlicher Hersteller geregelt. So ist es möglich, SWITEL-Geräte und Geräte anderer Hersteller zusammen in ein Telefonsystem zu integrieren. Es ist jedoch möglich, dass einige Funktionen nicht zur Verfügung stehen.



Mehrere Mobilteile

Sie können insgesamt 6 Mobilteile an dem Basisgerät anmelden.

Anmelden von Mobilteilen

Mobilteile werden über das Menü angemeldet → Menü Seiten 19 und 20.



Am Basisgerät:

 / , **Basis-Einst.**,  Menü öffnen

 / , **Anmelden**, 

Bestätigen?, , **Suche...** Menü öffnen

Am anzumeldenden Mobilteil:

 / , **Basis-Einst.**,  Menü öffnen

 / , **Anmelden**,

, **Basis x** Menü öffnen

 / , **Basis x**,  gewünschte Basis auswählen

PIN?, ,  PIN² eingeben und bestätigen



Durch Drücken von Taste  können Sie falsch eingegebene Ziffern löschen.

Das Mobilteil sucht das Basisgerät. Dieser Vorgang kann bis zu 2 Minuten dauern.

Nach dem Anmelden wird dem Mobilteil eine interne Rufnummer zugeteilt. Diese interne Rufnummer wird im Display angezeigt.



Um Mobilteile anderer Hersteller anzumelden, lesen Sie bitte deren Bedienungsanleitungen.

¹ **GAP**: **Generic Access Profile** = Standard für das Zusammenwirken von Mobilteilen und Basisstationen unterschiedlicher Hersteller.

² Die PIN ist werkseitig auf "0000" eingestellt.

Erweitern des Telefonsystems

Abmelden von Mobilteilen



Sie können ein Mobilteil nur vom Basisgerät oder von einem weiteren am Basisgerät angemeldeten Mobilteil abmelden. Ein Mobilteil kann sich nicht selber abmelden.

Mobilteile werden über das Menü abgemeldet → Menü Seiten 19 und 20.

Am Basisgerät:

/ / **Basis-Einst.** Menü öffnen

/ **Erw. Einst.** Menü öffnen

/ **Abmelden** Menü öffnen

Mobilteil 0x /

Bitte warten Mobilteil auswählen und Abmeldevorgang starten

Mehrere Basisstationen¹/Basisgeräte²

Sie können die Reichweite Ihres Mobilteils vergrößern, wenn Sie es an mehrere Telefone (Basisstationen¹/Basisgeräte²) anmelden. Es kann gleichzeitig an 4 verschiedenen Telefonen (Basisstationen¹/Basisgeräten²) angemeldet sein. Jedes Telefon (jede(s) Basisstation¹/Basisgerät²) benötigt eine eigene Telefonanschlussdose. Es können Anschlüsse mit derselben und auch mit unterschiedlichen Rufnummern sein.



Laufende Gespräche können nicht von einem zum anderen Telefon (von einer zur anderen Basisstation bzw. von einem zum anderen Basisgerät) übertragen werden.



¹ Die Basis des DC 58x wird als Basisstation bezeichnet.

² Die Basis des DCT 587x wird als Basisgerät bezeichnet.



Nebenstellenanlagen / Zusatzdienste

9 Nebenstellenanlagen / Zusatzdienste

R-Taste und Zusatzdienste

Ihr Telefon unterstützt Zusatzdienste Ihres Netzbetreibers, wie z. B. Makeln, Anklopfen und Konferenz. Über die Taste  können Sie diese Zusatzdienste nutzen. Bitte fragen Sie Ihren Netzbetreiber, welche Flash-Zeit Sie zur Nutzung von Zusatzdiensten einstellen müssen. Zur Freischaltung von Zusatzdiensten wenden Sie sich bitte an Ihren Netzbetreiber. Die Flash-Zeit stellen Sie über das Menü ein  Seite 19.

R-Taste an Nebenstellenanlagen

Ist Ihr Telefon an einer Nebenstellenanlage angeschlossen, können Sie über die Taste  Funktionen, wie z. B. Anrufe weiterleiten und automatischen Rückruf, nutzen. Lesen Sie bitte in der Bedienungsanleitung Ihrer Nebenstellenanlage, welche Flash-Zeit Sie zur Nutzung dieser Funktionen einstellen müssen. Ob Ihr Telefon an Ihrer Nebenstellenanlage einwandfrei funktioniert, erfahren Sie bei dem Händler, bei dem die Anlage gekauft wurde. Die Flash-Zeit stellen Sie über das Menü ein  Seite 19.

Zugangscode (Amtskennzahl)

Bei Nebenstellenanlagen ist es erforderlich, eine Amtskennzahl vorzuwählen, um ein Freizeichen zu bekommen. Oftmals ist die Amtskennzahl eine "0" oder eine "9". Tippen Sie zuerst diese Amtskennziffer ein und warten Sie das Freizeichen ab. Jetzt können Sie die eigentliche Rufnummer eingeben.



Wenn Sie die Direktwahlfunktionen Ihres Telefons auch an einer Nebenstellenanlage nutzen möchten, beachten Sie bitte, dass Sie beim Programmieren der Direktwahltasten die Amtskennziffer der eigentlichen Rufnummer voranstellen. Zwischen Amtskennziffer und Rufnummer können Sie gegebenenfalls auch noch eine Wahlpause einprogrammieren  Abschnitt "Wahlpause".

Wahlpause

Bei Nebenstellenanlagen ist es erforderlich, eine Amtskennzahl vorzuwählen, um ein Freizeichen zu bekommen. Bei wenigen älteren Nebenstellenanlagen dauert es einige Zeit, bis das Freizeichen zu hören ist. Für diese Nebenstellenanlagen kann nach der Amtskennzahl eine Wahlpause eingefügt werden, um direkt weiterwählen zu können, ohne das Freizeichen abzuwarten. Die Wahlpause fügen Sie durch Drücken und 3 Sek. Halten der Taste  ein.

Nach der Amtskennzahl erfolgt die Wahl der eigentlichen Rufnummer nach einer bestimmten Zeit.



Die Wahlpause kann auch bei der Eingabe von Rufnummern im Telefonbuch gespeichert werden.

Nebenstellenanlagen / Zusatzdienste

Rufnummernanzeige (CLIP¹)



Die Rufnummernanzeige ist ein Zusatzdienst Ihres Netzbetreibers. Fragen Sie Ihren Netzbetreiber nach weiteren Informationen.

Wenn diese Funktion an Ihrer Telefonleitung zur Verfügung steht, wird Ihnen bereits die Rufnummer des Anrufers angezeigt, wenn das Telefon klingelt. Hat der Anrufer das Übertragen seiner Rufnummer unterdrückt, wird eine entsprechende Meldung angezeigt. Die Rufnummer kann nicht angezeigt und somit auch nicht in der Anrufliste gespeichert werden.

Anrufbeantworter im Telefonnetz

Der Anrufbeantworter im Telefonnetz ist ein Zusatzdienst vieler Netzbetreiber. Wenn Ihr Netzbetreiber einen Anrufbeantworter im Telefonnetz für Sie bereitstellt, werden Sie mit einem Symbol über neue Nachrichten informiert (**VMWI**²). Über diese Funktion können Sie nur dann verfügen, wenn Ihr Netzbetreiber diesen Zusatzdienst anbietet. Bitte fragen Sie Ihren Netzbetreiber nach weiteren Informationen.

¹ **CLIP**: Calling Line Identification Presentation = Anzeige der Rufnummer eines Anrufers.

² **VMWI**: Visual Message Waiting Indication = Optische Anzeige neuer Nachrichten.

Technische Eigenschaften

10 Technische Eigenschaften

Merkmal	Wert
Standard	DECT¹-GAP²
Stromversorgung (Basisgerät)	Eingang: 100-240 V, 50-60 Hz Ausgang: 6 V, 500 mA
Stromversorgung (Ladestation)	Eingang: 100-240 V, 50-60 Hz Ausgang: 6 V, 150 mA
Aufladbare Akkus	2 x 1.2 V 500 mAh NiMH, Größe: AAA
Max. Sendeleistung	24 dBm
Frequenzbereich	1880-1900 MHz
Reichweite Mobilteil	Außen: ca. 300 m Innen: ca. 50 m
Stand-by-Zeit Mobilteil	Bis zu 110 h
Max. Gesprächsdauer Mobilteil	Bis zu 11 h
Max. Hörerlautstärke	30 dB
Wahlverfahren	Tonwahl-Verfahren (MFV) Impulswahl-Verfahren (IWW)
Flash-Zeit	Kurz, Mittel, Lang
Menüsprachen	Deutsch, Französisch, Italienisch, Englisch, Spanisch, Portugiesisch, Niederländisch, Polnisch, Türkisch
PIN (Werkseinstellung)	0000
Anzahl Ruftöne	12 (polyphone)
Max. Anzahl Einträge Telefonbuch	50
Max. Anzahl Einträge Anrufliste	40
Max. Anzahl Einträge Wahlwiederholung	5
Max. Anzahl Nachrichten Anrufbeantworter	57
Max. Aufzeichnungsdauer Anrufbeantworter	15 min (inklusive Ansagetexte)
Sprachen Standardansagetexte	Deutsch, Französisch, Italienisch, Englisch
PIN-Code für Fernabfrage (Werkseinstellung)	1234

¹ **DECT**: Digital Enhanced Cordless Telecommunication = Standard für kabellose Telefone.

² **GAP**: Generic Access Profile = Standard für das Zusammenwirken von Mobilteilen und Basisstationen unterschiedlicher Hersteller.

Konformitätserklärung

Dieses Gerät erfüllt die Anforderungen der EU-Richtlinie:

1999/5/EG Richtlinie über Funkanlagen und Telekommunikationsendeinrichtungen und die gegenseitige Anerkennung ihrer Konformität. Die Konformität mit der o. a. Richtlinie wird durch das CE-Zeichen auf dem Gerät bestätigt.



Service-Hotline

Haben Sie Probleme mit Ihrem Telefon, kontrollieren Sie zuerst die folgenden Hinweise. Bei technischen Problemen können Sie sich an unsere Service-Hotline unter Tel. 0900 00 1675 innerhalb der Schweiz (Kosten Swisscom bei Drucklegung: CHF 2.60/min) wenden. Bei Garantieansprüchen wenden Sie sich an Ihren Fachhändler. Die Garantiezeit beträgt 2 Jahre.

11 Probleme

Fragen	Antworten
Kein Telefongespräch möglich	<ul style="list-style-type: none">- Das Telefon bzw. Basisgerät ist nicht korrekt angeschlossen oder gestört. Verwenden Sie nur das mitgelieferte Telefonanschlusskabel.- Das Netzteil ist nicht eingesteckt oder es liegt ein totaler Stromausfall vor.- Testen Sie mit einem anderen Telefon, ob Ihr Telefonanschluss in Ordnung ist.- Falscher Aufstellungsort des Basisgeräts.- Die aufladbaren Akkus sind leer oder defekt.- Sie haben sich mit einem Mobilteil zu weit vom Basisgerät entfernt. Zur Vergrößerung der Reichweite können Sie ein Mobilteil auch an mehrere Basisgeräte/Basisstationen anmelden ☞ Seite 41.- Wahlverfahren falsch eingestellt ☞ Seite 19- Wenn mehrere Mobilteile angemeldet sind: An einem anderen Mobilteil wird ein Gespräch geführt.- Bei internen Telefongesprächen: Das angerufene Mobilteil ist außerhalb der Reichweite des Basisgeräts.- Die Tastensperre ist aktiviert.- Das Mobilteil ist nicht eingeschaltet.
Keine Verbindung zum Basisgerät möglich	<ul style="list-style-type: none">- Prüfen Sie, ob Sie ein Mobilteil am Basisgerät angemeldet ist bzw. ob das Mobilteil mit der richtigen PIN am Basisgerät angemeldet wurde ☞ Seite 19.
Verbindung abgehackt, fällt aus	<ul style="list-style-type: none">- Sie haben sich zu weit vom Basisgerät entfernt.- Falscher Aufstellungsort des Basisgeräts.
Während eines Telefongesprächs ertönen Signaltöne	<ul style="list-style-type: none">- Sie haben sich zu weit von dem Basisgerät entfernt.- Die aufladbaren Akkus sind fast leer.

Probleme

Fragen	Antworten
Das System reagiert nicht mehr	<ul style="list-style-type: none">- Setzen Sie alle Funktionen auf Werkseinstellungen zurück ☞ Seite 19.- Ziehen Sie kurzzeitig das Netzteil aus der Steckdose.
Die Akkus sind in kürzester Zeit leer	<ul style="list-style-type: none">- Die Akkus sind leer oder defekt.- Stellen Sie das Mobilteil richtig auf die Basis-/Ladestation. Reinigen Sie die Kontaktflächen am Mobilteil und an der Basis-/Ladestation mit einem weichen trockenen Tuch.- Stellen Sie das Mobilteil für 8 Stunden in die Basis-/Ladestation.
Die Akkus lassen sich nicht mehr aufladen	<ul style="list-style-type: none">- Die Akkus sind defekt.
Die Rufnummernanzeige (CLIP) funktioniert nicht	<ul style="list-style-type: none">- Die Rufnummernanzeige ist ein Zusatzdienst Ihres Netzbetreibers. Bitte fragen Sie Ihren Netzbetreiber nach weiteren Informationen.- Der Anrufer hat das Übertragen seiner Rufnummer unterdrückt.
Der Anrufbeantworter nimmt keine Nachrichten auf	<ul style="list-style-type: none">- Prüfen Sie, ob der Anrufbeantworter eingeschaltet ist.- Prüfen Sie, ob der Speicher des Anrufbeantworters voll ist. Löschen Sie ggf. Nachrichten.
Der Anrufbeantworter lässt sich nicht in den Ansage- und Aufnahme-Modus schalten	<ul style="list-style-type: none">- Prüfen Sie, ob der Speicher des Anrufbeantworters voll ist. Der Anrufbeantworter schaltet dann automatisch in den Nur-Ansage-Modus, bei dem keine Nachrichten hinterlassen werden können. Löschen Sie ggf. Nachrichten.
Sie können keine Fernabfrage durchführen	<ul style="list-style-type: none">- Das Telefon, das Sie für die Fernabfrage nutzen, muss auf Tonwahl-Verfahren eingestellt sein.- Prüfen Sie, ob der Anrufbeantworter eingeschaltet ist.- Prüfen Sie, ob Sie den richtigen PIN-Code für die Fernabfrage benutzen ☞ Seite 38. Haben Sie den PIN-Code für die Fernabfrage vergessen, können Sie den PIN-Code für die Fernabfrage im Menü nachschauen oder das Telefon und den PIN-Code für die Fernabfrage in Werkseinstellung zurücksetzen.- Drücken Sie die Tasten langsam und ausreichend fest.- Starten Sie die Fernabfrage noch während der Ansagetext wiedergegeben wird. Ist die Dauer der Wiedergabe des Ansagetextes zu kurz, nehmen Sie einen längeren Ansagetext auf.

12 Pflegehinweise / Garantie

Pflegehinweise

- Reinigen Sie die Gehäuseoberflächen mit einem weichen und fusselfreien Tuch.
- Verwenden Sie keine Reinigungs- oder Lösungsmittel.

Außer einer gelegentlichen Gehäusereinigung ist keine weitere Pflege erforderlich.

Garantie

SWITEL - Geräte werden nach den modernsten Produktionsverfahren hergestellt und geprüft. Ausgesuchte Materialien und hoch entwickelte Technologien sorgen für einwandfreie Funktion und lange Lebensdauer. Ein Garantiefall liegt nicht vor, wenn die Ursache einer Fehlfunktion des Geräts bei dem Telefonnetzbetreiber oder einer eventuell zwischengeschalteten Nebenstellenanlage liegt. Die Garantie gilt nicht für die in den Produkten verwendeten Batterien, Akkus oder Akkupacks. Die Garantiezeit beträgt 24 Monate, gerechnet vom Tage des Kaufs.

Innerhalb der Garantiezeit werden alle Mängel, die auf Material- oder Herstellungsfehler zurückzuführen sind, kostenlos beseitigt. Der Garantieanspruch erlischt bei Eingriffen durch den Käufer oder durch Dritte. Schäden, die durch unsachgemäße Behandlung oder Bedienung, natürliche Abnutzung, durch falsches Aufstellen oder Aufbewahren, durch unsachgemäßen Anschluss oder Installation sowie durch höhere Gewalt oder sonstige äußere Einflüsse entstehen, fallen nicht unter die Garantieleistung. Wir behalten uns vor, bei Reklamationen die defekten Teile auszubessern, zu ersetzen oder das Gerät auszutauschen. Ausgetauschte Teile oder ausgetauschte Geräte gehen in unser Eigentum über. Schadenersatzansprüche sind ausgeschlossen, soweit sie nicht auf Vorsatz oder grober Fahrlässigkeit des Herstellers beruhen.

Sollte Ihr Gerät dennoch einen Defekt innerhalb der Garantiezeit aufweisen, wenden Sie sich bitte unter Vorlage Ihrer Kaufquittung ausschließlich an das Geschäft, in dem Sie Ihr SWITEL - Gerät gekauft haben. Alle Gewährleistungsansprüche nach diesen Bestimmungen sind ausschließlich gegenüber Ihrem Fachhändler geltend zu machen. Nach Ablauf von zwei Jahren nach Kauf und Übergabe unserer Produkte können Gewährleistungsrechte nicht mehr geltend gemacht werden.

13 Stichwortverzeichnis

A

Abmelden, 41
Abwärts-Taste, 9
Akkuladezustand, 8
Akkus, 5, 44
Akkus aufladen, 8
Akkus in Mobilteil einsetzen, 8
Alle Einträge löschen, 27
Alle Nachrichten löschen, 36
Alle Rufnummern löschen, 29
Amtskennzahl, 42
Anmelden, 40
Anruf annehmen, 21
Anruf-LED, 9, 10
Anrufbeantworter, 33
Anrufbeantworter im Telefonnetz, 43
Anrufbeantworter
 via Fernabfrage einschalten, 39
Anrufe in Abwesenheit, 29
Anrufen, 22
Anruferliste, 9
Anrufliste, 10, 29
Anrufsperrung, 32
Anrufübernahme, 36
Ansagetext, 34
Ansagetext anhören, 34
Ansagetext aufzeichnen, 34
Antwortmodus wählen, 33
Anzahl Einträge Anrufliste, 44
Anzahl Einträge Telefonbuch, 44
Anzahl Einträge Wahlwiederholung, 44
Anzahl Nachrichten Anrufbeantworter, 44
Auflegen-/Ein-/Aus-Taste, 10
Aufnahmezeit je Nachricht, 37
Aufstellungsort, 4
Aufwärts-Taste, 9
Aufzeichnungsdauer Anrufbeantworter, 44
Ausschalten, 33
Automatische Rufannahme, 31

B

Babyruf, 32
Basisgerät, 9
Basisgerät anschließen, 7
Basisgeräte, 41
Basisstationen, 41
Bedienelemente, 9
Bedienung, 21
Bereitschaftsmodus, 12
Besondere Funktionen, 31
Bestimmungsgemäße Verwendung, 4

C

CLIP, 32, 43

D

Darstellungsweisen
 in der Bedienungsanleitung, 12
Datum einstellen, 8
DECT, 44
Direktwahl, 22
Direktwahl-Tasten, 9, 10
Direktwahl-Tasten programmieren, 27
Display, 9, 11
Display-Kontrast, 30
Display-Sprache einstellen, 8
Display-Symbole, 11

E

ECO-Mode, 8
Ein-/Aus-Taste Anrufbeantworter, 9
Einen Eintrag löschen, 27
Eingegangene Anrufe zurückrufen, 22, 29
Einschalten, 33
Einzelne Rufnummer löschen, 29
Entsorgung, 5
Equalizer, 30
Erweitern des Telefonsystems, 40
Externe Gespräche intern weiterleiten, 23
Externe Gespräche während eines internen
 Telefonats annehmen, 23

F

Fernabfrage, 38
Fernabfrage beenden, 38
Fernabfrage starten, 38
Flash-Zeit, 42, 44
Freisprech-Taste, 9
Freisprechen, 10, 25

G

GAP, 44
Garantie, 47
Gebührensparer, 37
Gespräch beenden, 21
Gespräch-Taste, 10
Gesprächsdauer, 24, 44
Gesprächsweiterleitung, 23

H

Hauptmenü, 14
Hörer, 9
Hörerlautstärke einstellen, 24
Hörerlautstärke maximale, 44
Hörgerätekompatibel, 5
Hörmuschel, 10

I

Inbetriebnahme, 6
INT-Taste, 9
Intern telefonieren, 22
Interne Gespräche führen, 23

K

Konferenzgespräche, 23
Konformitätserklärung, 45

L

Ladestation anschließen, 7
Lautstärke für Nachrichtenwiedergabe einstellen, 36
LC-Display, 10

M

Makeln, 23
Maximale Aufnahmezeit, 33
Medizinische Geräte, 5
Mehrere Basisstationen, 41
Mehrere Mobilteile, 40
Memo aufzeichnen, 37
Memoaufnahme abbrechen, 37
Menü-/OK-/Stumm-Taste, 10
Menüführung, 12
Menüsprachen, 44
Menüstruktur, 14
Mikrofon am Basisgerät, 9
Mikrofon am Mobilteil, 10
Mikrofon stummschalten, 25
Mithören, 36
Mobilteil, 10
Mobilteil abmelden, 41
Mobilteil anmelden, 40
Mobilteilname, 30

N

Nachrichten abhören, 35
Nachrichten am Basisgerät wiedergeben, 35
Nachrichten am Mobilteil wiedergeben, 35
Nachrichten löschen, 36
Namen eingeben, 25
Nebenstellenanlagen, 8, 42
Netzteil, 4
Notruf, 32
Numerische Tasten, 9, 10

O

OK-/Menü-Taste, 9
Optionen während der Wiedergabe, 35
optische Rufanzeige, 10
optische Rufanzeige (Anruf-LED), 9, 10

Stichwortverzeichnis

P

- Paging, 31
- Pfeil-Taste rauf, 10
- Pfeil-Taste runter, 10
- Pflegehinweise, 47
- PIN, 40, 44
- PIN ändern, 31
- PIN-Code für die Fernabfrage, 38
- PIN-Code für Fernabfrage (Werkseinstellung), 44
- Probleme, 45

R

- R-Taste, 9, 10, 42
- Raute-Taste, 9
- Raute-Taste / Rufton aus / Wahlpause, 10
- Reichweite, 44
- Reinigen, 47
- Rückruf, 22
- Rücksprache, 23
- Rückwärts-Taste, 9
- Rufnummer aus der Wahlwiederholungsliste im Telefonbuch abspeichern, 28
- Rufnummer aus der Wahlwiederholungsliste löschen, 28
- Rufnummer aus der Wahlwiederholungsliste wählen, 28
- Rufnummern aus der Anrufliste anzeigen, 29
- Rufnummern aus der Anrufliste löschen, 29
- Rufnummernanzeige, 43
- Rufnummernanzeige (CLIP), 32
- Rufton aus- und einschalten, 24
- Rufton einstellen, 30
- Ruftöne, 44
- Ruftonlautstärke des Basisgeräts einstellen, 24
- Ruftonlautstärke des Mobilteils einstellen, 24

S

- Service-Hotline, 45
- Sicherheitshinweise, 4
- Speichern im Telefonbuch, 28, 29
- Sprache der Ansagetexte, 34
- Sprachen Standardansagetexte, 44
- Stand-by-Modus, 12
- Stand-by-Zeit, 44
- Stern-Taste, 9, 10
- Strahlungsreduzierung, 8
- Stromausfall, 4
- Stromversorgung, 44
- Stummschaltung, 25
- Suchen des Mobilteils, 31
- Symbole, 11

T

- Tastenfunktionen der Fernabfrage, 39
- Tastensperre, 21, 31
- Tastentöne, 30
- Telefonbuch, 9, 10, 22, 25
- Telefonbucheinträge, 13
- Telefonbucheinträge ändern, 26
- Telefonbucheinträge erstellen, 26
- Telefonbucheinträge löschen, 27
- Telefonbuchkapazität prüfen, 27
- Telefonieren, 21
- Texteingabe, 25
- Ton- und Anzeigeeinstellungen, 30

U

- Uhrzeit einstellen, 8
- Untermenüs auswählen, 13

V

- Verpackungsinhalt, 6
- VMWI, 43
- Vorwahlnummer, 31
- Vorwärts-Taste, 9

W

- Wählen, 22
- Wahlpause, 42
- Wahlverfahren, 32, 44
- Wahlwiederholung, 10, 22
- Wahlwiederholung-Taste, 9
- Wahlwiederholungsliste, 28
- Wahlwiederholungsliste löschen, 28
- Warnton Akkukapazität, 30
- Warnton Reichweite, 30
- Wecker, 31
- Wecker stellen, 32
- Weckruf vorzeitig beenden, 32
- Weiterleitung, 23
- Wiedergabe-/Stopp-Taste, 9

Z

- Zeit- und Datumsformat, 30
- Zugangscode, 42
- Zurück-Taste, 9
- Zurücksetzen, 31
- Zusatzdienste, 42

1	Consignes de sécurité	54
2	Mise en service	56
3	Éléments de manipulation	59
4	Introduction	62
5	Structure de menu	64
6	Utilisation	71
7	Répondeur	83
8	Élargir le système téléphonique	90
9	Installations PABX / Services confort	92
10	Caractéristiques techniques	94
11	Problèmes	95
12	Remarques d'entretien / Garantie	97
13	Index	98

Consignes de sécurité

1 Consignes de sécurité

Lisez très attentivement ce mode d'emploi.

Utilisation conforme aux prescriptions

Ce téléphone avec combiné convient pour téléphoner à l'intérieur d'un réseau téléphonique. Toute autre utilisation est considérée comme non conforme aux prescriptions. Des modifications ou transformations effectuées de façon arbitraire sont interdites. N'ouvrez en aucun cas l'appareil et n'essayez pas de le réparer vous-même.

Panne de courant

Dans le cas d'une panne de courant, il n'est pas possible de téléphoner avec cet appareil. En cas d'urgence, prévoyez un téléphone avec fil fonctionnant sans alimentation externe en courant.

Lieu d'installation

L'endroit où vous le déposez a une influence décisive sur son bon fonctionnement.

Évitez les nuisances causées par la fumée, la poussière, les vibrations, les produits chimiques, l'humidité, la grande chaleur ou un ensoleillement direct. Ne vous servez pas du téléphone dans des endroits exposés aux explosions.

Ne le placez pas à proximité immédiate d'appareils électroniques tels que téléviseurs, radios, microondes, réfrigérateurs, etc., ceci pourrait provoquer une interaction entre votre téléphone et les appareils. Ne le placez pas non plus à proximité d'un autre téléphone. Veillez à ce que des objets métalliques de grande taille tels que réfrigérateur ou miroir ne se trouvent pas entre la base et le combiné. Les murs peuvent également exercer une influence sur leur connexion.

Placez le téléphone à proximité d'une prise de courant appropriée et du raccordement téléphonique. Posez le câble de telle sorte que personne ne puisse trébucher à cause de lui.



Attention : ne pas lui mettre de rallonge !

Posez le téléphone sur une surface plane sur laquelle il ne pourra pas glisser. Les pieds du téléphone ne laissent généralement pas de traces sur la surface où il est posé. Cependant, étant donné le nombre de laques et de surfaces utilisées, il se peut qu'ils en laissent.

Plus la base est haut placée (même en intérieur), meilleure est la portée.

Bloc d'alimentation



Attention : N'utilisez que le bloc d'alimentation fourni avec l'appareil, d'autres pouvant endommager le téléphone. Veillez à ce qu'aucun meuble ou autre objet ne bloque l'accès au bloc d'alimentation.

Consignes de sécurité

Accus rechargeables



Attention : Ne jetez jamais les accus dans le feu. N'utilisez que des accus du même type ! Veillez à ce que la polarité soit correcte ! Risque d'explosion lors de la charge si celle-ci est incorrecte.



Attention : N'utilisez que les accus rechargeables prescrits. N'utilisez pas de piles. Risque d'explosion !

Appareils médicaux



Attention : N'utilisez pas le téléphone à proximité d'appareils médicaux. Il n'est pas entièrement exclu qu'il pourrait avoir une influence sur ceux-ci.

Compatibilité avec les prothèses auditives

Ce téléphone est compatible avec la plupart des aides auditives en vente sur le marché. Cependant, un fonctionnement irréprochable ne peut être garanti pour chacune d'entre elles.

DECT¹ peuvent causer un bourdonnement désagréable dans les aides auditives.

Traitement des appareils hors d'usage

Si vous ne voulez plus servir de votre appareil, veuillez l'apporter au centre de collecte de l'organisme de traitement des déchets de votre commune (par ex. centre de recyclage). D'après la loi relative aux appareils électriques et électroniques, les propriétaires d'**appareils électriques et électroniques** hors d'usage sont tenus de les déposer dans un collecteur séparé. L'icône ci-contre signifie que vous ne devez en aucun cas jeter votre appareil dans les ordures ménagères !



Risque pour l'homme et l'environnement lié aux piles et accus !

Ne jamais ouvrir, endommager, avaler les piles et accus ou faire pénétrer leur contenu dans l'environnement. Ils peuvent contenir des métaux lourds toxiques et nuisibles pour celui-ci. Vous êtes tenus par la loi d'apporter vos piles et accus à un revendeur de piles ainsi qu'à un centre de collecte responsables de leur traitement qui mettent des conteneurs adéquats à disposition. Ce geste écoresponsable est gratuit. L'icône ci-contre signifie que vous ne devez en aucun cas jeter les piles et accus dans les ordures ménagères, mais que vous devez les apporter à un centre de collecte.



Éliminez les **fournitures d'emballage** conformément au règlement local.

¹ DECT : Digital Enhanced Cordless Telecommunication = Norme de téléphonie numérique sans fil optimisée.

Mise en service

2 Mise en service

Consignes de sécurité



Attention : Avant de mettre votre téléphone en service, lisez impérativement les consignes de sécurité mentionnées au chapitre 1.

Vérifier le contenu du coffret

Son contenu :

Contenu	Modèle DCT 587X			
	DCT 5871	DCT 5872 ¹	DCT 5873 ¹	DCT 5874 ¹
Appareil de base	1	1	1	1
Bloc secteur	1	1	1	1
Combiné	1	1	1	1
Cordon spiralé du combiné	1	1	1	1
Câble téléphonique	1	1	1	1
Station d'accueil avec bloc secteur	1	2	3	4
Combiné	1	2	3	4
Accus (AAA 1.2 V NiMH)	2	4	6	8
Guide de l'utilisateur	1	1	1	1

¹ À l'adresse www.switel.com, vous apprendrez si ce téléphone / kit téléphonique est déjà disponible à la vente.

Mettre l'appareil en service

Raccorder l'appareil de base

Raccordez l'appareil de base comme représenté sur le croquis. Pour des raisons de sécurité, n'utilisez que le bloc secteur fourni avec l'appareil.

Tenez absolument compte des informations contenues dans le passage «Lieu d'installation»
☞ page 54.

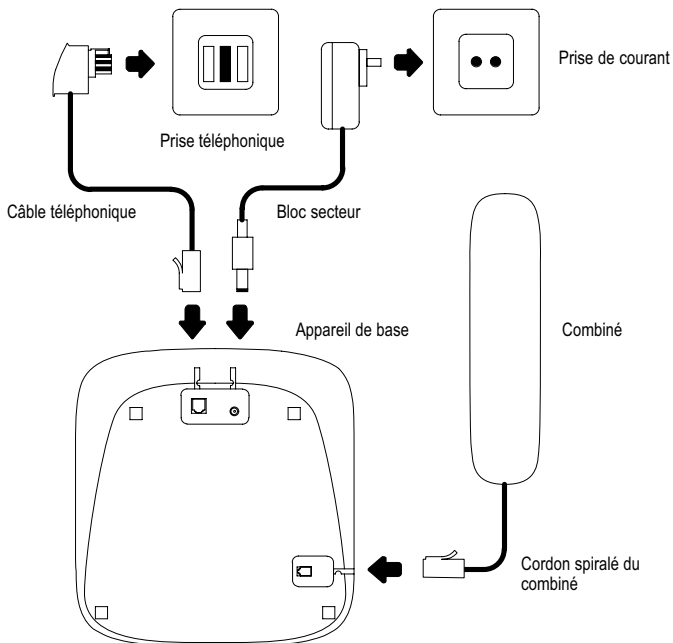

Utilisez pour l'appareil de base le bloc d'alimentation présentant les données de sortie 100-240 VCA 6 VCC 500 mA.

Raccorder la station d'accueil

Raccordez la station d'accueil à une prise de courant.

Mise en service

Insérer les accus dans le combiné

Le compartiment accus se trouve au dos du combiné. Ouvrez celui-ci et insérez 2 accus de type AAA NiMH, 1.2 V 500 mAh. Veillez à ce que la polarité soit correcte ! Refermez le compartiment.

Recharger les accus



Lors de la première mise en service, laissez le combiné pendant **au moins 8 heures** dans sa station d'accueil.

Si vous avez placé correctement le combiné dans celle-ci, vous entendez un bip de confirmation. Le combiné chauffe pendant la charge. Ceci est normal et sans danger. Utilisez uniquement les chargeurs fournis. L'état de charge actuel des accus est affiché à l'écran :



Plein



Vide

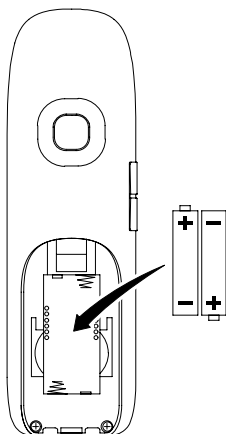

Régler la langue affichée

Sélectionnez votre langue. Le pages 68 et 70 vous donneront la position dans le menu.

CB : > Conf. comb. > Langue >...

BS : > Config. base > Langue >...

9 langues sont disponibles : allemand, français, italien, anglais, espagnol, portugais, néerlandais, polonais et turc.

Régler la date et l'heure

Vous réglez la date et l'heure dans le menu (Régl. heure) page 67.

Validez la saisie de l'année, du mois, du jour, de l'heure et de la minute avec la touche ou . Tenez compte du format de la date et de l'heure que vous avez réglé page 67. Si vous avez réglé le format 12 heures sélectionnez avec les touches / si l'heure réglée signifie avant midi (A) ou après-midi (P).

Installations PABX

La page 92 vous fournit de plus amples informations au cas où vous désireriez raccorder votre téléphone à une installation PABX.

Réduction du rayonnement (mode ÉCO)

Comparé aux téléphones sans fil DECT standard, le rayonnement est considérablement réduit en mode veille quand le combiné repose sur la station d'accueil. En mode de communication, le rayonnement est réduit en fonction de l'éloignement du combiné par rapport au téléphone (à la base).



Éléments de manipulation

3 Éléments de manipulation

Dans ce guide de l'utilisateur, les touches du téléphone sont représentées par des icônes standardisées encadrées. Il peut donc y avoir de légères différences entre les icônes des touches de votre téléphone et celles des touches utilisées ici.

Appareil de base

- | | | | |
|----|---|----|---|
| 1 | Combiné | 11 | Touche «vers l'avant» |
| 2 | Touche OK/Menu | 12 | Signalisation optique d'appel (LED appel) |
| 3 | Écran | 13 | Microphone |
| 4 | Touche «Retour» | 14 | Touche «mains-libres» |
| 5 | Touches de sélection directe (M1) (M2) | 15 | Touche «dièse» |
| 6 | Touche «Activer/Desactiver» le répondeur | 16 | Touche R/Effacement (R) |
| 7 | Touche «vers le haut», journal des appels | 17 | Touche «Répétition des derniers numéros» |
| 8 | Touche «Lecture/Stop» | 18 | Touche INT |
| 9 | Touche «vers le bas», d'accès au répertoire | 19 | Touche «Étoile» |
| 10 | Touche «Retour» | 20 | Clavier numérique (1), (2), (3) etc. |

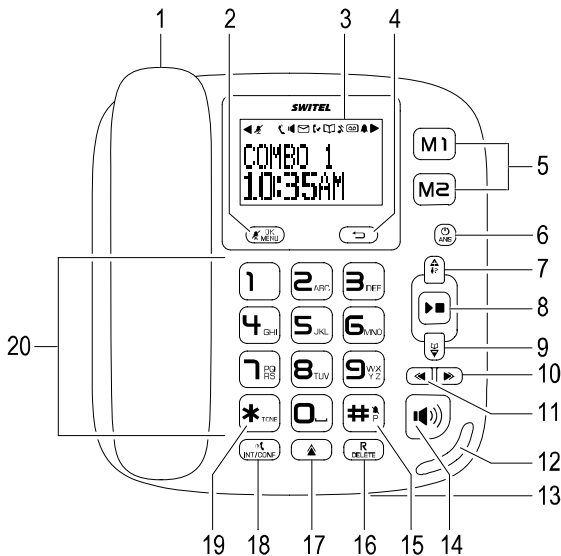

Éléments de manipulation





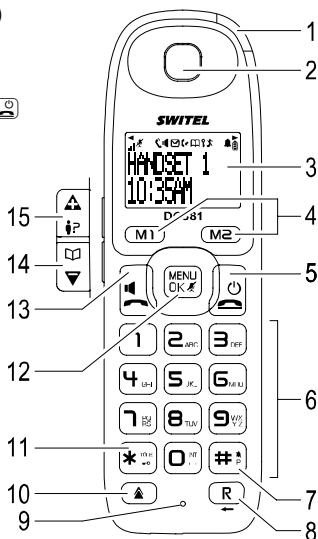









Combiné

- 1 Signalisation optique d'appel (LED appel)
- 2 Écouteur
- 3 Écran graphique
- 4 Touches de sélection directe (M1) (M2)
- 5 Touche «Raccrocher»/Allumer/Éteindre
- 6 Clavier numérique (1) (2) ... à (0)
- 7 Touche «dièse» / Sonn. désact. / Pause numérotation (#)
- 8 Touche R / Retour (R)
- 9 Microphone
- 10 Répétition des derniers numéros
- 11 Touche «Étoile» (*)
- 12 Touche Menu/OK/ Couper le microphone (MENU OK)
- 13 Touche «Décrocher» / Mode mains-libres
- 14 Touche fléchée «vers le bas» / Répertoire
- 15 Touche fléchée «vers le haut» / Journal des appels



Éléments de manipulation

Icônes et textes affichés

Icône	Description
 	État de charge de l'accu (plein, à moitié plein, presque vide). Vide : les accus doivent être rechargés. Segments continus : les accus se rechargent ☞ page 58. Segments constants : les accus sont totalement rechargés
	Connexion à la base. Clignote : connexion faible ou aucune connexion. Constante : bonne connexion.
	Clignote : appel en cours ☞ page 71. Continue : vous téléphonez ☞ page 71.
	Appels en absence. Vous avez de nouveaux appels dans le journal des appels ☞ page 79.
	Vous vous trouvez dans le répertoire ☞ page 75.
	Le contact ou l'affichage continue vers la droite ☞ page 76.
	Le contact ou l'affichage continue vers la gauche ☞ page 76.
	Constante : répondeur activé ☞ page 83. Clignote : nouveaux messages sur le répondeur ☞ page 85. Ou : la capacité de la mémoire du répondeur est épuisée. Effacez des messages ☞ page 86
	La sonnerie est désactivée ☞ page 74.
	Le microphone est programmé sur muet ☞ page 75.
	Le mode mains-libres est activé ☞ page 75.
	Le verrouillage du clavier est activé ☞ page 71.
	Le réveil est activé ☞ page 81.
	Répondeur dans le réseau téléphonique. VMWI - Service confort de votre opérateur ☞ page 93.

Introduction

4 Introduction

Dans ce chapitre, vous trouverez des informations de base vous expliquant comment vous servir du guide de l'utilisateur.

Représentations dans le guide

Représentation	Description
	Représentation des touches
	Appuyer brièvement sur la touche représentée
	Appuyer brièvement sur une touche quelconque
2 sec.	Appuyer 2 secondes sur la touche représentée
	Saisir des chiffres ou des lettres
	Le combiné sonne
	Le téléphone sonne
	Décrocher le téléphone ou retirer le combiné de la station d'accueil
	Raccrocher ou poser le combiné dans sa station d'accueil
	Représentation des textes affichés
	Représentation des icônes affichées
CB1 / CB2	Combiné 1, Combiné 2 etc.
BS	Base

Mode veille

Toutes les descriptions contenues dans ce guide partent du principe que le téléphone (la base) et le combiné se trouvent en mode veille. Le téléphone (la base) et le combiné se trouvent en mode veille quand vous ne téléphonez pas et quand aucun menu n'est ouvert.

Navigation dans le menu

Vous pouvez accéder à toutes les fonctions dans différents menus. La structure de menu vous montre comment accéder à la fonction voulue ➔ page 64.



Chaque opération est automatiquement interrompue si vous n'effectuez pas de saisie dans les 20 secondes.



Ouvrir le menu principal



Sélectionner l'option voulue

¹ Des lettres sont gravées sur les touches numériques. En appuyant plusieurs fois sur la touche adéquate, vous pouvez saisir des lettres, des chiffres et des caractères spéciaux.

	Ouvrir le sous-menu
	Sélectionner la fonction voulue
	Ouvrir la fonction
	Sélectionner le réglage voulu
	Saisir des chiffres ou des lettres via le pavé numérique
	Confirmer les entrées
	Reculer d'un niveau
	Annuler les actions de programmation et de sauvegarde et retourner en mode veille



De nombreuses saisies terminées avec la touche sont confirmée par un bip sonore.

Ajouter un contact dans le répertoire - exemple

L'exemple **Ajouter des contacts dans le répertoire** (combiné) vous explique ici comment naviguer dans les menus et effectuer des réglages. Procédez comme dans cet exemple pour tous les réglages.







	Ouvrir le menu principal
Répertoire	Ouvrir le répertoire
Ajouter	Sélectionner le sous-menu et valider
Entrez nom	Saisir le nom (max. 12 caractères) et valider
Numéro	Saisir le numéro d'appel 1 (portable) (max. 24 chiffres) et valider
Numéro	Saisir le numéro 2 (fixe) (max. 24 chiffres) et valider
Mélodie VIP	Attribuer une mélodie de sonnerie
	Retourner au mode veille



Vous pouvez sauvegarder 2 numéros de téléphone par nom ou contact. L'icône d'un portable précède la première place de mémoire, l'icône d'une maison précède la deuxième. C'est pourquoi nous recommandons de programmer seulement des numéros de portable pour la première place de mémoire et seulement des numéros de fixe pour la deuxième.

Structure de menu

5 Structure de menu

Vous parvenez au menu principal en appuyant sur la touche  ou . Ensuite sélectionnez avec les touches  /  un contact et validez votre sélection avec la touche  ou . Pour d'autres informations relatives au menu et à la manipulation, se reporter au  chapitre 4.

Répondeur

Mode répond.	Rép. &enreg.
	Rép. seule
	Désactivé
Supp.anciens	
Enreg. mémo	
Annonce 1	
	Écouter ann.
	Suppr. MSG
	Enreg. ann.
Annonce 2	
	Écouter ann.
	Suppr. MSG
	Enreg. ann.
Écran appels	Activé / Désactivé
1ere. sonn.	
	Économie
	08 Sonneries
	06 Sonneries
	04 Sonneries
	02 Sonneries

Structure de menu

Durée mess.	180 Sec
	150 Sec
	120 Sec
	90 Sec
Langue	Français
	FRANÇAIS
	NEDERLANDS
	ITALIANO
PIN distance	

Interphone



Combiné 01 à 06 ¹

¹ Affichage selon le nombre de combinés déclarés



Structure de menu

Répertoire

Ajouter

Entrez nom	 ¹
Numéro	
Numéro	
Mélodie VIP	01 / 02 / ... / Désactivé

Modifier

Entrez nom	 ¹
Numéro	
Numéro	
Mélodie VIP	01 / 02 / ... / Désactivé

Supprimer

Tout suppr.

Copier dans

M1

M2

MÉMOIRE

¹ Des lettres sont gravées sur les touches numériques. En appuyant plusieurs fois sur la touche adéquate, vous pouvez saisir des lettres, des chiffres et des caractères spéciaux.

Structure de menu

Horl./Réveil

Régl. réveil

Une fois

Désactivé

Activé Entrez heure 

Chaque jour

Désactivé

Activé Entrez heure 

Format date

JJ/MM

MM/JJ

Format heure

24 heures

12 heures

Régl. heure ¹





¹ Vous réglez la date et l'heure dans ce menu.

Structure de menu

Disponible seulement sur un combiné :

Conf. comb.

Sons comb.	
Volume comb.	05 / ... / 01 / Désactivé
Sonn. ext.	12 / ... / 01
Sonn. int.	12 / ... / 01
Bip touches	Désactivé / Bip / Mélod. sonn.
Pile faible	Activé / Désactivé
Hors portée	Activé / Désactivé
Égaliseur	
	Naturel
	Basses
	Aigus
Contrast.LCD	06 / ... / 01
Nom comb.  ²	
Décroch.auto	Activé / Désactivé
Appel bébé	
	Désactivé
	Activé Entrez num. 
Verrou. auto	Activé / Désactivé
Langue	(9 langues)

¹ Cette option est affichée seulement sur le combiné.

² Des lettres sont gravées sur les touches numériques. En appuyant plusieurs fois sur la touche adéquate, vous pouvez saisir des lettres, des chiffres et des caractères spéciaux.

Structure de menu

Disponible seulement sur un combiné :

Config. base ¹

Effac. VMWI

Associer

Base 1 PIN ? PIN ?²

Base 2 PIN ? PIN ?²

Base 3 PIN ? PIN ?²

Base 4 PIN ? PIN ?²

Sélect. base

Base 1

Base 2

Base 3

Base 4

Auto

Avancé

Mode numér. Fréq. voc. / Impulsions

Délai flash Court / Moyen / Long

Préfixe 

Blocage app. 04 / ... / 01 
Entrez num. 

Numéro SOS 04 / ... / 01 
Entrez num. 

Annuler com Combiné

Changer PIN PIN ? 

Réinit. Confirmer ?

¹ Cette option est affichée avec exactement les sous-menus seulement sur le combiné.

² Le code PIN est configuré en usine sur "0000".

Structure de menu

Disponible seulement sur l'appareil de base :

Config. base ¹

Mélodie

Volume comb. 05 / ... / 01 / Désactivé

Sonn. ext. 12 / ... / 01

Sonn. int. 12 / ... / 01

Bip touches Désactivé / Bip / Mélod. sonn.

Contrast.LCD 06 / ... / 01

Effac. VMWI 06 / ... / 01

Langue (9 langues)

Associer

Base 1 PIN ? PIN ?²

Base 2 PIN ? PIN ?²

Base 3 PIN ? PIN ?²

Base 4 PIN ? PIN ?²

Avancé

Mode numér. Fréq. voc. / Impulsions

Délai flash Court / Moyen / Long

Préfixe 

Blocage app. 04 / ... / 01 
Entrez num. 

Numéro SOS 04 / ... / 01 
Entrez num. 

Annuler com Combiné

Changer PIN PIN ?

Réinit. Confirmer ?

¹ Cette option est affichée avec exactement les sous-menus seulement sur l'appareil de base.

² Le code PIN est configuré en usine sur "0000".

6 Utilisation

Vous pouvez utiliser de nombreuses fonctions aussi bien de l'appareil de base que du combiné. Veuillez tenir compte que beaucoup des touches représentées par la suite se trouvent tant sur l'appareil de base que sur le combiné ☞ page 59.



Vous ne pouvez pas basculer d'un déroulement d'une utilisation de l'appareil de base sur celui du combiné. Avant de commencer le déroulement d'une utilisation, décidez-vous si vous voulez le faire sur l'appareil de base ou sur le combiné.

Allumer et éteindre le combiné

Vous ne pouvez pas recevoir d'appels sur le combiné quand celui-ci est éteint.

Les accus ne s'usent pas quand celui-ci est éteint.



Vous ne pouvez pas passer d'appel d'urgence avec le combiné quand celui-ci est éteint. Il faut d'abord l'allumer, ce qui peut prendre un certain temps.

2 sec.

Allumer le combiné (en mode veille)

2 sec.

Éteindre le combiné

Verrouillage du clavier

Le verrouillage du clavier est censé empêcher que des fonctions soient déclenchées par inadvertance.

1 sec.

Activer le verrouillage du clavier



Lorsque le verrouillage du clavier est activé, vous pouvez comme d'habitude réceptionner des appels entrants. Vous pouvez également effectuer des appels d'urgence (avec les numéros d'urgence), même si le clavier est verrouillé.

1 sec.

Désactiver le verrouillage du clavier

Si le verrouillage du clavier est activé, l'icône s'affiche.

Vous pouvez programmer le téléphone de la sorte que le verrouillage du clavier soit activé automatiquement au bout de 90 secondes ☞ page 81.

Téléphoner

Prendre un appel

En plus de la sonnerie, la signalisation optique d'appel s'allume à chaque appel.

), ou

Prendre l'appel



Ne placez pas le combiné qui sonne trop près de votre oreille, vous pourriez endommager votre audition !

Si vous avez activé la prise d'appel automatique, il vous suffit de retirer le combiné de la station d'accueil pour prendre cet appel ☞ page 81.

Terminer la communication

ou

Raccrocher

Pour terminer la communication, reposer le combiné sur la station d'accueil.

Utilisation



Émettre un appel

 Composer le numéro d'appel (max. 48 chiffres)

 Si la saisie est erronée, effacer le dernier chiffre



 ou  ou  Composer le numéro



Vous pouvez également appuyer d'abord sur la touche du combiné  ou décrocher le combiné de l'appareil de base ou bien encore appuyer sur la touche , vous obtenez la tonalité. Les chiffres saisis de votre numéro d'appel (max. 48 chiffres) sont immédiatement composés. La correction individuelle des chiffres du numéro d'appel n'est pas possible quand la communication est établie de cette manière.

Répétition des derniers numéros

Votre combiné enregistre les 5 derniers numéros composés avec date et heure de l'appel. Si vous souhaitez composer une nouvelle fois les numéros, p. ex. parce que la ligne était occupée ou parce que vous n'avez pas pu atteindre votre correspondant, utilisez la touche de répétition des derniers numéros :



,  /  Ouvrir la liste de répétition des derniers numéros et sélectionner un contact

 ou  ou  Établir la communication

Le numéro enregistré est automatiquement composé et la communication établie.

Rappeler des appels entrés



Votre téléphone enregistre 40 numéros dans un journal des appels.

,  /  Ouvrir le journal des appels et sélectionner un contact

 ou  ou  Établir la communication

Composer des numéros à partir du répertoire

Vous devez avoir enregistré des numéros dans le répertoire  page 76.

,  /  Ouvrir le répertoire et sélectionner le contact

 ou  ou  Établir la communication



Pour avoir accès plus rapidement à un contact du répertoire, appuyez, répertoire ouvert, sur la touche avec l'initiale du contact. Le premier contact ayant cette initiale s'affiche et est en surbrillance.

Composer des numéros avec les touches de sélection directe

Vous devez avoir mémorisé des numéros sur ces touches  page 77.

 ou  Établir la communication

Le numéro enregistré est composé automatiquement.

Téléphoner en interne

Vous devez avoir déclaré au moins un combiné à l'appareil de base pour téléphoner gratuitement en interne.

Téléphoner en interne

CB 1 : ou BS :	
/ Interphone , ou	Activer une communication en interne
CB1/BS : / , ou	Sélectionner le combiné voulu ou l'appareil de base
CB2 :	Prendre une communication interne sur un autre combiné
CB1/BS / CB2 :	Terminer une communication interne



Si le combiné que vous voulez appeler téléphone en externe, vous entendez un bip et vous voyez sur l'écran Ligne occupé..

Prendre des appels externes pendant une communication interne



Si un appel externe entre pendant que vous téléphonez en interne, un message s'affiche à l'écran.

	Prendre la communication externe
Sur le combiné qui n'a pas pris la communication, appuyez sur la touche pour terminer la communication interne.	

Transférer des communications externes en interne

CB 1 : ou BS :	
/ , Interphone , ou	Pendant la communication externe
/ , ou	Sélectionner le combiné voulu ou l'appareil de base
CB2 :	Prendre une communication interne sur un autre combiné
CB1 : ou BS :	Transférer la communication (raccrocher)

Intercommunication / Va-et-vient

CB 1 : ou BS :	
/ , Interphone , ou	Pendant la communication externe
/ , ou	Sélectionner le combiné voulu ou l'appareil de base
CB2 :	Prendre une communication interne sur un autre combiné
CB 1 : ou BS : , / Vat et vient	
ou	Changer de correspondant

Mener des conférences téléphoniques

Une communication externe peut être transformée en conférence téléphonique avec un autre correspondant interne.

CB 1 : ou BS :	
/ , Interphone ,	Pendant la communication externe
/ ,	Sélectionner le combiné voulu ou l'appareil de base

Utilisation

CB2 :  Prendre une communication interne sur un autre combiné

CB1 ou BS : 2 sec.  **Conférence** Conférences téléphoniques



CB1 ou BS et CB2 :  Terminer la conférence

Affichage de la durée de la communication

Quelques secondes après le début de la communication l'écran affiche la durée actuelle de la communication en minutes et secondes.

Régler le volume sonore de l'écouteur

Pendant une communication vous pouvez régler le volume sonore sur 5 sensibilités.

 /  Augmenter / Diminuer le volume de l'écouteur

Volume de la sonnerie d'appel

Vous pouvez modifier séparément le volume de la sonnerie de l'appareil de base et du combiné. Vous pouvez régler le volume sonore sur 5 sensibilités et couper le son.



Réglage du volume de la sonnerie du combiné

 Ouvrir le menu

 /  **Conf. comb.**  Conf. comb.

 /  **Sons comb.**  Sons comb.

 /  **Volume comb.**  Volume comb.

  /  Augmenter / Diminuer le volume de la sonnerie

 Enregistrer le réglage



Régler le volume de la sonnerie de l'appareil de base

 Ouvrir le menu

 /  **Config. base**  Config. base

 /  **Mélodie**  Mélodie

 /  **Volume comb.**  Volume comb.

  /  Augmenter / Diminuer le volume de la sonnerie

 Enregistrer le réglage

Activer et désactiver la sonnerie

3 sec.  Désactiver la sonnerie

3 sec.  Activer la sonnerie

Si la sonnerie est désactivée, l'icône  s'affiche.

Vous pouvez également désactiver la sonnerie via le menu.

Mode mains-libres

Utilisez cette fonction pour entendre le correspondant par l'intermédiaire du haut-parleur.



Activer le mode mains-libres pendant une communication



Désactiver le mode mains-libres pendant une communication

Si le mode mains-libres est activé, l'icône s'affiche.

Mettre le microphone en mode Muet

Vous pouvez désactiver et activer le microphone de l'appareil ou du combiné pendant une communication de sorte que votre correspondant ne vous entend pas quand, p. ex., vous désirez parler avec une autre personne se trouvant dans la pièce.



Désactiver le microphone pendant une communication (mode Muet)



Activer le microphone pendant une communication

Si le microphone est désactivé, l'icône s'affiche.

Répertoire

Vous pouvez sauvegarder 50 contacts avec 2 numéros de téléphone chacun dans le répertoire.

- Saisissez toujours les numéros d'appel avec l'indicatif afin que le téléphone puisse aussi attribuer les communications locales entrantes à un contact du répertoire.
- Si la capacité de mémoire est épuisée, l'écran affiche le message suivant Mém. pleine. Pour créer de la place, vous devez effacer un autre contact.
- Les contacts du répertoire sont classés par ordre alphabétique.

Si vous vous trouvez dans le répertoire, l'icône s'affiche.

Vous avez accès au répertoire depuis l'appareil de base et le combiné.

Saisir un nom

Des lettres sont gravées sur les touches numériques. En appuyant plusieurs fois sur la touche adéquate, vous pouvez saisir des lettres, des chiffres et des caractères spéciaux.



Entrer des espaces



Entrer des caractères spéciaux



Effacer



Déplacer le curseur



Pour saisir deux fois la même lettre, appuyez sur la touche correspondante. Attendez que le curseur soit passé derrière la lettre. Puis tapez celle-ci une nouvelle fois.

Utilisation

Ajouter des contacts dans le répertoire

également page 63

	Ouvrir le répertoire	
ou	Ajouter	
ou	Sélectionner le sous-menu et valider	
Entrez nom	ou	Saisir le nom (max. 12 caractères) et valider
Numéro	ou	Saisir le numéro d'appel 1 (portable) (max. 24 chiffres) et valider
Numéro	ou	Saisir le numéro d'appel 2 (fixe) (max. 24 chiffres) et valider
Mélodie VIP , / , ou	Attribuer une mélodie de sonnerie	

Si les contacts sont plus longs que l'écran peut les afficher, les icônes ◀ et ▶ s'affichent. Elles montrent que le contact dépasse l'écran vers la gauche ou vers la droite.

Si la capacité de mémoire est épuisée, l'écran affiche le message suivant **Mém. pleine** . Pour créer de la place, vous devez effacer un autre contact.









Si un nom existe déjà sous lequel vous voulez enregistrer un nouveau contact, l'écran affiche le message suivant lors de l'enregistrement : **Nom existe** .

Modifier des contacts du répertoire

	Ouvrir le répertoire	
/ , ou	Sélectionner le contact et valider	
/ Modifier ou	Sélectionner le sous-menu et valider	
Entrez nom	ou	Modifier le nom (max. 12 caractères) et valider
Numéro	ou	Modifier le numéro d'appel 1 (portable) (max. 24 chiffres) et valider
Numéro	ou	Modifier le numéro d'appel 2 (fixe) (max. 24 chiffres) et valider
Mélodie VIP , / , ou	Attribuer une mélodie de sonnerie	

Effacer des contacts du répertoire











Effacer un contact

	Ouvrir le répertoire
 /  ,  ou 	Sélectionner le contact et valider
 /  ? Supprimer  ou 	sélectionner le sous-menu et valider









Pour avoir accès plus rapidement à un contact du répertoire, appuyez, répertoire ouvert, sur la touche avec l'initiale du contact. Le premier contact ayant cette initiale s'affiche et est en surbrillance.

Effacer tous les contacts



	Ouvrir le répertoire
 ou 	Ouvrir le menu
 /  ? Tout suppr.  ou 	sélectionner le sous-menu et valider
Confirmer ? ,  ou 	
Vide	Confirmer l'effacement
ou	
Confirmer ? ,  ou 	Annuler l'effacement















Vérifier la capacité du répertoire

Consultez combien de contacts sont encore libres sur les 50.

	Ouvrir le répertoire
 ou 	Ouvrir le menu
 /  , MÉMOIRE  ou 	sélectionner le sous-menu et valider

Programmer les touches de sélection directe

Vous avez la possibilité de mémoriser 2 numéros du répertoire de la sorte que vous puissiez les composer en n'appuyant que sur la touche  ou  (sélection directe).

	Ouvrir le répertoire
 /  ,  ou 	Sélectionner le contact et valider
 /  ? Copier dans  ou 	sélectionner le sous-menu et valider
M1  ,  ou 	Sélectionner la touche de sélection directe et valider
 ou 	Confirmer le numéro affiché

Composer un numéro avec la touche de sélection directe

Utilisation

Liste de répétition des derniers numéros

Votre combiné enregistre les 5 derniers numéros composés avec date et heure de l'appel.

Enregistrer dans le répertoire un numéro de la liste de répétition des derniers numéros composés

	Ouvrir la liste des derniers numéros composés
/ , ou	Sélectionner le contact et valider
/ , Enreg. num. ou	sélectionner le sous-menu et valider
Entrez nom ou	Saisir le nom (max. 12 caractères) et valider
Entrez num. ou	Modifier le cas échéant le numéro d'appel (max. 24 chiffres) et valider
/ , ou	Constater si le numéro est un numéro de portable ou de fixe et valider

Effacer un numéro de la liste de répétition des derniers numéros composés

	Ouvrir la liste des derniers numéros composés
/ , ou	Sélectionner le contact et valider
/ , Supprimer ou	Sélectionner le sous-menu et valider

Effacer toute la liste de répétition des derniers numéros composés

	Ouvrir la liste de répétition des derniers numéros composés
ou	Ouvrir le menu
/ , Tout suppr. ou	Sélectionner le sous-menu et valider
Confirmer ? , ou	
Vide	Confirmer l'effacement
ou	
Confirmer ? , ou	Annuler l'effacement

Composer un numéro de la liste de répétition des derniers numéros composés

page 72

Journal des appels



Tous les appels entrant pendant votre absence sont rassemblés dans un journal des appels. Vous pouvez y enregistrer jusqu'à 40 numéros. La date et l'heure de chaque appel sont conservées.

Si vous vous trouvez dans le journal des appels, l'icône  s'affiche.

Le dernier numéro composé s'affiche en premier dans le journal des appels.



Si, pendant votre absence, de nouveaux numéros d'appel ont été enregistrés, la signalisation optique d'appel clignote ainsi que l'icône  à l'écran. L'écran affiche en outre combien vous avez eu d'appels en absence tant que vous n'avez pas ouvert le journal des appels.

Faire afficher des numéros du journal des appels

 /  /  Ouvrir le journal des appels et sélectionner un contact



Sauvegarder dans le répertoire des numéros du journal des appels





Vous pouvez enregistrer un numéro dans le répertoire directement de la liste des appels.





 /  /  Ouvrir le journal des appels et sélectionner un contact

 ou  Ouvrir le menu

 /  **Enreg. num.**  ou  Sélectionner le sous-menu et valider

Entrez nom     ou  Saisir le nom (max. 12 caractères) et valider

Entrez num.     ou  Modifier le cas échéant le numéro d'appel (max. 24 chiffres) et valider



 /    ou  Constater si le numéro est un numéro de portable ou de fixe et valider

Effacer des numéros du journal des appels

Effacer des numéros individuels

 /  /  Ouvrir le journal des appels et sélectionner un contact

 ou  Ouvrir le menu

 /  **Supprimer**  ou  Sélectionner le sous-menu et valider

Effacer tous les numéros d'appel

Ouvrir le journal des appels

 ou  Ouvrir le menu

 /   **Tout supr.**  ou  Sélectionner le sous-menu et valider

Confirmer ?  ou  **Vide** Confirmer l'effacement

ou

Confirmer ?  ou  Annuler l'effacement

Rappel des appels entrés

 page 72

Utilisation

Réglages du son et de l'affichage

Vous pouvez effectuer différents réglages pour installer le téléphone selon vos besoins :

Régler la sonnerie

Fixez pour les appels externes et internes la sonnerie devant toujours utilisée. 12 sonneries polyphoniques sont disponibles.

Programmer la sonnerie ☞ Menu page 68

Son des touches

Le son des touches vous confirme que vous avez bien appuyé sur la touche. Vous pouvez programmer le téléphone de la sorte qu'en appuyant sur une touche quelconque, vous entendiez toujours le même son (réglage Bip) ou des sons différents (réglage Mélodie). Le son des touches peut également être désactivé.

Programmer le son des touches ☞ Menu page 68

Signal d'avertissement de la faible capacité des accus

Un signal d'avertissement vous informe que la capacité des accus est faible.

Programmer le signal d'avertissement de la faible capacité des accus (Pile faible)

☞ Menu page 68

Signal sonore d'avertissement hors de portée :

Un signal d'avertissement vous informe que vous vous écartez avec votre combiné de la portée de l'appareil de base.

Régler le signal d'avertissement (Hors portée) ☞ Menu page 68

Égaliseur

Adaptez le son du haut-parleur à votre convenance. Laissez le son Naturel ou soulignez les Bases ou les Aigus.

Régler l'égaliseur ☞ Menu page 68

Régler le contraste de l'écran

Vous pouvez modifier le contraste de l'écran (Contrast.LCD) de l'appareil de base et du combiné sur 6 niveaux ☞ Menu page 68 et 70

Nom du combiné

Vous pouvez donner un nom à votre combiné (Nom comb). Menu page 68

Format de l'heure et de la date

Fixez le format et l'ordre dans lesquels vous voulez voir s'afficher la date et l'heure

☞ Menu page 67

Autres réglages

Prise d'appel automatique

Si vous avez activé cette fonction, l'appel sera automatiquement pris lorsque vous retirerez le combiné de la base. La prise d'appel automatique s'active ou se désactive via le menu.

Activer la prise d'appel automatique ➤ Menu page 68



Vous pouvez appeler l'option de menu **Décroch.auto** uniquement dans le menu d'un combiné.

Verrouillage du clavier

Si ce réglage est activé, le verrouillage du clavier est automatiquement activé si vous n'appuyez pas sur une touche quelconque pendant 90 secondes. Si le verrouillage du clavier est activé, l'icône s'affiche.

Activer le verrouillage du clavier ➤ Menu page 68

Préfixe

Vous pouvez enregistrer un préfixe (Préfixe). Si vous appuyez un temps long sur la touche avant ou après avoir entré le numéro, il sera précédé de son préfixe. En appuyant sur la touche vous composez le numéro.

Modifier le préfixe ➤ Menu page 69

Modifier le code PIN

Vous avez besoin du code PIN pour déclarer vos combinés. Celui-ci est réglé à l'usine sur le "0000". Modifier le code PIN ➤ Menu page 69 (Menu de l'appareil de base)

Remise à zéro

Cette fonction vous permet de remettre votre téléphone aux réglages en usine.

Réinitialisation ➤ Menu page 69 et 70

Chercher le combiné (Paging)

Si vous avez égaré votre combiné, vous pouvez le retrouver facilement en l'appelant de l'appareil de base.



Conditions : le combiné est allumé, se trouve à l'intérieur de la portée de l'appareil de base, les accus ne sont pas vides et la sonnerie du combiné n'est pas désactivée. Le dernier signifie qu'à l'écran du combiné l'icône ne doit PAS être affichée.

BS :

Activer un appel interne

BS : /

Sélectionner le combiné à rechercher

BS :

Lancer l'appel de recherche

Fonctions spéciales

Réveil

Cette fonction permet que votre combiné vous réveille ou vous rappelle quelque chose à un moment précis. Si le réveil est activé, l'icône s'affiche. À l'heure de réveil programmée, vous entendrez la sonnerie sélectionnée pendant une minute. Le message **Réveil** s'affiche.

Utilisation

Régler le réveil

Vous pouvez choisir si vous désirez que le réveil vous réveille une seule fois (Une fois) ou si vous voulez qu'il vous réveille tous les jours (Chaque jour).



Programmer le réveil (Régl. réveil) ➤ Menu page 67

Terminer prématurément la sonnerie du réveil



Terminer la sonnerie du réveil

Appel bébé

Cette fonction vous permet de sauvegarder un numéro d'appel précis (max. 24 chiffres) qui sera automatiquement appelé en mode mains-libres quand vous appuierez sur une touche quelconque (sauf  et .

Si cette fonction est activée, l'affichage clignote en permanence à l'écran Appel bébé.

Activer l'appel bébé ➤ Menu page 68

Blocage d'appel

Le blocage d'appel empêche les combinés de composer des numéros qui commencent avec les chiffres que vous avez enregistrés. Vous pouvez enregistrer 4 numéros bloqués de chacun 8 chiffres.

Activer le blocage d'appel ➤ Menu page 69

Si vous composez un numéro bloqué, la communication ne sera pas établie. L'appareil émet un son d'avertissement et retourne en mode veille.

Numéro d'appel d'urgence

Vous pouvez enregistrer jusqu'à 4 numéros d'appel pouvant être composés malgré le blocage d'appel activé. La page 69 vous donnera la position dans le menu.

Système de numérotation

Vous pouvez utiliser votre téléphone tant avec les centrales téléphoniques analogiques (numérotation par impulsions / DC) qu'avec les nouvelles centrales téléphoniques numériques (numérotation par tonalité / FV). Le système de numérotation est programmé via le menu. La page 69 vous donnera la position dans le menu.



Si vous utilisez le téléphone en mode de numérotation par impulsions, vous pouvez pendant une communication basculer sur le mode numérotation par tonalité en appuyant sur la touche .

Affichage du numéro d'appel (CLIP)



L'affichage des numéros d'appel (CLIP) ainsi que celui de la date et de l'heure sont des services optionnels de votre opérateur. Veuillez lui demander de plus amples informations.

Si votre installation téléphonique dispose de la fonction CLIP (CLIP = Calling Line Identification Presentation), l'écran indique le numéro d'appel du correspondant à l'arrivée d'un appel dans la mesure où ce correspondant est favorable à la transmission de son numéro.



Si vous ne prenez pas l'appel, l'affichage est conservé sur l'écran pendant 6 secondes env. avant de retourner à l'affichage de l'heure et de la date.

7 Répondeur

Le répondeur enregistre 57 messages maximum (59 messages, y compris les textes d'annonce). La durée d'enregistrement maximum est de 15 minutes (y compris les textes d'annonce).

Si la capacité de la mémoire est saturée et ne permet plus de recevoir de nouveaux messages, plus aucun appel ne sera enregistré. Le répondeur bascule alors automatiquement en mode «Annonce simple».

Vous pouvez utiliser le répertoire depuis l'appareil de base et le combiné.

Activer / Désactiver le répondeur

Si le répondeur est activé, la touche «Lecture/Stop» de l'appareil de base est allumée en rouge. De plus, l'icône  est affichée en permanence à l'écran de l'appareil de base et des combinés déclarés.



En réglage usine, le répondeur est activé.

Activer / Désactiver le répondeur de l'appareil de base



Activer / Désactiver le répondeur

Activer le répondeur du combiné

, / Répondeur , , / Mode répond. , ,
 / Rép. &enreg. ou Rép. seule

 Menu page 64

Désactiver le répondeur du combiné

, / Répondeur , , / Mode répond. , ,
 / Désactivé ,

 Menu page 64

Modes de réponse

Votre répondeur met deux modes de réponse à votre disposition : le mode répondeur-enregistreur (Rép. &enreg.) et le mode annonce simple (Rép. seule). En mode répondeur-enregistreur l'appelant peut laisser un message. En mode annonce seule il ne peut pas laisser de message.

Sélectionner le mode de réponse

Sélectionnez le mode de votre choix  Menu page 64. Voir également le passage «Activer / Désactiver le répondeur» à la page 83.



En réglage usine, le mode répondeur-enregistreur est activé.

Répondeur

Texte d'annonce

Votre répondeur met à votre disposition deux textes d'annonce prédéfinis. Vous pouvez remplacer les deux textes d'annonce par vos propres textes.

En mode «répondeur-enregistreur», c'est le texte Annonce 1 qui est utilisé, en mode «annonce simple», c'est le texte Annonce 2 qui est utilisé.



Dès que vous enregistrez votre propre texte d'annonce, le répondeur n'utilise plus que celui-ci.

Si la mémoire du répondeur est pleine, c'est le texte d'annonce sans enregistrement qui se fera automatiquement entendre.

Langue des textes d'annonce

Vous pouvez modifier la réponse vocale des textes d'annonces pré-réglés. Vous disposez de 4 langues.

 , ou  /  /  **Répondeur** ,

 ou  ,  /  **Langue** ,

 ou  Ouvrir le sous-menu

 /  ,  ou  Sélectionner la langue et valider

Écouter le texte d'annonce

 Menu page 64 (Écouter ann.)

Enregistrer un texte d'annonce

Votre propre annonce ne peut pas dépasser 2 minutes.

 , ou  /  /  **Répondeur** ,

 ou  Ouvrir le sous-menu

 /  **Annonce 1**

ou **Annonce 2**  ou  Sélectionner le texte d'annonce

 ,  /  **Enreg. ann.** ,

 ou  Commencer l'enregistrement

 Dictier le texte d'annonce

 ou  Terminer l'enregistrement et enregistrer

Enregistrez le texte désiré en parlant clairement et distinctement dans le microphone de l'appareil de base (à l'avant de l'appareil) ou de votre combiné. Quand vous aurez terminé, l'annonce sera diffusée à voix haute.



Veillez à dicter des textes d'annonce de longueur suffisante (max. 2 minutes) si vous voulez utiliser les fonctions de la consultation à distance  "Consultation à distance" page 88.

Activer à nouveau le texte d'annonce standard

Si vous effacez votre propre texte d'annonce, le texte d'annonce standard sera réactivé.

L'effacement du texte d'annonce s'effectue au menu  Menu page 64 (Suppr. MSG).



Vous ne pouvez pas effacer les textes d'annonce standard.

Diffuser les messages enregistrés

Si vous avez de nouveaux messages, les signalisations optiques d'appel de l'appareil de base et des combinés déclarés clignotent et sur leur écran s'affiche l'icône . Sur l'écran de l'appareil de base et des combinés déclarés s'affiche de plus une information signalant le nombre de nouveaux messages.

Les messages entrés sont numérotés dans l'ordre de leur réception.





Ils sont diffusés dans le sens inverse : le message enregistré en dernier est diffusé en premier.

Le numéro du message ainsi que la date et l'heure de son enregistrement sont affichés pendant sa diffusion.























Les nouveaux messages sont d'abord diffusés. Pour écouter les anciens, lancez la diffusion des messages encore une fois.

Diffuser les messages sur l'appareil de base (via le haut-parleur)





	Écouter / Arrêter les messages
	Réentendre un message
2x 	Message précédent
	Message suivant

Diffuser les messages sur le combiné

 /  /  Écouter msg. /	
 Attendez	Diffuser les messages (via haut-parleur)
Options pendant la diffusion :	
	Ouvrir le menu
 /  Suppr. MSG / 	
Supprimé	Effacer le message
 /  Stop / 	Arrêter l'écoute
 /  Renvoyer MSG / 	Message suivant
 /  Répéter MSG / 	Diffuser le message actuel depuis le début
 /  MSG préc. / 	Message précédent

Répondeur

Vous pouvez également créer ces fonctions en appuyant sur des touches déterminées :

	Effacer le message
	Diffuser le message actuel depuis le début
2x 	Message précédent
	Arrêter la diffusion (Pause)
	Message suivant

Régler le volume de la diffusion des messages

Pendant une diffusion vous pouvez programmer le volume sur l'appareil de base sur 5 sensibilités.

	Augmenter / diminuer le volume
---	--------------------------------

Pendant une diffusion vous pouvez programmer le volume sur le combiné sur 5 sensibilités.

	Augmenter / diminuer le volume
---	--------------------------------

Effacer un message

Pendant la diffusion d'un message :

BS : 	Effacer le message
--	--------------------

ou

CB : 	Ouvrir le menu
--	----------------

CB :  /  Suppr. MSG 	
--	--

	Effacer le message
---	--------------------

ou

CB : 	Effacer le message
--	--------------------





Effacer tous les messages

Tous les anciens messages s'effacent.



Les messages effacés ne peuvent pas être restaurés !

 ou  ,  Supp.anciens ,
--



 ou  , Confirmer ? ,  ou 
--

Écoute amplifiée

Vous pouvez écouter des appels entrants sur l'appareil de base via le haut-parleur sans avoir besoin de décrocher. Pour cela vous devez avoir activé l'écoute amplifiée au menu

 Menu page 64 (Écran appels).



Pour modifier le volume pendant l'écoute amplifiée, appuyez sur les touches  et .

Intercepter un appel

Si le répondeur a déjà répondu à un appel, vous pouvez intercepter celui-ci. L'enregistrement du message est, dans ce cas, interrompu.

 ou  ou 	Intercepter l'appel
---	---------------------

Report de la prise d'appel

Définissez le nombre de fois que le téléphone doit sonner avant que l'appelant n'entende le texte d'annonce. Vous pouvez choisir entre 2, 4, 6 ou 8 sonneries d'appel  Menu page 64 (1ère sonn.).



En réglage usine, le répondeur est réglé sur 4 sonneries.

De plus, vous pouvez utiliser le paramètre **Économie** pour la consultation préalable à distance gratuite. Cette consultation préalable à distance vous permet de constater gratuitement si de nouveaux messages se trouvent sur votre répondeur. Si vous avez de nouveaux messages, votre appel sera pris au plus tard après la 2ème sonnerie. Si vous n'en avez pas, votre appel ne sera pris qu'après la 6ème sonnerie. Raccrochez avant la 6ème sonnerie. Ainsi, la communication ne sera pas facturée.

Autres informations relatives à la consultation à distance  page 88

Durée maximale d'enregistrement pour chaque message

Vous disposez de 4 durées d'enregistrement  Menu page 65 (Durée mess.)

Enregistrer un mémo

Un mémo est un message que vous pouvez laisser pour une autre personne et qui peut s'écouter comme un message reçu. Un mémo ne peut pas dépasser 3 minutes et est dicté sur le combiné.



Vous pouvez aussi enregistrer des mémos lorsque le répondeur est débranché.

 , ou  ,  /  **Répondeur** ,

 ou 

Ouvrir le sous-menu

 , ou  ,  /  **Enreg. mémo** ,

 ou 

Commencer l'enregistrement



Dicter le mémo

 ou 

Terminer l'enregistrement et enregistrer

Annuler l'enregistrement d'un mémo

BS : 

Annuler l'enregistrement et revenir au sous-menu

ou

CB :  ou 

Annuler l'enregistrement et revenir au sous-menu

Répondeur

Consultation à distance

Vous pouvez appeler votre répondeur pour l'activer ou pour écouter des messages et vous servir d'autres fonctions à condition que votre téléphone soit équipé de la fonctionnalité de numérotation par tonalité.

Code PIN pour la consultation à distance

Le PIN distance est configuré en usine sur le "1234". Il est recommandé de modifier le PIN distance afin qu'une personne non autorisée ne puisse avoir accès au répondeur.

Code PIN pour la consultation à distance ☞ Menu page 65.



Si vous avez modifié le code Pin pour la consultation à distance et qu'ensuite vous l'avez oublié, vous pouvez consulter ce dernier dans le menu ☞ Menu page 69 (PIN distance).

Démarrer la consultation à distance

Le téléphone que vous utilisez pour la consultation à distance doit être réglé sur la numérotation par tonalité.



Composer le propre numéro d'un raccordement téléphonique externe.



Si le répondeur est activé, le texte d'annonce sera diffusé après le nombre de sonneries réglé.

Si le répondeur n'est pas activé, le téléphone s'active automatiquement au bout de 10 sonneries et un long signal d'avertissement se fait entendre.



Activer la consultation à distance.

Ensuite un long signal d'avertissement se fait entendre.



Si le répondeur est activé, vous devez activer la consultation à distance tant que le texte d'annonce est diffusé. C'est pourquoi il est important que le texte d'annonce soit suffisamment long.



Entrer le code PIN à 4 chiffres pour la consultation à distance. Ensuite un long signal d'avertissement se fait entendre.

Vous avez maintenant la possibilité d'exécuter d'autres fonctions

☞ Tableau «Fonctions des touches de la consultation à distance» à la page 89.



Appuyez sur la touche I pour exécuter la fonction désirée. Ensuite un long signal d'avertissement se fait entendre.



Vous pouvez exécuter plusieurs fonctions l'une après l'autre.

Terminer la consultation à distance



Terminer la consultation à distance

Fonctions des touches de la consultation à distance

Le tableau suivant vous donne une vue d'ensemble des fonctions disponibles et sur quelle touche vous devez appuyer pour exécuter la fonction.

Touche	Quand <u>aucun</u> message n'est diffusé	Pendant la diffusion de messages
0		Effacer le message
1		Réentendre un message
2	Diffuser le message, continuer la diffusion	Arrêter la diffusion (Pause)
3		Écouter le message suivant
4	Brancher / Débrancher le répondeur	
5	Enregistrer un mémo ¹	
*		Terminer la diffusion

Activer le répondeur via la consultation à distance



Composer le propre numéro d'un raccordement téléphonique externe. Le téléphone s'active au bout de 10 sonneries et un long signal d'avertissement se fait entendre.



Activer la consultation à distance.
Ensuite un long signal d'avertissement se fait entendre.



Entrer le code PIN à 4 chiffres pour la consultation à distance. Ensuite un long signal d'avertissement se fait entendre.



Activer le répondeur
Ensuite un long signal d'avertissement se fait entendre.
Le texte d'annonce est diffusé.



Raccrocher / Terminer la communication

¹ Terminez l'enregistrement d'un mémo en terminant la consultation à distance.

Élargir le système téléphonique

Annuler des combinés



Vous pouvez annuler un combiné uniquement depuis l'appareil de base ou depuis un autre combiné déclaré sur ce dernier. Un combiné ne peut pas s'annuler lui-même.

Vous pouvez annuler les combinés au menu Menu page 69 et 70.

Sur l'appareil de base :

/ / , **Config. base** , Ouvrir le menu

/ / **Avancé** , Ouvrir le menu

/ / **Annuler com** , Ouvrir le menu

Combiné 0x / ,

Attendez Sélectionner le combiné et lancer l'annulation

Plusieurs stations de base¹/appareil de base²

Vous pouvez étendre la portée de votre combiné si vous le déclarez à plusieurs téléphones (bases¹/appareils de base²). Il peut être déclaré sur 4 téléphones différents (bases¹/appareils de base²). Chaque téléphone (chaque base¹/appareil de base²) nécessite sa propre prise téléphonique. Ces raccordements peuvent porter le même numéro d'appel ou bien des numéros différents.



Des communications en cours ne peuvent pas être transférés d'un téléphone à un autre (d'une base à une autre, d'un appareil de base à un autre).

¹ La base du DC 58x est désignée comme «base».

² La base du DC 587x est désignée comme «appareil de base».

Installations PABX / Services confort

Affichage du numéro d'appel (CLIP¹)



L'affichage du numéro d'appel est un service confort de votre opérateur. Veuillez lui demander de plus amples informations.

Si cette fonction est disponible sur votre ligne téléphonique, le numéro d'appel du correspondant sera affiché dès que le téléphone sonnera. Si votre correspondant a bloqué la transmission de son numéro, un message correspondant sera affiché. Le numéro ne peut pas être affiché et ne peut donc être enregistré dans la liste d'appels.

Répondeur dans le réseau téléphonique

Le répondeur dans le réseau téléphonique est un service confort offert par de nombreux opérateurs. Si votre opérateur met à votre disposition un répondeur dans le réseau téléphonique, vous serez informé par une icône de l'arrivée de nouveaux messages (**VMWI**²). Vous ne pouvez disposer de cette fonction que si votre opérateur offre ce service confort. Veuillez lui demander de plus amples informations.

¹ **CLIP** : Calling Line Identification Presentation = Affichage du numéro d'appel d'un correspondant.

² **VMWI** : Visual Message Waiting Indication = Affichage optique de nouveaux messages.

Caractéristiques techniques

10 Caractéristiques techniques

Caractéristique	Valeur
Standard	DECT ¹ -GAP ²
Alimentation en courant (appareil de base)	Entrée : 100-240 V, 50-60 Hz Sortie : 6 V, 500 mA
Alimentation en courant (station d'accueil)	Entrée : 100-240 V, 50-60 Hz Sortie : 6 V, 150 mA
Accus rechargeables	2 x 1.2 V 500 mAh NiMH, taille : AAA
Bande de fréquence	1880 - 900 MHz
Max. puissance de transmission	24 dBm
Portée du combiné	En extérieur : env. 300 m En intérieur : env. 50 m
Mode veille combiné	Jusqu'à 110 h
Autonomie max. en communication du combiné	Jusqu'à 11 h
Volume sonore max. de l'écouteur	30 dB
Système de numérotation	Numérotation par tonalité (FV) ou par impulsions (DC)
Temps de flash	Court, moyen, long
Langues des menus	Allemand, français, italien, anglais, espagnol, portugais, néerlandais, polonais et turc.
Code PIN (réglage usine)	0000
Nombre de sonneries	12 (polyphoniques)
Nombre max. de contacts dans le répertoire	50
Nombre max. de contacts dans le journal des appels	40
Nombre max. de contacts dans la répétition des derniers numéros	5
Nombre max. de messages sur le répondeur	57
Durée max. d'enregistrement sur le répondeur	15 min (y compris le texte d'annonce)
Langues des textes d'annonce standard	Allemand, français, italien, anglais
Code PIN pour la consultation à distance (réglage en usine)	1234

¹ DECT : Digital Enhanced Cordless Telecommunication = Norme de téléphonie numérique sans fil optimisée.

² GAP: Generic Access Profile = Standard pour l'action conjointe de combinés et de bases de fabricants différents.

Déclaration de conformité

Cet appareil répond aux exigences de la directive de l'Union européenne : 1999/5/CE : Directive sur les installations de radio et de télécommunication et la reconnaissance réciproque de leur conformité. La conformité avec la directive mentionnée ci-dessus est confirmée sur l'appareil par le symbole CE.



Ligne d'assistance directe

Si vous avez des problèmes avec votre téléphone, observez d'abord les remarques suivantes. S'il s'agit de problèmes techniques, vous pouvez vous adresser à notre ligne d'assistance directe en Suisse au numéro de tél. 0900 00 1675 (frais Swisscom à la date d'impression de ce manuel : CHF 2,60/min). Si vous jouissez de droits de garantie, adressez-vous à votre revendeur. La durée de la garantie est de 2 ans.

11 Problèmes

Questions	Réponses
Pas de communication téléphonique possible	<ul style="list-style-type: none">- Le combiné ou l'appareil de base n'est pas raccordé correctement ou est en dérangement. N'utilisez que le câble de raccordement téléphonique fourni avec l'appareil.- Le bloc secteur n'est pas branché ou il y a une panne totale de courant.- Testez avec un autre téléphone si votre raccordement téléphonique fonctionne.- Mauvais lieu d'installation de l'appareil de base- Les accus rechargeables sont vides ou défectueux.- Vous vous êtes trop éloigné de l'appareil de base avec un combiné. Vous pouvez augmenter la portée en déclarant un combiné à plusieurs appareils de base/bases ☞ page 91.- Réglage erroné du système de numérotation ☞ page 69.- Quand plusieurs combinés sont déclarés : une communication est passée sur un autre combiné.- Dans le cas de communications internes : le combiné appelé est en dehors de la portée de l'appareil de base.- Le verrouillage du clavier est activé.- Le combiné n'est pas allumé.
Pas de connexion possible à l'appareil de base	<ul style="list-style-type: none">- Vérifiez si vous avez déclaré un combiné sur l'appareil de base ou si vous avez bien déclaré ce combiné avec le code PIN correct ☞ page 69.
La liaison est hachée, coupée	<ul style="list-style-type: none">- Vous vous êtes trop éloigné de l'appareil de base.- Mauvais lieu d'installation de l'appareil de base.
Vous entendez des bips pendant une communication téléphonique	<ul style="list-style-type: none">- Vous vous êtes trop éloigné de l'appareil de base.- Les accus sont presque vides.

Problèmes

Questions	Réponses
Le système ne réagit plus	<ul style="list-style-type: none">- Remettez toutes les fonctions en configuration usine ☞ page 69.- Retirez le bloc secteur de la prise de courant pendant un court instant.
Les accus se déchargent très rapidement	<ul style="list-style-type: none">- Ceux-ci sont vides ou défectueux.- Posez le combiné correctement sur la base / station d'accueil. Nettoyez les surfaces de contact du combiné et de la base / station d'accueil avec un chiffon doux et sec.- Posez le combiné sur la base / station d'accueil pendant 8 heures.
Vous ne pouvez plus recharger les accus	<ul style="list-style-type: none">- Les accus sont défectueux.
L'affichage du numéro d'appel (CLIP) ne fonctionne pas	<ul style="list-style-type: none">- L'affichage du numéro d'appel est un service confort de votre opérateur. Veuillez lui demander de plus amples informations.- Le correspondant a bloqué la transmission de son numéro.
Le répondeur n'enregistre pas de messages	<ul style="list-style-type: none">- Contrôlez si le répondeur est activé.- Contrôlez si la mémoire du répondeur est pleine. Supprimez des messages, le cas échéant.
Vous ne pouvez pas commuter votre répondeur sur le mode annonce et enregistrer	<ul style="list-style-type: none">- Contrôlez si la mémoire du répondeur est pleine. Le répondeur bascule alors automatiquement en mode «Annonce simple» dans lequel vous ne pouvez pas enregistrer de message. Supprimez des messages, le cas échéant.
Vous ne pouvez pas consulter le répondeur à distance	<ul style="list-style-type: none">- Le téléphone que vous utilisez pour la consultation à distance doit être réglé sur la numérotation par tonalité.- Contrôlez si le répondeur est activé.- Contrôlez si vous utilisez bien le code PIN correct pour la consultation à distance ☞ page 88. Si vous avez oublié le code PIN pour la consultation à distance, vous pouvez consulter ce dernier dans le menu ou remettre le téléphone ou le code PIN en réglage usine pour la consultation à distance page .- Appuyez sur les touches lentement et suffisamment fort.- Lancez la consultation à distance pendant que le texte d'annonce est reproduit. Si la durée de la reproduction du texte d'annonce est trop courte, enregistrez un texte plus long.

12 Remarques d'entretien / Garantie

Remarques concernant l'entretien

- Nettoyez les surfaces du boîtier avec un chiffon doux et non pelucheux.
- N'utilisez pas de produits d'entretien ni de solvants.

À part un nettoyage occasionnel du boîtier, le téléphone ne nécessite pas d'entretien.

Garantie

Les appareils SWITEL sont fabriqués et contrôlés selon les procédés les plus modernes. Des matériaux sélectionnés et des technologies de haut niveau garantissent un fonctionnement irréprochable et une longue durée de vie. La garantie n'est pas valable si l'exploitant du réseau téléphonique ou une installation PABX éventuellement intercalée est responsable du dysfonctionnement de l'appareil. La garantie ne s'applique pas aux piles et accumulateurs ou packs d'accumulateurs utilisés dans les produits. La durée de la garantie est de 24 mois à partir de la date d'achat.

Pendant la période de garantie, tous les défauts dus à des vices de matériel ou de fabrication seront éliminés gratuitement. Le droit à la garantie expire en cas d'intervention de l'acheteur ou de tiers. Les dommages provenant d'un maniement ou d'une manipulation incorrects, d'une usure naturelle, d'une mauvaise mise en place ou d'une mauvaise conservation, d'un raccordement ou d'une installation incorrects ainsi que d'un cas de force majeure ou autres influences extérieures sont exclus de la garantie. En cas de réclamations, nous nous réservons le droit de réparer, de remplacer les pièces défectueuses ou d'échanger l'appareil. Les composants remplacés ou les appareils échangés deviennent notre propriété. Les demandes de dommages-intérêts sont exclues tant qu'elles ne reposent pas sur l'intention ou une négligence grossière du fabricant.

Si votre appareil devait malgré tout présenter une défectuosité pendant la période de garantie, veuillez vous adresser, muni de votre reçu, exclusivement au magasin où vous avez acheté votre appareil SWITEL. Vous ne pouvez faire valoir vos droits à la garantie selon ces dispositions qu'exclusivement auprès de votre revendeur. Deux ans après l'achat et la remise de nos produits, il n'est plus possible de faire valoir les droits en matière de garantie.

13 Index

A

- Accus, 94
- Accus rechargeables, 55
- Activer, 83
- Activer et désactiver la sonnerie, 74
- Activer le répondeur via la consultation à distance, 89
- Affichage du numéro d'appel, 93
- Affichage du numéro d'appel (CLIP), 82
- Ajouter des contacts dans le répertoire, 76
- Alimentation en courant, 94
- Annuler l'enregistrement d'un mémo, 87
- Annuler un combiné, 91
- Appareil de base, 59
- Appareils de base, 91
- Appareils médicaux, 55
- Appel bébé, 82
- Appel d'urgence, 82
- Appels en absence, 79
- Autonomie en veille, 94

B

- Bases, 91
- Bloc d'alimentation, 54
- Blocage d'appel, 82

C

- Charger les accus, 58
- Clavier numérique, 59, 60
- CLIP, 82, 93
- Code d'accès, 92
- Code PIN pour la consultation à distance, 88
- Code PIN pour la consultation à distance (réglage en usine), 94
- Code réseau, 92
- Combiné, 59, 60
- Compatibilité avec les prothèses auditives, 55
- Composer des numéros, 72
- Composer un numéro de la liste de répétition des derniers numéros composés, 78
- Conférences téléphoniques, 73
- Consignes de sécurité, 54
- Consultation à distance, 88
- Contacts dans le répertoire, 63
- Contenu du coffret, 56

D

- Déclaration de conformité, 95
- DECLARER, 90
- Déclarer un combiné, 90
- DECT, 94
- Démarrer la consultation à distance, 88
- Désactivation du microphone (Muet), 75
- Désactiver, 83
- Désactiver le microphone, 75
- Diffuser les messages sur l'appareil de base, 85
- Diffuser les messages sur le combiné, 85
- Durée d'enregistrement
 - pour chaque message, 87
- Durée de la communication, 74, 94
- Durée max. d'enregistrement
 - sur le répondeur, 94
- Durée maximum d'enregistrement, 83

E

- Économiseur de taxes, 87
- Écoute amplifiée, 86
- Écouter le texte d'annonce, 84
- Écouter les messages, 85
- Écouteur, 60
- Écran, 59, 61
- Écran graphique, 60
- Effacer des contacts du répertoire, 77
- Effacer des messages, 86
- Effacer des numéros du journal des appels, 79
- Effacer des numéros individuels, 79
- Effacer tous les contacts, 77
- Effacer tous les messages, 86
- Effacer tous les numéros d'appel, 79
- Effacer toute la liste de répétition des derniers numéros composés, 78
- Effacer un contact, 77
- Effacer un numéro de la liste de répétition des derniers numéros composés, 78
- Égaliseur, 80
- Élargir le système téléphonique, 90
- Éléments de manipulation, 59
- Émettre un appel, 72
- Enregistrer dans le répertoire, 78, 79
- Enregistrer dans le répertoire un numéro de la liste des derniers numéros composés, 78
- Enregistrer un mémo, 87
- Enregistrer un texte d'annonce, 84
- Entretien, 97
- État de charge, 58

F

- Faire afficher des numéros du journal des appels, 79
- Fonctions des touches de la consultation à distance, 89
- Fonctions spéciales, 81
- Format de l'heure et de la date, 80

G

- GAP, 94
- Garantie, 97

Index

I

- Icônes, 61
- Icônes affichées, 61
- Insérer les accus dans le combiné, 58
- Installations PABX, 58, 92
- Interception d'appel, 86
- Intercommunication, 73

J

- Journal des appels, 59, 60, 79

L

- Langue des textes d'annonce, 84
- Langues des menus, 94
- Langues des textes d'annonce standard, 94
- LED appel, 59, 60
- Lieu d'installation, 54
- Ligne d'assistance directe, 95
- Liste de répétition des derniers numéros composés, 78

M

- Menu principal, 64
- Microphone, 59, 60
- Mise en service, 56
- Mode ÉCO, 58
- Mode mains-libres, 60, 75
- Mode veille, 62
- Modifier des contacts du répertoire, 76
- Modifier le code PIN, 81

N

- Navigaison dans le menu, 62
- Nom du combiné, 80
- Nombre de contacts dans la répétition des derniers numéros, 94
- Nombre de contacts dans le journal des appels, 94
- Nombre de contacts dans le répertoire, 94
- Nombre max. de messages sur le répondeur, 94

O

- Options pendant la diffusion, 85

P

- Paging, 81
- Panne de courant, 54
- Pause de numérotation, 92
- PIN, 90, 94
- Plusieurs bases, 91
- Plusieurs combinés, 90
- Portée, 94
- Préfixe, 81
- Prendre des appels externes pendant une communication interne, 73
- Prendre un appel, 71
- Prise d'appel automatique, 81
- Problèmes, 95
- Programmer les touches de sélection directe, 77

Q

Que faire des appareils hors d'usage ?, 55

R

Raccorder l'appareil de base, 57
Raccorder la station d'accueil, 57
Rappel, 72
Rappeler des appels entrés, 72, 79
Rechercher le combiné, 81
Réduction du rayonnement, 58
Réglage du volume de la sonnerie du combiné, 74
Réglages du son et de l'affichage, 80
Régler l'heure, 58
Régler la date, 58
Régler la langue affichée, 58
Régler la sonnerie, 80
Régler le contraste de l'écran, 80
Régler le réveil, 82
Régler le volume de la diffusion des messages, 86
Régler le volume de la sonnerie de l'appareil de base, 74
Régler le volume sonore de l'écouteur, 74
Réinitialiser, 81
Remarques concernant l'entretien, 97
Répertoire, 59, 60, 72, 75
Répétition des derniers numéros, 60, 72
Répondeur, 83
Répondeur dans le réseau téléphonique, 93
Représentations dans le guide, 62
Réveil, 81

S

Saisie de texte, 75
Saisir un nom, 75
Sélection directe, 72
Sélectionner le mode de réponse, 83
Sélectionner les sous-menus, 63
Services confort, 92
Signal d'avertissement « hors de portée » : 80
Signal d'avertissement de la faible capacité des accus, 80
Signalisation optique d'appel, 60
Signalisation optique d'appel (LED appel), 59, 60
Son des touches, 80
Sonneries, 94
Structure de menu, 64
Système de numérotation, 82, 94

Index

T

- Téléphoner, 71
- Téléphoner en interne, 72, 73
- Temps de flash, 92, 94
- Terminer la communication, 71
- Terminer la consultation à distance, 88
- Terminer prématurément
la sonnerie du réveil, 82
- Texte d'annonce, 84
- Touche « Activer/Desactiver » le répondeur, 59
- Touche « Décrocher », 60
- Touche « dièse », 59
- Touche « dièse » / Sonn. désact. / Pause
numérotation, 60
- Touche « Étoile », 59, 60
- Touche « Lecture/Stop », 59
- Touche « mains-libres », 59
- Touche « Raccrocher »/Allumer/Éteindre, 60
- Touche « Répétition des derniers numéros », 59
- Touche « Retour », 59
- Touche « vers l'avant », 59
- Touche « vers le bas », 59
- Touche « vers le haut », 59
- Touche fléchée « vers le bas », 60
- Touche fléchée « vers le haut », 60
- Touche INT, 59
- Touche Menu/OK/Couper le microphone, 60
- Touche OK/Menu , 59
- Touche R, 59, 60, 92
- Touches de sélection directe, 59, 60
- Transférer des communications externes
en interne, 73
- Transfert de communication, 73

U

- Utilisation, 71
- Utilisation conforme aux prescriptions, 54

V

- Va-et-vient, 73
- Vérifier la capacité du répertoire, 77
- Verrouillage du clavier, 71, 81
- VMWI, 93
- Volume sonore max. de l'écouteur, 94

1	Indicazioni di sicurezza	104
2	Messa in funzione	106
3	Elementi di comando	109
4	Informazioni introduttive	112
5	Struttura di menu	114
6	Funzionamento	121
7	Segreteria telefonica	133
8	Ampliare il sistema telefonico	140
9	Impianti telefonici interni / Servizi aggiuntivi	142
10	Specifiche tecniche	144
11	Problemi	145
12	Consigli per la cura/Garanzia	147
13	Indice alfabetico	148

Indicazioni di sicurezza

1 Indicazioni di sicurezza

Leggere attentamente le presenti istruzioni per l'uso.

Scopo d'impiego

Il telefono munito di unità portatile consente di eseguire chiamate in una rete telefonica. Qualsiasi altro impiego è considerato non conforme agli usi previsti. Non sono consentite modifiche o trasformazioni non autorizzate. Non aprire per nessuna ragione l'apparecchio autonomamente, né compiere riparazioni di propria iniziativa.

Caduta di tensione

In caso di caduta di tensione, il telefono non consente di eseguire chiamate. Ricorrere in caso d'emergenza ad un telefono a filo in grado di funzionare anche senza alimentazione elettrica esterna.

Luogo di installazione

Il luogo di installazione influisce in modo decisivo sul corretto funzionamento del telefono.

Evitare un'esposizione a fumo, polvere, vibrazioni, sostanze chimiche, umidità, calore e raggi solari diretti. Non utilizzare il telefono in aree esposte al rischio di esplosioni.

Non posizionare il telefono nelle immediate vicinanze di altri dispositivi elettronici come ad es. televisori, forni microonde, frigoriferi e così via in modo da escludere eventuali interferenze reciproche. Evitare di posizionare il telefono in prossimità di un altro telefono. Assicurarsi che grossi oggetti metallici, come ad es. un frigorifero o uno specchio, non si trovino tra unità base e unità portatile. Anche eventuali pareti possono influire sulla qualità di collegamento tra unità base e unità portatile.

Posizionare il telefono in prossimità di una presa elettrica idonea e nelle vicinanze della presa telefonica. Fare attenzione a non inciampare sul cavo!



Attenzione: Non è consentito prolungare i cavi!

Poggiare il telefono su una superficie piana e antiscivolo. In generale, i piedini del dispositivo non lasciano tracce sulla superficie di appoggio. Vista la molteplicità di vernici e superfici non è comunque possibile escludere che i piedini del dispositivo lascino tracce sulla superficie di appoggio.

Più in alto si posiziona l'unità base (anche all'interno di uno stesso edificio), migliore è la sua portata.

Alimentatore di rete



Attenzione: Utilizzare solo l'alimentatore di rete fornito visto che altri alimentatori di rete potrebbero addirittura danneggiare il telefono. Non ostacolare il libero accesso all'alimentatore di rete con mobili o altri oggetti simili.

Indicazioni di sicurezza

Batterie ricaricabili



Attenzione: Non gettare le batterie ricaricabili nel fuoco. Utilizzare solo batterie ricaricabili dello stesso tipo. Osservare la corretta polarità! Pericolo di esplosione in caso di inversione della polarità durante la carica delle batterie ricaricabili.



Attenzione: Utilizzare solo le batterie ricaricabili consigliate. Non utilizzare altre batterie o pile. Pericolo di esplosione!

Apparecchiature mediche



Attenzione: Non utilizzare il telefono in prossimità di apparecchiature mediche. Non è possibile escludere il rischio di possibili interferenze.

Compatibilità con apparecchi acustici

Il telefono è compatibile con il maggior numero di apparecchi acustici presenti sul mercato. Ciò nonostante non è possibile garantire un perfetto funzionamento con qualsiasi tipo di apparecchio acustico.

Telefoni **DECT**¹ possono causare un fastidioso ronzio in apparecchi acustici.

Smaltimento

Smaltire l'apparecchio consegnandolo in uno dei punti di raccolta istituiti dalla propria società di smaltimento rifiuti comunale (ad es. centro di riciclo materiali). La legge sugli apparecchi elettrici ed elettronici prescrive ai proprietari di apparecchi esauriti la consegna di tutti gli **apparecchi elettrici ed elettronici** in un centro di rilievo rifiuti in raccolta differenziata. Il simbolo riportato qui a lato indica che non è assolutamente consentito smaltire l'apparecchio gettandolo nei rifiuti domestici!

Batterie ricaricabili e pile possono provocare danni alla salute e all'ambiente!

Non aprire, danneggiare, ingerire o disperdere nell'ambiente batterie ricaricabili e pile. Queste possono contenere metalli pesanti nocivi e dannosi per l'ambiente.

Per legge sussiste l'obbligo di smaltire correttamente batterie ricaricabili e pile utilizzando gli appositi contenitori di raccolta in uso presso i rivenditori di batterie. Lo smaltimento è gratuito. I simboli indicano che non è assolutamente consentito gettare batterie ricaricabili e pile nei rifiuti domestici, consegnandoli ai fini dello smaltimento nei rispettivi punti di raccolta.

Smaltire **confezioni ed imballaggi** secondo quanto indicato dalle norme in vigore a livello locale.



¹ DECT: Digital Enhanced Cordless Telecommunication = Standard per telefoni senza cavo

Messa in funzione

2 Messa in funzione

Indicazioni di sicurezza



Attenzione: Prima della messa in funzione, leggere attentamente le indicazioni di sicurezza nel capitolo 1.

Verificare il contenuto della confezione

La confezione include:

Contenuto	Modello DCT 587X			
	DCT 5871	DCT 5872 ¹	DCT 5873 ¹	DCT 5874 ¹
Unità base	1	1	1	1
Alimentatore di rete	1	1	1	1
Ricevitore	1	1	1	1
Cavo a spirale per ricevitore	1	1	1	1
Cavo di collegamento telefonico	1	1	1	1
Stazione di carica con alimentatore di rete	1	2	3	4
Unità portatile	1	2	3	4
Batterie ricaricabili (AAA 1,2 V NiMH)	2	4	6	8
Istruzioni per l'uso	1	1	1	1

¹ Per maggiori informazioni sulla disponibilità del telefono/set telefonico si prega di visitare il sito www.switel.com.

Mettere in funzione l'apparecchio

Collegare l'unità base

Procedere al collegamento dell'unità base secondo quanto raffigurato sul disegno. Per motivi di sicurezza si prega di utilizzare solo l'alimentatore di rete fornito in dotazione.

Osservare necessariamente le indicazioni relative al luogo di installazione ► pagina 104.

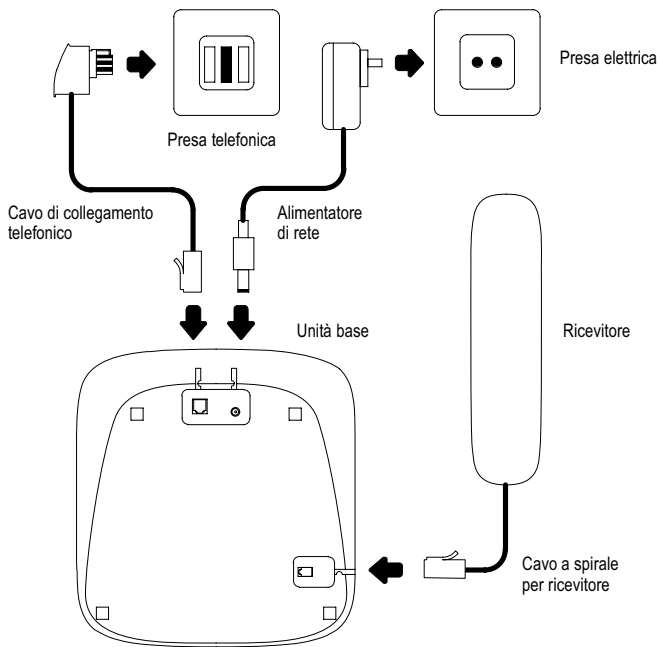

Utilizzare per l'unità base l'alimentatore di rete con dati di output 100-240 Vac 6 Vdc 500 mA.

Collegare la stazione di carica

Collegare la stazione di carica ad una presa elettrica.

Messa in funzione

Inserire le batterie ricaricabili nell'unità portatile

Il vano batterie si trova sul retro dell'unità portatile. Aprire il vano batterie e inserire 2 batterie ricaricabili tipo AAA NiMH, 1.2 V 500 mAh. Osservare la corretta polarità! Chiudere quindi il vano batterie.

Caricare le batterie



Riporre l'unità portatile in sede di prima messa in funzione per **minimo** 8 ore nella stazione di carica.

Un segnale acustico indica il corretto posizionamento dell'unità portatile nella stazione di carica. L'unità portatile si surriscalda durante il processo di carica. Questo è un fenomeno normale e non pericoloso. Evitare di caricare l'unità portatile con dispositivi di carica differenti o estranei. L'attuale **stato di carica delle batterie** è visualizzato sul display:



Carico



Scarico

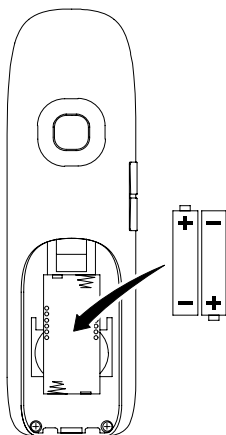

Impostare la lingua di display

Selezionare la lingua richiesta. Alle pagine 118 e 120 si trova la posizione da scorrere nel menu.

UP: > Imp. Ricev. > Lingua >...

UB: > Impost.base > Lingua >...

È possibile scegliere tra 9 lingue: tedesco, francese, italiano, inglese, spagnolo, portoghese, olandese, polacco e turco.

Impostare la data e l'ora

Data e ora si lasciano impostare tramite menu (Imposta ora) pagina 117.

Confermare l'immissione di anno, mese, giorno, ora e minuto rispettivamente con il tasto o . Osservare per ora e data il formato impostato pagina 117. Con formato 12 ore, selezionare con i tasti / se l'ora impostata è intesa come ora antimeridiana (A) o pomeridiana (P).

Impianti telefonici interni

A pagina 142 sono riportate ulteriori informazioni riguardo l'eventuale collegamento del telefono ad un impianto telefonico interno.

Riduzione delle radiazioni (modalità ECO)





Le radiazioni in modalità di stand-by sono state considerevolmente ridotte se paragonate a quelle emesse da telefoni cordless a standard DECT con unità portatile inserita nella stazione di carica. In modalità di conversazione le radiazioni sono ridotte in relazione alla distanza dell'unità portatile dal telefono (dall'unità base).



3 Elementi di comando

I tasti riportati nelle presenti istruzioni per l'uso sono raffigurati come simboli racchiusi in un riquadro. Sono possibili lievi scostamenti dei simboli dei tasti sul telefono rispetto ai simboli qui raffigurati.

Unità base

- | | | | |
|----|---|----|---|
| 1 | Ricevitore | 11 | Tasto avanti  |
| 2 | Tasto OK/Menu  | 12 | Segnalazione ottica di chiamata (LED di chiamata) |
| 3 | Display | 13 | Microfono |
| 4 | Tasto indietro  | 14 | Tasto vivavoce  |
| 5 | Tasti di selezione diretta M1 M2 | 15 | Tasto cancelletto  |
| 6 | Tasto On/Off segreteria  | 16 | Tasto R/Cancella  |
| 7 | Tasto su, elenco chiamate  | 17 | Tasto ripetizione di chiamata  |
| 8 | Tasto riproduzione/stop  | 18 | Tasto INT  |
| 9 | Tasto giù, rubrica telefonica  | 19 | Tasto asterisco  |
| 10 | Tasto indietro  | 20 | Tasti numerici 1, 2, 3 ecc. |

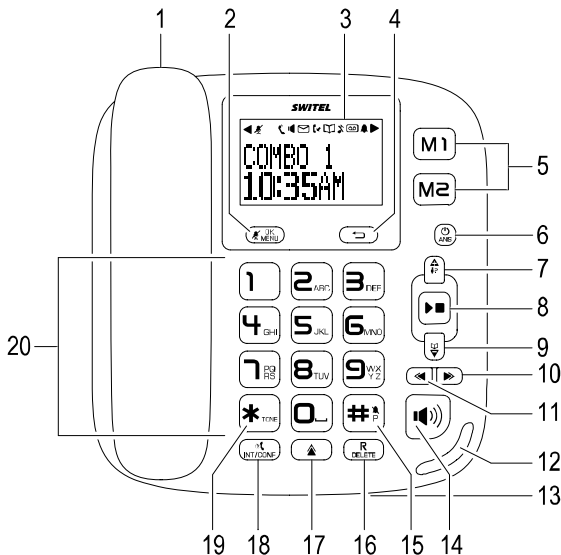

Elementi di comando





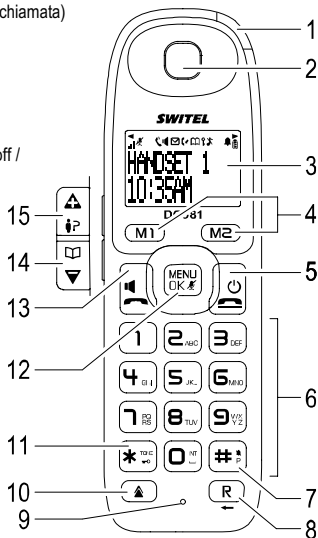









Unità portatile

- 1 Segnalazione ottica di chiamata (LED di chiamata)
- 2 Ricevitore
- 3 Display LC
- 4 Tasti di selezione diretta (M1) (M2)
- 5 Tasto riaggancio / On / Off
- 6 Tasti numerici (1) (2) ... (0)
- 7 Tasto cancelletto / Segnale di chiamata off / Pausa di selezione (**)
- 8 Tasto R / Indietro (R)
- 9 Microfono
- 10 Ripetizione di chiamata (▲)
- 11 Tasto asterisco (*)
- 12 Tasto Menu / OK / Silenziamento (MENU OK #)
- 13 Tasto conversazione / Vivavoce (☎)
- 14 Tasto freccia giù / Rubrica telefonica (☺)
- 15 Tasto freccia su / Elenco chiamate (▲)



Elementi di comando

Simboli e testi di display









Simbolo	Descrizione
	Indicazione dello stato di carica delle batterie (cariche, cariche a metà, quasi scariche). Scariche: caricare le batterie. Segmenti che scorrono: le batterie sono in fase di ricarica ➤ pagina 108. Segmenti visualizzati in modo costante: le batterie ricaricabili sono completamente cariche.
	Collegamento con l'unità base. Lampeggiante: collegamento scarso o assente. Costante: collegamento buono.
	Lampeggiante: chiamata in arrivo ➤ pagina 121. Costante: chiamata in corso ➤ pagina 121.
	Chiamate perse. Presenza di nuove chiamate nell'elenco chiamate ➤ pagina 129.
	Si è nella rubrica telefonica ➤ pagina 125.
	La voce o indicazione continua ulteriormente a destra ➤ pagina 126.
	La voce o indicazione continua ulteriormente a sinistra ➤ pagina 126.
	Costante: segreteria telefonica inserita ➤ pagina 133. Lampeggiante: presenza di nuovi messaggi in segreteria ➤ pagina 135. Oppure: la capacità di memoria della segreteria è esaurita. Cancellare dei messaggi ➤ pagina 136
	Il segnale di chiamata è disattivato ➤ pagina 124.
	Microfono in modalità silenziamento ➤ pagina 125.
	Funzione vivavoce attivata ➤ pagina 125.
	Blocco tastiera attivato ➤ pagina 121.
	Sveglia attivata ➤ pagina 131.
	Segreteria telefonica integrata nella rete telefonica. VMWI - Servizio addizionale del proprio gestore di rete ➤ pagina 143.

Informazioni introduttive

4 Informazioni introduttive

Il capitolo informa sulle modalità d'uso del presente manuale.

Modi di rappresentazione nelle istruzioni per l'uso

Rappresentazione	Descrizione
	Rappresentazione dei tasti
	Premere brevemente il tasto raffigurato
	Premere brevemente un tasto a piacere
2 sec. * →	Premere il tasto raffigurato per 2 secondi
	Immettere cifre o lettere
	Unità portatile squilla
	Telefono squilla
	Sollevarlo il ricevitore o estrarre il portatile dalla stazione di carica
	Riagganciare il ricevitore o riporre il portatile nella stazione di carica
Lingua	Rappresentazione di testi sul display
	Rappresentazione di simboli sul display
UP1, UP2	Unità portatile 1, unità portatile 2 ecc.
UB	Unità base

Modalità di stand-by

Nella descrizione d'uso si considerano sempre il telefono (unità base) e l'unità portatile in modalità di stand-by. Telefono (unità base) e unità portatile sono in modalità di stand-by quando non si conduce alcuna conversazione e tutti i menu sono chiusi.

Navigare nel menu

I vari menu consentono di accedere alle funzioni del telefono. Il percorso da seguire per giungere alla funzione desiderata è indicato dalla struttura di menu  pagina 114.



Ogni processo viene automaticamente interrotto se entro 20 secondi non si procede con una immissione.



Aprire il menu principale



Selezionare il sottomenu richiesto

¹ I tasti numerici riportano altresì delle lettere. Premendo ripetutamente il relativo tasto si ha modo di selezionare lettere, cifre e caratteri speciali.

Informazioni introduttive

	Aprire il sottomenu
/	Selezionare la funzione richiesta
	Aprire la funzione
/	Selezionare l'impostazione richiesta
	Immettere cifre o lettere attraverso il tastierino
	Confermare le immissioni
	Tornare indietro di un livello
	Interrompere le procedure di programmazione e memorizzazione e tornare indietro alla modalità di stand-by



Molte immissioni concluse con il tasto sono ulteriormente confermate da un segnale acustico.

Creare voci in rubrica - Esempio

La navigazione nei menu e la procedura da seguire per compiere impostazioni è indicata a titolo esemplificativo in **Creare voci di rubrica** (unità portatile). Si consiglia di seguire quanto riportato nell'esempio per tutte le impostazioni richieste.

	Aprire il menu principale
/ Rubrica	Aprire la rubrica telefonica
Aggiungi	Selezionare il sottomenu e confermare
Inser. nome	Immettere un nome (max. 12 segni) e confermare
Numero	Immettere il numero di chiamata 1 (numero cellulare) (max. 24 cifre) e confermare
Numero	Immettere il numero di chiamata 2 (numero fisso) (max. 24 cifre) e confermare
Suon.VIP , /	Assegnare uno squillo
	Tornare indietro alla modalità di stand-by



Per ogni nome o voce è possibile memorizzare 2 numeri telefonici. Il primo spazio memoria è preceduto dal simbolo di un cellulare, il secondo spazio memoria dal simbolo di una casa. Si consiglia pertanto di programmare per il primo spazio memoria un numero di cellulare, per il secondo spazio memoria un numero di rete fissa.

Struttura di menu

5 Struttura di menu

Per passare al menu principale, premere il tasto  o . Selezionare quindi con i tasti  /  una voce e confermare la selezione con il tasto  o . Maggiori informazioni su menu ed esercizio  capitolo 4.

Segr.telef

Mod. Resp.	Risp. e Reg.
	Solo risp.
	Off
Elim tut.vec	
Reg. memo	
Msg in usc.1	Esegui OGM
	Elim. MSG
	Registr. OGM
Msg in usc.2	Esegui OGM
	Elim. MSG
	Registr. OGM
Scher.chiam	On / Off
Rit.suon.	Salva gett.
	08 Squilli
	06 Squilli
	04 Squilli
	02 Squilli

Struttura di menu

Lungh ICM	180 Sec
	150 Sec
	120 Sec
	90 Sec
Voce ling	DEUTSCH
	FRANÇAIS
	NEDERLANDS
	ITALIANO
PIN remoto	

Intercom



Cuffie 01 - 06 ¹

¹ Visualizzazione in base al numero di unità portatili registrate



Struttura di menu

Rubrica

Aggiungi

Inser. nome	 ¹
Numero	
Numero	
Suon.VIP	01 / 02 / ... / Off

Modifica

Inser. nome	 ¹
Numero	
Numero	
Suon.VIP	01 / 02 / ... / Off

Elimina

Elim. tutto

Copia su

M1

M2

USO

¹ I tasti numerici riportano altresì delle lettere. Premendo ripetutamente il relativo tasto si ha modo di selezionare lettere, cifre e caratteri speciali.

Orolog/Svegl

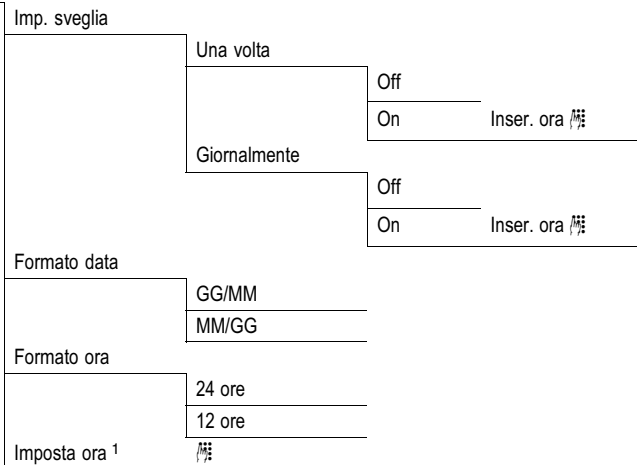



¹ La voce di menu consente di impostare data e ora.

Struttura di menu

Disponibile solo su un'unità portatile:

Imp. Ricev. ¹

Suono Ricev	
Volume Suon.	05 / ... / 01 / Off
Suon. est.	12 / ... / 01
Suon. inter	12 / ... / 01
Tono tasti	Off / Tono / Tono suon.
Batt scarica	On / Off
Fuori portat	On / Off
Equalizzat.	
Naturale	
Bassi	
Acuti	
Contrast.LCD	06 / ... / 01
Nome ricev.  ²	
Auto risp.	On / Off
Chiam.bamb.	
Off	
On	Inser.Numeri 
Bloc.tas.aut	On / Off
Lingua	(9 lingue)

¹ La voce di menu è visualizzata solo sull'unità portatile.

² I tasti numerici riportano altresì delle lettere. Premendo ripetutamente il relativo tasto si ha modo di selezionare lettere, cifre e caratteri speciali.

Struttura di menu

Disponibile solo su un'unità portatile:

Impost.base ¹

Canc. VMWI

Registra

Base PIN?2

Base PIN?2

Base PIN?2

Base PIN?2

Selez.base

Base

Base

Base

Base

Auto

Avanzato

Mod.composiz Toni / Impulsi

Tempo flash Breve / Medio / Lungo

Prefisso 

Filtro Chiam 04 / ... / 01 
Inser.Numeri 

Numero SOS 04 / ... / 01 
Inser.Numeri 

Canc.registr Cuffie

Cambia Pin PIN?

Reimposta Confermi?





¹ La voce di menu è visualizzata solo sull'unità portatile con esattamente gli stessi sottomenu.

² La configurazione iniziale del PIN corrisponde a "0000".

Struttura di menu

Disponibile solo sull'unità base:

Impost.base¹

Suoneria	
Volume Suon.	05 / ... / 01 / Off
Suon. est.	12 / ... / 01
Suon. inter	12 / ... / 01
Tono tasti	Off / Tono / Tono suon.
Contrast.LCD	06 / ... / 01
Canc. VMWI	06 / ... / 01
Lingua	(9 lingue)
Registra	
Base	PIN?2
Base	PIN?2
Base	PIN?2
Base	PIN?2
Avanzato	
Mod.composiz	Toni / Impulsi
Tempo flash	Breve / Medio / Lungo
Prefisso	
Filtro Chiam	04 / ... / 01  Inser.Numeri 
Numero SOS	04 / ... / 01  Inser.Numeri 
Canc.registr	Cuffie
Cambia Pin	PIN?
Reimposta	Confermi?

¹ La voce di menu è visualizzata solo sull'unità base con esattamente gli stessi sottomenu.

² Il codice PIN è impostato in fabbrica su "0000".

6 Funzionamento

Numerose funzioni sono comandabili sia tramite unità base sia tramite unità portatile. Si tenga presente che alcuni dei tasti raffigurati qui di seguito sono presenti sia sull'unità base sia sull'unità portatile ➤ pagina 109.



Con immissione in corso non è possibile passare dall'unità base all'unità portatile e viceversa. È pertanto indispensabile definire all'inizio della sequenza di comandi, se si intende utilizzare l'unità base oppure l'unità portatile.

Accendere e spegnere l'unità portatile

Con unità portatile disinserita non è possibile ricevere chiamate sull'unità portatile.

L'unità portatile spenta non consuma batterie.



Con unità portatile spenta non è però neanche possibile svolgere delle chiamate d'emergenza. Prima di poter fare ciò è indispensabile inserire l'unità portatile, cosa che può richiedere del tempo.

2 sec.

Accendere l'unità portatile (in modalità di stand-by)

2 sec.

Spegnere l'unità portatile

Blocco dei tasti

Il blocco dei tasti impedisce l'attivazione inavvertita di determinate funzioni.

1 sec.

Attivare il blocco dei tasti



L'attivazione del blocco dei tasti consente di ricevere telefonate in arrivo come di consueto. Con blocco dei tasti attivato è possibile svolgere delle chiamate d'emergenza (tramite i numeri di chiamata d'emergenza).

1 sec.

Disattivare il blocco dei tasti

Con blocco dei tasti attivato, sul display compare il simbolo

Il telefono può essere impostato in modo da attivare il blocco dei tasti automaticamente dopo 90 secondi ➤ pagina 131.

Telefonare

Ricevere una chiamata

Oltre allo squillo, ogni telefonata è altresì segnalata da una segnalazione ottica di chiamata.

), oppure

Accettare la chiamata



Non avvicinare l'unità portatile che squilla troppo all'orecchio visto il pericolo di danni all'udito!

Con ricezione automatica delle chiamate attivata, per accettare la chiamata è sufficiente estrarre l'unità portatile dalla stazione di carica ➤ pagina 131.

Concludere la chiamata





oppure



Concludere la chiamata

Per concludere una chiamata è anche possibile riporre l'unità portatile nella stazione di carica.

Funzionamento







Compiere telefonate

	Immettere un numero di chiamata (max. 48 cifre)
	In caso di immissione errata, cancellare l'ultima cifra
 oppure  oppure 	Selezionare il numero di chiamata

 È altresì possibile premere prima il tasto  sull'unità portatile o sollevare il ricevitore sull'unità base o premere il tasto  e ottenere un segnale di linea libera. Il telefono seleziona immediatamente le cifre immesse per la composizione del numero di chiamata desiderato (max. 48 cifre). Nel corso di una simile chiamata non è possibile eseguire la correzione di singole cifre che compongono il numero di chiamata.

Ripetizione di chiamata

Il telefono memorizza gli ultimi 5 numeri di chiamata selezionati assieme alla data e all'ora della telefonata. Per riselectare questo numero telefonico, ad es. perché la linea è risultata precedentemente occupata o perché non si è raggiunto nessuno, è possibile utilizzare la funzione ripetizione di chiamata:

 ,  / 	Aprire l'elenco di ripetizione di chiamata e selezionare una voce
 oppure  oppure 	Instaurare un collegamento

Il numero telefonico memorizzato è selezionato automaticamente instaurando un collegamento.

Richiamare una chiamata persa

Il telefono memorizza 40 numeri telefonici in un elenco chiamate.

 ,  / 	Aprire l'elenco chiamate e selezionare una voce
 oppure  oppure 	Instaurare un collegamento

Selezionare numeri telefonici dalla rubrica



Per fare questo è necessario aver precedentemente memorizzato dei numeri nella rubrica telefonica  pagina 126.

 ,  / 	Aprire la rubrica e selezionare una voce
 oppure  oppure 	Instaurare un collegamento

 Per poter accedere più velocemente ad una voce in rubrica, premere con rubrica aperta la lettera iniziale della voce richiesta. Sul display compare la prima voce con la lettera indicata.

Selezionare numeri telefonici tramite tasti di selezione diretta

La funzione prevede la precedente memorizzazione di numeri telefonici sui tasti di selezione diretta  pagina 127.













 oppure 	Instaurare un collegamento
--	----------------------------

Il numero di chiamata memorizzato è selezionato automaticamente.

Compiere chiamate interne

Per poter compiere telefonate interne gratuite è indispensabile aver registrato minimo un'unità portatile all'unità base.

Compiere chiamate interne

UP1:  oppure UB: 	
 /  Intercom ,  oppure 	Avviare la chiamata interna
UP1/UB:  /  ,  oppure 	Selezionare il portatile o la base richiesti
UP2: 	Accettare una telefonata interna presso l'altra unità portatile
UP1/UB / UP2: 	Concludere la chiamata interna



In caso l'unità portatile che si intende chiamare stia svolgendo una telefonata, nella linea si avverte un segnale acustico e sul display compare Linea occup. .

Accettare una chiamata esterna con telefonata interna in corso















In caso di arrivo di una telefonata esterna durante lo svolgimento di una chiamata interna, sul display viene visualizzato un messaggio.



















Accettare una chiamata esterna

Per concludere la chiamata interna sul portatile che ha accettato la telefonata esterna, premere il tasto .

Trasferire internamente chiamate interne









UP1:  oppure UB: 	
 /  Intercom ,  oppure 	Con chiamata esterna in corso
 /  ,  oppure 	Selezionare l'unità portatile o l'unità base richiesti
UP2: 	Accettare una telefonata interna presso l'altra unità portatile
UP1:  oppure UB: 	Inoltare la chiamata (riagganciare)

Riscontro / Chiamata in attesa

UP1:  oppure UB: 	
 /  Intercom ,  oppure 	Con chiamata esterna in corso
 /  ,  oppure 	Selezionare l'unità portatile o l'unità base richiesti
UP2: 	Accettare una telefonata interna presso l'altra unità portatile
UP1:  oppure UB:  ,  /  Alternare	
 oppure 	Cambiare il partner di chiamata

Condurre chiamate in conferenza

Questa funzione consente di condurre una conferenza con una chiamata esterna e un ulteriore interlocutore interno.

UP1:  oppure UB: 	
 /  Intercom , 	Con chiamata esterna in corso
 /  , 	Selezionare l'unità portatile o l'unità base richiesti

Funzionamento

UP2:  Accettare una telefonata interna presso l'altra unità portatile

UP1 o UB: 2 sec.  Conferenza Avviare una chiamata in conferenza



UP1 o UB e UP2:  Concludere la conferenza

Visualizzare la durata di conversazione

Trascorsi alcuni secondi dall'inizio di una conversazione, sul display viene visualizzata la durata di conversazione attuale in minuti e secondi.

Impostare il volume del ricevitore

Anche con chiamata in corso è possibile regolare il volume del ricevitore in 5 livelli.

 /  Aumentare/Ridurre il volume del ricevitore

Volume dello squillo di chiamata

Il volume dello squillo di chiamata può essere impostato in 5 livelli separatamente sia per l'unità portatile sia per l'unità base.



Impostare il volume di squillo dell'unità portatile

 Aprire il menu

 /  Imp. Ricev.  Selezionare Imp. Ricev.

 /  Suono Ricev  Selezionare Suono Ricev

 /  Volume Suon.  Selezionare Volume Suon.

 /  Aumentare/Ridurre il volume dello squillo di chiamata

 Salvare le impostazioni

Impostare il volume di squillo dell'unità base

 Aprire il menu

 /  Impost.base  Selezionare Impost.base

 /  Suoneria  Selezionare Suoneria

 /  Volume Suon.  Selezionare Volume Suon.

 /  Aumentare/Ridurre il volume dello squillo di chiamata

 Salvare le impostazioni

Disattivare e attivare lo squillo di chiamata

3 sec.  Disattivare lo squillo di chiamata





3 sec.  Attivare lo squillo di chiamata

Con squillo di chiamata disattivato, sul display compare il simbolo .

Lo squillo di chiamata si lascia disattivare tramite menu.

Funzione vivavoce



Utilizzare questa funzione per ascoltare il partner di chiamata attraverso l'altoparlante.



 ovvero 	Con chiamata in corso: attivare la funzione vivavoce
 ovvero 	Con chiamata in corso: disattivare la funzione vivavoce

Con funzione vivavoce attivata, sul display compare il simbolo .

Silenziamento del microfono

Con chiamata in corso è possibile attivare o disattivare il microfono dell'unità portatile o dell'unità base, di modo che l'interlocutore non vi senta in caso di consultazione di un'altra persona presente nella stessa stanza.

2 sec.  ovvero 	Con chiamata in corso: disattivare il microfono (silenziamento)
---	---

2 sec.  ovvero 	Con chiamata in corso: attivare il microfono
---	--

Con microfono muto, sul display compare il simbolo .

Rubrica telefonica

Nella rubrica telefonica è possibile memorizzare 50 interlocutori con ciascuno 2 numeri telefonici.





- Assegnare a tutti i numeri di chiamata sempre un prefisso in modo da poter riconoscere anche una chiamata urbana in arrivo ed abbinarla ad una voce presente nella rubrica telefonica.
- Con capacità di memoria esaurita, sul display compare l'indicazione **Mem piena** dopo aver memorizzato l'ultimo messaggio. Per poter disporre di nuovo spazio memoria, cancellare prima una voce già presente.
- Le voci della rubrica telefonica sono elencate in ordine alfabetico.

Se ci si trova nella rubrica telefonica, sul display compare il simbolo .

La segreteria telefonica è accessibile sia dall'unità base sia dall'unità portatile.

Inserire nomi

I tasti numerici riportano altresì delle lettere. Premendo ripetutamente il relativo tasto si ha modo di selezionare lettere, cifre e caratteri speciali.

	Immettere spazi vuoti
	Immettere caratteri speciali
	Cancellare
	Spostare il cursore





















Per immettere la stessa lettera una seconda volta, premere il rispettivo tasto. Attendere finché il cursore si sposta di una posizione. Immettere quindi la lettera una seconda volta.

Funzionamento

Creare voci in rubrica

☰ anche pagina 113

	Aprire la rubrica telefonica
 ovvero  Aggiungi	
 ovvero 	Selezionare il sottomenu e confermare
Inser. nome   ovvero 	Immettere il nome (max. 12 lettere) e confermare
Numero   ovvero 	Immettere il numero telefonico 1 (numero cellulare) (max. 24 cifre) e confermare
Numero   ovvero 	Immettere il numero telefonico 2 (numero fisso) (max. 24 cifre) e confermare
Suon.VIP ,  /   ovvero 	Assegnare uno squillo























Se le voci sono più lunghe dello spazio di display disponibile, sul display sono visualizzati i simboli ◀ e ▶. In questo modo si viene informati che la voce continua oltre il display a sinistra o a destra.

Con capacità di memoria esaurita, sul display compare l'indicazione **Mem piena** dopo aver memorizzato l'ultimo messaggio. Per poter disporre di nuovo spazio memoria, cancellare prima una voce già presente.

Se il nome immesso è già presente in rubrica, sul display compare l'indicazione









Doppio nome .

Modificare voci in rubrica

	Aprire la rubrica telefonica
 /   ovvero 	Selezionare la voce e confermare
 /  Modifica  ovvero 	Selezionare il sottomenu e confermare
Inser. nome   ovvero 	Modificare il nome (max. 12 cifre) e confermare
Numero   ovvero 	Modificare il numero telefonico 1 (numero cellulare) (max. 24 cifre) e confermare
Numero   ovvero 	Modificare il numero telefonico 2 (numero fisso) (max. 24 cifre) e confermare
Suon.VIP ,  /   ovvero 	Assegnare uno squillo

Cancellare voci in rubrica











Cancellare una voce

	Aprire la rubrica telefonica
 /  ,  oppure 	Selezionare la voce e confermare
 /  , Elimina  oppure 	Selezionare il sottomenu e confermare









Per poter accedere più velocemente ad una voce in rubrica, premere con rubrica aperta la lettera iniziale della voce richiesta. Sul display compare la prima voce con la lettera indicata.

Cancellare tutte le voci

	Aprire la rubrica telefonica
 oppure 	Aprire il menu
 /  , Elim. tutto  oppure 	Selezionare il sottomenu e confermare
Confermi?  oppure 	
Vuoto	Confermare la procedura di cancellazione
oppure	
Confermi?  oppure 	Interrompere la procedura di cancellazione















Verificare la memoria di rubrica

Il dispositivo visualizza il numero di posizioni di memoria libere dei 50 posti disponibili.

	Aprire la rubrica telefonica
 oppure 	Aprire il menu
 /  , USO  oppure 	Selezionare il sottomenu e confermare

Programmare i tasti di selezione diretta

2 numeri telefonici presenti in rubrica possono essere programmati in modo da venire selezionati premendo semplicemente il tasto **M1** oppure **M2** (selezione diretta).

	Aprire la rubrica telefonica
 /  ,  oppure 	Selezionare la voce e confermare
 /  , Copia su  oppure 	Selezionare il sottomenu e confermare
M1  /  ,  oppure 	Selezionare il tasto di selezione diretta e confermare
 oppure 	Confermare il numero telefonico visualizzato

Selezionare numeri telefonici tramite tasti di selezione diretta



















☞ pagina 122

Funzionamento

Elenco di ripetizione di chiamata

Il telefono memorizza gli ultimi 5 numeri di chiamata selezionati assieme alla data e all'ora della telefonata.











Memorizzare in rubrica un numero dall'elenco di ripetizione di chiamata

	Aprire l'elenco di ripetizione di chiamata
 /  ,  <small>ovvero</small> 	Selezionare la voce e confermare
 /  , Salva numero 	Selezionare il sottomenu e confermare
<small>ovvero</small> 	
Inser. nome   <small>ovvero</small> 	Immettere il nome (max. 12 lettere) e confermare
Inser. Numeri   <small>ovvero</small> 	Modificare se occorre il numero telefonico (max. 24 cifre) e confermare
 /  ,  <small>ovvero</small> 	Definire se si tratta di un numero cellulare o di un numero fisso e confermare

Cancellare un numero dall'elenco di ripetizione di chiamata

	Aprire l'elenco di ripetizione di chiamata
 /  ,  <small>ovvero</small> 	Selezionare la voce e confermare
 /  , Elimina  <small>ovvero</small> 	Selezionare il sottomenu e confermare

Cancellare tutto l'elenco di ripetizione di chiamata

	Aprire l'elenco di ripetizione di chiamata
 <small>ovvero</small> 	Aprire il menu
 /  , Elim. tutto  <small>ovvero</small> 	Selezionare il sottomenu e confermare
Confermi?  <small>ovvero</small> 	
Vuoto	Confermare la procedura di cancellazione
<small>oppure</small>	
Confermi?  , R <small>ovvero</small> 	Interrompere la procedura di cancellazione

Selezionare un numero dall'elenco di ripetizione di chiamata

 pagina 122

Elenco chiamate

In caso di assenza tutte le chiamate giunte sono memorizzate in un apposito elenco chiamate. In tutto è possibile memorizzare fino a 40 numeri di chiamata. Con ogni numero telefonico sono altresì memorizzate data e ora della chiamata.

Se ci si trova nell'elenco chiamate, sul display compare il simbolo .

Nell'elenco chiamate, l'ultimo numero perso è indicato come primo numero in lista.

In presenza di chiamate perse, la segnalazione ottica di chiamata lampeggia e sul display compare il simbolo . Sul display risulta in più anche un'indicazione relativa al numero di chiamate perse, perlomeno fintanto che non si apre la prima volta l'elenco chiamate.

Visualizzare numeri dall'elenco chiamate

 ,  /  Aprire l'elenco chiamate e selezionare una voce

Memorizzare in rubrica un numero dall'elenco chiamate



È possibile memorizzare un numero di chiamata direttamente dall'elenco chiamate nella rubrica telefonica.





 ,  /  Aprire l'elenco chiamate e selezionare una voce

 MENU / OK #  ovvero  Aprire il menu

 /  **Salva numero** ,  MENU / OK #
ovvero  Selezionare il sottomenu e confermare



Inser. nome  MENU / OK # ovvero  Immettere il nome (max. 12 lettere) e confermare

Inser. Numeri  MENU / OK # ovvero  Modificare se occorre il numero telefonico (max. 24 cifre) e confermare

 /  ,  MENU / OK # ovvero  Definire se si tratta di un numero cellulare o di un numero di telefono fisso e confermare

Cancellare numeri dall'elenco chiamate

Cancellare singoli numeri di chiamata

 ,  /  Aprire l'elenco chiamate e selezionare una voce

 MENU / OK #  Aprire il menu



 /  **Elimina** ,  MENU / OK # ovvero  Selezionare il sottomenu e confermare

Cancellare tutti i numeri di chiamata

 Aprire l'elenco chiamate

 MENU / OK #  Aprire il menu

 /  , **Elim. tutto**  MENU / OK # ovvero  Selezionare il sottomenu e confermare

Confermi? ,  MENU / OK # ovvero  **Vuoto** Confermare la procedura di cancellazione

oppure

Confermi? ,  R oppure  Interrompere la procedura di cancellazione

Funzionamento

Richiamare chiamate ricevute

☞ pagina 122

Impostare toni e indicazioni

Varie opzioni di impostazione consentono di adattare il telefono alle proprie esigenze:

Impostare lo squillo di chiamata

Si prega di definire uno squillo per chiamate esterne e interne. In tutto è possibile scegliere tra 12 squilli polifonici.

Impostare lo squillo di chiamata ☞ Menu pagina 118

Suono dei tasti

I suoni dei tasti danno conferma di aver effettivamente premuto il tasto interessato. Il telefono si lascia impostare in modo che premendo un qualsiasi tasto si avverta sempre lo stesso tono (impostazione Tono), oppure toni sempre diversi (impostazione Suoneria). In più è anche possibile disattivare il suono dei tasti.

Impostare il suono dei tasti ☞ Menu pagina 118

Suono di avviso del livello di carica delle batterie

Un segnale acustico informa sul basso livello di carica delle batterie.

Impostare il segnale acustico del livello di carica delle batterie (Batt scarica) ☞ Menu pagina 118

Suono di avviso di portata

Un segnale acustico informa che l'unità portatile si trova fuori della portata dell'unità base.

Impostare il segnale acustico di portata (Fuori portat) ☞ Menu pagina 118

Equalizzatore

La qualità del suono dell'altoparlante può essere adattata alle proprie esigenze. Lasciare il suono Naturale oppure mettere in evidenza i Bassi o gli Acuti.

Impostare l'equalizzatore ☞ Menu pagina 118

Contrasto di display

Il contrasto di display (Contrast.LCD) di unità base e unità portatile è regolabile in 6 livelli

☞ Menu pagine 118 e 120

Nome del portatile

All'unità portatile può essere assegnato un nome individuale (Nome ricev.) ☞ Menu pagina 118

Formato di ora e data

Il telefono consente di definire il formato e l'ordine di immissione riferiti a ora e data

☞ Menu pagina 117

Impostazioni varie

Ricezione automatica di chiamate

L'attivazione di questa funzione consente di ricevere automaticamente una chiamata estraendo semplicemente l'unità portatile dalla stazione di carica. L'accettazione di chiamata automatica è attivata o disattivata nel menu.

Attivare l'accettazione automatica di chiamate ➤ Menu pagina 118



La voce di menu Auto risp. può essere richiamata solo attraverso il menu dell'unità portatile.

Blocco dei tasti

Con impostazione attivata, il blocco dei tasti si attiva automaticamente se non si preme alcun tasto per 90 secondi. Con blocco dei tasti attivato, sul display compare il simbolo .

Attivare il blocco dei tasti ➤ Menu pagina 118

Prefisso

È possibile impostare un prefisso (Prefisso). Premendo a lungo il tasto 

prima o dopo l'immissione di un numero di chiamata, il prefisso andrà a precedere il numero interessato. Premendo il tasto  il numero di chiamata è selezionato.

Modificare il prefisso ➤ Menu pagina 119

Modificare il PIN

Il codice PIN è necessario alla registrazione di unità portatili. La configurazione iniziale del codice è "0000". Modificare il PIN ➤ Menu pagina 119 (menu dell'unità base)

Reset

La funzione consente di ripristinare la configurazione iniziale del telefono.

Reset ➤ Menu pagine 119 e 120

Cercare l'unità portatile (funzione di paging)

Avendo perso d'occhio la propria unità portatile è possibile ritrovarla facilmente grazie all'emissione di un tono di ricerca emesso dall'unità base.



Requisiti: l'unità portatile è inserita, si trova entro la portata dell'unità base, le batterie non sono scariche e lo squillo dell'unità portatile non risulta disattivato. Significa che sul display dell'unità portatile NON è consentito che risulti visualizzato il simbolo .

UB: 

Avviare la chiamata interna

UB:  / 

Selezionare l'unità portatile che si intende cercare

UB: 

Avviare la chiamata di paging

Funzioni speciali

Sveglia

Con la funzione è possibile farsi svegliare/rilasciare un allarme dalla propria unità portatile all'orario precedentemente impostato. Con sveglia attivata, sul display compare il simbolo . Una volta raggiunto l'orario di sveglia, il telefono emette lo squillo di chiamata per 1 minuto. Sul display compare l'indicazione Allarme.

Funzionamento

Impostare la sveglia

È possibile definire se utilizzare la sveglia per un solo giorno (Una volta) oppure se si vuole essere svegliati allo stesso orario più volte (Giornalmente).



Impostare la sveglia (Imp. sveglia). Menu pagina 117

Disattivare la sveglia anzitempo



Disattivare la sveglia

Funzione baby controllo

La funzione consente di memorizzare un determinato numero telefonico (max. 24 cifre) chiamato automaticamente attraverso il vivavoce non appena si aziona un qualsiasi tasto (tranne i tasti  e ).

Con funzione attivata, sul display lampeggia in modo permanente l'indicazione

Chiam.bamb.

Attivare il baby controllo  Menu pagina 118

Blocco di chiamata

Il blocco di chiamata impedisce di selezionare sull'unità portatile numeri telefonici che iniziano con le cifre predefinite. È prevista la memorizzazione di 4 numeri bloccabili composti da rispettivamente max. 8 cifre.

Attivare il blocco di chiamata  Menu pagina 119

Avendo selezionato un numero telefonico bloccato, il dispositivo non instaura alcun collegamento. Il dispositivo emette un segnale di avvertimento e torna alla modalità di stand-by.

Numero d'emergenza

È prevista la memorizzazione di fino a 4 numeri di chiamata selezionabili nonostante la precedente attivazione del blocco di chiamata. A pagina 119 è indicata la posizione da scorrere nel menu.

Procedura di selezione

L'unità portatile è utilizzabile sia in sistemi telefonici analogici (procedura di selezione a impulsi / IWV) sia se integrata in moderni sistemi telefonici digitali (procedura di selezione a toni / MFV). La procedura di selezione è impostata tramite menu. A pagina 119 è indicata la posizione da scorrere nel menu.



Utilizzando il telefono con modalità di selezione a impulsi, durante lo svolgimento di una chiamata è possibile premere il tasto  per passare alla modalità di selezione a toni per il resto della conversazione.

Visualizzare il numero di chiamata (CLIP)



La visualizzazione del numero di chiamata (CLIP) e la visualizzazione di data e ora sono servizi del proprio gestore di rete. Si consiglia di rivolgersi direttamente al proprio gestore di rete per ulteriori informazioni a riguardo.

Se il proprio impianto telefonico è abilitato alla funzione CLIP (CLIP = Calling Line Identification Presentation), il display visualizza in caso di chiamata in arrivo il numero di chiamata dell'interlocutore, qualora questi abbia acconsentito alla trasmissione del proprio numero telefonico.



Se non si accetta una chiamata, il display rimane illuminato per ca. 6 secondi, prima che vengano quindi di nuovo visualizzati data e ora attuali.

7 Segreteria telefonica

La segreteria telefonica memorizza fino a 57 messaggi (59 messaggi inclusi i messaggi di risposta). La durata di registrazione max. è di 15 minuti (inclusi i messaggi di risposta).

Non appena la capacità di memoria risulta esaurita non è più possibile registrare dei messaggi nuovi. La segreteria telefonica passa quindi automaticamente alla modalità di sola risposta.

La segreteria telefonica può essere comandata sia dall'unità base sia dall'unità portatile.

Attivare / Disattivare la segreteria

Con segreteria telefonica inserita, il tasto riproduzione / stop sull'unità base lampeggia di rosso. In più, sul display dell'unità base e sull'unità portatile registrata viene visualizzato in modo permanente il simbolo .



La configurazione iniziale prevede che la segreteria telefonica sia inserita.

Attivare/Disattivare la segreteria dall'unità base



Attivare/Disattivare la segreteria telefonica

Attivare la segreteria dall'unità portatile

 /  /  **Segr.telef** ,  /  /  **Mod. Resp.** , 
 /  **Risp. e Reg.** o **Solo risp.** 

 Menu pagina 114

Disattivare la segreteria dall'unità portatile

 /  /  **Segr.telef** ,  /  /  **Mod. Resp.** , 
 /  **Off** , 

 Menu pagina 114

Modalità di risposta

La segreteria telefonica prevede due modalità di risposta: la modalità di risposta e registrazione (Risp. e Reg.) e la modalità di sola risposta (Solo risp.). In modalità di risposta e registrazione è dato modo di lasciare un messaggio. In modalità di sola risposta non è invece possibile lasciare alcun messaggio.

Selezionare la modalità di risposta

Selezionare la modalità desiderata  Menu pagina 114. Vedi anche la sezione "Attivare/Disattivare la segreteria" a pagina 133.



La configurazione iniziale della segreteria telefonica prevede che sia inserita la modalità di risposta e registrazione.

Segreteria telefonica

Messaggio di risposta

La segreteria telefonica offre due messaggi di risposta preimpostati. Entrambi i messaggi di risposta possono essere sostituiti da messaggi individuali.

In modalità di risposta e registrazione, il messaggio di risposta utilizzato è **Msg in usc.1**, in modalità di solo annuncio il messaggio di risposta utilizzato è **Msg in usc.2**.



Una volta registrato il messaggio di risposta personale, questo viene subito utilizzato come messaggio di risposta.

Con memoria della segreteria telefonica piena, l'apparecchio riproduce automaticamente il messaggio di risposta della modalità di sola risposta.

Lingua dei messaggi di risposta

L'uscita vocale del messaggio di risposta standard della segreteria telefonica è modificabile. È possibile scegliere tra 4 lingue.

oppure / / **Segr.telef** ,

oppure / / **Voce ling** ,

oppure

Aprire il sottomenu

/ , oppure

Selezionare la lingua e confermare

Riprodurre il messaggio di risposta

Menu pagina 114 (Esegui OGM)

Registrare un messaggio di risposta personale

Un messaggio di risposta personale può avere una lunghezza max. di 2 minuti.

oppure / / **Segr.telef** ,

oppure

Selezionare il sottomenu

/ **Msg in usc.1**

o **Msg in usc.2** oppure

Selezionare il messaggio di risposta

/ / **Registr.OGM** ,

oppure

Procedere alla registrazione



Registrare il messaggio di risposta

oppure

Concludere e memorizzare la registrazione

L'annuncio che si desidera registrare va parlato in modo chiaro e forte nel microfono della propria unità base (sulla parte anteriore del dispositivo) o dell'unità portatile. Una volta conclusa, la risposta è ripetuta ad alta voce.



Per usufruire della funzione di interrogazione a distanza è importante registrare dei messaggi di risposta abbastanza lunghi (max. 2 minuti)

"Interrogazione a distanza" pagina 138.

Riattivare la risposta standard

Se si cancella il messaggio di risposta personale, si attiva automaticamente il messaggio di risposta standard.

Per cancellare un messaggio di risposta, navigare nel menu  Menu pagina 114 (Elim. MSG).



I messaggi di risposta standard non sono cancellabili.

Riprodurre messaggi registrati

In presenza di nuovi messaggi, sull'unità base e l'unità portatile registrata lampeggiano le indicazioni ottiche e sul rispettivo display, in più, il simbolo . Sul display dell'unità base e delle unità portatili registrate è anche visualizzato un'indicazione testuale relativa al numero di nuovi messaggi.

I messaggi ricevuti sono numerati nell'ordine in cui sono registrati.





I messaggi ricevuti sono quindi riprodotti in ordine inverso: il messaggio registrato per ultimo è riprodotto per primo.

Durante la riproduzione sono visualizzati la data e l'ora della registrazione.























Il dispositivo riproduce solo i messaggi nuovi. Per riprodurre i messaggi vecchi, avviare la riproduzione dei messaggi una seconda volta.

Riprodurre messaggi sull'unità base (tramite altoparlante)





	Riprodurre/Interrompere i messaggi
	Ripetere il messaggio
2x 	Messaggio precedente
	Messaggio successivo

Riprodurre messaggi sull'unità portatile

  /  Esegui msg 	
 Attesa	Riprodurre messaggi (tramite altoparlante)
Opzioni durante la riproduzione:	
	Aprire il menu
 /  Elim. MSG 	
Eliminato	Cancellare un messaggio
 /  Arresta 	Interrompere la riproduzione
 /  Inoltra MSG 	Messaggio successivo
 /  Ripeti MSG 	Riprodurre il messaggio attuale dall'inizio
 /  Riavv. MSG 	Messaggio precedente

Segreteria telefonica

In alternativa è possibile richiamare queste funzioni premendo una certa combinazione di tasti:



	Cancellare il messaggio
	Riprodurre il messaggio attuale dall'inizio
2x 	Messaggio precedente
	Interrompere la riproduzione (Pausa)
	Messaggio successivo

Impostare il volume per la riproduzione di messaggi

Con riproduzione in corso, sull'unità base è possibile impostare il volume in 5 livelli.

 /  Aumentare/Ridurre il volume

Con riproduzione in corso, sull'unità portatile è possibile impostare il volume attraverso 5 livelli.

 /  Aumentare/Ridurre il volume

Cancellare un messaggio

Durante la riproduzione di un messaggio:

UB:  Cancellare il messaggio

oppure

UP:  Aprire il menu

UP:  /  **Elim. MSG** 
 Cancellare un messaggio

oppure

UP:  Cancellare il messaggio

Cancellare tutti i messaggi

Tutti i vecchi messaggi sono cancellati.



Una volta cancellati i messaggi non sarà più possibile ripristinarli!



 oppure  /  **Elim tut.vec**,

 oppure  **Confermi?**  oppure 

Intercettazione



È possibile ascoltare chiamate in arrivo sull'unità base attraverso il diffusore acustico, senza bisogno di accettare la chiamata. Allo scopo è necessario attivare nel menu la funzione di intercettazione  Menu pagina 114 (Scher.chiam).



Per modificare il volume con intercettazione in corso, premere i tasti  e .

Accettare una chiamata

Anche se la segreteria telefonica ha già risposto ad una chiamata è comunque possibile riprendere la telefonata. La registrazione del messaggio viene in tal caso interrotta.

 oppure  oppure  Accettare la chiamata

Ritardo nell'accettazione di chiamata

Il menu consente di definire la frequenza con cui fare squillare il telefono prima di ascoltare un messaggio di risposta. È possibile scegliere tra 2, 4, 6 o 8 segnalazioni di chiamata ➤ Menu pagina 114 (Rit.suon.).



La configurazione iniziale prevede che la segreteria telefonica sia inserita squillando 4 volte.

In più è possibile servirsi della funzione **Salva gett.** per compiere interrogazioni a distanza/preliminari senza addebito di scatti. Con questa funzione di interrogazione a distanza/preliminare è possibile verificare gratuitamente la presenza di nuovi messaggi sulla propria segreteria telefonica. Se ci sono messaggi nuovi sulla segreteria telefonica, l'apparecchio accetta la telefonata dopo massimo 2 segnalazioni di chiamata. Se non ci sono messaggi nuovi sulla segreteria telefonica, l'apparecchio accetta la telefonata solo dopo 6 segnalazioni di chiamata. Riagganciare prima del 6° squillo. In tal modo si evita l'addebito di scatti telefonici.

Ulteriori informazioni sull'interrogazione a distanza ➤ pagina 138.

Durata di registrazione massima per messaggio



È possibile scegliere tra 4 durate di registrazione ➤ Menu pagina 115 (Lungh ICM)



Registrare un promemoria

Un promemoria è un messaggio che è possibile riprodurre e quindi ascoltare allo stesso modo di un messaggio ricevuto. Un promemoria può avere una lunghezza max. di 3 minuti ed è registrato sull'unità portatile.





I promemoria si possono registrare anche con segreteria telefonica disattivata.

 oppure  /  **Segr.telef** ,

 oppure 

Selezionare il sottomenu

 oppure  /  **Reg. memo** ,

 oppure 

Avviare la registrazione



Registrare un promemoria

 oppure 



Concludere e memorizzare la registrazione

Interrompere la registrazione del promemoria

UB: 

Interrompere la registrazione e tornare indietro al sottomenu

oppure

UP:  oppure 

Interrompere la registrazione e tornare indietro al sottomenu

Segreteria telefonica

Interrogazione a distanza

È dato modo di chiamare la propria segreteria telefonica per attivarla, ascoltare messaggi ricevuti e compiere una serie di funzioni accessorie. Requisito per questa operazione è un telefono abilitato alla selezione a toni.

Codice PIN per l'interrogazione a distanza

Il PIN remoto è impostato in fabbrica e corrisponde a "1234". Si consiglia di modificare il PIN remoto in modo da escludere l'accesso di persone non autorizzate alla propria segreteria telefonica. Modificare il codice PIN per l'interrogazione a distanza ☞ Menu pagina 115.



Se in seguito a modifica del codice PIN per l'interrogazione a distanza questo si dovesse dimenticare, consultare il menu relativo al codice PIN per l'interrogazione a distanza ☞ Menu pagina 119 (PIN remoto).

Avviare l'interrogazione a distanza

Sul telefono utilizzato per l'interrogazione a distanza deve risultare impostata la procedura di selezione a toni.



Selezionare da una linea telefonica esterna il proprio numero telefonico.



Con segreteria telefonica inserita, il messaggio di risposta è riprodotto dopo il numero di squilli precedentemente impostato.

Con segreteria telefonica disattivata, il telefono si inserisce automaticamente dopo il 10° squillo e si avverte un segnale acustico lungo.



Avviare l'interrogazione a distanza.

Fatto questo si avverte un segnale acustico lungo.



Con segreteria telefonica inserita, l'interrogazione a distanza va avviata mentre il dispositivo riproduce il messaggio di risposta previsto. Pertanto è importante che il messaggio di risposta risulti sufficientemente lungo.



Immettere il codice PIN a 4 cifre per l'interrogazione a distanza. Fatto questo si avverte un segnale acustico lungo.

A questo punto è dato modo di svolgere ulteriori funzioni

☞ Tabella delle funzioni a tasti dell'interrogazione a distanza a pagina 139.



Premere il tasto per eseguire la funzione richiesta.

Fatto questo si avverte un segnale acustico lungo.



È anche possibile eseguire più funzioni una dopo l'altra.

Concludere l'interrogazione a distanza



Concludere l'interrogazione a distanza

Segreteria telefonica

Funzioni a tasti dell'interrogazione a distanza

La seguente tabella offre una vista panoramica delle funzioni disponibili e dei tasti abbinati alle rispettive funzioni.

Tasto	Se non viene riprodotto <u>nessun</u> messaggio	Durante la riproduzione di messaggi
0		Cancellare un messaggio
1		Ripetere il messaggio
2	Riprodurre il messaggio, proseguire la riproduzione	Interrompere la riproduzione (Pausa)
3		Riprodurre il messaggio successivo
4	Attivare / Disattivare la segreteria telefonica	
5	Registrare un promemoria ¹	
*		Concludere la riproduzione

Attivare la segreteria tramite interrogazione a distanza



Selezionare da una linea telefonica esterna il proprio numero telefonico. Dopo il 10° squillo il telefono si inserisce automaticamente e si avverte un segnale acustico lungo.



Avviare l'interrogazione a distanza. Fatto questo si avverte un segnale acustico lungo.



Immettere il codice PIN a 4 cifre per l'interrogazione a distanza. Fatto questo si avverte un segnale acustico lungo.



Attivare la segreteria telefonica. Fatto questo si avverte un segnale acustico lungo. Il messaggio di risposta è riprodotto.



Riagganciare / Concludere il collegamento

¹ Concludere la registrazione di un promemoria in seguito a interruzione dell'interrogazione a distanza.

Ampliare il sistema telefonico

8 Ampliare il sistema telefonico

Lo standard internazionale **GAP**¹ regola la compatibilità di unità portatili e telefoni (stazioni base) di costruttori differenti. In tal modo è possibile adoperare apparecchi SWITEL in combinazione con apparecchi di altri costruttori all'interno di un unico sistema telefonico. Ciò nonostante può comunque anche verificarsi che determinate funzioni non siano disponibili.





Più unità portatili

L'unità base consente la registrazione di complessivamente 6 unità portatili.

Registrare unità portatili

Le unità portatili sono registrate tramite menu  Menu pagine 119 e120.





Sull'unità base:



 /  / , **Impost.base**,  Aprire il menu

 / , **Registra**, ,

Confermi?,  **In ricerca** Aprire il menu

Sull'unità portatile da registrare:

 /  / , **Impost.base**,  Aprire il menu

 / , **Registra**,

 **Base** ✕ Aprire il menu

 / , **Base** ✕,  Selezionare la base richiesta

PIN?   Immettere e confermare il PIN²



Premendo il tasto  è possibile cancellare le cifre immesse per errore.

L'unità portatile cerca l'unità base. Questa procedura può richiedere fino a 2 minuti.

Una volta eseguita la registrazione, all'unità portatile è assegnato un numero di chiamata interno. Questo numero di chiamata interno è visualizzato sul display.



Per registrare unità portatili di altri costruttori, leggere prima le rispettive istruzioni per l'uso.

¹ **GAP**: **Generic Access Profile** = Standard per l'interazione di unità portatili e stazioni base di altri costruttori.

² La configurazione iniziale del PIN corrisponde a "0000".

Ampliare il sistema telefonico

Annulare la registrazione di unità portatili



L'annullamento della registrazione di un'unità portatile è possibile solo dall'unità base o da un'altra unità portatile anch'essa registrata alla stessa unità base. L'unità portatile non può annullare la registrazione autonomamente.

Le unità portatili sono registrate tramite menu Menu pagine 119 e 120.

Sull'unità base:

/ / , Impost.base ,	Aprire il menu
/ , Avanzato ,	Aprire il menu
/ , Canc.registr ,	Aprire il menu
Cuffie 0x / ,	
Attesa	Selezionare l'unità portatile e avviare la procedura di annullamento della registrazione

Più stazioni base¹/Unità base²

La portata dell'unità portatile può essere aumentata registrando il dispositivo su più telefoni (stazioni base¹/unità base²). La registrazione è possibile su 4 telefoni (stazioni base¹/unità base²) differenti. Ogni telefono (ogni stazione base¹/unità base²) richiede una presa telefonico autonoma. Si può trattare di allacciamenti con lo stesso o differente numero di chiamata.



Chiamate in corso sono trasferibili da un telefono all'altro (da una stazione o unità base all'altra).

¹ La base del DC 58x è indicata come stazione base.

² La base del DCT 587x è indicata come unità base.

Impianti telefonici interni / Servizi aggiuntivi

9 Impianti telefonici interni / Servizi aggiuntivi

Tasto R e servizi aggiuntivi

Il telefono supporta servizi aggiuntivi offerti dal proprio gestore di rete telefonica come ad es. le funzioni di chiamata in attesa, avviso di chiamata e chiamata in conferenza. Il tasto **R** consente di accedere ai servizi aggiuntivi. Il proprio gestore di rete telefonica fornisce informazioni sul tempo flash necessario all'utilizzo dei servizi aggiuntivi e sui requisiti di abilitazione ai servizi aggiuntivi. Il tempo flash è impostato tramite menu **F** pagina 119.

Tasto R in impianti telefonici interni

Con telefono integrato in un impianto telefonico interno, premendo il tasto **R** è possibile usufruire di funzioni come ad es. inoltro di chiamate e richiamata automatica. Consultare le istruzioni per l'uso del proprio impianto telefonico interno per individuare il tempo flash richiesto. Il rivenditore autorizzato è in grado di indicare se il telefono acquistato funzionerà senza alcun problema nel proprio impianto telefonico interno. Il tempo flash è impostato tramite menu **F** pagina 119.

Codice di accesso (numero di accesso alla rete esterna)

In presenza di impianti telefonici interni è necessario preselezionare un numero di accesso alla rete esterna per ottenere un segnale di linea libera prima di compiere una telefonata. Spesso il numero di accesso alla rete esterna è uno "0" o un "9". Digitare prima il numero di accesso alla rete esterna, attendere il segnale di linea libera. A questo punto è possibile inserire il numero di chiamata vero e proprio.



Volendo utilizzare la funzione di selezione diretta anche in un impianto telefonico interno, tenere conto durante la programmazione dei tasti di selezione diretta del numero di accesso alla rete esterna che è necessario inserire prima del numero telefonico.

Tra numero di accesso alla rete e numero telefonico è altresì possibile prevedere una pausa di selezione **F** sezione "Pausa di selezione".

Pausa di selezione

In presenza di impianti telefonici interni è necessario preselezionare un numero di accesso alla rete esterna per ottenere un segnale di linea libera prima di compiere una telefonata. Alcuni impianti telefonici interni di vecchia data richiedono del tempo prima di trasmettere il segnale di linea libera. Per questi impianti telefonici interni è possibile inserire una pausa di selezione dopo il numero di accesso alla linea esterna in modo da poter proseguire con la selezione del numero senza dover attendere il segnale di libero. Per inserire la pausa di selezione, premere e tenere premuto per 3 sec. il tasto ****#**.

Dopo il numero di accesso alla rete esterna si procede, trascorso un determinato intervallo di tempo, con la selezione del numero di chiamata vero e proprio.



La pausa di selezione si può memorizzare anche durante l'immissione di numeri di chiamata nella rubrica telefonica.

Impianti telefonici interni / Servizi aggiuntivi

Visualizzare il numero di chiamata (CLIP¹)



La visualizzazione del numero di chiamata è un servizio aggiuntivo offerto dal proprio gestore di rete telefonica. Per informazioni rivolgersi al proprio gestore di rete telefonica.

A condizione che il collegamento telefonico disponga di questa funzione, l'apparecchio visualizza il numero telefonico del chiamante non appena il telefono squilla. Se il chiamante ha soppresso la trasmissione del proprio numero di chiamata, il telefono visualizza un'apposita indicazione. Se il numero di chiamata non è visualizzabile, questo non sarà memorizzato nell'elenco chiamate.

Segreteria integrata nella rete telefonica

Sono numerosi i gestori di rete telefonica che offrono come servizio aggiuntivo una segreteria telefonica integrata nella stessa rete. Se il gestore di rete telefonica mette a disposizione una segreteria telefonica all'interno della propria rete, un simbolo informa sulla presenza di nuovi messaggi (VMWI²). Questa funzione è disponibile solo nel caso di abilitazione al servizio da parte del gestore di rete telefonica. Per maggiori dettagli rivolgersi al proprio gestore di rete telefonica.

¹ **CLIP:** Calling Line Identification Presentation = Visualizzazione del numero telefonico del chiamante.

² **VMWI:** Visual Message Waiting Indication = Segnalazione ottica di nuovi messaggi.

Specifiche tecniche

10 Specifiche tecniche

Caratteristica	Valore
Standard	DECT ¹ -GAP ²
Alimentazione elettrica (unità base)	Ingresso: 100-240 V, 50-60 Hz Uscita: 6 V, 500 mA
Alimentazione elettrica (stazione di carica)	Ingresso: 100-240 V, 50-60 Hz Uscita: 6 V, 150 mA
Batterie ricaricabili	2 x 1.2 V 500 mAh NiMH, tipo: AAA
Portata dell'unità portatile	Esterno: ca. 300 m Interno: ca. 50 m
Autonomia di stand-by unità portatile	fino a 110 ore
Max. durata di conversazione unità portatile	fino a 11 ore
Max. volume ricevitore	30 dB
Procedura di selezione	Selezione a toni (MFV) Selezione a impulsi (IWW)
Tempo flash	breve, medio, lungo
Lingue di menu	Tedesco, francese, italiano, inglese, spagnolo, portoghese, olandese, polacco, turco
PIN (configurazione iniziale)	0000
Numero di squilli	12 (polifonici)
Max. numero di voci in rubrica	50
Max. numero di voci nell'elenco chiamate	40
Max. numero di voci per ripetizione di chiamata	5
Max. numero di messaggi in segreteria	57
Max. durata di registrazione in segreteria	15 min (inclusi i messaggi di annuncio)
Lingue delle risposte standard	Tedesco, francese, italiano, inglese
Codice PIN per interrogazione a distanza (configurazione iniziale)	1234

¹ DECT: Digital Enhanced Cordless Telecommunication = Standard per telefoni senza cavo

² GAP: Generic Access Profile = Standard per l'interazione di unità portatili e stazioni base di altri costruttori.

Dichiarazione di conformità

Questo apparecchio risponde a quanto disposto dalla Direttiva UE

1999/5/CE concernente le apparecchiature radio, le apparecchiature terminali di telecomunicazioni e il reciproco riconoscimento della loro conformità. La conformità con la direttiva di cui sopra viene confermata dal marchio CE applicato sull'apparecchio.



Linea diretta di assistenza

In presenza di problemi con il telefono, seguire le indicazioni riportate qui di seguito. In caso di problemi tecnici è possibile rivolgersi alla linea di assistenza chiamando al numero 0900 00 1675 valido per la Svizzera (spese da rete Swisscom alla data di stampa: 2.60 CHF/min). In caso di reclami entro il periodo di garanzia, rivolgersi al rivenditore autorizzato. Il periodo di garanzia ricopre 2 anni.

11 Problemi

Domande	Risposte
Non è possibile condurre una chiamata telefonica	<ul style="list-style-type: none"> - Il telefono ovvero l'unità base non è collegato correttamente oppure presenta un guasto. Utilizzare esclusivamente il cavo di collegamento telefonico fornito. - L'alimentatore di rete non è inserito oppure si è in presenza di una caduta di tensione totale. - Provare con un altro telefono se l'allacciamento telefonico in questione è funzionante. - Errata ubicazione dell'unità base. - Le batterie ricaricabili sono scariche o difettose. - La distanza dell'unità portatile dall'unità base è troppo grande. Per aumentare la portata è possibile registrare un'unità portatile a più unità base ➤ pagina 141. - Procedura di selezione impostata erratamente ➤ pagina 119 - Con più unità portatili registrate: chiamata in corso su un'altra unità portatile. - Con chiamate telefoniche interne: l'unità portatile chiamata è fuori della portata dell'unità base. - Il blocco tastiera è attivato. - L'unità portatile non è inserita.
Non è possibile instaurare un collegamento con l'unità base	<ul style="list-style-type: none"> - Verificare se l'unità portatile è registrata presso l'unità base ovvero se l'unità portatile è stata registrata presso l'unità base utilizzando il codice PIN corretto ➤ pagina 119.
Collegamento disturbato, interrotto	<ul style="list-style-type: none"> - La distanza dall'unità base è troppo grande. - Errata ubicazione dell'unità base.
Durante la telefonata si avvertono segnali acustici	<ul style="list-style-type: none"> - La distanza dall'unità base è troppo grande. - Le batterie sono quasi scariche.

Problemi

Domande	Risposte
Il sistema non reagisce più	<ul style="list-style-type: none">- Ripristinare la configurazione iniziale per tutte le funzioni ☞ pagina 119.- Estrarre brevemente l'alimentatore di rete dalla presa di corrente.
Le batterie si scaricano piuttosto subito	<ul style="list-style-type: none">- Le batterie sono scariche o difettose.- Riporre l'unità portatile correttamente nella stazione base/stazione di carica. Pulire le superfici di contatto su unità portatile e stazione base (stazione di carica con un panno morbido e asciutto).- Posizionare l'unità portatile per 8 ore nella stazione base/stazione di carica.
Le batterie non si lasciano più ricaricare	<ul style="list-style-type: none">- Le batterie sono difettose.
La visualizzazione del numero di chiamata (CLIP) non funziona	<ul style="list-style-type: none">- La visualizzazione del numero di chiamata è un servizio addizionale offerto dal proprio gestore di rete telefonica. Per maggiori dettagli rivolgersi al proprio gestore di rete telefonica.- Il chiamante ha disattivato la trasmissione del proprio numero di chiamata.
La segreteria telefonica non registra alcun messaggio	<ul style="list-style-type: none">- Verificare se la segreteria telefonica è inserita.- Verificare che la memoria della segreteria telefonica non sia piena. Cancellare se occorre messaggi dalla memoria.
La segreteria non passa alla modalità riproduzione del messaggio di annuncio e registrazione	<ul style="list-style-type: none">- Verificare che la memoria della segreteria telefonica non sia piena. La segreteria passa automaticamente alla modalità di solo annuncio che non prevede la possibilità di lasciare un messaggio. Cancellare se occorre messaggi dalla memoria.
Non è possibile compiere un'interrogazione a distanza	<ul style="list-style-type: none">- Sul telefono utilizzato per l'interrogazione a distanza deve risultare impostata la procedura di selezione a toni.- Verificare se la segreteria telefonica è inserita.- Verificare se il codice PIN per l'interrogazione a distanza utilizzato è corretto ☞ pagina 138. Avendo dimenticato il codice PIN per l'interrogazione a distanza, il menu può essere consultato in questo senso oppure è anche possibile resettare il telefono e ripristinare quindi la configurazione iniziale del PIN.- Premere i tasti lentamente e con sufficiente pressione.- Avviare l'interrogazione a distanza mentre il messaggio di annuncio è ancora riprodotto. Se dalla riproduzione risulta che il messaggio di annuncio è troppo breve, registrare un messaggio di annuncio più lungo.

12 Consigli per la cura/Garanzia

Consigli per la cura

- Pulire le superfici degli apparecchi con un panno morbido e antipelucchi.
- Non utilizzare mai detersivi o solventi.

Al di là di una occasionale pulizia dell'involucro esterno non è necessario compiere alcuna operazione di pulizia.

Garanzia

Gli apparecchi SWITEL sono costruiti e collaudati in osservanza dei processi di produzione più moderni. L'impiego di materiali selezionati e tecnologie altamente sviluppate sono garanti di una perfetta funzionalità e lunga durata in vita. La garanzia non viene considerata esecutiva qualora la causa del malfunzionamento dell'apparecchio sia riconducibile al gestore della rete telefonica oppure se questa è da attribuirsi ad un impianto telefonico interno interposto. La garanzia non si estende a pile, batterie ricaricabili o pacchi batteria utilizzati all'interno degli apparecchi. Il periodo di garanzia ricopre 24 mesi a partire dalla data di acquisto.

Entro il periodo di garanzia si procederà all'eliminazione gratuita di tutti i guasti dovuti a difetti di materiale o produzione. Il diritto di garanzia cessa in caso di interventi da parte dell'acquirente o di terzi. Danni derivanti da un impiego o esercizio non conforme agli usi previsti, a naturale usura, a errato montaggio o errata conservazione, a collegamento o installazione impropri, dovuti a forza maggiore o ad altri influssi esterni non sono coperti da garanzia. In qualità di produttore ci riserviamo il diritto, in caso di reclami, di riparare o sostituire le parti difettose o di rimpiazzare l'apparecchio. Parti o apparecchi sostituiti passano di nostra proprietà. Sono esclusi diritti di risarcimento per danni qualora non siano dovuti a intenzione o colpa grave del costruttore.

Nel caso in cui il presente apparecchio dovesse ciò nonostante presentare un difetto durante il periodo di garanzia, si prega di rivolgersi esclusivamente al negozio di rivendita dell'apparecchio SWITEL assieme al relativo scontrino di acquisto. In base alle presenti disposizioni, tutti i diritti di garanzia dovranno essere fatti valere esclusivamente nei confronti del rivenditore autorizzato.

Decorso il termine di due anni dalla data di acquisto e consegna dei nostri prodotti non sarà più possibile fare valere alcun diritto di garanzia.

13 Indice alfabetico

A

- Accettare una chiamata, 136
- Accettare una chiamata esterna con telefonata interna in corso, 123
- Alimentatore di rete, 104
- Alimentazione elettrica, 144
- Ampliare il sistema telefonico, 140
- Annullare la registrazione, 141
- Annullare la registrazione di un'unità portatile, 141
- Apparecchiature mediche, 105
- Attivare, 133
- Attivare la segreteria tramite interrogazione a distanze, 139
- Autonomia di stand-by, 144
- Avviare l'interrogazione a distanza, 138

B

- Batterie ricaricabili, 105, 144
- Blocco dei tasti, 121, 131
- Blocco di chiamata, 132

C

- Caduta di tensione, 104
- Cancellare i messaggi, 136
- Cancellare l'elenco di ripetizione di chiamata, 128
- Cancellare numeri dall'elenco chiamate, 129
- Cancellare singoli numeri di chiamata, 129
- Cancellare tutte le voci, 127
- Cancellare tutti i messaggi, 136
- Cancellare tutti i numeri di chiamata, 129
- Cancellare un numero dall'elenco di ripetizione di chiamata, 128
- Cancellare una voce, 127
- Cancellare voci in rubrica, 127
- Caricare le batterie, 108
- Cercare l'unità portatile, 131
- Chiamata d'emergenza, 132
- Chiamata in attesa, 123
- Chiamate in conferenza, 123
- Chiamate perse, 129
- CLIP, 132, 143
- Codice di accesso, 142
- Codice PIN per interrogazione a distanza (configurazione iniziale), 144
- Codice PIN per l'interrogazione a distanza, 138
- Collegare l'unità base, 107
- Collegare la stazione di carica, 107
- Compatibilità con apparecchi acustici, 105
- Compiere chiamate interne, 122, 123
- Compiere telefonate, 122
- Concludere l'interrogazione a distanza, 138
- Concludere la chiamata, 121
- Consigli per la cura, 147
- Contenuto della confezione, 106
- Contrasto di display, 130
- Creare voci in rubrica, 126

D

- DECT, 144
- Dichiarazione di conformità, 145
- Disattivare, 133
- Disattivare e attivare lo squillo di chiamata, 124
- Disattivare la sveglia anzitempo, 132
- Display, 109, 111
- Display LC, 110
- Durata di conversazione, 124, 144
- Durata di registrazione in segreteria, 144
- Durata di registrazione per messaggio, 137

E

- Elementi di comando, 109
- Elenco chiamate, 109, 110, 129
- Elenco di ripetizione di chiamata, 128
- Equalizzatore, 130

F

- Formato di ora e data, 130
- Funzionamento, 121
- Funzione baby controllo, 132
- Funzione vivavoce, 125
- Funzioni a tasti dell'interrogazione a distanza, 139
- Funzioni speciali, 131

G

- GAP, 144
- Garanzia, 147

I

- Impianti telefonici interni, 108, 142
- Impostare il volume del ricevitore, 124
- Impostare il volume di squillo dell'unità base, 124
- Impostare il volume di squillo dell'unità portatile, 124
- Impostare il volume per la riproduzione di messaggi, 136
- Impostare l'ora, 108
- Impostare la data, 108
- Impostare la lingua di display, 108
- Impostare la sveglia, 132
- Impostare lo squillo di chiamata, 130
- Impostare toni e indicazioni, 130
- Indicazioni di sicurezza, 104
- Inoltrare la chiamata, 123
- Inoltro di chiamata, 123
- Inserire le batterie ricaricabili nell'unità portatile, 108
- Inserire nomi, 125
- Inserire testo, 125
- Intercettazione, 136
- Interrogazione a distanza, 138
- Interrompere la registrazione del promemoria, 137

L

- LED di chiamata, 109, 110
- Linea diretta di assistenza, 145
- Lingua dei messaggi di risposta, 134
- Lingue dei messaggi di annuncio standard, 144
- Lingue di menu, 144
- Luogo di installazione, 104

Indice alfabetico

M

- Max. durata di registrazione, 133
- Max. volume del ricevitore, 144
- Memorizzare in rubrica un numero dall'elenco di ripetizione di chiamata, 128
- Menu principale, 114
- Messa in funzione, 106
- Messaggio di risposta, 134
- Microfono sull'unità base, 109
- Microfono sull'unità portatile, 110
- Modalità di stand-by, 112
- Modalità ECO, 108
- Modi di rappresentazione nelle istruzioni per l'uso, 112
- Modificare il PIN, 131
- Modificare voci in rubrica, 126

N

- Navigare nel menu, 112
- Nome del portatile, 130
- Numero di accesso alla rete esterna, 142
- Numero di messaggi presenti in segreteria, 144
- Numero di voci in rubrica, 144
- Numero di voci nell'elenco chiamate, 144
- Numero di voci per ripetizione di chiamata, 144

O

- Opzioni durante la riproduzione, 135

P

- Paging, 131
- Pausa di selezione, 142
- PIN, 140, 144
- Più stazioni base, 141
- Più unità portatili, 140
- Portata, 144
- Prefisso, 131
- Problemi, 145
- Procedura di selezione, 132, 144
- Programmare i tasti di selezione diretta, 127
- Pulizia, 147

R

Registrare, 140
Registrare il messaggio di risposta, 134
Registrare un promemoria, 137
Registrare un'unità portatile, 140
Reset, 131
Ricevere una chiamata, 121
Ricevitore, 109, 110
Ricezione automatica di chiamate, 131
Richiamare chiamate ricevute, 122, 130
Richiamata, 122
Riduzione delle radiazioni, 108
Ripetizione di chiamata, 110, 122
Riprodurre il messaggio di risposta, 134
Riprodurre messaggi, 135
Riprodurre messaggi sull'unità base, 135
Riprodurre messaggi sull'unità portatile, 135
Riscontro, 123
Risparmio di addebiti, 137
Rubrica telefonica, 109, 110, 122, 125

S

Salvare in rubrica, 128, 129
Scopo d'impiego, 104
Segnalazione ottica di chiamata, 110
Segnalazione ottica di chiamata (LED di chiamata), 109, 110
Segreteria integrata nella rete telefonica, 143
Segreteria telefonica, 133
Selezionare, 122
Selezionare la modalità di risposta, 133
Selezionare un numero dall'elenco di ripetizione di chiamata, 128
Selezionare un sottomenu, 113
Selezione diretta, 122
Servizi aggiuntivi, 142
Silenziamento, 125
Silenziamento del microfono, 125
Simboli, 111
Simboli di display, 111
Smaltimento, 105
Squilli, 144
Stato di carica delle batterie, 108
Stazioni base, 141
Struttura di menu, 114
Suono dei tasti, 130
Suono di avviso del livello di carica delle batterie, 130
Suono di avviso di portata, 130
Sveglia, 131

Indice alfabetico

T

- Tasti di selezione diretta, 109, 110
- Tasti numerici, 109, 110
- Tasto asterisco, 109, 110
- Tasto avanti, 109
- Tasto cancelletto, 109
- Tasto cancelletto / Segnale di chiamata off /
Pausa di selezione, 110
- Tasto conversazione, 110
- Tasto freccia giù, 110
- Tasto freccia su, 110
- Tasto indietro, 109
- Tasto INT, 109
- Tasto Menu / OK / Silenziamento, 110
- Tasto OK/Menu, 109
- Tasto On/Off segreteria, 109
- Tasto R, 109, 110, 142
- Tasto riaggancio / On / Off, 110
- Tasto ripetizione di chiamata, 109
- Tasto riproduzione/stop, 109
- Tasto su, 109
- Tasto vivavoce, 109
- Telefonare, 121
- Tempo flash, 142, 144
- Trasferire internamente chiamate esterne, 123

U

- Unità base, 109, 141
- Unità portatile, 110

V

- Verificare la memoria di rubrica, 127
- Visualizzare il numero di chiamata, 143
- Visualizzare il numero di chiamata (CLIP), 132
- Visualizzare numeri dall'elenco chiamate, 129
- Vivavoce, 110
- VMWI, 143
- Voci di rubrica, 113

1	Safety Information	154
2	Starting Up	156
3	Operating Elements	159
4	Preliminary Information	162
5	Menu Structure	164
6	Operation	171
7	Answering Machine	183
8	Extending the Telephone System	190
9	PBX / Supplementary Services	192
10	Technical Properties	194
11	In Case of Problems	195
12	Maintenance / Guarantee	197
13	Index	198

Safety Information

1 Safety Information

Please read this operating instruction manual thoroughly.

Intended use

The telephone with handset and charging station is suitable for telephoning within a public telephone network system. Any other use is considered unintended use. Unauthorised modification or reconstruction is not permitted. Under no circumstances open the devices or complete any repair work yourself.

Power failure

The telephone cannot be used to make calls in the event of a power failure. Always keep a corded telephone which operates without an external power supply available in case of emergency situations.

Installation location

The installation location is a decisive factor to ensure trouble-free operation.

Prevent excessive exposure to smoke, dust, vibration, chemicals, moisture, heat and direct sunlight. Do not use the telephone in potentially explosive areas.

Do not place the telephone in the direct vicinity of other electronic devices such as TV sets, microwave ovens, refrigerators etc., because they can mutually affect each other. Do not place the telephone near another phone. Ensure that no large metallic objects, such as a refrigerator or a mirror, are located between the base unit and handset. Walls, too, can impair the connection between the base unit and handset.

Position the telephone near a suitable power socket and telephone line socket. Pay attention that the cable cannot be tripped over!



Attention: The cables must not be extended!

Place the telephone on a level, non-slip surface. Normally, the device footpads do not leave any marks on the surface where it is located. However, due to the diverse types of paints and surfaces which come into question, it cannot be fully ruled out that the footpads will leave marks on the surface on which it is located.

The higher the base unit is located (even inside a building), the further its range.

Power adapter plug



Attention: Only use the power adapter plug supplied because other power adapter plugs could damage the telephone.

Ensure access to the power adapter plug is not obstructed by furniture or such.

Rechargeable batteries



Attention: Never throw batteries into a fire. Only use batteries of the same type. Pay attention to the correct polarity. Incorrect polarity of the battery represents a risk of explosion during charging.



Attention: Only use the rechargeable batteries prescribed. Never use standard batteries. Risk of explosion!

Medical equipment



Attention: Never use the telephone in the vicinity of medical equipment. Effects on such equipment cannot be fully ruled out.

Hearing aid compatibility

The telephone is compatible with most popular hearing aids on the market. However, it cannot be guaranteed that all hearing aids will work perfectly.

DECT¹ telephones can cause an unpleasant humming sound in hearing aids.

Disposal

In order to dispose of your device, take it to a collection point provided by your local public waste authorities (e.g. recycling centre). According to laws on the disposal of electronic and electrical devices, owners are obliged to dispose of old **electronic and electrical devices** in a separate waste container. The adjacent symbol indicates that the device must not be disposed of in normal domestic waste!



Risks to health and the environment from batteries!

Never open, damage or swallow batteries or allow them to pollute the environment. They could contain toxic and ecologically harmful heavy metals. You are legally obliged to dispose of power packs and batteries at the point of sale or in the corresponding containers provided at collection points by local public waste authorities. Disposal is free of charge. The above symbols indicate that the batteries must not be disposed of in domestic waste and that they must be disposed of at an authorised collection point.



Packaging materials must be disposed of according to local regulations.

¹ DECT: Digital Enhanced Cordless Telecommunication = Standard for cordless telephones.

Starting Up

2 Starting Up

Safety information



Attention: It is essential to read the Safety Information in Chapter 1 before starting up.

Checking the package contents

The package contains:

Content	DCT 587X model			
	DCT 5871	DCT 58721	DCT 58731	DCT 58741
Base unit	1	1	1	1
Power adapter plug	1	1	1	1
Receiver	1	1	1	1
Helix cable for receiver	1	1	1	1
Telephone connection cable	1	1	1	1
Charging station with power adapter plug	1	2	3	4
Handset	1	2	3	4
Batteries (AAA 1.2 V NiMH)	2	4	6	8
Operating manual	1	1	1	1

¹ Visit www.switel.com to find out whether the telephone set is already available.

Putting the units into operation

Connecting the base unit

Connect the base unit as illustrated in the diagram. For safety reasons, only use the power adapter plug supplied.

It is essential to observe the information regarding the installation location;  Page 154.

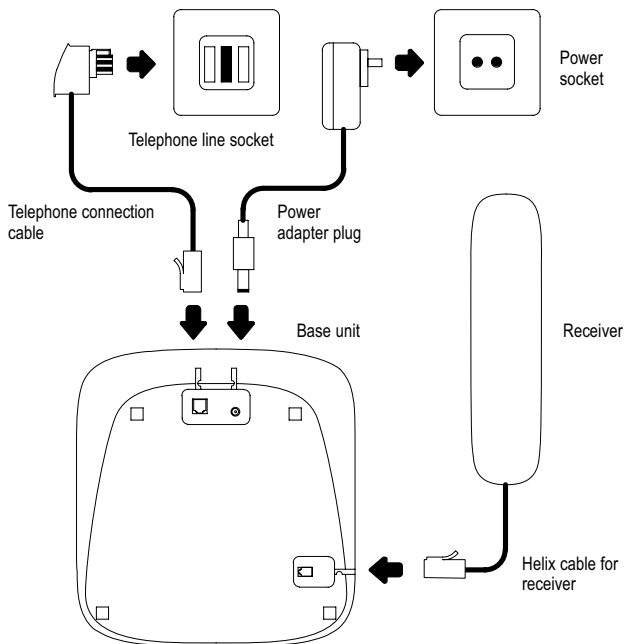

With regard to the base unit, only use the power adapter plug supplied with the output data 100-240 Vac, 6 Vdc 500 mA.

Connecting the charging station

Connect the charging station to a power socket.

Starting Up

Inserting the batteries in the handset

The battery compartment is located on the rear side of the handset. Open the battery compartment and insert the two 2 rechargeable batteries of the type AAA NiMH, 1.2 V 500 mAh. Pay attention to the correct polarity. Close the battery compartment.

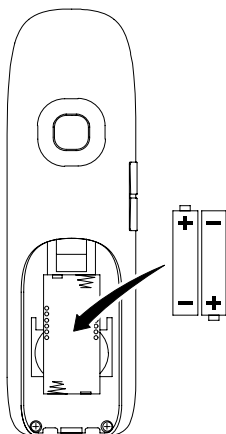

Charging the batteries



Before the handset is used for the first time, insert it in the charging station for **at least 8 hours**.

When the handset is inserted in the charging station properly, you will hear a confirmation signal. The handset warms up during the charging process. This is normal and does not represent a risk. Do not charge the handset with charging units from other manufacturers. The current **battery charge status** is indicated in the display:



Full



Empty

Setting the display language

Select the language required. Refer to Pages 168 and 170 for the sequence of menu option selections.





HS:  > HS setting > Language>...

BS:  > Base setting > Language>...

There are 9 languages available for selection: German, French, Italian, English, Spanish, Portuguese, Dutch, Polish and Turkish.

Setting the date and time

The date and time are set using the menu; (Set time)  Page 167.

Confirm each entry for year, month, day, hour and minute individually by pressing the  or  key. Pay attention to the time and date format set;  Page 167. If the 12-hour format is set, use the  /  key to select whether the time set is before midday (A) or after midday (P).

Private branch exchanges

The information on Page 192 explains how to install your telephone in a private branch exchange.

Low-radiation operation (ECO mode)



















The level of radiation is considerably lower than that of standard DECT cordless telephones in Standby mode when the handset is in the base unit. In talk mode, radiation is reduced according to the distance between the handset and base unit.



3 Operating Elements

The telephone keys in this operating manual are subsequently depicted with a uniform contour. Therefore, slight deviations in the appearance of the symbols on the telephone keys compared to those depicted here are possible.

Base unit

- | | | | |
|----|---|----|---|
| 1 | Receiver | 11 | Forwards key  |
| 2 | OK/Menu key  | 12 | Visual call indicator (Call LED) |
| 3 | Display | 13 | Microphone |
| 4 | Back key  | 14 | Handsfree button  |
| 5 | One-touch dialling keys   | 15 | Hash key  |
| 6 | On/Off button, answering machine  | 16 | R / Delete key  |
| 7 | Scroll up / Call list key  | 17 | Redialling key  |
| 8 | Play/Stop key  | 18 | INT key  |
| 9 | Scroll down / Phone book key  | 19 | Star key  |
| 10 | Reverse key  | 20 | Digit keys  ,  ,  etc. |

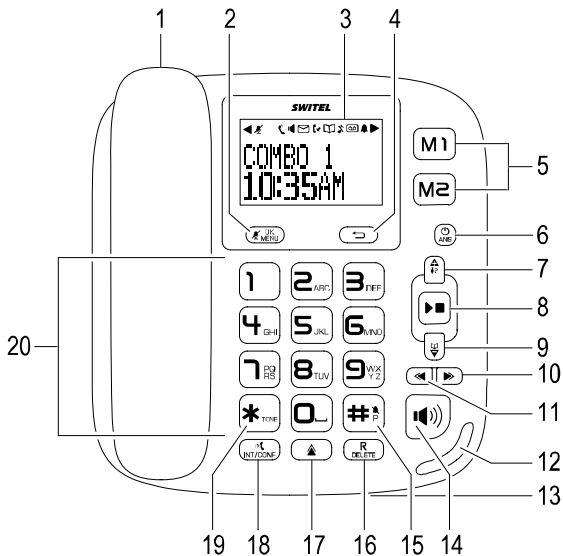

Operating Elements





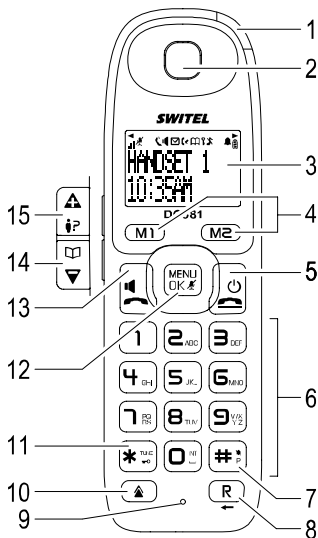

























Handset

- 1 Visual call indicator (Call LED)
- 2 Earpiece
- 3 LC display
- 4 One-touch dialling keys (M1) (M2)
- 5 On/Off / On-hook key (O)
- 6 Digit keys (1) (2)... to (0)
- 7 Hash key / Ringing tone off / Dialling pause (#)
- 8 R-key / Back (R)
- 9 Microphone
- 10 Redialling (A)
- 11 Star key (*)
- 12 Menu/OK/Muting key (MENU/OK)
- 13 Call key / Handsfree facility (CALL)
- 14 Phone book / Arrow down key (DOWN)
- 15 Arrow up / Call list key (UP)



Operating Elements

Icons and texts in the display











Icon	Description
	Indicates the battery capacity (full, half empty, almost empty). Segments empty: The batteries must be charged. Run-through segments: The batteries are being charged;  Page 158. Segments on: The batteries are fully charged.
	Connection to the base unit. Flashing: Poor or no connection. On: Good connection.
	Flashing: A call has been received;  Page 171. On: A call is currently in progress;  Page 171.
	Missed calls. New calls have been registered in the call list;  Page 179.
	You have opened the phone book;  Page 175.
	The entry or display has more characters to the right;  Page 176.
	The entry or display has more characters to the left;  Page 176.
	On: The answering machine is on;  Page 183. Flashing: New messages recorded on the answering machine;  Page 185. Or: The memory capacity of the answering machine is full. Delete messages;  Page 186
	The ringing tone has been switched off;  Page 174.
	The microphone is deactivated (muted);  Page 175.
	The handsfree facility is activated;  Page 175.
	The key lock function is activated;  Page 171.
	The alarm clock is switched on;  Page 181.
	Answering machine provided in the telephone network. VMWI - Supplementary service offered by telephone network providers;  Page 193.

Preliminary Information

4 Preliminary Information

This chapter provides basic information on using the operating instruction manual.

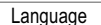
Notation in the manual

Display	Description
	Displays the contour of keys
	Press the key depicted briefly
	Press any key briefly
2 sec. 	Press the key depicted for 2 seconds
	Enter digits or letters
	Handset rings
	Phone rings
	Pick up the receiver or remove the handset from the charging station
	Replace the receiver or place the handset in the charging station
	Depicts text in the display
	Depicts icons in the display
HS1, HS2	Handset 1, handset 2 etc.
BS	Base unit

Standby mode

All the descriptions in this manual assume that the telephone (base unit) and handset are in Standby mode. The telephone (base unit) and handset are in Standby mode when no call is in progress and no menu is open.

Navigating in the menu

All the functions can be accessed by means of the various menus. Refer to the Menu Structure  Page 164 for information on how to access each respective function.



Every process is automatically cancelled if there is no input within 20 seconds.



Open the main menu



Select the required submenu

¹ Letters are also imprinted on the digit keys. Letters, digits and special characters are entered by pressing the relevant key the respective number of times.

Preliminary Information

	Open the submenu
/	Select the required function
	Open the function
/	Select the required setting
	Use the digit keys to enter numbers or letters
	Confirm the input
	Return to the previous menu level
	Cancel all programming and saving and return the handset to Standby mode



Many entries which are concluded by pressing the key are confirmed by an accompanying acoustic signal.

Creating phone book entries - example

The way in which to navigate through the menus and select settings is explained by means of the example **Creating phone book entries** (handset). Proceed as in this example for all the settings.







	Open the main menu
/ Phonebook	Open the phone book
Add	Select the submenu and confirm it
Enter name	Enter the name (max. 12 characters) and confirm it
Number	Enter phone number 1 (mobile number) (max. 24 digits) and confirm it
Number	Enter phone number 2 (landline number) (max. 24 digits) and confirm it
VIP melody , / ,	Assign a ringing tone
	Return to Standby mode



Two phone numbers can be stored per name or entry. The first memory location is preceded by a mobile phone icon, the second memory location a house icon. Therefore, we recommend only programming mobile phone numbers for the first memory location and only landline numbers to the second memory location.

Menu Structure

5 Menu Structure

Press the  or  key to open the main menu. Then use the  /  keys to select an entry and confirm your selection by pressing the  or  key. Further information on the menu and operation:  Chapter 4.

Ans machine

Answer mode	
	Ans and Rec
	Answer only
	Off
Del all old	
Record memo	
OGM1	
	Play OGM
	Delete MSG
	Record OGM
OGM2	
	Play OGM
	Delete MSG
	Record OGM
Call screen	On / Off
Ring delay	
	Toll saver
	08 Rings
	06 Rings
	04 Rings
	02 Rings

Menu Structure

ICM length	180 Sec
	150 Sec
	120 Sec
	90 Sec
Voice lang	DEUTSCH
	FRANÇAIS
	NEDERLANDS
	ITALIANO
Remote PIN	

Intercom



Handset 01 - 06 ¹

¹ Display according to the number of the handsets registered



Menu Structure

Phonebook

Add

Enter name	 1
Number	
Number	
VIP melody	01 / 02 / ... / Off

Edit

Enter name	 1
Number	
Number	
VIP melody	01 / 02 / ... / Off

Delete

Delete all

Copy to

M1

M2

Usage

¹ Letters are also imprinted on the digit keys. Letters, digits and special characters are entered by pressing the relevant key the respective number of times.

Menu Structure

Clock/Alarm

Set alarm

Once

Off

On

Enter time 

Daily

Off

On

Enter time 

Date format

DD/MM

MM/DD

Time format

24-hour

12-hour

Set time ¹





¹ The date and time are set using this menu option.

Menu Structure

Only available on a handset:

HS setting ¹

HS sound	
Ring volume	05 / ... / 01 / Off
Ext. ring	12 / ... / 01
Int. ring	12 / ... / 01
Key tone	Off / Tone / Ring tone
Low batt	On / Off
Out-of-range	On / Off
Equalizer	
Natural	
Bass	
Treble	
LCD contrast	06 / ... / 01
Handset Name  ²	
Auto Answer	On / Off
Baby call	
Off	
On	Enter Number 
Auto keylock	On / Off
Language	(9 languages)

¹ This menu option is only displayed on the handset.

² Letters are also imprinted on the digit keys. Letters, digits and special characters are entered by pressing the relevant key the respective number of times.

Menu Structure

Only available on a handset:

Base setting ¹

Clear VMWI

Register

Base 1	PIN? ²
--------	-------------------

Base 2	PIN? ²
--------	-------------------

Base 3	PIN? ²
--------	-------------------

Base 4	PIN? ²
--------	-------------------

Select base

Base 1

Base 2

Base 3

Base 4

Auto

Advance

Dial mode	Tone / Pulse
-----------	--------------

Recall time	Short / Medium / Long
-------------	-----------------------

Prefix	
--------	---

Call barring	04 / ... / 01  Enter Number 
--------------	---

SOS number	04 / ... / 01  Enter Number 
------------	--

Deregister	Handset
------------	---------

Change pin	PIN? 
------------	--

Reset	Confirm?
-------	----------







¹ This menu with precisely these submenus are only displayed on the handset.

² The default PIN code is "0000".

Menu Structure

Only available on the base unit:

Base setting¹

Melody		
	Ring volume	05 / ... / 01 / Off
	Ext. ring	12 / ... / 01
	Int. ring	12 / ... / 01
	Key tone	Off / Tone / Ring tone
LCD contrast	06 / ... / 01	
Clear VMWI	06 / ... / 01	
Language	(9 languages)	
Register		
	Base 1	PIN? ²
	Base 2	PIN? ²
	Base 3	PIN? ²
	Base 4	PIN? ²
Advance		
	Dial mode	Tone / Pulse
	Recall time	Short / Medium / Long
	Prefix	
	Call barring	04 / ... / 01  Enter Number 
	SOS number	04 / ... / 01  Enter Number 
	Deregister	Handset
	Change pin	PIN? 
	Reset	Confirm?

¹ This menu with precisely these submenus is only displayed on the base unit.

² The default PIN code is "0000".

6 Operation

Many functions can be operated from both the base unit as well as the handset. Please note that many of the keys depicted below are provided on both the base unit as well as the handset;

☞ Page 159.



However, when completing an operating sequence, you may not switch between operation on the base unit and operation on the handset. Before beginning with an operating sequence, decide whether you want to complete it using the base unit or handset.

Switching the handset on / off

No calls are received on the handset when it is switched off.

No battery power is used when the handset is switched off.



No emergency calls can be made from the handset when it is switched off. The handset must be switched on beforehand, which can take a little time.

2 sec.

Switch the handset on (in Standby mode)

2 sec.

Switch the handset off

Key lock

The key lock feature prevents functions assigned to keys being activated accidentally.

1 sec.

Activate the key lock function



Incoming calls can still be taken in the normal way even when the key lock function is activated. Emergency (SOS) calls can still be made when the key lock function is active (via the SOS call numbers).

1 sec.

Deactivate the key lock function

When the key lock is activated, the icon appears in the display.

The phone can be set-up so that the key lock is automatically activated after 90 seconds;

☞ Page 181.

Telephoning

Taking a call

In addition to the ringing tone, the visual call indicator lights up when a call is received.

or

Take the call



Do not hold the handset too close to your ear when it rings as doing so could cause hearing damage!

If the automatic answering function is activated, the call is taken by simply removing the handset from the charging station; ☞ Page 181.

Ending a call





or

End the call



You can also end the call by replacing the handset in the charging station.

Operation

Making a call







	Enter the phone number (max. 48 digits)
	Delete the last digit if it is wrong
 or  or 	Dial the phone number



It is also possible to make a call by first pressing the  key on the handset or taking the receiver from the base unit or pressing the  key and then waiting for the dialling tone. The digits then entered for the phone number (max. 48 digits) are dialled immediately. It is not possible to correct wrong digits individually using this dialling procedure.

Redialling

The handset stores the last 5 phone numbers dialled together with the date and time of call. If you want to dial a number again, e.g. because the connection was engaged or the call was not taken, use the redialling function:

 ,  / 	Open the redialling list and select the entry required
 or  or 	Dial the phone number

The phone number stored is automatically dialled and a connection established.







Calling back missed calls

Your telephone stores 40 phone numbers in a call list.

 ,  / 	Open the call list and select an entry
 or  or 	Dial the phone number

Dialling numbers from the phone book

Phone numbers must have been stored in the phone book for this function;  Page 176.

 ,  / 	Open the phone book and select an entry
 or  or 	Dial the phone number



In order to access phone book entries more quickly, open the phone book and enter the first letters of the entry required. The first entry beginning with these letters appears in the displayed and is marked.

Dialling phone numbers using the one-touch dialling keys

Phone numbers must have been assigned to the one-touch dialling keys;  Page 177.













 or 	Dial the number
--	-----------------

The phone number stored is automatically dialled.

Internal calls

You must have at least one handset registered on the base unit in order to be able to make internal calls free of charge.

Making internal calls

HS1:  or BS: 	
 /  Intercom ,  or 	Initiate an internal call
HS1/BS:  /  ,  or 	Select the handset or base unit required
HS2: 	Internal call is taken on the other handset
HS1/BS / HS2: 	End the internal call





If the handset you have dialled for an internal call is involved in an external call, you will hear an acoustic signal and Line busy appears in the display.













Taking external calls when an internal call is in progress



















When an external call is received while you are involved in an internal call, a message appears in the display.

	Take the external call
With regard to the handset which did not take the external call, press the  key on it to end the internal call.	

Transferring external calls internally











HS1:  or BS: 	
 /  Intercom ,  or 	While the external call is in progress
 /  ,  or 	Select the handset or base unit required
HS2: 	Internal call is taken on the other handset
HS1:  or BS: 	Forward the call

Holding a call / brokering

HS1:  or BS: 	
 /  Intercom ,  or 	While the external call is in progress
 /  ,  or 	Select the handset or base unit required
HS2: 	Internal call is taken on the other handset
HS1:  or BS:  ,  /  Switching	
 or 	Switch between the callers

Making conference calls

An external call can be transferred to another internal handset for a conference call.

HS1:  or BS: 	
 /  Intercom , 	While the external call is in progress
 /  , 	Select the handset or base unit required
HS2: 	Internal call is taken on the other handset
HS1 or BS: 2 sec.  Conference	Start the conference call
HS1 or BS and HS2: 	End the conference call



Operation

Displaying the duration of a call

A few seconds after a call has begun, the current duration of the call appears in the display in minutes and seconds.

Setting the receiver volume

The volume at the receiver can be adjusted to one of 5 levels during a call.

 /  Raise/Lower the receiver volume

Ringing volume

You can alter the volume of the ringing tone for the handset and base unit separately. There are 5 volumes available for selection as well as the option to switch it off.

Adjusting the ringing volume of the handset

 Open the menu

 /  **HS setting**  Select HS setting

 /  **HS sound**  Select HS sound

 /  **Ring volume**  Select Ring volume

 /  Raise/Lower the ringing tone volume

 Save the settings

Adjusting the ringing volume of the base unit

 Open the menu

 /  **Base setting**  Select Base setting

 /  **Melody**  Select Melody

 /  **Ring volume**  Select Ring volume

 /  Raise/Lower the ringing tone volume

 Save the settings

Switching the ringing tone on and off

3 sec.  Switch the ringing tone off



3 sec.  Switch the ringing tone on



When the ringing tone is switched off, the  icon appears in the display.

You can also deactivate the ringing tone using the menu.

Handsfree

This function is used to listen to the caller via the loudspeaker.

 or  During a call: Activate the handsfree facility

 or  During a call: Deactivate the handsfree facility

When the handsfree function is activated, the  icon appears in the display.

Muting function

You can switch the microphone in the handset or base unit off during a call so that the caller cannot hear you, e.g. if you need to consult someone else nearby, and then switch it on again.

2 sec.  or  During a call: Switch the microphone off (muting)

2 sec.  or  During a call: Switch the microphone on

When the microphone is muted, the  icon appears in the display.

Phone book

You can store up to 50 contacts in the phone book, each with up to 2 phone numbers.

- Always enter the area access code with the phone numbers so that incoming local calls can also be assigned to a phone book entry.
- When the memory capacity is used up, the message **Mem Full** appears if an attempt is made to store another number. To create space, an existing entry must first be deleted.
- The phone book entries are arranged alphabetically.

When the phone book is open, the  icon appears in the display.

The phone book can be accessed from the base unit and handset.

Entering names

Letters are also imprinted on the digit keys. Letters, digits and special characters are entered by pressing the relevant key the respective number of times.

 Enter a space

 Enter a special character

 Delete

 /  Move the cursor





















To enter the same letter twice, press the key to enter the letter. Wait until the cursor skips one position forwards. Enter the letter again.

Operation

Creating phone book entries

Also refer to Page 163

	Open the phone book
 or  Add	Select the submenu and confirm it
 or 	
Enter name   or 	Enter the name (max. 12 characters) and confirm it
Number   or 	Enter phone number 1 (mobile number) (max. 24 digits) and confirm it
Number   or 	Enter phone number 2 (landline number) (max. 24 digits) and confirm it
VIP melody  /   or 	Assign a ringing tone























If the entries are longer than can be shown in the display, the ◀ and ▶ icons appear in the display. They indicate that the entry continues to the left or right of the display, respectively.

When the memory capacity is used up, the message **Mem Full** appears if an attempt is made to store another number. To create space, an existing entry must first be deleted.

If a name already exists under which you want to store a new entry, the message

Double name icon also appears in the display.

Editing phone book entries

	Open the phone book
 /   or 	Select an entry and confirm it
 /  Edit  or 	Select the submenu and confirm it
Enter name   or 	Edit the name (max. 12 characters) and confirm it
Number   or 	Edit phone number 1 (mobile number) (max. 24 digits) and confirm it
Number   or 	Edit phone number 2 (landline number) (max. 24 digits) and confirm it
VIP melody  /   or 	Assign a ringing tone

Deleting phone book entries

Deleting an entry

	Open the phone book
/ , or	Select an entry and confirm it
/ , Delete or	Select the function and confirm it



In order to access phone book entries more quickly, open the phone book and enter the first letters of the entry required. The first entry beginning with these letters appears in the displayed and is marked.

Deleting all entries

	Open the phone book
or	Open the menu
/ , Delete all or	Select the function and confirm it
Confirm? , or	
Empty	Confirm the deleting process
or	
Confirm? , or	Cancel the deleting process

Checking the phone book capacity

You can display how many of the 50 memory locations are already assigned.

	Open the phone book
or	Open the menu
/ , Usage or	Select the submenu and confirm it

Programming one-touch dialling keys

You have the possibility of assigning two numbers already stored in the phone book to the keys **M1** and **M2** respectively, so that they are dialled immediately on pressing the keys (one-touch dialling).

	Open the phone book
/ , or	Select an entry and confirm it
/ , Copy to or	Select the submenu and confirm it
M1 , / , or	Select a one-touch dialling key and confirm it
or	Confirm the phone number displayed

Dialling phone numbers via one-touch dialling key



















Page 172.

Operation









Redialling list

The telephone stores the last 5 phone numbers dialled together with the date and time of call.











Saving a number in the redialling list in the phone book

		Open the redialling list
 / 	 or 	Select an entry and confirm it
 / 	Save Number  or 	Select the submenu and confirm it
Enter name 	 or 	Enter the name (max. 12 characters) and confirm it
Enter Number 	 or 	Edit the phone number if necessary (max. 24 digits) and confirm it
 / 	 or 	Define whether the number is a mobile phone number or a landline number and confirm it

Deleting phone numbers from the redialling list

		Open the redialling list
 / 	 or 	Select an entry and confirm it
 / 	Delete  or 	Select the function and confirm it

Deleting the entire redialling list

		Open the redialling list
 or 		Open the menu
 / 	Delete all  or 	Select the function and confirm it
Confirm?  or 		
Empty		Confirm the deleting process
or		
Confirm?  or 		Cancel the deleting process

Dialling phone numbers from the redialling list

 Page 172

Call list

All incoming calls received in your absence are recorded in a call list. The call list can contain up to 40 phone numbers. The time and date of receipt are recorded for each call.

When the call list is open, the  icon appears in the display.

The last call received appears at the top of the call list.



If calls have been received in your absence, the visual call indicator flashes and the  icon appears in the display. Until the call list is actually opened, the display also indicates how many calls have been received.

Displaying phone numbers in the call list

 /  /  Open the call list and select an entry

Storing a phone number in the call list in the phone book



A phone number in the call list can be stored in the phone book directly.





 /  /  Open the call list and select an entry

 or  Open the menu

 /  Save Number ,  or  Select the submenu and confirm it

Enter name  ,  or  Enter the name (max. 12 characters) and confirm it

Enter Number  ,  or  Edit the phone number if necessary (max. 24 digits) and confirm it

 /  ,  or  Define whether the number is a mobile phone number or a landline number and confirm it

Deleting phone numbers in the call list

Deleting individual phone numbers

 /  /  Open the call list and select an entry

 or  Open the menu

 /  Delete ,  or  Select the submenu and confirm it

Deleting all phone numbers

 Open the call list

 or  Open the menu

 /  Delete all ,  or  Select the submenu and confirm it

Confirm? ,  or  Empty Confirm the deleting process

or

Confirm? ,  or  Cancel the deleting process

Calling back calls received

Operation

Acoustic and visual settings

You can define various settings in order to adapt the telephone to your specific needs:

Setting the ringing tone

It is recommended to set different ringing tones to distinguish between internal and external calls. There are a total of 12 polyphone ringing tones available.

Setting the ringing tone;  Menu Structure, Page 168.

Key tones

The key tones provide confirmation that a key has actually been pressed. The phone can be set-up so that the same tone is issued regardless of the key pressed (Setting: **Tone**) or different key tones are produced (Setting: **Melody**). It is also possible to switch the key tone function off.

Setting the key tones;  Menu Structure, Page 168.

Acoustic warning signal, battery capacity

The acoustic warning signal alerts you to the fact that the battery capacity is low.

Setting the battery capacity acoustic warning signal; (**Low batt**);  Menu Structure, Page 168.

Acoustic warning signal, range

The acoustic warning signal alerts you to the fact that the handset is out of range of the base unit.

Setting the range acoustic warning signal (**Out-of-range**);  Menu Structure, Page 168.

Equalizer

You can adapt the tone of the loudspeaker to your individual needs. You can leave the tone in its **Natural** setting or increase the **Bass** or **Treble** tone.

Setting the equalizer;  Menu Structure, Page 168.

Display contrast

The contrast of the display (**LCD contrast**) of the base unit and handset can be set to one of 6 different levels;  Menu Structure, Pages 168 and 170.

Handset name

You can assign individual names to each handset (**Handset Name**); Menu Structure, Page 168

Time and date format

You can define the format and the sequence in which the time and date should be displayed;  Menu Structure, Page 167.

Other settings

Automatic answering

If this function is activated, an incoming call is taken when the handset is removed from the charging station. The automatic answering function is activated and deactivated using the menu.

Activating automatic answering; Menu Structure, Page 168



The Auto Answer menu option can only be opened in the menu of a handset.

Key lock

When this setting is activated, the key lock function is automatically enabled when no key has been pressed for a period of 90 seconds. When the key lock is activated, the icon appears in the display.

Activating the key lock; Menu Structure, Page 168

Prefix number

You can store a prefix number (Prefix). By pressing and holding the key before or after entering a phone number, the prefix number is set to precede the phone number. Press the key to dial this phone number.

Changing the prefix; Menu Structure, Page 169

Changing the PIN

The PIN code is required in order to register handsets. The PIN set at the factory is "0000".

Changing the PIN; Menu Structure, Page 169 (menu on the base unit)

Reset

This function enables you to reset the phone to its default settings defined at the factory.

Resetting; Menu Structure, Pages 169 and 170

Searching for the handset (Paging)

If you have mislaid your handset you can find it again easily by simply calling the handset from the base unit.



Conditions: The handset is switched on, is within range of the base unit, the batteries are not empty and the handset ringing tone has not been switched off. The latter condition means that the icon must NOT appear in the handset display.

BS:

Initiate an internal call

BS: /

Select the handset to be searched for

BS:

Start paging

Special functions

Alarm clock

The "Alarm clock" function can be used so that you are woken or alerted by the handset at a specific time. When the alarm clock function is activated, the icon appears in the display. The selected tone is played for 1 minute at the set time. The message **Alarm** appears in the display.

Operation

Setting the alarm clock function

You can define whether the alarm clock function should only be set for a one-off alert (Once) or whether the alarm should alert you every day at the same time (Daily).



Setting the alarm; (Set alarm); Menu Structure, Page 167

Stopping the alarm prematurely



Stop the alarm

Baby call

Use this function to store a specific phone number (max. 24 digits) that will be dialled and the handsfree function activated automatically when any key (except  and ) is pressed.

If the function is activated, the  message flashes continually in the display.

Activating baby call;  Menu Structure, Page 168

Call barring

The call barring function prevents handsets dialling phone numbers which begin with digits previously defined and stored. Up to 4 barring numbers with max. 8 digits can be stored.

Activating call barring;  Menu Structure, Page 169

If a phone number which has been barred is dialled, no connection is established. The device issues an acoustic warning signal and returns to Standby mode.

Emergency call numbers (SOS numbers)

You can store up to 4 phone numbers which can still be dialled even when the call barring function is activated. Refer to Page 169 for the sequence of menu option selections.

Dialling mode

The handset can be operated in analogue exchanges (pulse dialling mode) as well in newer digital exchanges (tone dialling mode / DTMF). The dialling mode is controlled via the menu. Refer to Page 169 for the sequence of menu option selections.



If you operate the phone using pulse dialling mode, you can switch to tone dialling mode during a call by pressing the  key and use this mode for the remainder of the call.

Caller number display (CLIP)



The caller number display (CLIP) and display of date and time are optional services offered by your telephone network provider. Contact them for any further information.

If the CLIP function is available for your telephone system (CLIP = Calling Line Identification Presentation), the number of the caller appears in the display when a call is received - as long as callers have agreed to transmission of their phone number.



If you do not take a call received, the information remains in the display for approx. 6 seconds before the current time and date reappear.

7 Answering Machine

The answering machine can store up to 57 messages (59 messages including the outgoing messages). The maximum recording time is 15 minutes (including the outgoing messages).

When the memory capacity for new messages is exhausted, no further messages are recorded.

The answering machine then automatically switches to Answer Only mode.

The answering machine can be operated from the base unit and the handset.

Switching the answering machine on/off

When the answering machine is switched on, the Play/Stop key on the base unit lights up red. In addition, the  icon appears permanently in the displays of the base unit and registered handsets.













The answering machine is switched on by default.

Switching the answering machine on/off from the base unit



Switch the answering machine on/off

Switching the answering machine on from the handset

 ,  /  **Ans machine** ,  ,  /  **Answer mode** ,  ,
 /  **Ans and Rec** or **Answer only** 

 Menu Structure, Page 164

Switching the answering machine off from the handset

 ,  /  **Ans machine** ,  ,  /  **Answer mode** ,  ,
 /  **Off** , 

 Menu Structure, Page 164

Answering modes

The answering machine provides two answering modes: Answer and Record mode (Ans and Rec) and Answer Only mode (Answer only). When Answer and Record mode is active, a message can be left by the caller. If Answer Only mode is active, no message can be left.

Selecting the answering mode

Select the answering mode required;  Menu Structure, Page 164. Refer to the section "Switching the answering machine on/off" on Page 183.



The answering machine is set to Answer and Record mode by default.

Answering Machine

Outgoing message

The answering machine is provided with two, pre-recorded outgoing messages (OGM). Both pre-recorded outgoing messages can be replaced by ones of your own.

When Answer and Record mode is activated, the outgoing message OGM1 is used, when Answer Only mode is activated, outgoing message OGM2 is used.



As soon as your own outgoing message is recorded, only that version is played.

When the answering machine memory space is full, the outgoing message of Answer Only mode is automatically played.

Language of outgoing messages

You can change the language of the pre-recorded outgoing messages on the answering machine. There are 4 languages available for selection.

or , / **Ans machine** ,

or , / **Voice lang** ,

or

Open the submenu

/ , or

Select the language and confirm it

Playing the outgoing message

Menu Structure, Page 164 (Play OGM)

Recording your own outgoing message

A self-recorded outgoing message may be maximally 2 minutes long.

or , / **Ans machine** ,

or

Select the menu

/ **OGM1**

or **OGM2** or

Select the outgoing message

, / **Record OGM** ,

or

Initiate the recording function



Speak your outgoing message

or

End and store the recording

Speak your message clearly and distinctly into the microphone on the base unit (at the front of the unit) or on the handset. On ending the message, it is played back.



Pay attention that the outgoing message recorded is long enough (max. 2 minutes) to be able to use the remote access function should you want to; "Remote access", Page 188.

Reactivating the pre-recorded message

Deleting the outgoing message you recorded yourself automatically reactivates the pre-recorded, default message.

The outgoing message can be deleted by means of the menu;  Menu Structure, Page 164 (Delete MSG).



The pre-recorded messages cannot be deleted.

Playing recorded messages

If new messages have been recorded, the visual call indicator flashes on the base unit and on the registered handsets and the  icon appears in the respective display. A message in plain text also appears in the displays of the base unit and registered handsets indicating the number of new messages.

The incoming messages recorded are numbered in the order they were received.





The messages received are played back in the opposite sequence: the message last recorded is played first.

While the message is being played back, the number of the message is displayed together with the date and time of recording.







Initially, only the new messages are played. To play the old messages, start playback of the messages once again.

















Playing messages on the base unit (via the loudspeaker)

	Play/Stop messages
	Play message again
2x 	Skip to previous message
	Skip to next message

Playing messages on the handset





 /  /  Play message ,	
 Wait	Play messages (via the loudspeaker)

Playback options:

	Open the menu
 /  Delete MSG 	
Deleted	Delete the message
 /  Stop 	Stop playback
 /  Forward MSG 	Play the next message
 /  Repeat MSG 	Repeat current message from the beginning
 /  Backward MSG 	Skip to previous message

Answering Machine

Alternatively, these functions can be performed by pressing the respective keys:

	Delete message
	Repeat current message from the beginning
2x 	Skip to previous message
	Stop playback (Pause)
	Skip to next message

Setting the volume for playing messages

You can adjust the volume on the base unit to one of 5 levels while the message is playing.

	Raise/Lower the volume
---	------------------------

You can adjust the volume on the handset to one of 5 levels while the message is playing.

	Raise/Lower the volume
---	------------------------

Deleting a message

Delete a message during playback:

BS: 	Delete the message
---	--------------------

or

HS: 	Open the menu
---	---------------

HS:  /  	
---	--

	Delete the message
---	--------------------

or

HS: 	Delete the message
---	--------------------

Deleting all messages

All the old messages are deleted.



Messages which have been deleted cannot be restored!



 or  ,   ,
--

 or  ,  ,  or 
--

Screening calls



You can use the loudspeaker on the base unit to listen to incoming calls without actually answering them. In this case, the Call Screen function must be activated in the menu;  Menu Structure, Page 164 (Call screen).



To alter the volume while screening a call, press the  and  keys.

Taking a call being recorded

It is possible to take a call even if the answering machine has already begun to record it. Recording of the message is stopped in this case.

 or  or 	Take the call
---	---------------

Delaying answering a call

Use the menu to define how often the telephone should ring before an outgoing message is played to the caller. You can select between 2, 4, 6 or 8 ringing tones; Menu Structure, Page 164 (Ring delay).



The answering machine is set to 4 rings by default.

In addition, the Toll saver setting is also available for pre-remote access free of charge. The toll-saving pre-remote access feature can be used to check whether new messages have been received on your answering machine from a distant telephone. If new messages have been recorded on your answering machine, your call is taken after 2 rings at the latest. If no new messages have been recorded on your answering machine, your call is taken after 6 rings. Place the receiver on-hook before the 6th ring. This means that no charges ensue.

For further information on remote access, refer to Page 188.

Maximum recording time per incoming message

There are 4 recording times available for selection; Menu Structure, Page 165 (ICM length)

Recording a memo

A memo is a message which you leave on the answering machine for other users and is played back in the same way as a message left by other callers. A memo may be maximally 3 minutes long and recorded on the handset.



Memos can also be recorded when the answering machine is switched off.

or , / **Ans machine** ,

or ,

Select the submenu

or , / **Record memo** ,

or ,

Initiate the recording function



Record the memo

or

End and store the recording

Interrupting recording a memo

BS:

Stop recording and return to the submenu

or

HS: or

Stop recording and return to the submenu

Answering Machine

Remote access

You can call your answering machine from another telephone to switch it on or to play messages and execute other functions. Remember that the calling telephone must support tone dialling.

PIN code for remote access

The Remote PIN is set to "1234" by default. It is recommended to change the Remote PIN to ensure that no unauthorised persons gain access to your answering machine.

Changing the PIN code for remote access;  Menu Structure, Page 165.



If you have changed the PIN code for the remote access function and subsequently forgotten it, refer to the PIN code for remote access in the menu;  Menu Structure, Page 169 (Remote PIN).

Starting remote access

The telephone used for remote access must be set to tone dialling.



Dial your number from an external telephone.



If the answering machine is switched on, the outgoing message is played after the defined number of rings.

If the answering machine is not switched on, the telephone is automatically activated after the 10th ring and a longer acoustic signal is issued.



Initiate the remote access function.
A longer acoustic signal is then issued.



When the answering machine is switched on, you must initiate the remote access function while the outgoing message is being played. Therefore, it is important that the outgoing message is sufficiently long.



Enter the 4-digit PIN for remote access. A longer acoustic signal is then issued.

You can now execute other functions

 Remote access key function assignment table on Page 189.



Press the key to activate the required function . A longer acoustic signal is issued.



You can execute several functions in succession.

Ending remote access



Stop the remote access function

Answering Machine

Remote access, key function assignment

The following table provides an overview of the functions available and the key to press to initiate the respective function.

Key	If <u>no</u> messages are played	If messages are played
0		Delete message
1		Play message again
2	Play message, resume playback	Stop playback (Pause)
3		Play the next message
4	Switch the answering machine on/off	
5	Record memo ¹	
*		Stop playback

Switching on the answering machine via remote access



Dial your phone number from an external telephone. The telephone is switched on after the 10th ring and a longer acoustic signal is issued.



Activate the remote access function. A longer acoustic signal is then issued.



Enter the 4-digit PIN for remote access. A longer acoustic signal is issued.



Activate the answering machine. A longer acoustic signal is issued. The outgoing message is played.



End the call

¹ End recording a memo by ending remote access.

Extending the Telephone System

8 Extending the Telephone System

The internationally approved **GAP**¹ regulates the compatibility of handsets and telephones (base stations/units) from different manufacturers. As a result, it is possible to integrate SWITEL devices and devices from other manufacturers together in one telephone system. It is possible, however, that some functions are not available.

Multiple handsets

Up to 6 handsets can be registered on the base unit.

Registering handsets

Handsets are registered via the menu; ☞ Menu Structure, Pages 169 and 170.

On the base unit:

 /  / , **Base setting**,  Open the menu

 / , **Register**, 
Confirm?, , **Searching** Open the menu

On the handset to be registered:

 /  / , **Base setting**,  Open the menu

 / , **Register**,

, **Base** × Open the menu

 / , **Base** ×,  Select the base unit required

PIN? ,  Enter the PIN² and confirm it



Incorrect digits entered can be deleted by briefly pressing the  key.

The handset searches for the base unit. This process can take up to 2 minutes.

The handset is automatically assigned an internal call number following registration. The internal call number appears in the display.



To register handsets from other manufacturers, please refer to the operating manual supplied with them.

¹ **GAP**: **Generic Access Profile** = Standard for the interoperation of handsets and base stations/units from different manufacturers.

² The default PIN code is "0000".

Extending the Telephone System

Deregistering handsets



You can only deregister a handset from the base unit or another base unit by using another handset registered on the respective base unit. A handset cannot deregister itself.

Handsets are deregistered via the menu; Menu Structure, Pages 169 and 170.

On the base unit:

/ / , **Base setting** , Open the menu

/ , **Advance** , Open the menu

/ , **Deregister** , Open the menu

Handset 0x / ,

Wait

Select the handset and start the deregistration process

Several base stations¹/base units²

You can increase the range of your handset by registering it on several telephones (base stations¹/base units²). It can be registered on up to 4 different telephones (base stations¹/base units²) simultaneously. Each telephone (each base station¹/base unit²) requires its own telephone line socket. Connections can be used with the same call number or with different ones.



Calls in progress cannot be transferred from one telephone (one base station/base unit) to another.

¹ The base of a DC 58x is referred to as a base station.

² The base of a DCT 587x is referred to as a base unit.

9 PBX / Supplementary Services

R-key and recall time, supplementary services

Your telephone supports supplementary services provided by your telephone network provider, such as brokering, call waiting and conference facilities. Press the **R** to use these supplementary services. Please contact your telephone network provider regarding which Recall (Flash) time must be set to use the supplementary services. Also contact your telephone network provider with regard to enabling supplementary services. The recall (flash) time is set using the menu;  Page 169.

R-key on private branch exchanges

If the telephone is connected to a private branch exchange, functions such as transferring calls and automatic call back can be used via the **R** key. Refer to the operating manual provided with your private branch exchange as to which recall (flash) time must be set in order to use these functions. The sales outlet where you purchased the exchange can provide information as to whether the telephone will work properly with the exchange. The recall (flash) time is set using the menu;  Page 169.

Number for an outside line (access code)

When using private branch exchanges, it is necessary to dial an access code to obtain the dialling tone for an outside line. The number for an outside line is often "0" or "9". Dial this number first and wait for the dialling tone. You can then dial the actual phone number.



If one-touch dialling keys are to be used when the phone is connected to a private branch exchange, please take this into consideration and enter the access code before the actual phone number when programming the one-touch dialling keys. It is also possible to program a dialling pause between the number for an outside line and the actual phone number;  Section "Dialling pause".

Dialling pause

When using private branch exchanges, it is necessary to dial an access code to obtain the dialling tone for an outside line. When using some older private branch exchanges, it takes a little time before the dialling tone becomes audible. In the case of such private branch exchanges, a dialling pause can be inserted after the number for an outside line in order to continue dialling directly without having to wait for the dialling tone. The dialling pause is inserted by pressing and holding the ****** key for 3 seconds.

The actual phone number is dialled a certain time after the number for an outside line.



The dialling pause can also be entered with the phone numbers in the phone book.

Caller number display (CLIP¹)



The caller number display (CLIP) is a supplementary service offered by your telephone network provider. Contact your network provider for further information.

If this function is available with your telephone line, the number of the caller appears in the display when the phone rings. If the caller has suppressed transmission of their phone number, the corresponding message appears in the display. The phone number is not displayed and, as a result, is not stored in the call list.

Answering machine in the telephone network

An answering machine in the telephone network is a supplementary service offered by many telephone network providers. If your telephone network provider offers an answering machine in the telephone network for you, an icon in the display informs you of new messages received (**VMWI**²). This function can only be used when your telephone network provider actually offers the service. Contact your network provider for further information.

¹ **CLIP**: Calling Line Identification Presentation = Displays the caller's phone number.

² **VMWI**: Visual Message Waiting Indication = Visual indicator that new messages have been recorded.

Technical Properties

10 Technical Properties

Feature	Value
Standard	DECT ¹ -GAP ²
Power supply (base unit)	Input: 100-240 V, 50-60 Hz Output: 6 V, 500 mA
Power supply (charging station)	Input: 100-240 V, 50-60 Hz Output: 6 V, 150 mA
Rechargeable batteries	2 x 1.2 V 500 mAh NiMH, Size: AAA
Range, handset	Outdoors: Approx. 300 m Indoors: Approx. 50 m
Standby time, handset	Up to 110 h
Max. duration of call, handset	Up to 11 h
Max. receiver volume	30 dB
Dialling mode	Tone dialling mode (DTMF) Pulse dialling mode
Recall (Flash) time	Short, Medium, Long
Menu languages	German, French, Italian, English, Spanish, Portuguese, Dutch, Polish, Turkish
PIN (default setting)	0000
Number of ringing melodies	12 (polyphone)
Max. number of phone book entries	50
Max. number of call list entries	40
Max. number of redialling list entries	5
Max. number of messages, answering machine	57
Max. recording time, answering machine	15 min (including outgoing messages)
Languages, pre-recorded messages	German, French, Italian, English
PIN code for remote access (default setting)	1234

¹ **DECT**: Digital Enhanced Cordless Telecommunication = Standard for cordless telephones.

² **GAP**: Generic Access Profile = Standard for the interoperation of handsets and base units from different manufacturers.

Declaration of Conformity

This device fulfils the requirements stipulated in the EU directive:

1999/5/EC directive on radio equipment and telecommunications terminal equipment and the mutual recognition of their conformity. Conformity with the above mentioned directive is confirmed by the CE mark on the device.



Service hotline

Should problems arise with the telephone, please refer to the following information first. In the case of technical problems, you can contact our hotline service, Tel. 0900 00 1675 within Switzerland (Swisscom fees at time of going to print: CHF 2.60/min). In the case of claims under the terms of guarantee, please contact your sales outlet. There is a 2 year period of guarantee.

11 In Case of Problems

Problems	Solutions
No telephone calls possible	<ul style="list-style-type: none">- The telephone or base unit is not connected properly or is defective. Only use the telephone connection cable supplied.- The power adapter plug is not plugged in or there is a complete power failure.- Test whether the telephone connection is in order by using another telephone.- Unfavourable installation location of base unit.- The rechargeable batteries are empty or defective.- You have moved the handset too far from the base unit. To increase the range, you can register a handset on several base units/base stations; Page 191.- The wrong dialling mode is set; Page 169- If several handsets are registered: A call is in progress on another handset.- In the case of internal phone calls: The handset called is out of range of the base unit.- The key lock is activated.- The handset is not switched on.
No connection to the base unit possible	<ul style="list-style-type: none">- Check whether a handset is registered on the base unit or whether the handset was registered on the base unit with the correct PIN; Page 169.
Connection is disturbed or cut off	<ul style="list-style-type: none">- You have moved too far from the base unit.- Unfavourable installation location of base unit.
Acoustic signals can be heard during a phone call	<ul style="list-style-type: none">- You have moved too far from the base unit.- The rechargeable batteries are almost empty.

In Case of Problems

Problems	Solutions
The system no longer responds	<ul style="list-style-type: none">- Reset all functions to their default settings; ☞ Page 169.- Briefly disconnect the power adapter plug from the power socket.
The batteries are empty within a short time	<ul style="list-style-type: none">- The batteries are empty or defective.- Place the handset in the base unit / charging station properly. Clean the contact surfaces on the handset and base unit / charging station with a soft, dry cloth.- Place the handset in the base unit / charging station for 8 hours.
The batteries can no longer be charged	<ul style="list-style-type: none">- The batteries are defective.
The caller number display (CLIP) does not function	<ul style="list-style-type: none">- The caller number display (CLIP) is a supplementary service offered by your telephone network provider. Contact your network provider for further information.- The caller has suppressed the transmission of their phone number.
The answering machine does not record any messages	<ul style="list-style-type: none">- Check that the answering machine is activated.- Check whether the answering machine memory is full. Delete messages, if necessary.
The answering machine cannot be switched to Answer and Record mode	<ul style="list-style-type: none">- Check whether the answering machine memory is full. The answering machine then switches automatically to Answer Only mode in which case no messages can be left. Delete messages, if necessary.
No remote access functions can be executed	<ul style="list-style-type: none">- The telephone used for remote access must be set to tone dialling.- Check that the answering machine is activated.- Check that the correct PIN code has been entered for remote access; ☞ Page 188. If you have forgotten the PIN code for remote access, you can refer to the PIN code for remote access in the menu or reset the phone and PIN code for remote access to the default setting.- Press the keys slowly firmly enough.- Start remote access while the outgoing message is being played. If the length of the outgoing message is too short, record another outgoing message which is longer.

12 Maintenance / Guarantee

Maintenance

- Clean the housing surfaces with a soft, fluff-free cloth.
- Do not use any cleaning agents or solvents.

Apart from occasionally cleaning the housing, no other upkeep is necessary.

Guarantee

SWITEL equipment is produced and tested according to the latest production methods. The implementation of carefully chosen materials and highly developed technologies ensure trouble-free functioning and a long service life. The terms of guarantee do not apply where the cause of equipment malfunction is the fault of the telephone network operator or any interposed private branch extension system. The terms of guarantee do not apply to the batteries or power packs used in the products. The period of guarantee is 24 months from the date of purchase.

All deficiencies related to material or manufacturing errors within the period of guarantee will be redressed free of charge. Rights to claims under the terms of guarantee are annulled following tampering by the purchaser or third parties. Damage caused as the result of improper handling or operation, normal wear and tear, incorrect positioning or storage, improper connection or installation or Acts of God and other external influences are excluded from the terms of guarantee. In the case of complaints, we reserve the right to repair defective parts, replace them or replace the entire device. Replaced parts or devices become our property. Rights to compensation in the case of damage are excluded where there is no evidence of intent or gross negligence by the manufacturer.

If your device does show signs of a defect within the period of guarantee, please contact the sales outlet where you purchased the SWITEL device, producing the purchase receipt as evidence. All claims under the terms of guarantee in accordance with this agreement can only be asserted at the sales outlet. No claims under the terms of guarantee can be asserted after a period of two years from the date of purchase and hand-over of the product.

13 Index

A

- Access code, 192
- Acoustic and visual settings, 180
- Acoustic warning signal, battery capacity, 180
- Acoustic warning signal, range, 180
- Adjusting the ringing volume
 - of the base unit, 174
- Adjusting the ringing volume
 - of the handset, 174
- Alarm clock, 181
- Answering machine, 183
- Answering machine
 - in the telephone network, 193
- Arrow down button, 160
- Arrow up button, 160
- Automatic answering, 181

B

- Baby call, 182
- Back key, 159
- Base stations, 191
- Base unit , 159
- Base units, 191
- Batteries, 155, 194
- Battery charge status, 158
- Brokering, 173

C

- Call barring, 182
- Call key, 160
- Call LED, 159, 160, 179
- Call list, 159, 160, 179
- Call screening, 186
- Callback , 172
- Caller number display, 193
- Caller number display (CLIP), 182
- Calling back calls received, 172, 179
- Calls missed, 179
- Changing the PIN, 181
- Charging the batteries, 158
- Checking the phone book capacity, 177
- Cleaning, 197
- CLIP, 182, 193
- Conference calls, 173
- Connecting the base unit , 157
- Connecting the charging station, 157
- Creating phone book entries, 176

D

- Deactivating the microphone, 175
- Declaration of Conformity, 195
- DECT, 194
- Deleting all entries, 177
- Deleting all messages, 186
- Deleting all phone numbers, 179
- Deleting an entry, 177
- Deleting individual phone numbers, 179
- Deleting messages, 186
- Deleting phone book entries, 177
- Deleting phone numbers
 - from the redialling list, 178
- Deleting phone numbers in the call list , 179
- Deleting the redialling list, 178
- Deregistering, 191
- Deregistering handsets, 191
- Dialling, 172
- Dialling mode, 182, 194
- Dialling pause, 192
- Digit keys, 159, 160
- Display, 159, 161
- Display contrast, 180
- Display icons, 161
- Displaying phone numbers in the call list, 179
- Disposal, 155
- Duration of call, 194

E

- Earpiece, 160
- ECO mode, 158
- Editing phone book entries, 176
- Emergency calls, 182
- Ending a call, 171
- Ending remote access, 188
- Entering names, 175
- Entering text, 175
- Equalizer, 180
- Extending the telephone system, 190

F

- Flash time, 194
- Forwarding calls, 173
- Forwards key, 159

G

- GAP, 194
- Guarantee, 197

H

- Handset, 160
- Handset name, 180
- Handsfree, 175
- Handsfree button, 159
- Handsfree calling, 160
- Hash key, 159
- Hash key / Ringing tone off / Dialling pause, 160
- Hearing aid compatibility, 155
- Holding a call, 173

Index

I

- Icons, 161
- Inserting the batteries in the handset, 158
- Installation location, 154
- INT key, 159
- Intended use, 154
- Internal calls, 172
- Interrupting recording a memo, 187

K

- Key lock, 171, 181
- Key tones, 180

L

- Language of outgoing messages, 184
- Languages, pre-recorded messages, 194
- LC display, 160
- Low-radiation, 158

M

- Main menu, 164
- Maintenance, 197
- Making a call, 172
- Making internal calls, 173
- Max. receiver volume, 194
- Maximum recording time, 183
- Medical equipment, 155
- Menu guidance, 162
- Menu languages, 194
- Menu structure, 164
- Menu/OK/Muting key, 160
- Microphone on the base unit , 159
- Microphone on the handset, 160
- Multiple handsets , 190
- Muting function, 175

N

- No. of call list entries, 194
- No. of phone book entries, 194
- No. of redialling list entries, 194
- Notation in the manual, 162
- Number of messages, answering machine, 194

O

- OK/Menu key, 159
- On/Off / On-hook key, 160
- On/Off button, answering machine, 159
- One-touch dialling, 172
- One-touch dialling keys, 159, 160
- Operating elements, 159
- Operation, 171
- Outgoing message, 184

P

- Package contents, 156
- Paging, 181
- Phone book, 159, 160, 172, 175
- Phone book entries, 163
- PIN, 190, 194
- PIN code for remote access, 188
- PIN code for remote access (default setting), 194
- Play/Stop key, 159
- Playback options, 185
- Playing messages, 185
- Playing messages on the base unit , 185
- Playing messages on the handset, 185
- Playing the outgoing message, 184
- Power adapter plug, 154
- Power failure, 154
- Power supply, 194
- Prefix number, 181
- Private branch exchanges, 158, 192
- Problems, 195
- Programming one-touch dialling keys, 177

R

- R-key, 159, 160, 192
- Range, 194
- Recall time, 192
- Receiver, 159
- Recording a memo, 187
- Recording an outgoing message, 184
- Recording time per message, 187
- Recording time, answering machine, 194
- Redialling, 160, 172
- Redialling key, 159
- Redialling list, 178
- Registering, 190
- Registering handsets, 190
- Remote access, 188
- Remote access, key function assignment, 189
- Reset, 181
- Reverse key, 159
- Ringling tones, 194

S

- Safety information, 154
- Saving a number in the redialling list in the phone book, 178
- Saving numbers in the phone book, 178, 179
- Scroll down key, 159
- Scroll up key, 159
- Searching for the handset, 181
- Selecting submenus, 163
- Selecting the answering mode, 183
- Service hotline, 195
- Setting the alarm clock, 182
- Setting the date, 158
- Setting the display language, 158
- Setting the receiver volume, 174
- Setting the ringing tone, 180
- Setting the time, 158
- Setting the volume for playing messages, 186
- Several base stations, 191
- Special functions, 181
- Standby mode, 162
- Standby time, 194
- Star key, 159, 160
- Starting remote access, 188
- Starting Up, 156
- Stopping the alarm prematurely, 182
- Supplementary services, 192
- Switching off, 183
- Switching on, 183
- Switching on the answering machine via remote access, 189
- Switching the ringing tone on and off , 174

Index

T

- Taking a call, 171
- Taking a call being recorded, 186
- Taking external calls when an internal call is in progress, 173
- Talk time, 174
- Telephoning, 171
- Time and date format, 180
- Toll saver, 187
- Transferring calls, 173
- Transferring external calls internally, 173

V

- Visual call indicator, 160
- Visual call indicator (Call LED), 159, 160
- VMWI, 193

Wichtiger Hinweis

Die Basisstation Ihres Telefons ist mit einem energieeffizienten Schaltnetzteil (Input 100~240 V_{AC}, Output 6 V_{DC}, 500 mA) ausgestattet. Die Nulllast beträgt ca. 0,15 W. Die durchschnittliche Effizienz beträgt 71 %. Die Leistungsaufnahme der Basisstation beträgt max. 0,78 W.

Die mit einem Telefonset gelieferte(n) Ladestation(en) ist/sind mit einem energieeffizienten Schaltnetzteil (Input 100~240 V_{AC}, Output 6 V_{DC}, 150 mA) ausgestattet. Die Nulllast beträgt ca. 0,17 W. Die durchschnittliche Effizienz beträgt 67 %. Die Leistungsaufnahme der Ladestation beträgt max. 0,22 W.

Note importante

La base de votre téléphone est équipée d'une alimentation à découpage à efficacité énergétique (entrée 100~240 V_{AC}, sortie 6 V_{DC}, 500 mA). La puissance nulle est d'env. 0,15 W. L'efficacité moyenne est 71 %. La puissance absorbée de la base est max. 0,78 W.

La (les) station(s) d'accueil fournies avec un kit téléphonique est/sont équipée(s) d'une alimentation à découpage à efficacité énergétique (tension d'entrée 100~240 V_{AC}, tension de sortie 6 V_{DC}, 150 mA). La puissance nulle est d'env. 0,17 W. L'efficacité moyenne est 67 %. La puissance absorbée de la station d'accueil est max. 0,22 W.

Avvertimento importante

La stazione base del telefono è dotata di alimentatore (input 100~240 V_{AC}, output 6 V_{DC}, 500 mA) particolarmente efficiente in termini di consumo energetico. La potenza a vuoto corrisponde a ca. 0,15 W. L'efficienza media è 71 %. L'assorbimento di corrente della stazione base corrisponde a max. 0,78 W.

La(e) stazione(i) di carica fornita(e) con il set telefonico è/sono dotata(e) di alimentatore (input 100~240 V_{AC}, output 6 V_{DC}, 150 mA) particolarmente efficiente in termini di consumo energetico. La potenza a vuoto corrisponde a ca. 0,17 W. L'efficienza media è 67 %. L'assorbimento di corrente della stazione di carica corrisponde a max. 0,22 W.

Important note

The telephone base station is equipped with an energy-efficient switching power supply (input 100~240 V_{AC}, output 6 V_{DC}, 500 mA). The zero load is approx. 0.15 W. The average efficiency is 71%. The power consumption of the base station max. 0.78 W.

The charging unit(s) supplied with the telephone set is/are equipped with an energy-efficient switching power supply (input 100~240 V_{AC}, output 6 V_{DC}, 150 mA). The zero load is approx. 0.17 W. The average efficiency is 67%. The power consumption of the charging station max. 0.22 W.

SWITEL

Declaration of Conformity



Diese Anlage entspricht der europäischen R&TTE Richtlinie.
Für die komplette Konformitätserklärung nutzen Sie bitte den kostenlosen Download von unserer Website www.switel.com.

Cet équipement est conforme à la directive européenne R&TTE.
Pour obtenir la déclaration de conformité intégrale, veuillez vous servir du téléchargement gratuit de notre site Internet www.switel.com.

Quest'apparecchiatura è conforme alla direttiva europea R&TTE.
Per la dichiarazione di conformità completa si prega di voler usufruire del servizio gratuito di download dal nostro sito Internet www.switel.com.

This equipment complies with the European R&TTE directive.
To view the complete Declaration of Conformity, please refer to the free download available at our web site: www.switel.com.

Service Hotline

Bei technischen Problemen können Sie sich an unsere Service-Hotline unter Tel. 0900 00 1675 innerhalb der Schweiz (Kosten Swisscom bei Drucklegung: CHF 2,60/min) wenden.

S'il s'agit de problèmes techniques, vous pouvez vous adresser à notre hotline de service en Suisse en appelant le numéro 0900 00 1675 (frais Swisscom à la date d'impression de ce manuel : CHF 2,60/min).

In caso di problemi tecnici è possibile rivolgersi alla nostra hotline di assistenza tecnica chiamando al numero 0900 00 1675 valido per la Svizzera (spese da rete Swisscom alla data di stampa: CHF 2,60 / min).

In the event of technical problems, you can contact our hotline service, Tel. 0900 00 1675 within Switzerland (cost via Swisscom at time of going to print: CHF 2.60/min).