

SWITEL

SWISS BRAND 

Low-radiation cordless DECT/GAP telephone



Vita
DC 500x

**Operating
Instructions**

1	Safety Information	106
2	Starting Up	108
3	Operating Elements	110
4	Preliminary Information	113
5	Menu Structure	115
6	Operation	119
7	Extending the Telephone System	130
8	PBX / Supplementary Services	131
9	Technical Properties	133
10	In Case of Problems	134
11	Maintenance / Guarantee	135
12	Index	136

Safety Information

1 Safety Information

Please read this operating instruction manual thoroughly.

Intended use

The telephone set, comprised of handset(s) and base station, is suitable for telephoning within a public telephone network system. Any other use is considered unintended use. Unauthorised modification or reconstruction is not permitted. Under no circumstances open the device or complete any repair work yourself.

Power failure

The telephone cannot be used to make calls in the event of a power failure. Always keep a wired telephone which operates without an external power supply available in case of emergency situations.

Installation location

The installation location is a decisive factor to ensure trouble-free operation.

Prevent excessive exposure to smoke, dust, vibration, chemicals, moisture, heat and direct sunlight. Do not use the telephone in potentially explosive areas.

Do not place the telephone (base station) in the direct vicinity of other electronic devices such as TV sets, microwave ovens, refrigerators etc., because they can mutually affect each other. Do not place the telephone (base station) near another phone. Ensure that no large metallic objects, such as a refrigerator or a mirror, are located between the base station and handset. Walls, too, can impair the connection between the base station and handset.

Position the telephone (base station) near a suitable power socket and telephone line socket. Pay attention that the cable cannot be tripped over!



Attention: The cables must not be extended!

Place the telephone (base station) on a level, non-slip surface. Normally, the device footpads do not leave any marks on the surface where it is located. However, due to the diverse types of paints and surfaces which come into question, it cannot be fully ruled out that the footpads will leave marks on the surface on which it is located.

The higher the base station is located (even inside a building), the further its range.

Power adapter plug



Attention: Only use the power adapter plug supplied because other adapter plugs could damage the telephone. Ensure access to the power adapter plug is not obstructed by furniture or such.

Rechargeable batteries



Attention: Never throw batteries into a fire. Only use batteries of the same type. Pay attention to correct polarity. Incorrect polarity of the battery represents a risk of explosion during charging.



Attention: Only use the rechargeable batteries prescribed. Never use standard batteries. Risk of explosion!

Medical equipment



Attention: Never use the telephone in the vicinity of medical equipment. Effects on such equipment cannot be fully ruled out.

Hearing aid compatibility

The telephone is compatible with most popular hearing aids on the market. However, it cannot be guaranteed that all hearing aids will work perfectly.

DECT¹ telephones can cause an unpleasant humming sound in hearing aids.

Disposal

In order to dispose of your device, take it to a collection point provided by your local public waste authorities (e.g. recycling centre). According to laws on the disposal of electronic and electrical devices, owners are obliged to dispose of old **electronic and electrical devices** in a separate waste container. The adjacent symbol indicates that the device must not be disposed of in normal domestic waste!



Risks to health and the environment from batteries!

Never open, damage or swallow batteries or allow them to pollute the environment. They could contain toxic and ecologically harmful heavy metals. You are legally obliged to dispose of power packs and batteries at the point of sale or in the corresponding containers provided at collection points by local public waste authorities. Disposal is free of charge. The adjacent symbols indicate that the batteries must not be disposed of in domestic waste and that they must be disposed of at an authorised collection point.



Packaging materials must be disposed of according to local regulations.

¹ DECT: Digital Enhanced Cordless Telecommunication = Standard for cordless telephones.

Starting Up

2 Starting Up

Safety information



Attention: It is essential to read the Safety Information in Chapter 1 before starting up.

Checking the package contents

The package contains:

Content	DC 500X-Model			
	DC 5001*	DC 5002*	DC 5003*	DC 5004*
Base station with power adapter plug	1	1	1	1
Charging station with power adapter plug	-	1	2	3
Handset	1	2	3	4
Telephone connection cable	1	1	1	1
Batteries (AAA 1.2 V NiMH)	2	4	6	8
Operating manual	1	1	1	1

Putting the handset into operation

Connecting the base station

Connect the base station as illustrated in the diagram. For safety reasons, only use the power adapter plug supplied.

It is essential to observe the information regarding the installation location; Page 106.

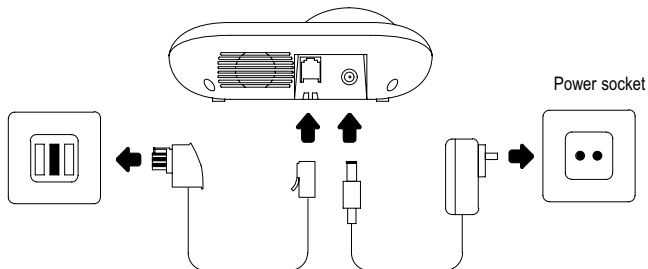

With regard to the base station, only use the power adapter plug supplied labelled with the output data 100-240 Vac 6 Vdc 500 mA.

* Visit www.switel.com to find out whether the telephone/telephone set is already available.

Inserting the batteries

The battery compartment is located on the rear side of the handset. Open the battery compartment and insert the two rechargeable batteries of the type AAA NiMH, 1.2 V 500 mAh. Pay attention to the correct polarity. Close the battery compartment.

Charging the batteries



Before the handset is used for the first time, insert it in the base/charging station for **at least 8 hours**.

When the handset is inserted in the base/charging station properly, you will hear a confirmation signal. The handset warms up during the charging process. This is normal and does not represent a risk. Do not charge the handset with charging units from other manufacturers. The current **battery charge status** is indicated in the display:



Full



Empty

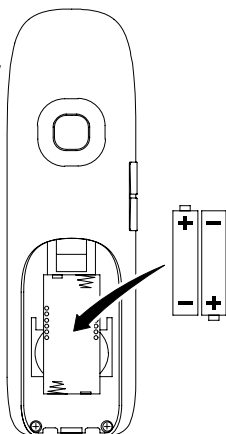

Setting the display language





Select the language required. Refer to Page 117 for the sequence of menu option selections.

 > HS setting > Language >...

There are 9 languages available for selection: German, French, Italian, English, Spanish, Portuguese, Dutch, Polish and Turkish.

Setting the date and time

The date and time are set using the menu;  Page 116.

Confirm each entry for year, month, day, hour and minute individually by pressing the  button. Pay attention to the time format set;  Page 116. If the 12-hour format is set, use the  /  buttons to select whether the time set is before midday (A) or after midday (P).

Private branch exchanges

The information on Page 131 explains how to install your telephone (base station) in a private branch exchange.

Low-radiation operation (ECO mode)

The level of radiation is considerably lower than that of standard DECT cordless telephones in Standby mode when the handset is in the base station. In talk mode, radiation is reduced according to the distance between the handset and base station.













Operating Elements

3 Operating Elements

The telephone buttons in this operating manual are subsequently depicted with a uniform contour. Therefore, slight deviations in the appearance of the symbols on the telephone keys compared to those depicted here are possible.





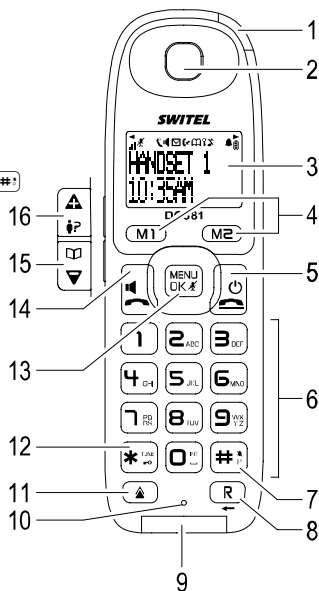





















Handset

- 1 Call LED (visual call alert)
- 2 Earpiece
- 3 LC display
- 4 One-touch dialling buttons **M1** **M2**
- 5 On-hook button / Off button 
- 6 Keypad , ... to 
- 7 # button / Ringing tone off / Dialling pause **##**
- 8 R-signal button / Back **R**
- 9 Visual call indicator 
- 10 Microphone
- 11 Redialling 
- 12 Star button ***-**
- 13 Menu / OK / Muting button 
- 14 Call button / Handsfree mode 
- 15 Arrow down button / Phone book 
- 16 Arrow up button / Call list 



Operating Elements

Icons and texts in the handset display

Icon	Description
	Displays the current battery charge capacity. Off: The batteries must be charged. Run-through segments: The batteries are being charged;  Page 109.
	Connection to the base station. The more bars displayed the better the connection (max. 3 bars).
	Flashing: A call has been received;  Page 119. On: A call is currently in progress;  Page 119.
	Missed calls. New calls have been registered in the call list;  Page 126.
	You have opened the phone book;  Page 123.
	The entry or display has more characters to the right;  Page 123.
	The entry or display has more characters to the left;  Page 123.
	The ringing tone has been switched off;  Page 122.
	The microphone is deactivated (muted);  Page 123.
	The handsfree facility is activated;  Page 122.
	The key lock function is activated;  Page 119.
	The alarm clock is switched on;  Page 129.
	Answering machine provided in the telephone network. VMWI - Supplementary service offered by telephone network providers;  Page 132.

Operating Elements

Base station



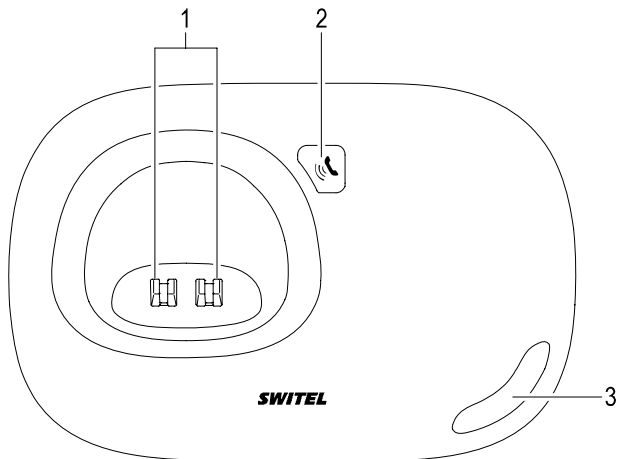







- 1 Charging contacts
- 2 Paging button 
- 3 Call LED (visual call alert)



4 Preliminary Information

This chapter provides basic information on using the operating instruction manual.

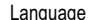
Description of operating sequences in the manual

Display	Description
	Displays the contour of keys
	Press the key depicted briefly
	Press any button briefly
2 sec. 	Press the button depicted for 2 seconds
	Enter digits or letters
	Handset rings
	Base station rings
	Remove handset from base station
	Replace handset in base station
	Depicts text in the display
	Depicts icons in the display

Standby mode







All the descriptions in this manual assume that the telephone (base station) and handset are in Standby mode. The telephone (base station) and handset are in Standby mode when no call is in progress and no menu is open.

Navigating in the menu

All the functions can be accessed via the various menus. Refer to the Menu Structure  Page 115 for information on how to access each respective function.







Every process is automatically cancelled if there is no input within 20 seconds.

	Open the main menu
	Select the required submenu
	Open the submenu
	Select the required function
	Open the function
	Select the required setting

¹ Letters are also imprinted on the digit keys. Letters, digits and special characters are entered by pressing the relevant key the respective number of times.

Preliminary Information

















	Use the digit keys to enter numbers or letters
	Confirm the input
	Return to previous menu level
	Cancel all programming and saving processes and return the handset to Standby mode



Many entries which are concluded by pressing the  button are confirmed by an accompanying acoustic signal.

Creating phone book entries - example





The way in which to navigate through the menus and select settings is explained by means of the example **Creating phone book entries** (handset). Proceed as in this example for all the settings.

	Open the main menu
 /  Phonebook 	Open the phone book
 Add 	Select the submenu and confirm it
Enter name  	Enter the name (max. 12 characters) and confirm it
Number  	Enter phone number 1 (mobile number) (max. 24 digits) and confirm it
Number  	Enter phone number 2 (landline number) (max. 24 digits) and confirm it
VIP melody  /  	Assign a ringing tone
	Return to Standby mode



Two phone numbers can be stored per name or entry. The first memory location is preceded by a mobile phone icon, the second memory location a house icon. Therefore, we recommend only programming mobile phone numbers for the first memory location and only landline numbers for the second memory location.

5 Menu Structure



Press the  button to open the main menu. Then use the  /  buttons to select an entry and confirm it by pressing the  button. Further information on the menu and operation:  Chapter 4.

Intercom



Handset 01 - 06 (only when the corresponding number of handsets is registered)

Phonebook

Add

Enter name	 ¹
Number	
Number	
VIP melody	01 / 02 / ... / Off

Edit

Enter name	 ¹
Number	
Number	
VIP melody	01 / 02 / ... / Off

Delete

Delete all

Copy to

M1

M2

Usage

¹ Letters are also imprinted on the digit keys. Letters, digits and special characters are entered by pressing the relevant key the respective number of times.

Menu Structure

Clock/Alarm

Set alarm

Once

Off

On

Enter time 

Daily

Off

On

Enter time 

Date format

DD/MM

MM/DD

Time format

24-hour



12-hour

Set time



Menu Structure

HS setting

HS sound	
Ring volume	05 / ... / 01 / Off
Ext. ring	12 / ... / 01
Int. ring	12 / ... / 01
Key tone	Off / Tone / Ring tone
Low batt	On/Off
Out-of-range	On/Off
Equalizer	
Natural	
Bass	
Treble	
LCD contrast	06 / ... / 01
Handset Name 	
Auto Answer	On/Off
Baby call	
Off	
On	Enter Number 
Auto keylock	On/Off
Language	(9 language)

Menu Structure

Base setting

Clear VMWI

Register

Base PIN?²

Base PIN?²

Base PIN?²

Base PIN?²

Select base

Base

Base

Base

Base

Auto

Advance

Dial mode Tone/Pulse

Recall time Short/Medium/Long

Prefix 

Call barring 04 / ... / 01 
Enter Number 

SOS number 04 / ... / 01 
Enter Number 

Deregister Handset

Change pin PIN? 

Reset Confirm?

² The default PIN code is "0000".

6 Operation

Switching the telephone on and off

No calls can be received when the telephone is switched off.

No battery power is used when the telephone is switched off.



No emergency calls can be made when the telephone is switched off. The telephone must be switched on beforehand, which can take a little time.



Switch the phone on (activate Standby mode)



Switch the phone off

Key lock

The key lock feature prevents functions assigned to buttons being activated accidentally.



Activate the key lock function



Incoming calls can still be taken in the normal way even when the key lock function is activated.



Deactivate the key lock function

When the key lock is activated, the icon appears in the display.

The phone can be set-up so that the key lock is automatically activated after 90 seconds if no operation is carried out; Page 128.

Telephoning

Taking a call

In addition to the ringing tone, the visual call indicator lights up when a call is received.



Take the call



Do not hold the phone too close to your ear when it rings as doing so could cause hearing damage!

If you have activated the automatic answering function, the call is taken when the handset is removed from the base station; Page 128.

Ending a call



End the call

You can also end the call by replacing the handset in the base station.

Making a call



Enter the phone number (max. 24 digits)



Delete the last digit if it is wrong



Dial the phone number





It is also possible to press the button first to obtain the dialling tone for an outside line. The digits then entered for the phone number (max. 48 digits) are dialled immediately. It is not possible to correct wrong digits individually using this dialling procedure.

Operation

Redialling



The handset stores the last 5 phone numbers dialled together with the date and time of the call. If you want to dial a number again, e.g. because the connection was engaged or the call was not taken, use the redialling function:

	Open the redialling list and select the entry required
	Dial the number

The phone number stored is automatically dialled and a connection established.



Calling back missed calls

Your handset stores 40 phone numbers in a call list.

	Open the call list and select an entry
	Dial the number

Dialling numbers from the phone book

Phone numbers must have been stored in the phone book for this function;  Page 123.

	Open the phone book and select an entry
	Dial the number



In order to access phone book entries more quickly, open the phone book and enter the first letters of the entry required. The first entry beginning with these letters appears in the displayed and is marked.

Dialling phone numbers using the one-touch dialling buttons

Phone numbers must have been assigned to the one-touch dialling buttons;  Page 125.





	Dial the number
---	-----------------

The phone number stored is automatically dialled.

Internal calls

There must be two or more handsets (HS1, HS2, ...) registered on your phone (your base station) in order to make internal calls free of charge.

Making internal calls

	Intercom , 	Initiate an internal call
		Dial the internal call number of the required handset
HS2: 		Internal call is taken on the other handset
HS1 / HS2: 		End the internal call



If the handset you have dialled for an internal call is involved in an external call, you will hear an acoustic signal and Line busy appears in the display.

Taking external calls when an internal call is in progress



When an external call is received while you are involved in an internal call, a message appears in the display.



Take the external call

With regard to the handset which did not take the external call, press the  button to end the internal call.

Transferring external calls internally

 /  /  , **Intercom** , 

While the external call is in progress

 /  , 

Dial the internal call number of the handset required

HS2: 

Internal call is taken on the other handset

HS1: 

Forward the call

or

3 sec.  **Intercom**

While the external call is in progress

 /  , 

Dial the internal call number of the handset required

HS2: 

Internal call is taken on the other handset

HS1: 

Forward the call

Holding a call / brokering

 /  /  , **Intercom** , 



While the external call is in progress

 /  , 

Dial the internal call number of the handset required

HS2: 

Internal call is taken on the other handset

 /  /  , **Switching** , 

Switch to the other caller

Making conference calls

An external call can be transferred to another internal handset for a conference call.

 /  /  , **Intercom** , 

While the external call is in progress

 /  , 

Dial the internal call number of the handset required

HS2: 

Internal call is taken on the other handset

HS1: 2 sec.  , **Conference**







Start the conference call

HS1 / HS2: 

End the conference

Operation

or

3 sec.  Intercom	While the external call is in progress
 /  ,  MENU OK #	Dial the internal call number of the handset required
HS1: 2 sec.  , Conference	Start the conference call
HS1 / HS2: 	End the conference

Displaying the duration of a call

A few seconds after a call has begun, the current duration of the call appears in the display in minutes and seconds.

Setting the receiver volume













The volume at the receiver can be adjusted to one of 5 levels during a call.

 / 	Raise/Lower the receiver volume
---	---------------------------------

Ringing volume

Adjusting the ringing volume

You can change the volume of the ringing tone. There are 5 volumes available for selection as well as the option to switch it off.

 MENU OK #	Open the menu
 /  HS setting  MENU OK #	Select HS setting
 /  HS sound  MENU OK #	Select HS sound
 /  Ring volume  MENU OK #	Select Ring volume
 / 	Raise/Lower the ringing tone volume
 MENU OK #	Save the settings

Switching the ringing tone on and off



3 sec. 	Switch the ringing tone off
3 sec. 	Switch the ringing tone on

You can also deactivate the ringing tone using the menu.

When the ringing tone is switched off, the  icon appears in the display.

Handsfree

This function is used to listen to the caller via the loudspeaker.

	During a call: Switch the handsfree function on
	During a call: Switch the handsfree function off

When the handsfree function is activated, the  icon appears in the display.

Muting function

You can switch the microphone in the handset off during a call so that the caller cannot hear you, e.g. if you need to consult someone else nearby, and then switch it on again.

2 sec.  During a call: Switch the microphone off (muting)

2 sec.  During a call: Switch the microphone on

When the microphone is muted, the  icon appears in the display.

Phone book

You can store up to 50 contacts in the phone book, each with up to 2 phone numbers.

- Always enter the area access code with the phone numbers so that incoming local calls can also be assigned to a phone book entry.
- When the memory capacity is used up, the message **Mem Full** appears when an attempt is made to store another number. To create space, an existing entry must first be deleted.
- The phone book entries are arranged alphabetically.

When the phone book is open, the  icon appears in the display.

Entering names

Letters are also imprinted on the digit keys. Letters, digits and special characters are entered by pressing the relevant key the respective number of times.

0 Enter a space

1 Enter a special character

 Delete

 Move the cursor





To enter the same letter twice, press the key to enter the letter. Wait until the cursor skips one position forwards. Enter the letter again.



Creating phone book entries



 Also refer to Page 114

 Open the phone book



 **Add**  Select the submenu and confirm it

Enter name   Enter the name (max. 12 characters) and confirm it

Number   Enter phone number 1 (mobile number) (max. 24 digits) and confirm it

Number   Enter phone number 2 (landline number) (max. 24 digits) and confirm it

VIP melody    Assign a ringing tone

If the entries are longer than can be shown in the display, the  and  icons appear in the display. They indicate that the entry continues to the left or right of the display, respectively.

Operation

When the memory capacity is used up, the message **Mem Full** appears when an attempt is made to store another number. To create space, an existing entry must first be deleted.

If a name already exists under which you want to store a new entry, the message

Double name also appears in the display during the process.

Editing phone book entries

	Open the phone book
/ ,	Select an entry and confirm it
/ , Edit	Select the submenu and confirm it
Enter name	Edit the name (max. 12 characters) and confirm it
Number	Edit phone number 1 (mobile number) (max. 24 digits) and confirm it
Number	Edit phone number 2 (landline number) (max. 24 digits) and confirm it
VIP melody , / ,	Assign a ringing tone

Deleting phone book entries

Deleting an entry

	Open the phone book
/ ,	Select an entry and confirm it
/ , Delete	Select the submenu and confirm it



In order to access phone book entries more quickly, open the phone book and enter the first letters of the entry required. The first entry beginning with these letters appears in the displayed and is marked.

Deleting all entries

	Open the phone book
	Open the menu
/ , Delete all	Select the submenu and confirm it
Confirm? , Empty	Confirm the deleting process

or

Confirm? , or	Cancel the deleting process
-----------------------	-----------------------------

Checking the phone book capacity

You can display how many of the 50 memory locations are already assigned.

	Open the phone book
	Open the menu
/ , Usage	Select the submenu and confirm it

Programming one-touch dialling buttons

You have the possibility of assigning two numbers already stored in the phone book to the buttons **M1** and **M2** respectively, so that they are dialled immediately on pressing the buttons (one-touch dialling).

	Open the phone book
/ ,	Select an entry and confirm it
/ , Copy to	Select the submenu and confirm it
M1 , / ,	Select the one-touch dialling button and confirm it
	Confirm the phone number displayed

Dialling phone number via one-touch dialling button; Page 120.

Redialling list

The handset stores the last 5 phone numbers dialled together with the date and time of call.

Saving a number in the redialling list in the phone book

	Open the redialling list
/ ,	Select an entry and confirm it
/ , Save Number	Select the submenu and confirm it
Enter name	Enter the name (max. 12 characters) and confirm it
Enter Number	Edit the phone number if necessary (max. 24 digits) and confirm it
/ ,	Define whether the number is a mobile phone number or a landline number and confirm it

Deleting phone numbers from the redialling list

	Open the redialling list
/ ,	Select an entry and confirm it
/ , Delete	Select the submenu and confirm it

Deleting the entire redialling list

	Open the redialling list
	Open the menu
/ , Delete all	Select the submenu and confirm it
Confirm? , Empty	Confirm the deleting process

Operation

or

, or Cancel the deleting process

Dialling phone numbers from the redialling list

Page 120

Call list

All incoming calls received in your absence are recorded in a call list. The call list can contain up to 40 phone numbers. The time and date of receipt are recorded for each call.

When the call list is open, the icon appears in the display.

The last call received appears at the top of the call list.

If calls have been received in your absence, the visual call indicator flashes and the icon appears in the display. Until the call list is actually opened, the display also indicates how many calls have been received.

Displaying numbers in the call list

, / Open the call list and select an entry

Storing a phone number in the call list in the phone book

A phone number in the call list can be stored in the phone book directly.

, / Open the call list and select an entry

Open the menu

/ **Save Number** , Select the submenu and confirm it

Enter name Enter the name (max. 12 characters) and confirm it

Enter Number Edit the phone number if necessary (max. 24 digits) and confirm it

/ , Define whether the number is a mobile phone number or a landline number and confirm it

Deleting phone numbers in the call list

Deleting individual phone numbers

, / Open the call list and select an entry

Open the menu

/ **Delete** , Select the submenu and confirm it

Deleting all phone numbers

Open the call list

Open the menu

/ , **Delete all** , Select the submenu and confirm it

Confirm? , **Empty** Confirm the deleting process

or

Confirm?

[R] or 

Cancel the deleting process

Calling back calls received

 Page 120

Acoustic and visual settings

You can define various settings in order to adapt the telephone to your specific needs:

Setting the ringing tone

It is recommended to set different ringing tones to distinguish between internal and external calls. There are a total of 12 polyphone ringing tones available.

Setting the ringing tone;  Menu, Page 117

Key tones

The key tones provide confirmation that a button has actually been pressed. The phone can be set-up so that the same tone is issued regardless of the button pressed (Setting: Tone) or different key tones are produced (Setting: Melody). It is also possible to switch the key tone function off.

Setting the key tones;  Menu, Page 117

Acoustic warning signal, battery capacity

The acoustic warning signal alerts you to the fact that the battery capacity is low.

Setting the battery capacity acoustic warning signal; (Low batt);  Menu, Page 117

Acoustic warning signal, range

The acoustic warning signal alerts you to the fact that the handset is out of range of the base station.

Setting the range acoustic warning signal (Out-of-range);  Menu, Page 117

Equalizer

You can adapt the tone of the loudspeaker to your individual needs. You can leave the tone in its Natural setting or increase the Bass or Treble tone.

Setting the equalizer;  Menu, Page 117

Display contrast

The contrast of the display (LCD contrast) can be set to one of 6 different levels;  Menu, Page 117

Handset name

You can assign individual names to each handset (Handset Name);  Menu, Page 117

Time and date format

You can define the format and the sequence in which the time and date should be displayed;

 Menu, Page 116

Operation

Other settings

Automatic answering

If this function is activated, an incoming call is taken when the handset is removed from the base/charging station. The automatic answering function is activated and deactivated using the menu.



Activating automatic answering;  Men, Page 117

Key lock

If this setting is activated, the key lock function is automatically enabled when no button has been pressed for a period of 90 seconds. When the key lock is activated, the  icon appears in the display.

Activating the key lock;  Menu, Page 117

Prefix number

You can store a prefix number (Prefix). By pressing and holding the  button before or after entering a phone number, the prefix number is set to precede the phone number. Press the  button to dial this number.

Changing the prefix;  Menu, Page 118

Changing the PIN

The PIN code is required in order to register handsets. The PIN set at the factory is "0000".

Changing the PIN;  Menu, Page 118

Reset

This function enables you to reset the phone to its default settings defined at the factory.

Reset;  Menu, Page 118

Searching for the handset (Paging)

If you have mislaid your handset, you can sound a paging tone to find it.



Conditions: The handset is switched on and is within range of the base station. The batteries are not empty.



Start the paging tone



Stop the paging tone

Special functions

Alarm clock

The "Alarm clock" function can be used so that you are woken or alerted by the handset at a specific time. When the alarm clock function is activated, the  icon appears in the display. The selected tone is played for 1 minute at the set time. The message **Alarm** appears in the display.

Setting the alarm clock function

You can define whether the alarm clock function should only be set for a one-off alert (Once) or whether the alarm should alert you every day at the same time (Daily).



Setting the alarm (Set alarm);  Menu, Page 116

Stopping the alarm prematurely



Stop the alarm

Baby call

Use this function to store a set a specific phone number (max. 24 digits) that will be dialled automatically when any button (except  and ) is pressed.

If the function is switched on, the **Baby call** message flashes continually in the display.

Activating baby call;  Menu, Page 117

Call barring

The call barring function prevents handsets dialling phone numbers which begin with digits previously defined and stored. Up to 4 barring numbers with max. 8 digits can be stored.

Activating call barring;  Menu, Page 118

Emergency call numbers

You can store up to 4 phone numbers which can still be dialled even when the call barring function is activated. Refer to Page 118 for the sequence of menu option selections.

Dialling mode

The handset can be operated in analogue exchanges (pulse dialling mode) as well in newer digital exchanges (tone dialling mode / DTMF). The dialling mode is controlled via the menu. Refer to Page 118 for the sequence of menu option selections.

Caller number display (CLIP)



The caller number display (CLIP) and display of date and time are optional services offered by your telephone network provider. Contact them for any further information.

If the CLIP function is available for your telephone system (CLIP = Calling Line Identification Presentation), the number of the caller appears in the display when a call is received - as long as callers have agreed to transmission of their phone number.



If you do not take a call received, the information remains in the display for approx. 6 seconds before the current time and date reappear.

Extending the Telephone System

7 Extending the Telephone System

The internationally approved **GAP**¹ standard regulates the compatibility of handsets and telephones (base stations) from different manufacturers. As a result, it is possible to integrate SWITEL devices and devices from other manufacturers together in one telephone system. It is possible, however, that some functions are not available.

Multiple handsets

You can register 6 handsets on your telephone (base station).

Registering handsets

Handsets are registered using the menu on the telephone (base station). Refer to Page 118 for the sequence of menu option selections.

Approx. 10 sec. 



To initiate the registration process, press the button until the visual call indicator on the phone flashes.

 /  /  , **Base setting** , 



Open the menu

 /  , **Register** , 

Open the menu

 /  , **Base x** , 

Select the base

PIN?  , 

Enter the PIN² and confirm it

The handset searches for the base station. This process can take up to 2 minutes.

The handset is automatically assigned an internal call number following registration. The internal call number appears in the display.



To register handsets from other manufacturers, please refer to the operating manual supplied with them.

Deregistering handsets



You can only deregister a handset from a telephone (base station) using another handset registered on the telephone (base station).

Handsets are deregistered using the menu on the telephone (base station). Refer to Page 118 for the sequence of menu option selections.

Several base stations

You can increase the range of your handset by registering it on several telephones (base stations). The handset can be registered on up to 4 different telephones (base stations) simultaneously. Each telephone (base station) requires its own telephone connection socket. Connections can be used with the same call number or with different ones.



Calls in progress cannot be transferred from one telephone (base station) to another.

¹ **GAP**: **Generic Access Profile** = Standard for the interoperation of handsets and base stations from different manufacturers.

² The default PIN code is "0000".

8 PBX / Supplementary Services

R-button and supplementary services

Your telephone supports supplementary services provided by your telephone network provider, such as brokering, call waiting and conference facilities. Press the **(R)** button to use these supplementary services. Please contact your telephone network provider regarding which Recall (Flash) time must be set to use the supplementary services. Also contact your telephone network provider with regard to enabling supplementary services. The Recall time is set using the menu. Refer to Page 118 for the sequence of menu option selections.

R-button on private branch exchanges

If the telephone is connected to a private branch exchange, functions such as transferring calls and automatic call back can be used via the **(R)** button. Refer to the operating manual provided with your private branch exchange as to which Recall (Flash) time must be set in order to use these functions. The sales outlet where you purchased the exchange can provide information as to whether the telephone will work properly with the exchange. The Recall time is set using the menu. Refer to Page 118 for the sequence of menu option selections.

Number for an outside line (access code)

When using private branch exchanges, it is necessary to dial an access code to obtain the dialling tone for an outside line. The number for an outside line is often "0" or "9". Dial this number first and wait for the dialling tone. You can then dial the actual phone number.



If one-touch dialling buttons are to be used when the phone is connected to a private branch exchange, please take this into consideration and enter the access code before the actual phone number when programming the one-touch dialling buttons.

It is also possible to program a dialling pause between the number for an outside line and the actual phone number, see Section "Dialling pause".

Dialling pause

When using private branch exchanges, it is necessary to dial an access code to obtain the dialling tone for an outside line. When using some older private branch exchanges, it takes a little time before the dialling tone becomes audible. In the case of such private branch exchanges, a dialling pause can be inserted after the number for an outside line in order to continue dialling directly without having to wait for the dialling tone. The dialling pause is inserted by pressing and holding the **(**)** button for 3 seconds.

The actual phone number is dialled a certain time after the number for an outside line.



The dialling pause can also be entered for the phone numbers in the phone book.

PBX / Supplementary Services

Caller number display (CLIP¹)



The caller number display (CLIP) is a supplementary service offered by your telephone network provider. Contact your network provider for further information.

If this function is available with your telephone line, the number of the caller appears in the display when the phone rings. If the caller has suppressed transmission of their phone number, the corresponding message appears in the display. The phone number is not displayed and, as a result, is not stored in the call list.

Answering machine in the telephone network

An answering machine in the telephone network is a supplementary service offered by many telephone network providers. If your telephone network provider offers an answering machine in the telephone network for you, an icon in the display informs you of new messages received (**VMWI**²). This function can only be used when your telephone network provider actually offers the service. Contact your network provider for further information.

¹ **CLIP**: Calling Line Identification Presentation = Displays the caller's phone number.

² **VMWI**: Visual Message Waiting Indication = Visual indicator that new messages have been recorded.

9 Technical Properties

Feature	Value
Standard	DECT ¹ -GAP ²
Power supply (base station)	Input: 100-240 V, 50-60 Hz Output: 6 V, 500 mA
Range	Outdoors: Approx. 300 m Indoors: Approx. 50 m
Standby time	Up to 110 h
Max. talk time	Up to 11 h
Max. receiver volume	30 dB
Rechargeable batteries	2 x 1.2 V 500 mAh NiMH, Size: AAA
Dialling mode	Tone dialling mode (DTMF) Pulse dialling mode
Recall (Flash) time	Short, Medium, Long
Number of ringing melodies	12 (polyphone)
Max. number of phone book entries	50
Max. number of call list entries	40
Max. number of redialling list entries	5
Menu languages	German, French, Italian, English, Spanish, Portuguese, Dutch, Polish, Turkish

Declaration of Conformity

This device fulfils the requirements stipulated in the EU directive:

1999/5/EC directive on radio equipment and telecommunications terminal equipment and the mutual recognition of their conformity. Conformity with the above mentioned directive is confirmed by the CE mark on the device.



Service hotline

Should problems arise with the telephone, please refer to the following information first. In the case of technical problems, you can contact our hotline service, Tel. 0900 00 1675 within Switzerland (Swisscom fees at time of going to print: CHF 2.60/min). In the case of claims under the terms of guarantee, please contact your sales outlet. There is a 2 year period of guarantee.

¹ DECT: Digital Enhanced Cordless Telecommunication = Standard for cordless telephones.

² GAP: Generic Access Profile = Standard for the interoperation of handsets and base stations from different manufacturers.

In Case of Problems

10 In Case of Problems

Problems	Solutions
No telephone calls possible	<ul style="list-style-type: none">- The telephone or base station is not connected properly or is defective. Only use the telephone connection cable supplied.- The power adapter plug is not plugged in or there is a complete power failure.- Test whether the telephone connection is in order by using another telephone.- Telephone (base station) has been positioned in an unfavourable location.- The rechargeable batteries are empty or defective.- The handset is too far from the base station.- The wrong dialling mode is set; ☞ Page 118.- If several handsets are registered: A call is in progress on another handset.- In the case of internal phone calls: The handset called is out of range of the base station.- The key lock is activated.- The handset is not switched on.
No connection possible to the telephone (base station)	<ul style="list-style-type: none">- Check that the handset has been registered on the telephone (base station) with the correct PIN code; ☞ Page 118.
Connection is disturbed or cut off	<ul style="list-style-type: none">- The handset is too far from the base station.- Telephone (base station) has been positioned in an unfavourable location.
Acoustic signals can be heard during a phone call	<ul style="list-style-type: none">- The handset is too far from the base station.- The rechargeable batteries are almost empty.
The system no longer responds	<ul style="list-style-type: none">- Reset all functions to their default settings; ☞ Page 118.- Briefly disconnect the power adapter plug from the power socket.
The batteries are empty within a short time	<ul style="list-style-type: none">- The batteries are empty or defective.- Place the handset in the base/charging station properly. Clean the contact surfaces on the handset and base/charging station with a soft, dry cloth.- Place the handset in the base/ charging station for 8 hours.
The batteries can no longer be charged	<ul style="list-style-type: none">- The batteries are defective.
The caller number display (CLIP) does not function	<ul style="list-style-type: none">- The caller number display (CLIP) is a supplementary service offered by your telephone network provider. Contact your network provider for further information.- The caller has suppressed the transmission of their phone number.

11 Maintenance / Guarantee

Maintenance

- Clean the housing surfaces with a soft, fluff-free cloth.
- Do not use any cleaning agents or solvents.

Apart from occasionally cleaning the housing, no other upkeep is necessary.

Guarantee

SWITEL equipment is produced and tested according to the latest production methods. The implementation of carefully chosen materials and highly developed technologies ensure trouble-free functioning and a long service life. The terms of guarantee do not apply where the cause of equipment malfunction is the fault of the telephone network operator or any interposed private branch extension system. The terms of guarantee do not apply to the batteries or power packs used in the products. The period of guarantee is 24 months from the date of purchase.

All deficiencies related to material or manufacturing errors within the period of guarantee will be redressed free of charge. Rights to claims under the terms of guarantee are annulled following tampering by the purchaser or third parties. Damage caused as the result of improper handling or operation, normal wear and tear, incorrect positioning or storage, improper connection or installation or Acts of God and other external influences are excluded from the terms of guarantee. In the case of complaints, we reserve the right to repair defective parts, replace them or replace the entire device. Replaced parts or devices become our property. Rights to compensation in the case of damage are excluded where there is no evidence of intent or gross negligence by the manufacturer.

If your device does show signs of a defect within the period of guarantee, please contact the sales outlet where you purchased the SWITEL device, producing the purchase receipt as evidence. All claims under the terms of guarantee in accordance with this agreement can only be asserted at the sales outlet. No claims under the terms of guarantee can be asserted after a period of two years from the date of purchase and hand-over of the product.

12 Index

A

- Access code, 131
- Acoustic and visual settings, 127
- Acoustic warning signal, battery capacity, 127
- Acoustic warning signal, range, 127
- Adjusting the ringing volume, 122
- Alarm clock, 129
- Answering machine
 - in the telephone network, 132
- Automatic answering, 128

B

- Baby call, 129
- Base station, 112
- Batteries, 107, 133
- Battery charge status, 109
- Brokering, 121

C

- Call barring, 129
- Call list, 126
- Callback , 120
- Caller number display, 126, 132
- Caller number display (CLIP), 129
- Calling back calls received, 120, 127
- Calls missed, 126
- Changing the PIN, 128
- Charging the batteries, 109
- Checking the phone book capacity, 125
- Cleaning, 135
- CLIP, 129, 132
- Conference calls, 121
- Connecting the base station, 108
- Creating, 114
- Creating phone book entries, 123

D

- Deactivating the microphone, 123
- Declaration of Conformity, 133
- DECT, 133
- Deleting all entries, 124
- Deleting all phone numbers, 126
- Deleting an entry, 124
- Deleting individual phone numbers, 126
- Deleting phone book entries, 124
- Deleting phone numbers
 - from the redialling list, 125
- Deleting phone numbers in the call list , 126
- Deleting the redialling list, 125
- Deregistering, 130
- Deregistering handsets, 130
- Dialling, 120
- Dialling mode, 129, 133
- Dialling pause, 131
- Dialling phone numbers
 - from the redialling list, 126
- Display, 111
- Display contrast, 127
- Display icons, 111
- Disposal, 107
- Duration of call, 133

E

- ECO mode, 109
- Editing phone book entries, 124
- Emergency calls, 129
- Ending a call, 119
- Entering names, 123
- Entering text, 123
- Equalizer, 127
- Extending the telephone system, 130

F

- Flash time, 133
- Forwarding calls, 121

G

- GAP, 133
- Guarantee, 135

H

- Handset, 110
- Handset name, 127
- Handsfree, 122
- Hearing aid compatibility, 107
- Holding a call, 121

I

- Icons, 111
- Inserting the batteries, 109
- Installation location, 106
- Intended use, 106
- Internal calls, 120

K

- Key lock, 119, 128
- Key tones, 127

L

- Low-radiation, 109

M

- Main menu, 115
- Maintenance, 135
- Making a call, 119
- Medical equipment, 107
- Menu guidance, 113
- Menu languages, 133
- Menu structure, 115
- Multiple handsets , 130
- Muting function, 123

N

- No. of call list entries, 133
- No. of phone book entries, 133
- No. of redialling list entries, 133
- Notation, 113

O

- One-touch dialling, 120
- Operating elements, 110
- Operation, 119

P

- Package contents, 108
- Paging, 128
- Phone book, 120, 123
- Phone book entries, 114
- Power adapter plug, 106
- Power failure, 106
- Power supply, 133
- Prefix number, 128
- Private branch exchanges, 109, 131
- Problems, 134
- Programming one-touch dialling buttons, 125
- Putting the handset into operation, 108

R

- R-button, 131
- Range, 133
- Receiver volume, 133
- Redialling, 120
- Redialling list, 125
- Registering, 130
- Registering handsets, 130
- Reset, 128
- Ringing tones, 133

Index

S

- Safety information, 106
- Saving, 114
- Saving a number in the redialling list in the phone book, 125
- Searching for the handset, 128
- Service hotline, 133
- Setting the alarm clock, 129
- Setting the date, 109
- Setting the display language, 109
- Setting the receiver volume, 122
- Setting the ringing tone, 127
- Setting the time, 109
- Several base stations, 130
- Special functions, 129
- Standby mode, 113
- Standby time, 133
- Starting Up, 108
- Stopping the alarm prematurely, 129
- Storing, 126
- Supplementary services, 131
- Switching the ringing tone on and off , 122
- Switching the telephone off, 119
- Switching the telephone on, 119

T

- Taking a call, 119
- Taking external calls when an internal call is in progress, 121
- Talk time, 122
- Telephoning, 119
- Time and date format, 127
- Transferring calls, 121
- Transferring external calls internally, 121

V

- VMWI, 132

Important note

The telephone base station is equipped with an energy-efficient switching power supply (input 100~240 V_{AC}, output 6 V_{DC}, 500 mA). The zero load is approx. 0.15 W. The average efficiency is 71%. The power consumption of the base station max. 0,78 W.

The charging unit(s) supplied with the telephone set is/are equipped with an energy-efficient switching power supply (input 100~240 V_{AC}, output 6 V_{DC}, 150 mA). The zero load is approx. 0.17 W. The average efficiency is 67%. The power consumption of the charging station max. 0.22 W.

SWITEL

Declaration of Conformity



This equipment complies with the European R&TTE directive.
To view the complete Declaration of Conformity, please refer to the free
download available at our web site: www.switel.com.

Service Hotline

In the event of technical problems, you can contact our hotline service, Tel. 0900 00 1675 within Switzerland (cost via Swisscom at time of going to print: CHF 2.60/min).