

SWITEL

SWISS BRAND 

**Strahlungsarmes schnurloses DECT-GAP-Telefon
mit Anrufbeantworter**

**Téléphone DECT/GAP sans fil, à faible rayonnement
et avec répondeur**

**Telefono cordless DECT/GAP a basse radiazioni
con segreteria telefonica**

**Low-radiation cordless DECT/GAP telephone
with answering machine**



DFT 147x

Bedienungsanleitung
Mode d'emploi
Istruzioni per l'uso
Operating Instructions

D

F

I

GB

SWITEL

DFT 147x

Bedienungsanleitung	3
Mode d'emploi	37
Istruzioni per l'uso	71
Operating Instructions	105
Declaration of Conformity	136

1	Sicherheitshinweise	4
2	Telefon in Betrieb nehmen	5
3	Bedienelemente	8
4	Einführende Informationen	9
5	Telefonieren	12
6	Weitere Leistungsmerkmale	16
7	Anrufliste / Wahlwiederholung	17
8	Telefonbuch	18
9	Telefon einstellen	19
10	Anrufbeantworter	24
11	Mobilteile an-/abmelden	29
12	Betrieb an Telefonanlagen / Zusatzdienste	30
13	Menüstruktur	31
14	Fehlersuche	33
15	Technische Daten	35
16	Garantie	36

1 Sicherheitshinweise

Lesen Sie diese Bedienungsanleitung sorgfältig durch.

Bestimmungsgemäße Verwendung

Dieses Telefon ist geeignet zum Telefonieren innerhalb eines Telefonnetzes. Jede andere Verwendung gilt als nicht bestimmungsgemäß. Eigenmächtige Veränderungen oder Umbauten sind nicht zulässig. Öffnen Sie das Gerät in keinem Fall selbst und führen Sie keine eigenen Reparaturversuche durch.

Aufstellungsort

Vermeiden Sie Belastungen durch Rauch, Staub, Erschütterungen, Chemikalien, Feuchtigkeit, Hitze oder direkte Sonneneinstrahlung. Verwenden Sie das Mobilteil nicht in explosionsgefährdeten Bereichen.

Netzteil



Achtung: Verwenden Sie nur das mitgelieferte Steckernetzteil, da andere Netzteile das Telefon beschädigen können. Sie dürfen den Zugang zum Steckernetzteil nicht durch Möbel oder andere Gegenstände versperren.

Aufladbare Akkus



Achtung: Werfen Sie Akkus nicht ins Feuer. Verwenden Sie nur Akkus des gleichen Typs! Achten Sie auf die richtige Polung! Bei verkehrter Polung der Akkus besteht beim Aufladen Explosionsgefahr.

Stromausfall

Bei Stromausfall kann mit diesem Telefon nicht telefoniert werden. Halten Sie für Notfälle ein schnurgebundenes Telefon bereit, welches ohne externe Stromversorgung arbeitet.

D

Medizinische Geräte



Achtung: Benutzen Sie das Telefon nicht in der Nähe von medizinischen Geräten. Eine Beeinflussung kann nicht völlig ausgeschlossen werden.

DECT¹-Telefone können in Hörgeräten einen unangenehmen Brummtönen verursachen.

¹DECT: Digital Enhanced Cordless Telecommunication = Standard für kabellose Telefone.

Entsorgung

Wollen Sie Ihr Gerät entsorgen, bringen Sie es zur Sammelstelle Ihres kommunalen Entsorgungsträgers (z. B. Wertstoffhof). Nach dem Elektro- und Elektronikgerätegesetz sind Besitzer von Altgeräten gesetzlich verpflichtet, alte **Elektro- und Elektronikgeräte** einer getrennten Abfallerfassung zuzuführen. Das nebenstehende Symbol bedeutet, dass Sie das Gerät auf keinen Fall in den Hausmüll werfen dürfen!



Gefährdung von Gesundheit und Umwelt durch Akkus und Batterien!



Akkus und Batterien nie öffnen, beschädigen, verschlucken oder in die Umwelt gelangen lassen. Sie können giftige und umweltschädliche Schwermetalle enthalten. Sie sind gesetzlich verpflichtet, Akkus und Batterien beim batterievertreibenden Handel sowie bei zuständigen Sammelstellen, die entsprechende Behälter bereitstellen, sicher zu entsorgen. Die Entsorgung ist unentgeltlich. Die Symbole bedeuten, dass Sie Akkus und Batterien auf keinen Fall in den Hausmüll werfen dürfen und sie über Sammelstellen der Entsorgung zugeführt werden müssen.

Verpackungsmaterialien entsorgen Sie entsprechend den lokalen Vorschriften.

2 Telefon in Betrieb nehmen

Sicherheitshinweise



Achtung: Lesen Sie vor der Inbetriebnahme unbedingt die Sicherheitshinweise in Kapitel 1.

Verpackungsinhalt prüfen

Zum Lieferumfang gehören:

Inhalt	DFT 147X-Modell			
	DFT 1471	DFT 1472 ¹	DFT 1473 ¹	DFT 1474 ¹
Basisstation mit Netzteil	1	1	1	1
Ladestation mit Netzteil	-	1	2	3
Mobilteil	1	2	3	4
Telefonanschlusskabel	1	1	1	1
Akkupack	1	2	3	4
Bedienungsanleitung	1	1	1	1

Stromverbrauch

Die **Leistungsaufnahme der Basisstation** beträgt:

- im Betrieb (Bereitschaft/Gespräch): ca. 1,5 W

- während der Ladung des Mobilteils: ca. 2,5 W.

Die Nulllast des Netzteils beträgt ca. 0,15 W.

Die durchschnittliche Effizienz beträgt ca. 65 %.

Die durchschnittliche Effizienz beträgt ca. 65 %.

Die **Leistungsaufnahme der Ladestation** beträgt:

- ohne Mobilteil: ca. 0,15 W

- während der Ladung des Mobilteils: ca. 1,2 W.

Die Nulllast des Netzteils beträgt ca. 0,15 W.

Die durchschnittliche Effizienz beträgt ca. 60 %.

Basisstation anschließen



Achtung: Stellen Sie die Basisstation mit einem Mindestabstand von 1 m zu anderen elektronischen Geräten auf, da es sonst zu gegenseitigen Störungen kommen kann.

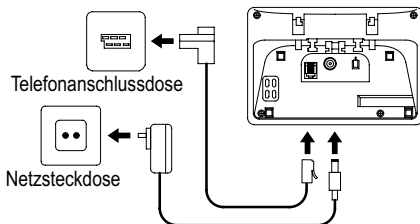

Schließen Sie die Basisstation wie auf der Skizze abgebildet an. Verwenden Sie aus Sicherheitsgründen nur das mitgelieferte Netzteil sowie das beigelegte Telefonanschlusskabel.



Achtung: Verwenden Sie für die Basisstation nur das mitgelieferte Netzteil.

Akkupack einlegen

Schieben Sie den Akkufachdeckel abwärts und nehmen Sie ihn anschließend ab. Stecken Sie den Stecker des Akkupacks in die Buchse im Akkufach. Legen Sie das Akkupack in das Akkufach ein. Verwenden Sie nur das mitgelieferte Akkupack. Achten Sie darauf, dass Sie das Kabel nicht ein-klemmen. Setzen Sie den Deckel wieder auf das Akkufach und schieben Sie ihn nach oben, bis er einrastet.

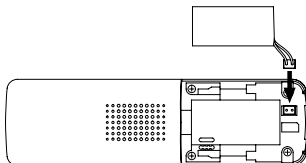

Akkupack aufladen



Stellen Sie das Mobilteil bei der ersten Inbetriebnahme für **mindestens** 15 Stunden in die Basisstation / Ladestation.

Das Mobilteil erwärmt sich beim Laden. Dies ist normal und ungefährlich. Laden Sie das Mobilteil nicht mit fremden Aufladegeräten. Der Akkuladestandard wird im Display angezeigt. Wenn die Ladung des Akkupacks die untere Grenze erreicht hat, blinkt das Akkusymbol im Display.

Datum und Uhrzeit des Mobilteils einstellen

Bei Inbetriebnahme verfügt das Mobilteil nicht über eine korrekte Uhrzeit (z. B. für Einträge in der Anrufliste/Anrufbeantworter). Datum und Uhrzeit stellen Sie über den Menüpunkt **Uhrzeit/Alarm > Datum/Zeit** ein.

Displaysprache einstellen

Die Displaysprache ist in 4 verschiedenen Sprachen einstellbar. Im Auslieferungszustand ist „Deutsch“ eingestellt. Sie können die Sprache über den Menüpunkt **MT einstellen > Sprache** ändern.

Automatische Rufannahme / Direktannahme

Ist die Funktion aktiviert (Auslieferungszustand), wird ein Anruf automatisch beim Herausnehmen des Mobilteils aus der Basisstation angenommen. Die automatische Anrufannahme wird über den Menüpunkt **MT einstellen > Direktannahme** ein- oder ausgeschaltet.

3 Bedienelemente

Die Tasten Ihres Telefons werden in dieser Bedienungsanleitung nachfolgend mit vereinheitlichten umrandeten Symbolen dargestellt. Leichte Abweichungen der Tastensymbole Ihres Telefons gegenüber den hier verwendeten Tastensymbolen sind daher möglich.

Mobilteil

- 1 Hörkapsel
- 2 Display
- 3 Lautstärke + /
Navigationstaste aufwärts
- 4 Softkey-Taste rechts
- 5 Anrufliste /
Navigationstaste rechts
- 6 Auflegetaste /
Ausschalten
- 7 Wahlwiederholung /
Lautstärke - /
Navigationstaste abwärts
- 8 #-Taste / Tonruf aus
- 9 Flash-Taste
- 10 Interngespräche
- 11 Mikrofon
- 12 Freisprechtaste
- 13 *-Taste /
Tastensperre
- 14 Zifferntastenblock
- 15 Abnehmetaste
- 16 Navigationstaste links
- 17 Softkey-Taste links

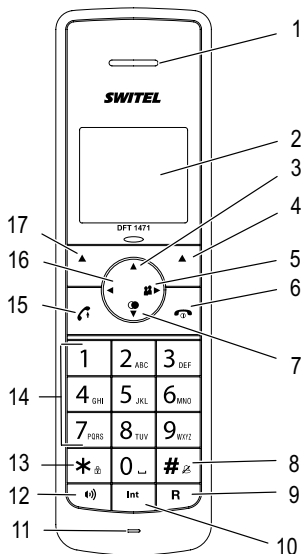

Basisstation



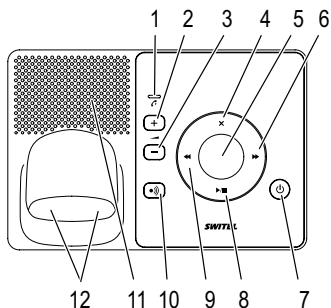





- 1 LED: Gesprächsanzeige
- 2 Lautstärke + 
- 3 Lautstärke - 
- 4 Löschen 
- 5 Display
- 6 Nächste Nachricht 
- 7 Anrufbeantworter ein / aus 
- 8 Wiedergabe/Stop 
- 9 Nachricht wiederholen / Vorherige Nachricht 
- 10 Mobilteil suchen (Paging) 
- 11 Lautsprecher
- 12 Ladkontakte



4 Einführende Informationen

In diesem Kapitel finden Sie grundlegende Informationen zur Handhabung der Bedienungsanleitung und des Telefons.

Darstellungsweise in der Bedienungsanleitung

	Abgebildete Taste drücken
2 Sek. 	Abgebildete Taste 2 Sekunden drücken
	Nummern oder Buchstaben eingeben
	Mobilteil klingelt
	Basisstation klingelt
	Mobilteil aus der Basisstation nehmen
	Mobilteil in die Basisstation stellen
Alarm	Darstellung von Display-Texten
	Darstellung von Display-Symbolen





Symbole im Display des Mobilteils

Symbol	Beschreibung
	Konstant: Verbindung zur Basisstation. Blinkend: Keine Verbindung zur Basisstation.
	Konstant: Anzeige der Akkukapazität. Durchlaufend während Mobilteil in der Basis: Der Akku wird geladen.
TT-MM	Anzeige des Datums ☞ Seite 19.
SS:MM	Anzeige der Uhrzeit ☞ Seite 19.
	Freisprechbetrieb ist aktiviert.
	Konstant: Ein Alarm ist eingestellt. Blinkt: Die eingestellte Alarmzeit ist erreicht. ☞ Seite 19.
	Konstant: Sie führen ein Gespräch. Blinkend: Sie erhalten gerade einen Anruf.
	Sie führen ein Interngespräch (nur bei mehreren Mobilteilen an einer Basis) ☞ Seite 14. Eintreffendes Interngespräch.
	Während Anzeige der Anrufliste: Neuer Anruf. Während Abspielen der Nachrichten vom Anrufbeantworter: Neue Nachricht.
	Tastensperre ist aktiviert ☞ Seite 16.
Mikrofon aus	Das Mikrofon ist stummgeschaltet ☞ Seite 14.
	Tonruf ist ausgeschaltet ☞ Seite 16.
	Der Anrufbeantworter ist eingeschaltet ☞ Seite 25.



In der unteren Displayzeile werden zugehörig zu den beiden **Softkeys** die abhängig vom Betriebszustand verfügbaren Funktionen angezeigt.

Menü	Aufruf des Menüs.
TB	Aufruf des Telefonbuchs.
Wähle	Auswahl des markierten Menüpunkts / Eintrags.
Ok	Bestätigung einer Einstellung.
Zurück	Zurück zum übergeordneten Menü bzw. Abbruch der Programmierung.
Lösche	Rückwärts-Löschen von Zeichen bei der Eingabe (kurzer Druck löscht letztes Zeichen, langer Druck die ganze Zeile).

Funktionen der Navigationstaste

	Im Menü / in Listen (Telefonbuch, Anrufliste, Wahlwiederholung): Blättern aufwärts. Während eines Gesprächs: Lautstärke erhöhen.
	Während Bearbeitung von Einträgen / bei Wahlvorbereitung: Cursor nach links bewegen.
	Im Bereitschaftszustand: Anrufliste öffnen. Während Bearbeitung von Einträgen / bei Wahlvorbereitung: Cursor nach rechts bewegen.
	Im Bereitschaftszustand: Wahlwiederholungsliste öffnen. Während eines Gesprächs: Lautstärke verringern. Im Menü / in Listen (Telefonbuch, Anrufliste, Wahlwiederholung): Blättern abwärts.

Sonderfunktionen einiger Tasten

	Bei der Rufnummereingabe: langer Druck gibt eine Wahlpause ein.
	Im Bereitschaftszustand: langer Tastendruck schaltet Tastensperre ein/aus. Bei Namenseingaben: langer Tastendruck schaltet den Zeichensatz um (Lateinisch/Russisch/Griechisch), Tabellen siehe Anhang. Während einer Verbindung: temporäre Umschaltung auf Tonwahl, wenn Impulswahl eingeschaltet.

#

Im Bereitschaftszustand: langer Tastendruck schaltet Mobilteil-Tonruf ein/aus.

Bei Namenseingaben: langer Tastendruck schaltet zwischen Groß- und Kleinschreibung um.

Bereitschaftsmodus



Alle Beschreibungen in dieser Bedienungsanleitung gehen davon aus, dass sich das Mobilteil im Bereitschaftsmodus befindet. Den Bereitschaftsmodus erreichen Sie, indem Sie die Taste  drücken.

Strahlungsreduzierung (ECO-Mode)

Sowohl im Gesprächs- als auch im Bereitschaftsmodus wird die Strahlung bei eingeschaltetem ECO-Mode im Vergleich zu Standard-DECT-Schnurlostelefonen erheblich verringert.



Navigation im Menü



Alle Funktionen sind über unterschiedliche Menüs zu erreichen. Die komplette Menüstruktur finden Sie im Anhang. Zur Navigation im Menü benutzen Sie die Softkeys und die Navigationstaste. Mit dem linken Softkey **Menü** öffnen Sie das Menü. Mit den Navigationstasten  bzw.  bewegen Sie sich im Menü. Zum Öffnen eines Untermenüs drücken Sie den Softkey **Wähle**. Wollen Sie zum übergeordneten Menü zurück, drücken Sie **Zurück**. Durch Drücken der Auflegetaste  gelangen Sie wieder in den Bereitschaftsmodus.

5 Telefonieren

Anruf annehmen

  Ihr Telefon klingelt.

Befindet sich das Mobilteil **nicht** in der Basis:

 /  Drücken Sie die Abnehmetaste oder die Freisprechtaste.

Befindet sich das Mobilteil in der Basis und **Direktannahme** ist nicht eingeschaltet:

 /  Nehmen Sie das Mobilteil aus der Basis und drücken Sie die Abnehmetaste oder die Freisprechtaste.

Befindet sich das Mobilteil in der Basis und **Direktannahme** ist eingeschaltet:

 Nehmen Sie einfach das Mobilteil aus der Basis; das Gespräch wird automatisch angenommen.

Anrufen



Geben Sie die Rufnummer ein. Fehler bei der Eingabe mit **Lösche** korrigieren.

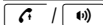

Rufnummer wird gewählt.



Sie können auch zuerst die Abnehmetaste drücken und erhalten damit das Freizeichen. Die eingegebenen Ziffern Ihrer gewünschten Rufnummer werden sofort gewählt. Eine Korrektur einzelner Ziffern der Rufnummer ist bei dieser Form des Gesprächsaufbaus nicht möglich.

Gespräch beenden



Auflegetaste drücken oder Mobilteil in die Basis stellen.

Wahlwiederholung



Ihr Telefon speichert die 10 zuletzt gewählten Rufnummern. Ist für die Rufnummer ein Telefonbucheintrag angelegt, wird der Name angezeigt.



Öffnen Sie die Wahlwiederholungsliste.



Wählen Sie einen Eintrag aus.

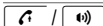

Rufnummer wird gewählt.

Aus der Anrufliste anrufen



Ihr Telefon speichert die letzten 20 Anrufe in der Anrufliste. Ist für die Rufnummer ein Telefonbucheintrag angelegt, wird der Name angezeigt. Um die zugehörige Rufnummer anzuzeigen, drücken Sie **Wähle**.

Die Speicherung kann nur erfolgen, wenn die Funktion „Rufnummernübertragung (CLIP)“ an Ihrem Anschluss verfügbar ist und die Rufnummer vom Anrufer nicht unterdrückt oder aus anderen Gründen nicht übertragen wurde.



Öffnen Sie die Anrufliste.



Wählen Sie einen Eintrag aus.

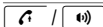

Rufnummer wird gewählt.

Aus dem Telefonbuch anrufen



Das Telefonbuch kann 50 Einträge aufnehmen. Zum Anlegen von Einträgen siehe Abschnitt „Telefonbuch“.

TB

Öffnen Sie das Telefonbuch.



Wählen Sie einen Eintrag aus.

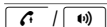

Rufnummer wird gewählt.

Anzeige der Gesprächsdauer

Während eines Gesprächs wird die Gesprächsdauer in Stunden, Minuten und Sekunden angezeigt.

Hörer-/Lautsprecherlautstärke einstellen

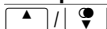

Sie können während eines Gesprächs die Lautstärke in 5 Stufen einstellen (bei Hörerbetrieb -> Hörerlautstärke, bei Freisprechen -> Lautsprecherlautstärke). Die Einstellungen sind getrennt voneinander und bleiben auch nach Ende des Gesprächs gespeichert.

Mikrofon ausschalten (Mute)

Stumm

Sie können während eines Gesprächs das Mikrofon ausschalten, so dass Ihr Gesprächspartner Sie nicht hören kann. Im Display wird **Mikrofon aus** angezeigt.

Mik.an

Zum Einschalten des Mikrofons drücken Sie den Softkey erneut.

Intern telefonieren







Interne Gespräche, Vermitteln und Konferenzgespräche sind nur möglich, wenn mehrere Mobilteile angemeldet sind. Ist dies nicht der Fall, wird im Display **Nicht Verfügbar** angezeigt.



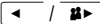

Int

Drücken Sie die Taste **Int**. Sind zwei Mobilteile angemeldet, wird das andere Mobilteil sofort gerufen. Bei mehreren angemeldeten Mobilteilen werden deren interne Nummer angezeigt (z. B. 2 3 4). Wählen Sie mit der Navigationstaste **◀ / ▶** das gewünschte Mobilteil aus und drücken Sie **Wähle**. Wählen Sie "9", werden alle angemeldeten gleichzeitig gerufen.



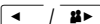

Externes Gespräch vermitteln

	Während eines Externgesprächs...
	Drücken Sie die Taste  . Wählen Sie ggf. mit der Navigationstaste  das gewünschte Mobilteil aus und drücken Sie Wähle . Das externe Gespräch wird gehalten. Wenn das gerufene Mobilteil eingeschaltet wird, ggf. Gespräch ankündigen.
	Drücken Sie die Auflegetaste. Das Gespräch ist übergeben.

Makeln

	Während eines Externgesprächs...
	Drücken Sie die Taste  . Wählen Sie ggf. mit der Navigationstaste  das gewünschte Mobilteil aus und drücken Sie Wähle . Das externe Gespräch wird gehalten.
	Mit der Taste  schalten Sie zwischen den Gesprächspartnern hin und her.

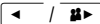
Konferenz

	Während eines Externgesprächs...
	Drücken Sie die Taste  . Wählen Sie ggf. mit der Navigationstaste  das gewünschte Mobilteil aus und drücken Sie Wähle . Das externe Gespräch wird gehalten.
	Drücken und halten Sie die Taste  bis Konferenz im Display erscheint .



Legt einer der beteiligten Konferenzteilnehmer auf, bleiben die beiden anderen miteinander verbunden.

6 Weitere Leistungsmerkmale

Tastensperre



Die Tastensperre verhindert ein unbeabsichtigtes Betätigen der Tasten. Eintreffende Anrufe können wie gewohnt entgegengenommen werden.

*

Drücken und halten Sie die Stern-Taste, bis im Display das Symbol für die Tastensperre erscheint. Zum Entsperren der Tastatur drücken und halten Sie die Raute-Taste erneut, bis das Symbol wieder erlischt.

*

Zum Entsperren der Tastatur drücken und halten Sie die Stern-Taste erneut, bis das Symbol wieder erlischt.

Tonruf ausschalten



Sie können den Tonruf auch über das Menü **MT einstellen > Tonrufeinstellung > Tonruf lautstärke > ausschalten**.

#

Drücken und halten Sie die Raute-Taste, bis im Display das Symbol für den ausgeschalteten Tonruf erscheint.

#

Zum Wiedereinschalten des Ruftons drücken und halten Sie die Raute-Taste erneut, bis das Symbol wieder erlischt.

Mobilteil ausschalten



Sie können das Mobilteil ausschalten, um den Akku zu schonen.







Drücken Sie die Auflegetaste und halten Sie sie gedrückt. Nach wenigen Sekunden wird das Mobilteil ausgeschaltet. Die Displaybeleuchtung erlischt.







Zum Wiedereinschalten des Mobilteils drücken Sie die Auflegetaste so lange, bis Sie einen Signalton hören und das Display wieder leuchtet.

7 Anrufliste / Wahlwiederholung

Anrufliste bearbeiten

	Öffnen Sie die Anrufliste.
 / 	Wählen Sie einen Eintrag aus und drücken Sie Wähle . Datum und Uhrzeit des Anrufs werden angezeigt.
Menü	Drücken Sie den Softkey Menü .
 / 	Wählen Sie aus den folgenden Möglichkeiten und bestätigen Sie mit Wähle :
In TB speichern	Die Rufnummer wird im Telefonbuch gespeichert. Geben Sie einen Namen ein, bestätigen oder bearbeiten Sie die Rufnummer und legen Sie eine Tonrufmelodie für diesen Eintrag fest.
Löschen	Der Eintrag wird nach einer Sicherheitsabfrage gelöscht.
Alle löschen	Die Liste wird nach einer Sicherheitsabfrage gelöscht.

Wahlwiederholung bearbeiten









	Öffnen Sie die Wahlwiederholung.
 / 	Wählen Sie einen Eintrag aus und drücken Sie Wähle .
Menü	Drücken Sie den Softkey Menü .
 / 	Wählen Sie aus den folgenden Möglichkeiten und bestätigen Sie mit Wähle :
In TB speichern	Die Rufnummer wird im Telefonbuch gespeichert. Geben Sie einen Namen ein, bestätigen oder bearbeiten Sie die Rufnummer und legen Sie eine Tonrufmelodie für diesen Eintrag fest.
Löschen	Der Eintrag wird nach einer Sicherheitsabfrage gelöscht.
Alle löschen	Die Liste wird nach einer Sicherheitsabfrage gelöscht.

8 Telefonbuch







Im Telefonbuch können Sie 50 Rufnummern und zugehörige Namen speichern. Sie können jedem Eintrag eine eigene Melodie zuordnen, mit der ein Anruf signalisiert werden soll. Geben Sie die Rufnummern immer mit der Ortsvorwahl ein; das ermöglicht eine korrekte Anzeige des jeweiligen Anrufers, für den ein Eintrag angelegt ist und dessen Übertragung der Rufnummer an Ihrem Anschluss verfügbar ist.

Neuen Eintrag anlegen

Menü	Drücken Sie den Softkey Menü .
 / 	Wählen Sie Telefonbuch und drücken Sie Wähle .
 / 	Wählen Sie Hinzufügen aus und drücken Sie Wähle .
	Geben Sie den Namen ein (maximal 12 Zeichen). Die Zifferntasten sind mit Buchstaben beschriftet. Durch mehrmaliges Drücken der entsprechenden Taste können Buchstaben und Ziffern eingegeben werden. Zwischen Groß- und Kleinbuchstaben können Sie mit der Raute-Taste (langer Tastendruck) umschalten. Nach kurzer Zeit springt die Einfügemarke (Cursor) weiter. Nach Eingabe des Namens drücken Sie Ok .
	Geben Sie die Rufnummer ein (maximal 24 Ziffern). Ist Ihr Telefon an einer Telefonanlage angeschlossen, geben Sie die Amtskennziffer mit ein. Ist eine Wahlpause erforderlich, drücken Sie nach der Amtskennziffer die Taste 0 für ca. 2 s.; im Display wird P angezeigt. Nach der Eingabe der Rufnummer drücken Sie Ok .
 / 	Wählen Sie eine Melodie für den Eintrag aus.
Wähle	Bestätigen Sie mit Wähle .



D Telefonbucheinträge bearbeiten

Menü	Drücken Sie den Softkey Menü .
 / 	Wählen Sie Telefonbuch aus und drücken Sie Wähle .
 / 	Wählen Sie aus den folgenden Möglichkeiten und bestätigen Sie mit Wähle :
Lesen	Alle Einträge werden angezeigt. Blättern Sie zum gewünschten Eintrag. Mit Wähle sehen Sie Name,

	Rufnummer und Melodie. Mit Menü können Sie den Eintrag bearbeiten oder löschen.
Hinzufügen	Sie können einen neuen Eintrag anlegen.
Bearbeiten	Alle Einträge werden angezeigt. Blättern Sie zum gewünschten Eintrag. Nach Wähle können Sie den Eintrag ändern. Löschen Sie Buchstaben und Ziffern mit Lösche , geben Sie mit den Zifferntasten neue Buchstaben und Ziffern ein. Einzelheiten dazu siehe unter "Neuen Eintrag anlegen".
Löschen	Alle Einträge werden angezeigt. Blättern Sie zum gewünschten Eintrag. Nach Wähle wird der Eintrag sofort gelöscht.
Alle löschen	Nach Wähle wird das komplette Telefonbuch nach einer Sicherheitsabfrage gelöscht.
Telbuch-Status	Die aktuelle Belegung wird angezeigt (z. B. 7 / 50 Bel. : 7 von 50 möglichen Einträgen sind vorhanden).

9 Telefon einstellen

Datum/Zeit













Menü	Drücken Sie den Softkey Menü .
	Wählen Sie Uhrzeit/Alarm und drücken Sie Wähle .
	Wählen Sie Datum/Zeit und drücken Sie Wähle .
	Wählen Sie aus den folgenden Möglichkeiten und bestätigen Sie mit Wähle .
Datumsformat	Sie können die Darstellung des Datums einstellen: (TT-MM-JJJJ oder MM-TT-JJJJ).
Zeitformat	Sie können die Darstellung der Zeit einstellen: (24 oder 12 Stunden).
Datum eingeben	Geben Sie mit den Zifferntasten das Datum ein.
Zeit eingeben	Geben Sie mit den Zifferntasten die Uhrzeit ein. Bei Eingabe im 12-h-Format schalten Sie mit der Stern-Taste zwischen "AM" und "PM" um.









Bei einem Stromausfall geht die Einstellung verloren, wenn gleichzeitig das Mobilteil ausgeschaltet ist oder die Akkus leer sind.

Alarm

Menü	Drücken Sie den Softkey Menü .
-------------	---------------------------------------

 / 	Wählen Sie Uhrzeit/Alarm und drücken Sie Wähle .
 / 	Wählen Sie Alarm und drücken Sie Wähle .
 / 	Wählen Sie Alarm ein und drücken Sie Wähle .
	Geben Sie mit den Zifferntasten die Weckzeit ein und drücken Sie Ok .
 / 	Wählen Sie Snooze ein oder Snooze aus und drücken Sie Wähle . Ist Snooze eingeschaltet, bedeutet dies, dass das Wecksignal nach 2 Minuten wiederholt wird, bis diese Funktion durch Drücken und Halten der Auflegetaste beendet wird. Ist Snooze ausgeschaltet, wird das Wecksignal einmalig zur eingestellten Zeit gegeben. Zum Quittieren des Wecksignals drücken Sie eine beliebige Taste.
 / 	Wählen Sie Alarm Melodie und drücken Sie Wähle .
 / 	Wählen Sie eine der angebotenen Melodien aus und drücken Sie Wähle .







Audioeinstellungen für das Mobilteil

Menü	Drücken Sie den Softkey Menü .
 / 	Wählen Sie MT einstellen und drücken Sie Wähle .
 / 	Wählen Sie Audioeinstellung und drücken Sie Wähle .
 / 	Wählen Sie aus den folgenden Möglichkeiten und bestätigen Sie mit Wähle :
FS-Lautstärke	Wählen Sie die Lautstärke für die Wiedergabe im Freisprechbetrieb aus.
Hörerlautstärke	Wählen Sie die Lautstärke für die Hörerlautstärke aus.



Diese Einstellungen können Sie auch während eines Gesprächs einfach mit den Navigationstasten vornehmen (siehe "Telefonieren / Hörer-/Lautsprecherlautstärke einstellen").

D Tonruf für das Mobilteil einstellen

Menü	Drücken Sie den Softkey Menü .
 / 	Wählen Sie MT einstellen und drücken Sie Wähle .
 / 	Wählen Sie Tonrufeinstellung und drücken Sie Wähle .
 / 	Wählen Sie aus den folgenden Möglichkeiten und bestätigen Sie mit Wähle :
Melodie intern	Wählen Sie eine Melodie für die Signalisierung eines internen Anrufes aus.

Melodie extern Wählen Sie eine Melodie für die Signalisierung eines externen Anrufes aus.

Tonruflautstärke Wählen Sie die Lautstärke für den Tonruf aus. Wählen Sie **Tonruf aus**, wird das Symbol  im Display angezeigt.

Hinweistöne einstellen

Menü Drücken Sie den Softkey **Menü**.



Wählen Sie **MT einstellen** und drücken Sie **Wähle**.

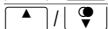

Wählen Sie **Rufton einstell.** und drücken Sie **Wähle**.

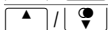

Wählen Sie aus den folgenden Möglichkeiten und bestätigen Sie mit **Wähle**:

Tastenton Schalten Sie den Quittungston für eine Tastenbetätigung ein oder aus.

Akku leer Schalten Sie den Hinweiston ein oder aus. Der Ton signalisiert, wenn der Akku geladen werden muss.

Reichweite Schalten Sie den Hinweiston ein oder aus. Der Ton signalisiert, wenn Sie sich mit dem Mobilteil am Rande der Reichweite zur Basis befinden.

Displaysprache einstellen

Menü Drücken Sie den Softkey **Menü**.



Wählen Sie **MT einstellen** und drücken Sie **Wähle**.

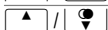

Wählen Sie **Sprache** und drücken Sie **Wähle**.

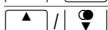

Wählen Sie eine Sprache und bestätigen Sie mit **Wähle**.

Mobilteilnamen einstellen

Menü Drücken Sie den Softkey **Menü**.



Wählen Sie **MT einstellen** und drücken Sie **Wähle**.

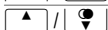







Wählen Sie **MT-Namen ändern** und drücken Sie **Wähle**.









Löschen Sie den alten Namen mit **Lösche**, geben Sie mit den Zifferntasten einen neuen Namen ein und drücken Sie **Ok**.

Kontrast einstellen







Menü Drücken Sie den Softkey **Menü**.

 / 	Wählen Sie MT einstellen und drücken Sie Wähle .
 / 	Wählen Sie Kontrast und drücken Sie Wähle .
 / 	Wählen Sie den gewünschten Kontrast aus und drücken Sie Wähle .

Automatische Rufannahme (Direktannahme) einstellen

Menü	Drücken Sie den Softkey Menü .
 / 	Wählen Sie MT einstellen und drücken Sie Wähle .
 / 	Wählen Sie Direktannahme und drücken Sie Wähle .
 / 	Wählen Sie, ob die automatische Rufannahme ein- oder ausgeschaltet sein soll und bestätigen Sie mit Wähle .





Basisstation auswählen

Menü	Drücken Sie den Softkey Menü .
 / 	Wählen Sie MT einstellen und drücken Sie Wähle .
 / 	Wählen Sie Basisauswahl und drücken Sie Wähle .
 / 	Sie sehen eine Liste der Basisstationen, an denen das Mobilteil angemeldet wurde. Die zurzeit aktive Basis ist mit einem "*" gekennzeichnet. Wählen Sie eine Basis und drücken Sie Wähle .



Es werden nur die Basisstationen angezeigt, an denen das Mobilteil bereits eingebucht worden ist.



Mobilteil in den Auslieferungszustand zurücksetzen





Menü	Drücken Sie den Softkey Menü .
 / 	Wählen Sie MT einstellen und drücken Sie Wähle .
 / 	Wählen Sie MT rücksetzen und drücken Sie Wähle .
	Geben Sie die aktuelle PIN ein und drücken Sie Ok . Bestätigen Sie auch die nachfolgende Sicherheitsabfrage mit Ok .



Die Einträge im Telefonbuch und Nachrichten auf dem Anrufbeantworter werden nicht gelöscht.

Tonruf für die Basisstation einstellen

Menü	Drücken Sie den Softkey Menü .
 / 	Wählen Sie Basis einstellen und drücken Sie Wähle .

 / 	Wählen Sie Tonrufeinstellung und drücken Sie Wähle .
 / 	Wählen Sie aus den folgenden Möglichkeiten und bestätigen Sie mit Wähle :
Tonrufmelodie	Wählen Sie eine Melodie für die Signalisierung eines Anrufes aus.
Tonruflautstärke	Wählen Sie die Lautstärke oder schalten Sie den Tonruf aus.







Wahlverfahren einstellen

Menü	Drücken Sie den Softkey Menü .
 / 	Wählen Sie Basis einstellen und drücken Sie Wähle .
 / 	Wählen Sie Wahlverfahren und drücken Sie Wähle .
 / 	Wählen Sie Tonwahl (DTMF) oder Pulswahl und bestätigen Sie mit Wähle .









Für die meisten Anschlüsse ist **Tonwahl (DTMF)** die richtige Einstellung.

Flashzeit einstellen

Menü	Drücken Sie den Softkey Menü .
 / 	Wählen Sie Basis einstellen und drücken Sie Wähle .
 / 	Wählen Sie Flash-Zeit und drücken Sie Wähle .
 / 	Wählen Sie Kurz (100 ms), Mittel (300 ms) oder Lang (600 ms) aus und bestätigen Sie mit Wähle .





PIN ändern

Menü	Drücken Sie den Softkey Menü .
 / 	Wählen Sie Basis einstellen und drücken Sie Wähle .
 / 	Wählen Sie PIN ändern und drücken Sie Wähle .
	Geben Sie die aktuelle PIN ein (im Auslieferungszustand 0 0 0 0) und drücken Sie Ok .
	Geben Sie eine neue PIN ein und drücken Sie Ok .
	Geben Sie die neue PIN noch einmal ein und drücken Sie Ok .



Die vierstellige PIN schützt einige Einstellungen vor unbefugtem Zugriff. Wenn Sie die PIN vergessen haben, wenden Sie sich bitte an unsere Service-Hotline.

Basisstation in den Auslieferungszustand zurücksetzen

Menü	Drücken Sie den Softkey Menü .
 / 	Wählen Sie Basis einstellen und drücken Sie Wähle .
 / 	Wählen Sie Basis rücksetzen und drücken Sie Wähle .
	Geben Sie die aktuelle PIN ein und drücken Sie Ok . Bestätigen Sie auch die nachfolgende Sicherheitsabfrage mit Ok .



Die Einträge im Telefonbuch werden nicht gelöscht.
Angemeldete Mobilteile bleiben angemeldet.

10 Anrufbeantworter

Der integrierte digitale Anrufbeantworter bietet eine Gesamtaufzeichnungszeit von bis zu 15 Minuten für Ansagetexte und Nachrichten. Maximal können 59 Nachrichten entgegengenommen werden.

Selbst aufgenommene Memos werden wie Nachrichten behandelt.

Der Anrufbeantworter kann sowohl von der Basis als auch vom Mobilteil bedient werden. Mit einem MFV-fähigen Telefon haben Sie außerdem einen PIN-geschützten Fernzugriff auf den Anrufbeantworter.

Es stehen zwei Betriebsarten zur Auswahl:

- Ansage mit Nachrichtenaufzeichnung
- Nur Ansage

Im Auslieferungszustand ist bereits für jede Betriebsart eine Standardansage gespeichert. Damit ist der Anrufbeantworter sofort betriebsbereit. Bei "Ansprache mit Nachrichtenaufzeichnung" und Erreichen der maximalen Aufnahmekapazität schaltet das Gerät automatisch in die Betriebsart "Nur Ansage" um.

Ist der Anrufbeantworter ausgeschaltet, wird nach ca. 10 Rufen der Ansagetext für die Betriebsart "Nur Ansage" abgespielt.

Im Display des Mobilteils erkennen Sie an dem entsprechenden Symbol, dass der Anrufbeantworter eingeschaltet ist.

Beim Abhören der Nachrichten am Mobilteil werden jeweils Datum und Uhrzeit des Eintreffens der Nachricht angezeigt. Voraussetzung dafür ist, dass Datum und Uhrzeit korrekt eingestellt sind (Menü: **Uhrzeit/Alarm / Datum/Zeit**).

Das Display an der Basis gibt Ihnen je nach Betriebszustand folgende Informationen:

- | | |
|----|---|
| -- | Striche konstant an: Anrufbeantworter ist aus.
Blinkt: Anrufbeantworter ist an, Uhrzeit ist nicht eingestellt (bei Erst-Inbetriebnahme). |
|----|---|

XX	Konstant leuchtende Ziffern: Anzahl der alten Nachrichten. Blinkende Ziffern: Anzahl der neuen Nachrichten.
LA	Blinkt: Auf den Anrufbeantworter wird von einem Mobilteil oder per Fernabfrage/-bedienung zugegriffen.
A1/A2	Ansage wird abgespielt. (A1 = Ansage mit Nachrichtenaufzeichnung / A2 = Nur Ansage)
FF	Blinkt: Der Speicher des Anrufbeantworters ist voll.
Lx	Bei Einstellen der Anrufbeantworter-Lautstärke an der Basis: x = Anzeige der aktuellen Lautstärke.

Neue Nachrichten werden im Display des Mobilteils beim Abspielen durch das Symbol ★ gekennzeichnet.









Beim Rücksetzen der Basisstation in den Auslieferungszustand werden eigene Ansagen sowie alle vorhandenen Nachrichten gelöscht.









Bedienungsmöglichkeiten an der Basis

An der Basis können Sie den Anrufbeantworter ein-/ausschalten, Nachrichten abhören und löschen. Die Funktionen der jeweiligen Taste finden Sie im Kapitel "Bedienelemente" vorne in dieser Bedienungsanleitung genannt.

Anrufbeantworter ein-/ausschalten vom Mobilteil

Menü	Drücken Sie den Softkey Menü .
 / 	Wählen Sie Anrufbeantworter und drücken Sie Wähle .
 / 	Wählen Sie AB ein/aus und drücken Sie Wähle .
 / 	Wählen Sie Ein oder Aus und drücken Sie Wähle . Das Symbol im Display erscheint bei eingeschaltetem Anrufbeantworter.

Ansagetext aufsprechen

Menü	Drücken Sie den Softkey Menü .
 / 	Wählen Sie Anrufbeantworter und drücken Sie Wähle .
 / 	Wählen Sie Einstellungen und drücken Sie Wähle .
 / 	Wählen Sie Ansage einst. und drücken Sie Wähle .
 / 	Wählen Sie Ohne Aufzeichnung für die Betriebsart "Nur Ansage" bzw. Mit Aufzeichnung für die Betriebsart

“Ansage mit Aufzeichnung” aus und drücken Sie **Wähle**.

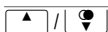

Wählen Sie **Aufnehmen** und drücken Sie **Wähle**. Im Display steht “Ansage aufnehmen”. Sprechen Sie Ihre Ansage in das Mikrofon und drücken Sie **Ok** zum Ende der Aufnahme. Die Ansage wird abgespielt.

Ansagetext anhören

Menü

Drücken Sie den Softkey **Menü**.

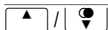

Wählen Sie **Anrufbeantworter** und drücken Sie **Wähle**.

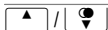

Wählen Sie **Einstellungen** und drücken Sie **Wähle**.

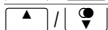

Wählen Sie **Ansage einst.** und drücken Sie **Wähle**.

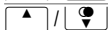

Wählen Sie **Ohne Aufzeichng.** für die Betriebsart “Nur Ansage” bzw. **Mit Aufzeichnung** für die Betriebsart “Ansage mit Aufzeichnung” aus und drücken Sie **Wähle**.



Wählen Sie **Nachricht hören** und drücken Sie **Wähle**. Die Ansage wird abgespielt.

Eigenen Ansagetext löschen

Menü

Drücken Sie den Softkey **Menü**.



Wählen Sie **Anrufbeantworter** und drücken Sie **Wähle**.



Wählen Sie **Einstellungen** und drücken Sie **Wähle**.



Wählen Sie **Ansage einst.** und drücken Sie **Wähle**.



Wählen Sie **Ohne Aufzeichng.** für die Betriebsart “Nur Ansage” bzw. **Mit Aufzeichnung** für die Betriebsart “Ansage mit Aufzeichnung” aus und drücken Sie **Wähle**.



Wählen Sie **Default** und drücken Sie **Wähle**. Die Ansage wird nach einer Sicherheitsabfrage gelöscht.

Nachrichten anhören / einzelne Nachrichten löschen

Menü

Drücken Sie den Softkey **Menü**.



Wählen Sie **Anrufbeantworter** und drücken Sie **Wähle**.



Wählen Sie **Nachricht hören** und drücken Sie **Wähle**.
Der Lautsprecher des Mobilteils wird eingeschaltet und die Nachrichten werden abgespielt.

Während der Wiedergabe haben Sie folgende Möglichkeiten:



Sie können die Lautstärke der Wiedergabe einstellen.

Menü

Drücken Sie **Menü**, wählen Sie mit den Navigationstasten aus und bestätigen Sie mit **Wähle**:

- **Stop**, um die Wiedergabe zu stoppen.
- **Nächste Nachr.**, um die nächste Nachricht wiederzugeben.
- **Vorherige Nachr.**, um zur vorherigen Nachricht bzw. zum Anfang der aktuellen Nachricht zurückzukehren.
- **Löschen**, um die aktuelle Nachricht zu löschen.



Diese Funktionen können Sie auch mit den Zifferntasten durchführen:

- Taste 5: Wiedergabe stoppen.
- Taste 6: zur nächsten Nachricht
- Taste 4: zum Anfang der aktuellen Nachricht bzw. zur vorherigen Nachricht (Taste 4 zweimal drücken)
- Taste 2: aktuelle Nachricht löschen.

Alle alten Nachrichten löschen

Menü

Drücken Sie den Softkey **Menü**.



Wählen Sie **Anrufbeantworter** und drücken Sie **Wähle**.



Wählen Sie **Alle löschen** und drücken Sie **Wähle**.
Alle alten (bereits abgehörten) Nachrichten werden nach einer Sicherheitsabfrage gelöscht.

Memo aufnehmen

Menü

Drücken Sie den Softkey **Menü**.



Wählen Sie **Anrufbeantworter** und drücken Sie **Wähle**.



Wählen Sie **Memo** und drücken Sie **Wähle**.
Sprechen Sie Ihre Mitteilung in das Mikrofon und drücken Sie danach **Ok**. Die Mitteilung wird abgespielt.



Drücken Sie während der Aufnahme oder während des Abspielens **Lösche**, wird das Memo gelöscht.







Gespräch vom Anrufbeantworter übernehmen

Sie können ein bereits vom Anrufbeantworter angenommenes Gespräch mit Ihrem Mobilteil übernehmen, um selbst mit dem Anrufer zu sprechen.



Drücken Sie die Abnehmetaste.

Anrufbeantworter einstellen

Menü	Drücken Sie den Softkey Menü .
 / 	Wählen Sie Anrufbeantworter und drücken Sie Wähle .
 / 	Wählen Sie Einstellungen und drücken Sie Wähle .
 / 	Wählen Sie aus den folgenden Möglichkeiten und bestätigen Sie mit Wähle .
Antwortmodus	Stellen Sie die Betriebsart für den Anrufbeantworter ein.
AB Sprache	Wählen Sie die Sprache für die Standard-Ansage.
Ansage einst.	Ansagetext aufsprechen / anhören / löschen.
Antw. Verzögerung	Wählen Sie die Verzögerung, mit der der Anrufbeantworter einen Anruf annimmt: - 2 Rufe (2 ... 9 Rufe): Annahme nach x Rufen - Sparmodus : Sind neue Nachrichten vorhanden, meldet sich der Anrufbeantworter nach zwei Rufsignalen. Liegen keine neuen Nachrichten vor, wird der Anruf nach sechs Rufsignalen angenommen. Sie können damit bei einer Fernabfrage prüfen, ob neue Nachrichten vorliegen oder nicht ohne eine Verbindung herzustellen.
Auzeichnungszeit	Wählen Sie die verfügbare Zeit für eine Mitteilung aus (60 s, 120 s, 180 s, Unbegrenzt).
Mithören Basis	Schalten Sie das Mithören eintreffender Nachrichten an der Basis Ein oder Aus . Ist das Mithören eingeschaltet, können Sie dem Anrufer zuhören, während er seine Nachricht hinterlässt. Wenn Sie das Gespräch sofort übernehmen wollen, drücken Sie die Abnehme- oder die Freisprechtaste. Wenn Sie nicht durch Anrufe gestört werden wollen, schalten Sie das Mithören aus.
Fernabfrage	Schalten Sie die Fernabfrage Ein oder Aus .
PIN Fernabfr.neu	Geben Sie eine Fernabfrage-PIN ein (im Auslieferungszustand 0 0 0 0). Diese PIN wird benötigt, wenn von einem MFV-fähigen Telefon eine Fernabfrage/Fernbedienung durchgeführt wird.

Fernabfrage/Fernbedienung

Eine Fernabfrage/Fernbedienung kann von einem MFV-fähigen Telefon erfolgen. Wählen Sie die Telefonnummer Ihres Anschlusses.

Ist der Anrufbeantworter ausgeschaltet, meldet sich dieser nach 10 Rufsignalen. Ist er eingeschaltet, meldet er sich mit der voreingestellten Verzögerung. Drücken Sie während der Ansage die Stern-Taste  und geben Sie die Fernabfrage-PIN ein. Nach erfolgreicher PIN-Eingabe stehen Ihnen die folgenden Funktionen zur Verfügung.









Die Verbindung wird nach dreimaliger falscher PIN-Eingabe getrennt.

5	Startet bzw. stoppt die Wiedergabe.
4	Zurück zum Anfang der aktuellen Nachricht. Drücken Sie die Taste zweimal, um zur vorherigen Nachricht zu gelangen.
6	Weiter zur nächsten Nachricht.
2	Löscht die aktuelle Nachricht.
8	Stoppt die Wiedergabe.
7	Schaltet den Anrufbeantworter ein.
9	Schaltet den Anrufbeantworter aus.

11 Mobilteile an-/abmelden







An einer Basisstation können bis zu 5 Mobilteile angemeldet werden. Die mit Ihrem Telefon ausgelieferten Mobilteile sind bereits an der Basis angemeldet. Zum Anmelden eines „fremden“ Mobilteils ziehen Sie bitte auch dessen Bedienungsanleitung zu Rate.

Weiteres Mobilteil des gleichen Typs anmelden

Menü	Drücken Sie den Softkey Menü .
 / 	Wählen Sie MT anmelden und drücken Sie Wähle .
 / 	Wählen Sie eine Basisstation aus und drücken Sie Wähle . Basisstationen, an denen das Mobilteil bereits angemeldet ist, sind in Konturschrift dargestellt. Die aktuelle Basis ist durch einen * gekennzeichnet.
	Geben Sie die aktuelle PIN der Basis ein, an der das Mobilteil angemeldet werden soll und drücken Sie Ok .
	Drücken und halten Sie die Paging-Taste an der Basisstation so lange, bis der Anmelde-ton hörbar ist (ca. 5 Sek.).

Nach einer kurzen Zeit leuchtet das Antennensymbol im Display konstant und das Mobilteil ist angemeldet.

Mobilteil löschen

Menü	Drücken Sie den Softkey Menü .
 / 	Wählen Sie Basis einstellen und drücken Sie Wähle .
 / 	Wählen Sie MT löschen und drücken Sie Wähle .
	Geben Sie die aktuelle PIN ein und drücken Sie Ok .
 / 	Wählen Sie eines der angezeigten Mobilteile aus und drücken Sie Wähle .



Das Mobilteil, das Sie gerade benutzen, kann nicht abgemeldet werden.

12 Betrieb an Telefonanlagen / Zusatzdienste

Betrieb an Telefonanlagen

Ist Ihr Telefon an einer Telefonanlage angeschlossen, können Sie über die R-Taste Funktionen, wie z. B. Anrufe weiterleiten und automatischen Rückruf nutzen. Lesen Sie bitte in der Bedienungsanleitung Ihrer Telefonanlage, welche Flash-Zeit Sie zur Nutzung dieser Funktionen einstellen müssen. Ob Ihr Telefon an Ihrer Telefonanlage einwandfrei funktioniert, erfahren Sie bei dem Händler, bei dem die Anlage gekauft wurde. Bitte denken Sie daran, bei Telefonbucheinträgen ggf. die Amtskennziffer und eine ggf. erforderliche Wahlpause (Ziffer „0“ lange drücken) mit einzugeben.

Zusatzdienste Ihres Netzbetreibers

Ihr Telefon unterstützt Zusatzdienste Ihres Netzbetreibers, wie z. B. Makeln, Anklopfen und Konferenz. Über die R-Taste können Sie diese Zusatzdienste nutzen. Bitte erkundigen Sie sich bei Ihrem Netzbetreiber, welche Flash-Zeit Sie zur Nutzung von Zusatzdiensten einstellen müssen. Zur Freischaltung von Zusatzdiensten wenden Sie sich bitte an Ihren Netzbetreiber.

13 Menüstruktur

Anrufliste	In TB speichern Löschen Alle löschen
Telefonbuch	Lesen Hinzufügen Bearbeiten Löschen Alle löschen Telbuch-Status
Uhrzeit/Alarm	Datum/Zeit Datumsformat Zeitformat Datum eingeben Zeit eingeben
MT einstellen	Alarm Alarm ein / Alarm aus / Alarm Melodie Audioeinstellung FS-Lautstärke Hörerlautstärke Melodie intern Melodie extern Tonruflautstärke Rufton einstell. Tastenton Ein / Aus Akku leer Ein / Aus Reichweite Ein / Aus Sprache Deutsch / English / Française / Italiano MT-Namen ändern Kontrast Level 1-5 Direktannahme Ein / Aus Basisauswahl MT rücksetzen

Basis einstellen	MT löschen	Tonrufmelodie
	Tonrufeinstellung	Tonruflautstärke
	Wahlverfahren	Tonwahl (DTMF) / Pulswahl
	Flash-Zeit	Kurz / Mittel / Lang
	PIN ändern	
	Basis rücksetzen	
MT anmelden		
Anrufbeantworter	Nachricht hören	
	Alle löschen	
	Memo	
	AB ein/aus	
	Einstellungen	Antwortmodus
		AB Sprache
		Ansage einst.
		Antw.Verzögerung
		Auzeichnungszeit
		Mithören Basis
		Fernabfrage
		PIN Fernabfr.neu

14 Fehlersuche

Haben Sie Probleme mit Ihrem Telefon, kontrollieren Sie zuerst die folgenden Hinweise. Bei technischen Problemen können Sie sich an unsere Service-Hotline unter Tel. 0900 00 1675 innerhalb der Schweiz (Kosten aus dem Festnetz von Swisscom bei Drucklegung: CHF 2.60/min) wenden. Bei Garantieansprüchen wenden Sie sich an Ihren Fachhändler. Die Garantiezeit beträgt 2 Jahre.

- Nach Betätigung der Abhebetaste ist kein Wählton hörbar, die Wählleitung wird nicht belegt.
 - Telefonanschluss-Stecker an der Basisstation und an der Telefonsteckdose kontrollieren.
 - Netzstecker an der Basisstation und an 230 V kontrollieren.
 - Die Wählleitung wird durch ein anderes Mobilteil belegt. Warten Sie, bis die Verbindung beendet ist.
- Displayanzeige: **Suche**
 - Netzstecker an der Basisstation und an 230 V kontrollieren.
 - Reichweite verringern.
 - Mobilteil anmelden.
- Keine Anzeige auf dem Display.
 - Mobilteil ausgeschaltet > einschalten.
 - Akkupack leer > aufladen.

Werkseinstellungen/Auslieferungszustand

Anrufliste:	Kein Eintrag
Telefonbuch:	Kein Eintrag
Wecker:	Aus
Tonruf Mobilteil:	Intern: Melodie 2 Extern: Melodie 1 Tonrufflautstärke: 3
Tonruf Basis:	Melodie 1 Tonrufflautstärke: 3
Hinweistöne:	Tastenton: Ein Akku leer: Ein Ausser Reichweite: Ein
Sprache:	Deutsch
Mobilteilname:	DFT 1471
Autom. Rufannahme:	Ein
Datum & Zeit:	Datumsformat: TT-MM-JJJJ Zeitformat: 24 Stunden
Wahlverfahren:	Tonwahl
Flash-Zeit:	Kurz (100 ms)
PIN:	0 0 0 0
Anrufbeantworter:	Ein
AB-Sprache:	Deutsch
Antwortverzögerung:	6 Rufe
Antwortmodus:	Mit Nachrichtenaufzeichnung
Aufnahmezeit:	120 s
Fernabfrage:	Ein
Mithören:	Ein
Fernabfrage-PIN:	0 0 0 0

15 Technische Daten

Standard:	DECT / GAP
Sendeleistung:	10 mW (mittlere Leistung pro Kanal)
Reichweite:	bis zu 300 Meter im Freien, in Gebäuden bis zu 50 Metern
Stromversorgung Basis:	100~240 V _{AC} / 50/60 Hz / 150 mA, 6 V _{DC} / 450 mA
Stromversorgung Ladestation:	100~240 V _{AC} / 50/60 Hz / 150 mA, 6 V _{DC} / 300 mA
Stromversorgung Mobilteil:	NiMH Akkupack / 2,4 V / 500 mAh
Betriebsdauer Mobilteil:	In Bereitschaft / im Gespräch 500 mAh = ca. 100h / ca.10h
Ladezeit der Akkus:	ca. 15 Stunden
Zulässige Umgebungsbedingungen für den Betrieb des Mobilteils:	5 °C bis 40 °C ; 20 % bis 75 % relative Luftfeuchtigkeit
Zulässige Umgebungsbedingungen für den Betrieb der Basisstation:	5 °C bis 40 °C ; 20 % bis 75 % relative Luftfeuchtigkeit
Zulässige Lagertemperatur:	-10 °C bis +60 °C
Wahlverfahren:	MFV / IWV
R-Taste:	Flash (100 ms / 300 ms / 600 ms)

Konformitätserklärung

Dieses Gerät erfüllt die Anforderungen der EU-Richtlinien:

- 1999/5/EG Richtlinie über Funkanlagen und Telekommunikationsendeinrichtungen und die gegenseitige Anerkennung ihrer Konformität.
- 2005/32/EG Richtlinie „Energiebetriebene Produkte“.
- Verordnung 1275/2008 „Stromverbrauch im Bereitschafts- und im Auszustand“.
- Verordnung 278/2009 „Netzteile bei Nulllast sowie ihre durchschnittliche Effizienz im Betrieb“.

Die Konformität mit den o. a. Richtlinien wird durch das CE-Zeichen auf dem Gerät bestätigt.

Für die komplette Konformitätserklärung nutzen Sie bitte den kostenlosen Download von unserer Website www.switel.com.



D

Pflegehinweise

- Reinigen Sie die Gehäuseoberflächen mit einem weichen und fusselfreien Tuch.
- Verwenden Sie keine Reinigungs- oder Lösungsmittel.

16 Garantie

SWITEL - Geräte werden nach den modernsten Produktionsverfahren hergestellt und geprüft. Ausgesuchte Materialien und hoch entwickelte Technologien sorgen für einwandfreie Funktion und lange Lebensdauer. Ein Garantiefall liegt nicht vor, wenn die Ursache einer Fehlfunktion des Geräts bei dem Telefonnetzbetreiber oder einer eventuell zwischengeschalteten Nebenstellenanlage liegt. Die Garantie gilt nicht für die in den Produkten verwendeten Batterien, Akkus oder Akkupacks. Die Garantiezeit beträgt 24 Monate, gerechnet vom Tage des Kaufs.

Innerhalb der Garantiezeit werden alle Mängel, die auf Material- oder Herstellungsfehler zurückzuführen sind, kostenlos beseitigt. Der Garantieanspruch erlischt bei Eingriffen durch den Käufer oder durch Dritte. Schäden, die durch unsachgemäße Behandlung oder Bedienung, natürliche Abnutzung, durch falsches Aufstellen oder Aufbewahren, durch unsachgemäßen Anschluss oder Installation sowie durch höhere Gewalt oder sonstige äußere Einflüsse entstehen, fallen nicht unter die Garantieleistung. Wir behalten uns vor, bei Reklamationen die defekten Teile auszubessern, zu ersetzen oder das Gerät auszutauschen. Ausgetauschte Teile oder ausgetauschte Geräte gehen in unser Eigentum über. Schadenersatzansprüche sind ausgeschlossen, soweit sie nicht auf Vorsatz oder grober Fahrlässigkeit des Herstellers beruhen.

Sollte Ihr Gerät dennoch einen Defekt innerhalb der Garantiezeit aufweisen, wenden Sie sich bitte unter Vorlage Ihrer Kaufquittung ausschließlich an das Geschäft, in dem Sie Ihr SWITEL - Gerät gekauft haben. Alle Gewährleistungsansprüche nach diesen Bestimmungen sind ausschließlich gegenüber Ihrem Fachhändler geltend zu machen. Nach Ablauf von zwei Jahren nach Kauf und Übergabe unserer Produkte können Gewährleistungsrechte nicht mehr geltend gemacht werden.

1	Consignes de sécurité	38
2	Mettre votre téléphone en service . . .	39
3	Éléments de manipulation	42
4	Introduction	43
5	Téléphoner	46
6	Fonctions spéciales	50
7	Liste d'appels / Répétition des derniers numéros . .	51
8	Répertoire	52
9	Réglage du téléphone	53
10	Répondeur	58
11	Déclarer/retirer un combiné	63
12	Installations à postes supplém. / Services confort	64
13	Structure du menu	65
14	Recherche erronée	67
15	Caractéristiques techniques	69
16	Garantie	70

1 Consignes de sécurité

Lisez très attentivement ce mode d'emploi.

Utilisation conforme aux prescriptions

Ce téléphone convient pour téléphoner à l'intérieur d'un réseau téléphonique. Tout autre utilisation est considérée comme non conforme à l'usage. Des modifications ou changements effectués d'un propre gré ne sont pas autorisés. N'ouvrez en aucun cas l'appareil et n'effectuez aucun essai de réparation vous-même.

Lieu d'installation

Évitez toute nuisance par la fumée, la poussière, les vibrations, les produits chimiques, l'humidité, la grande chaleur ou l'ensoleillement direct. Ne vous servez pas du combiné dans des endroits exposés aux explosions.

Bloc secteur



Attention: N'utilisez que le bloc secteur fourni avec l'appareil, d'autres pouvant endommager votre téléphone. Vous ne devez pas bloquer l'accès au bloc secteur par des meubles ou d'autres objets.

Piles rechargeables



Attention: Ne jetez pas les piles rechargeables dans le feu. N'utilisez que le pack de piles rechargeables fourni avec l'appareil. Veillez à une polarisation correcte ! Risque d'explosion lors de leur chargement si la polarisation est incorrecte.

Panne de courant

En cas de panne de courant, vous ne pouvez pas téléphoner avec le téléphone. Tenez à votre disposition, pour parer à de telles situations, un téléphone filaire fonctionnant sans alimentation externe en courant.

Appareils médicaux



Attention: N'utilisez pas ce téléphone à proximité d'appareils médicaux. Leur influence ne peut pas être entièrement exclue.

Les téléphones DECT¹ peuvent causer un bourdonnement désagréable dans les prothèses auditives.

¹DECT: Digital Enhanced Cordless Telecommunication = Standard pour les téléphones sans fil.

Élimination

Si vous voulez mettre votre appareil au rebut, veuillez l'apporter au centre de collecte de l'organisme d'élimination des déchets de votre commune (par ex. centre de recyclage). D'après la loi relative aux appareils électriques et électroniques, les propriétaires d'appareils électriques et électroniques usagés sont tenus de les déposer dans un collecteur séparé. L'icône ci-contre signifie que vous ne devez en aucun cas jeter votre appareil dans les ordures ménagères !



Mise en danger de l'homme et pollution de l'environnement causées par les piles et les piles rechargeables !



Ne jamais ouvrir, endommager, avaler les piles rechargeables et les piles ou ne jamais faire pénétrer leur contenu dans l'environnement. Elles peuvent contenir des métaux lourds toxiques et nuisibles pour celui-ci. Vous êtes tenus par la loi d'éliminer vos piles rechargeables et piles auprès d'un revendeur de piles ainsi qu'auprès de centres de collecte responsables de leur élimination qui mettent des conteneurs adéquats à disposition. L'élimination des piles est gratuite. L'icône ci-contre signifie que vous ne devez en aucun cas jeter les piles rechargeables et piles dans les ordures ménagères, mais que vous devez les éliminer auprès de centres de collecte.

Éliminez les fournitures d'emballage conformément au règlement local.

2 Mettre votre téléphone en service

Remarques concernant la sécurité



Attention: Avant de mettre votre appareil en service, lisez impérativement les consignes de sécurité mentionnées au chapitre 1.

Contrôler le contenu de l'emballage

Les éléments suivants font partie de la livraison :

Contenu	Modèle DFT 147X			
	DFT 1471	DFT 1472	DFT 1473	DFT 1474
Base avec bloc d'alimentation	1	1	1	1
Chargeur avec bloc d'alimentation	-	1	2	3
Combiné	1	2	3	4
Câble de raccord. téléphonique	1	1	1	1
Pack de piles rechargeables	1	2	3	4
Mode d'emploi	1	1	1	1

F

Puissance absorbée

Puissance absorbée de la station de base :

- en mode de fonctionnement (disponible/conversation) : env. 1,5 W
- pendant le chargement du combiné : env. 2,5 W.

Sans charge, le courant d'alimentation à découpage entrant s'élève à env. 0,15 W. Le rendement moyen est d'env. 65 %.

Puissance absorbée de la station de chargement :

- sans le combiné : env. 0,15 W
- pendant le chargement du combiné : env. 1,2 W.

Sans charge, le courant d'alimentation à découpage entrant s'élève à env. 0,15 W. Le rendement moyen est d'env. 60 %.

Raccorder la base



Attention: Posez la base à une distance minimum d'1 m par rapport à d'autres appareils électroniques, une distance inférieure pouvant provoquer des interactions.

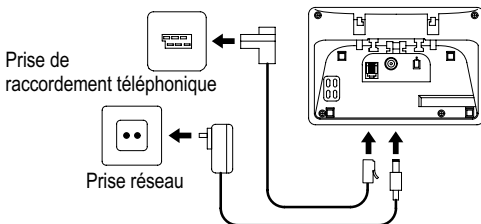

Raccordez la base comme représenté sur le croquis. Pour des raisons de sécurité, n'utilisez que le bloc d'alimentation fourni avec l'appareil ainsi que le câble de raccordement téléphonique ci-joint.



Attention: N'utilisez pour la base que le bloc d'alimentation fourni avec l'appareil !

Mettre en place le pack de piles rechargeables

Poussez le cache batterie vers le bas et retirez-le. Enfoncez la fiche du pack de piles rechargeables dans la prise située dans le compartiment à piles. Insérez le pack dans le compartiment. N'utilisez que le pack de piles rechargeables fourni avec l'appareil. Veillez à ne pas coincer le câble. Reposez le cache sur le compartiment à piles et poussez-le vers le haut jusqu'à ce qu'il s'enclenche.

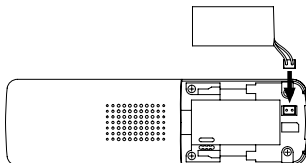

Recharger le pack de piles rechargeables



Lors de la première mise en service, laissez le combiné pendant au moins 15 heures sur la base / la station d'accueil.

Le combiné chauffe lors de la charge. Ceci est normal et sans danger. Ne chargez pas le combiné avec des chargeurs d'autres fabricants. Le niveau de chargement des piles rechargeables est affiché à l'écran. Lorsque le chargement des piles rechargeables a atteint la limite inférieure, le symbole de la pile  clignote sur l'écran.

Réglage de la date et de l'heure

Lors de la mise en service, le combiné n'est pas réglé à l'heure correcte (p. ex. pour les entrées de la liste d'appels/répondeur). Vous réglez la date et l'heure via le menu **Heure/Alarme > Date & Heure ein.**

Paramétrer la langue de l'écran

La langue de l'écran est réglable en 4 langues différentes. Dans son état à la livraison, elle est réglée sur « Allemand ». Vous pouvez changer la langue via le menu "MT einstellen > Sprache" **Réglages Combiné > Langue.**

Prise d'appel automatique / Réponse autom.

Si vous avez activé la fonction, l'appel sera automatiquement réceptionné quand vous prendrez le combiné de la base. La prise d'appel automatique s'active ou se désactive via le menu **Réglages Combiné > Réponse auto.**

3 Éléments de manipulation







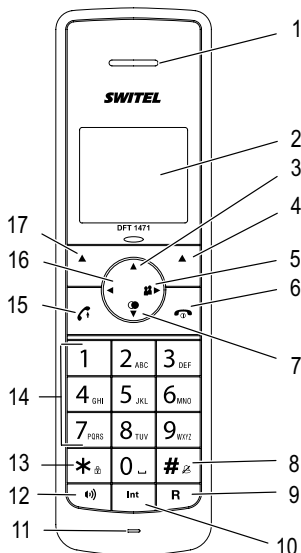

Dans ce mode d'emploi, les touches de votre téléphone sont représentées par des icônes encadrées standardisées. Il peut donc y avoir de légères différences entre les icônes des touches de votre téléphone et celles des touches utilisées ici.

Combiné

- 1 Haut-parleur
- 2 Écran
- 3 Augmenter le volume / Touches de navigation
- 4 Touche softkey
- 5 Liste d'appels / Touches de navigation
- 6 Raccrocher / Éteindre
- 7 Répétition des derniers numéros / Diminuer le volume / Touches de navigation
- 8 Touche # / Désactiver la sonnerie du combiné
- 9 Touche R (Flash)
- 10 Touche interne
- 11 Microphone
- 12 Mains-libres
- 13 Touche * / Verrouillage du clavier
- 14 Pavé numérique
- 15 Répondre
- 16 Touches de navigation
- 17 Touche softkey



Base



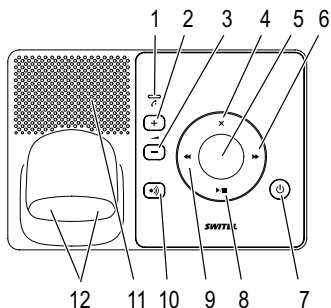





- 1 LED : affichage de communications
- 2 Volume sonore + 
- 3 Volume sonore - 
- 4 Effacer 
- 5 Écran
- 6 Message suivant 
- 7 Répondeur marche / arrêt 
- 8 Reproduction de messages 
- 9 Répéter le message / Message précédent 
- 10 Chercher le combiné (Paging) 
- 11 Haut-parleur
- 12 Contacts de chargement













4 Introduction

Dans ce chapitre, vous trouverez des informations de base vous expliquant comment vous servir du mode d'emploi et du téléphone.

Mode de représentation dans le mode d'emploi

	Appuyer sur la touche représentée
2 sec. 	Appuyer 2 secondes sur la touche représentée
	Saisir des chiffres ou des lettres
	Le combiné sonne
	La base sonne
	Prendre le combiné de la base
	Poser le combiné sur la base
Alarme	Visualisation des textes de l'écran
	Visualisation des icônes de l'écran





Icônes à l'écran du combiné

Icône	Description
	Constant : la liaison avec la base est bonne. Clignotant : la liaison avec la base s'interrompt.
	Constant : affichage de la capacité des piles. Segments continus quand le combiné est sur la base : Les piles rechargeables se rechargent.
JJ-MM	Affichage de la date ☞ page 53.
HH:MM	Affichage de l'heure ☞ page 53.
	Le mode mains-libres est activé.
	Constant : la fonction d'alarme est activée. Clignotant : alarme ☞ page 53.
	Constant : Vous téléphonez. Clignotant : Le téléphone sonne.
	Vous tenez une communication interne (uniquement si base avec plusieurs combinés) ☞ page 48; Réception d'un message interne.
	Quand affichage de la liste d'appels: nouvel appel Quand écoute des messages du répondeur : nouveau message
	Le verrouillage du clavier est activé ☞ page 50.
Muet	Le microphone est programmé sur secret ☞ page 48.
	La sonnerie d'appel est désactivée ☞ page 50.
	Le répondeur est branché ☞ page 59.



Dans les lignes de l'écran ci-dessous sont indiquées les fonctions disponibles liées aux deux **touches softkeys** dépendamment de l'état de fonctionnement.

Menu	Ouvrir le menu principal.
Répert	Ouvrir le répertoire.
Sélect	Ouvrir le menu affiché.
Ok	Confirmation d'un réglage.
Retour	Retour au menu supérieur ou interruption de la programmation.
Efface	Effacer à reculons les signes de l'entrée (une pression courte efface le dernier signe, une pression longue efface la ligne entière).

Fonctions des touches de navigation

	Dans le menu / dans les listes (répertoire, liste d'appels, répétition des derniers numéros) : feuilleter plus haut. Pendant une communication : augmenter le volume.
	Pendant l'utilisation d'entrées / lors de la préparation de l'appel : déplacer le curseur vers la gauche.
	En mode veille : ouvrir la liste d'appels. Pendant l'utilisation d'entrées / lors de la préparation de l'appel : déplacer le curseur vers la droite.
	En mode veille : ouvrir la liste de répétition des derniers numéros. Pendant une communication : diminuer le volume. Dans le menu / dans les listes (répertoire, liste d'appels, répétition des derniers numéros) : feuilleter plus bas.

Fonctions particulières de certaines touches

	Pendant l'entrée du numéro : une pression longue introduit une pause.
	En mode veille : une pression longue de la touche active/désactive le verrouillage des touches. Pendant l'entrée d'un nom : une pression longue de la touche change le caractère (latin/russe/grec), Tableaux voir Annexe. Pendant une liaison : changement temporaire sur la numérotation par tonalité quand la numérotation par impulsion est activée.

#

En mode veille : une pression longue de la touche active/désactive la sonnerie du combiné.
 Pendant l'entrée d'un nom : une pression longue change entre majuscules et minuscules.

Mode veille



Toutes les descriptions dans ce mode d'emploi partent du principe que le combiné se trouve en mode veille. Vous parviendrez au mode veille en appuyant sur la touche .

Réduction du rayonnement (mode ÉCO)

En comparaison avec les téléphones sans fil DECT standard, le rayonnement est considérablement réduit, aussi bien en mode de communication qu'en mode veille, quand le mode ECO est activé.





Navigation dans le menu



Vous pouvez accéder à toutes les fonctions via différents menus. Vous trouvez la structure complète du menu dans l'annexe. Pour naviguer dans le menu, utilisez les touches softkeys et fléchées. Avec touche softkey **Menu** vous ouvrez le menu. Avec les touches fléchées  ou  vous naviguez dans le menu. Pour ouvrir un sous-menu, appuyez sur la touche softkey **Sélect**. Si vous voulez revenir au menu supérieur, appuyez brièvement sur **Retour**. Par pression de la touche raccrocher  vous vous retrouvez de nouveau en mode veille.

5 Téléphoner



Prendre l'appel

  Votre téléphone sonne.

Si le combiné **ne** se trouve pas sur la base:

 /  Appuyez sur la touche décrocher ou la touche mains-libres.

Si le combiné se trouve sur la base et **Réponse Auto n'est pas activé**:

 /  Prenez le combiné de la base et appuyez sur la touche décrocher ou la touche mains-libres.

Si le combiné se trouve sur la base et **Réponse Auto** est activé:

 Prenez simplement le combiné de la base ; la communication est réceptionnée automatiquement.

Appeler



Entrez le numéro de téléphone.
Corrigez une erreur d'entrée avec **Efface**.

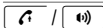

Le numéro de téléphone est composé.



Vous pouvez aussi appuyer d'abord sur la touche communication et vous obtenez ainsi la tonalité. Les chiffres entrés du numéro de téléphone choisi sont aussitôt composés. Il n'est pas possible de corriger les chiffres du numéro de de téléphone dans cette forme de mise en communication.

Terminer la communication



Appuyer sur la touche décrocher ou poser le combiné sur la base.

Répétition des derniers numéros



Votre téléphone mémorise les 10 derniers numéros de téléphone composés. Si le numéro de téléphone est mémorisé dans le répertoire, le nom s'affiche. Pour afficher le numéro de téléphone correspondant, appuyez sur la touche



Ouvrir la liste de répétition des derniers numéros.



Sélectionner l'enregistrement.

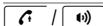

Le numéro est composé.

Appeler depuis la liste d'appels



Votre téléphone mémorise les 20 derniers appels dans la liste d'appels. Si le numéro de téléphone est mémorisé dans le répertoire, le nom s'affiche. Pour afficher le numéro de téléphone correspondant, appuyez sur la touche **Sélect**.

L'enregistrement ne peut avoir lieu que si la fonction « transfert d'appel (CLIP) » est disponible sur votre raccordement et le numéro de l'appelant n'a pas été retenu ou rendu non transmissible pour d'autres raisons.



Ouvrir la liste d'appels.



Sélectionner l'enregistrement.

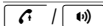

Le numéro est composé.

Appeler depuis le répertoire



Le répertoire peut recevoir 50 entrées.
Pour mémoriser des entrées voir le paragraphe « Répertoire ».

Répert

Ouvrir le répertoire.



Sélectionner l'enregistrement.

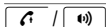

Le numéro est composé.

Affichage de la durée de la communication

Pendant une communication, sa durée est affichée en heures, minutes et secondes.

Régler le volume sonore de l'écouteur



Vous disposez de 5 niveaux pour régler le volume pendant une communication (sous fonctionnement de l'écouteur-> Volume sonore de l'écouteur, en mains-libres -> volume sonore du haut-parleur). Les réglages sont indépendants les uns des autres et restent mémorisés même après fin de la communication.

Débranchement du microphone du combiné

Muet

Vous pouvez désactiver le microphone pendant une communication afin que votre interlocuteur ne puisse pas vous déranger. **Muet** s'affiche sur l'écran.

Parler



pour activer le microphone, appuyez de nouveau sur la touche.

Téléphoner en interne







Communication internes, transferts et communications en conférence sont possibles uniquement si plusieurs combinés sont déclarés. Si ce n'est pas le cas, **Indisponible** s'affichera sur l'écran.







Int

Appuyez la touche **Int**. Si deux combinés sont déclarés, l'autre combiné est aussitôt appelé. Dans le cas de plusieurs combinés déclarés, leurs numéros internes s'affichent (p. ex. 2 3 4). Sélectionnez le combiné souhaité avec la touche fléchée  /  et appuyez sur **Sélect**. Si vous sélectionnez « 9 » dans le cas de plusieurs combinés déclarés, tous sont appelés simultanément.







Transfert d'une communication externe

	Pendant une communication externe. . .
	Appuyez la touche  . Sélectionnez le combiné souhaité avec la touche fléchée  /  et appuyer sur Sélect. La communication externe est maintenue. Si le combiné appelé est activé, annoncer la communication le cas échéant.
	Appuyez sur la touche raccrocher. La communication est transmise.

Va-et-vient

	Pendant une communication externe. . .
	Appuyez la touche  . Sélectionnez le combiné souhaité avec la touche fléchée  /  et appuyer sur Sélect. La communication externe est maintenue.
	Avec la touche  vous passez d'un interlocuteur à l'autre.

Conférence

	Pendant une communication externe. . .
	Appuyez la touche  . Sélectionnez le combiné souhaité avec la touche fléchée  /  et appuyer sur Sélect. La communication externe est maintenue.
	Appuyez et maintenez la touche  jusqu'à l'apparition de Conférence sur l'écran.



l'un des participants à la conférence raccroche, les deux autres restent en communication.

6 Fonctions spéciales

Verrouillage du clavier



La touche verrouillage empêche une manipulation involontaire des touches. Les appels peuvent être reçus comme d'habitude.

*_☎

Appuyez et maintenez la touche étoile jusqu'à l'apparition du symbole de verrouillage des touches.

*_☎

Pour déverrouiller le clavier, appuyez et maintenez de nouveau la touche étoile jusqu'à la disparition du symbole.

Désactiver la sonnerie du combiné



Vous pouvez désactiver la sonnerie d'appel aussi via le menu **Réglages Combiné > Réglages sonn. > Volume Sonnerie.**

#_☎

Appuyez et maintenez la touche dièse jusqu'à l'apparition du symbole de désactivation de la sonnerie d'appel .

#_☎

Pour réactiver la sonnerie d'appel, appuyez et maintenez de nouveau la touche dièse jusqu'à disparition du symbole.

Désactiver le combiné



Vous pouvez désactiver le combiné pour économiser les piles rechargeables.







Appuyez sur raccrocher et maintenez la touche appuyée. Après quelques secondes, le combiné est désactivé. L'éclairage de l'écran s'éteint.







Pour réactiver le combiné, appuyez sur la touche raccrocher jusqu'à ce que vous entendiez le signal sonore et que l'écran s'éclaire de nouveau.

7 Liste d'appels / Répétition des derniers numéros

Utiliser la liste d'appels

	Ouvrez la liste d'appels.
 / 	Sélectionnez une entrée et appuyez sur Sélect. Date et heure de l'appel sont affichées.
Menu	Appuyez sur touche softkey Menu .
 / 	Sélectionnez l'une des options suivantes et confirmez avec Sélect :
Ajouter au rép.	Le numéro est enregistré dans le répertoire. Entrez le nom, confirmez ou modifiez le numéro et fixez une mélodie sonore pour cette entrée.
Effacer	L'entrée est effacée après une question de sécurité.
Tout effacer	La liste complète est effacée après une question de sécurité.

Utiliser la répétition des derniers numéros









	Ouvrir la répétition des derniers numéros.
 / 	Sélectionnez une entrée et appuyez sur Sélect.
Menu	Appuyez sur touche softkey Menu .
 / 	Sélectionnez l'une des options suivantes et confirmez avec Sélect :
Ajouter au rép.	Le numéro est enregistré dans le répertoire. Entrez le nom, confirmez ou modifiez le numéro et fixez une mélodie sonore pour cette entrée.
Effacer	L'entrée est effacée après une question de sécurité.
Tout effacer	La liste complète est effacée après une question de sécurité.

8 Répertoire





Dans le répertoire, vous pouvez mémoriser 50 numéros et noms correspondants. Vous pouvez associer à chaque entrée une mélodie propre par laquelle un appel doit être signalé. Entrez toujours les numéros avec le préfixe ; ceci permet un affichage correct de chaque appelant dont il existe une entrée et dont le transfert de numéro à votre raccordement est disponible.

Saisir une nouvelle entrée

Menu	Appuyez sur touche softkey Menu .
 / 	Sélectionner Répertoire et confirmer sur Sélect .
 / 	Le cas échéant, sélectionner Ajouter et appuyer sur Sélect .
	Entrez le nom (12 signes maximum). Les touches de chiffres comportent des lettres. Lettres et chiffres peuvent être entrés par pressions répétées de la touche correspondante. Une pression longue de la touche # change entre majuscules et minuscules. Après peu de temps, le curseur se déplace vers la droite. Terminez l'entrée du nom avec Ok .
	Entrez le numéro (24 chiffres maximum). Si votre téléphone est raccordé à une installation téléphonique, entrez aussi le code d'identification. Si une pause est nécessaire, après le code d'identification, appuyez sur la touche 0 pendant env. 2 s ; P s'affiche sur l'écran. Terminez l'entrée du numéro avec Ok .
 / 	Sélectionnez une mélodie pour l'entrée.
Sélect	Confirmez avec Sélect .







Utiliser les entrées du répertoire

Menu	Appuyez sur touche softkey Menu .
 / 	Sélectionner Répertoire et confirmer sur Sélect .
 / 	Sélectionnez l'une des options suivantes et confirmez avec Sélect :
Lire	Toutes les entrées sont affichées. Feuilletez jusqu'à l'entrée souhaitée. Avec Sélect , vous voyez le nom, le numéro de téléphone et la mélodie. Avec Menu , vous pouvez modifier ou effacer l'entrée.

Ajouter	Vous pouvez effectuer une nouvelle entrée.
Editer	Toutes les entrées sont affichées. Feuilletez jusqu'à l'entrée souhaitée. Après Sélect , vous pouvez modifier l'entrée. Effacez les lettres et chiffres avec Annule , entrez de nouvelles lettres et chiffres avec les touches de chiffres. Pour plus de détails, voir « insérer nouvelle entrée ».
Effacer	Toutes les entrées sont affichées. Feuilletez jusqu'à l'entrée souhaitée. Après Sélect l'entrée est effacée.
Tout effacer	Après Sélect , le répertoire entier est effacé après une question de sécurité.
Etat répertoire	La configuration actuelle est affichée (p. ex. 7 / 50 Occ. : 7 sur 50 entrées possibles sont existantes).

9 Réglage du téléphone





Date/heure









Menu	Appuyez sur touche softkey Menu .
 / 	Sélectionnez Heure/Alarme et appuyer sur Sélect .
 / 	Sélectionnez Date & Heure et appuyer sur Sélect .
 / 	Sélectionnez l'une des options suivantes et confirmez avec Sélect .
Format date	Vous pouvez régler la représentation de la date : (JJ-MM-AAAA ou MM-JJ-AAAA).
Format Heure	Vous pouvez régler la représentation de l'heure: (24 heures ou 12 heures).
Réglage Date	Entrez l'heure avec les touches de chiffres.
Réglages Heure	Entrez la date avec les touches de chiffres. Pour une entrée en format de 12h, changez avec la touche étoile entre « AM » et « PM ».









En cas de panne de courant, le réglage est perdu si le combiné est désactivé en même temps ou les piles rechargeables sont vides.

Réveil

Menu	Appuyez sur touche softkey Menu .
 / 	Sélectionnez Heure/Alarme et appuyer sur Sélect .
 / 	Sélectionnez Alarme et appuyer sur Sélect .

 / 	Sélectionnez Alarme On et appuyez sur Sélect.
	Entrez l'heure de réveil avec les touches de chiffres et appuyez sur Ok .
 / 	Sélectionnez Snooze on ou Snooze off et appuyez sur Sélect. Si Snooze est activé, cela signifie que le signal de réveil sera répété après 2 minutes, jusqu'à ce que cette fonction soit arrêtée par pression et maintien de la touche raccrocher. Si Snooze est désactivé, le signal de réveil retentira une seule fois à l'heure fixée. Pour quitter le signal de réveil, appuyez sur une touche quelconque.
 / 	Sélectionnez Sonnerie alarme et appuyez sur Sélect.
 / 	Sélectionnez une mélodie et appuyez sur Sélect.







Réglages audio du combiné

Menu	Appuyez sur touche softkey Menu .
 / 	Sélectionnez Réglages Combiné et appuyez sur Sélect.
 / 	Sélectionnez Réglages audio et appuyez sur Sélect.
 / 	Sélectionnez l'une des options suivantes et confirmez avec Sélect :
Vol. H-parleur	Sélectionnez le volume pour la lecture en fonctionnement mains-libres.
Volume d'écoute	Sélectionnez le volume de l'écouteur.



Vous pouvez aussi effectuer simplement ces réglages pendant une communication avec les touches fléchées (s. « Téléphoner / Régler le volume sonore de l'écouteur »)

Régler la sonnerie du combiné

Menu	Appuyez sur touche softkey Menu .
 / 	Sélectionnez Réglages Combiné et appuyez sur Sélect.
 / 	Sélectionnez Réglages sonn. et appuyez sur Sélect.
 / 	Sélectionnez l'une des options suivantes et confirmez avec Sélect :
Sonnerie Interne	Sélectionnez une mélodie pour la signalisation d'un appel interne.

Sonnerie Externe Sélectionnez une mélodie pour la signalisation d'un appel externe



Volume Sonnerie Sélectionnez le volume de la sonnerie. Sélectionnez **Volume Off**, le symbole  s'affiche sur l'écran.

Régler la tonalités d'information

Menu Appuyez sur touche softkey **Menu**.

 /  Sélectionnez **Réglages Combiné** et appuyez sur **Sélect**.

 /  Sélectionnez **Alertes Sonores** et appuyez sur **Sélect**.

 /  Sélectionnez l'une des options suivantes et confirmez avec **Sélect**:

Bip touches Activez ou désactivez la tonalité de confirmation pour l'activation d'une touche.



Batterie faible Activez ou désactivez la tonalité d'information spéciale. La tonalité signale quand les piles rechargeables doivent être chargées.



Hors Portée Activez ou désactivez la tonalité d'information spéciale. La tonalité signale quand vous vous trouvez avec le combiné à la limite de portée de la base.

Régler la langue de l'écran

Menu Appuyez sur touche softkey **Menu**.

 /  Sélectionnez **Réglages Combiné** et appuyez sur **Sélect**.

 /  Sélectionnez **Langue** et appuyez sur **Sélect**.

 /  Sélectionnez une langue et confirmez avec **Sélect**.

Régler le nom du combiné







Menu Appuyez sur touche softkey **Menu**.

 /  Sélectionnez **Réglages Combiné** et appuyez sur **Sélect**.







 /  Sélectionnez **Renommer combiné** et appuyez sur **Sélect**.

 Effacez l'ancien nom avec **Efface**, entrez le nouveau nom avec les touches de chiffres et appuyez sur **Ok**.







Régler le contraste

Menu	Appuyez sur touche softkey Menu .
 / 	Sélectionnez Réglages Combiné et appuyer sur Sélect .
 / 	Sélectionnez Contraste et appuyer sur Sélect .
 / 	Sélectionnez le contraste souhaité et appuyez sur Sélect .

Régler la réponse d'appel automatique

Menu	Appuyez sur touche softkey Menu .
 / 	Sélectionnez Réglages Combiné et appuyer sur Sélect .
 / 	Sélectionnez Réponse auto et appuyez sur Sélect .
 / 	Choisissez si la réponse automatique doit être activée ou désactivée et confirmez avec Sélect .





Sélectionner la base

Menu	Appuyez sur touche softkey Menu .
 / 	Sélectionnez Réglages Combiné et appuyer sur Sélect .
 / 	Sélectionnez Choix base et appuyer sur Sélect .
 / 	Vous voyez une liste des bases auxquelles le combiné a été déclaré. La base activée actuellement est caractérisée par une « * ». Sélectionnez une base et appuyez sur Sélect .



Seules sont indiquées les bases auxquelles le combiné a déjà été enregistré.







Remettre le combiné dans l'état à la livraison

Menu	Appuyez sur touche softkey Menu .
 / 	Sélectionnez Réglages Combiné et appuyer sur Sélect .
 / 	Sélectionnez Rég. CB Défaut et appuyer sur Sélect .
	Entrez le PIN actuel et appuyez sur Ok . Confirmez aussi la question de sécurité suivante avec Ok .









Les entrées du répertoire et les messages éventuels sur le répondeur ne sont pas effacés.

Régler la sonnerie de la base







Menu	Appuyez sur touche softkey Menu .
 / 	Sélectionnez Réglages Base et appuyez sur Sélect.
 / 	Sélectionnez Réglages sonn. et appuyez sur Sélect.
 / 	Sélectionnez l'une des options suivantes et confirmez avec Sélect.
Sonnerie	Sélectionnez une mélodie pour la signalisation d'un appel.
Volume Sonnerie	Sélectionnez le volume ou désactivez la sonnerie.

Régler le processus de numérotation







Menu	Appuyez sur touche softkey Menu .
 / 	Sélectionnez Réglages Base et appuyez sur Sélect.
 / 	Sélectionnez Numérotation et appuyez sur Sélect.
 / 	Sélectionnez FV ou DC et confirmez avec Sélect.

 Pour la plupart des raccordements, le réglage correct est **FV**.

Réglez le temps de flash

Menu	Appuyez sur touche softkey Menu .
 / 	Sélectionnez Réglages Base et appuyez sur Sélect.
 / 	Sélectionnez Touche R et appuyez sur Sélect.
 / 	Sélectionnez Court (100 ms), Medium (300 ms) oder Long (600 ms) et confirmez avec Sélect.







Modifier le PIN

Menu	Appuyez sur touche softkey Menu .
 / 	Sélectionnez Réglages Base et appuyez sur Sélect.
 / 	Sélectionnez Modifier PIN et appuyez sur Sélect.
	Entrez le PIN actuel (Etat à la livraison : 0 0 0 0) et appuyez sur Ok .
	Entrez un nouveau PIN et appuyez sur Ok .
	Entrez le nouveau PIN une nouvelle fois et appuyez sur Ok .



Le PIN à quatre chiffres protège quelques réglages contre un accès non autorisé. Si vous avez oublié le PIN, merci de vous adresser à notre service hotline.

Remettre la base comme à l'état de livraison

	Appuyez sur touche softkey Menu .
 / 	Sélectionnez Réglages Base et appuyer sur Sélect.
 / 	Sélectionnez Rég. défaut base et appuyez sur Sélect.
	Entrez le PIN actuel et appuyez sur Ok . Confirmez aussi la question de sécurité suivante avec Ok .



Les entrées du répertoire ne sont pas effacées.
Les combinés déclarés restent déclarés.

10 Répondeur

Le répondeur numérique intégré offre un temps d'enregistrement total jusqu'à 15 minutes pour textes d'annonce et messages. Un maximum de 59 messages peut être réceptionné.

Les mémos réceptionnés sont traités comme des messages.

Le répondeur peut être commandé aussi bien depuis la base que depuis le combiné. Avec un téléphone permettant le procédé MFV, vous avez en outre accès au répondeur à distance, protégé par un PIN.

Deux modes de fonctionnement sont disponibles :

- Annonce avec enregistrement de message
- Annonce uniquement

A l'état de livraison, une annonce standard est déjà enregistrée pour chaque mode de fonctionnement. Le répondeur est ainsi prêt à fonctionner immédiatement. Avec « annonce avec enregistrement de message » et atteinte de la capacité maximum d'enregistrement, l'appareil change automatiquement vers le mode de fonctionnement « annonce uniquement ».

Si le répondeur est désactivé, le texte d'annonce de mode de fonctionnement « annonce uniquement » est lu après environ 10 appels.

Vous reconnaissez au symbole correspondant sur l'écran du combiné que le répondeur est activé.

Lors de l'écoute des messages au combiné, la date et l'heure d'arrivée du message sont affichées à condition que la date et l'heure soient réglées correctement (Menu : **Heure/Alarme / Date & Heure**).

L'écran de la base vous fournit les informations suivantes en fonction de l'état de fonctionnement:

- Tirets en permanence : répondeur désactivé.
Clignotant: répondeur activé, Heure non réglée.
(Lors de la première mise en service).

XX	Chiffres éclairés constamment : nombre des anciens messages. Chiffres clignotant : nombre des nouveaux messages.
LA	Clignotant : il y a accès au répondeur depuis un combiné ou par commande à distance.
A1/A2	Lecture de l'annonce (A1=Annonce avec enregistrement de message / A2 = annonce uniquement)
FF	Clignotant: la mémoire du répondeur est pleine.
Lx	Lors du réglage du volume du répondeur sur la base : x=Affichage du volume actuel.

Lors de la lecture, les nouveaux messages sont caractérisés sur l'écran du combiné par le symbole ★ .









Lors de la remise du téléphone à l'état de livraison, les propres annonces ainsi que tous les messages existants sont effacés.







Manipulations sur la base

Vous pouvez activer/désactiver le répondeur sur la base, écouter et effacer des messages. Vous trouverez les fonctions des touches respectives dans le chapitre intitulé « Éléments de manipulation » au début de ce mode d'emploi.

Activer/désactiver le répondeur (Combiné)

Menu	Appuyez sur touche softkey Menu .
 / 	Sélectionnez Répondeur et appuyez sur Sélect.
 / 	Sélectionnez Rép. On/Off et appuyez sur Sélect.
 / 	Sélectionnez On ou Off et appuyez sur Sélect. Le symbole sur l'écran apparaît lorsque le répondeur est activé.

Enregistrer le texte d'annonce

Menu	Appuyez sur touche softkey Menu .
 / 	Sélectionnez Répondeur et appuyez sur Sélect.
 / 	Sélectionnez Rég. Répondeur et appuyez sur Sélect.
 / 	Sélectionnez Régl. annonces et appuyez sur Sélect.



Sélectionnez **Rép. Seul** pour le mode de fonctionnement « annonce uniquement » ou **Rép Enregistreur** pour le mode de fonctionnement « annonce avec enregistrement de message » et appuyez sur **Sélect.**

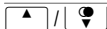

Sélectionnez **Enregistrer** et appuyez sur **Sélect.** Vous lisez "Enregistrement".
Dites votre annonce dans le microphone et appuyez sur **Ok** à la fin de l'enregistrement. L'annonce est lue.

Ecouter le texte de l'annonce

Menu

Appuyez sur touche softkey **Menu**.

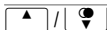

Sélectionnez **Répondeur** et appuyez sur **Sélect.**

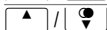

Sélectionnez **Rég. Répondeur** et appuyez sur **Sélect.**

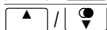

Sélectionnez **Régl. annonces** et appuyez sur **Sélect.**

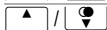

Sélectionnez **Rép. Seul** pour le mode de fonctionnement « annonce uniquement » ou **Rép Enregistreur** pour le mode de fonctionnement « annonce avec enregistrement de message » et appuyez sur **Sélect.**

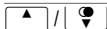

Sélectionnez **Lire** et appuyez sur **Sélect.**
L'annonce est lue.

Effacer texte d'annonce personnel

Menu

Appuyez sur touche softkey **Menu**.



Sélectionnez **Répondeur** et appuyez sur **Sélect.**

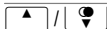

Sélectionnez **Rég. Répondeur** et appuyez sur **Sélect.**



Sélectionnez **Régl. annonces** et appuyez sur **Sélect.**



Sélectionnez **Rép. Seul** pour le mode de fonctionnement « annonce uniquement » ou **Rép Enregistreur** pour le mode de fonctionnement « annonce avec enregistrement de message » et appuyez sur **Sélect.**

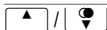

Sélectionnez **Défaut** et appuyez sur **Sélect.**
Votre annonce personnelle est effacée.

F

Ecouter les messages/effacer certains messages

Menu

Appuyez sur touche softkey **Menu**.

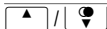

Sélectionnez **Répondeur** et appuyez sur **Sélect.**



Sélectionnez **Lire** et appuyez sur **Sélect.**
Le haut-parleur du combiné est activé et les messages sont lus.

Pendant la lecture, vous avez les options suivantes:



Vous pouvez régler le volume de la lecture.

Menu

Appuyez sur **Menu**, sélectionnez avec les touches fléchées et confirmez avec **Sélect.**

- **Stop**, pour arrêter la lecture.
- **Suivant**, pour lire le message suivant.
- **Précédent**, pour retourner au message précédent ou au début du message actuel.
- **Effacer**, pour effacer le message actuel.



Vous pouvez exécuter ces fonctions avec les touches de chiffres:

- Touche 5: arrêter la lecture
- Touche 6: vers le message suivant
- Touche 4: vers le message précédent ou au début du message actuel (appuyez deux fois sur la touche 4).
- Touche 2: effacer le message actuel.

Effacer tous les anciens messages

Menu

Appuyez sur touche softkey **Menu**.



Sélectionnez **Répondeur** et appuyer sur **Sélect.**



Sélectionnez **Tout effacer** et appuyez sur **Sélect.**

Tous les anciens messages (déjà écoutés) sont effacés après une question de sécurité.

Enregistrer un mémo

Menu

Appuyez sur touche softkey **Menu**.



Sélectionnez **Répondeur** et appuyer sur **Sélect.**



Sélectionnez **Mémo** et appuyez sur **Sélect.**

Dites votre communiqué dans le microphone et appuyez ensuite sur **Ok**. Le communiqué est lu.



Quand vous appuyez **Annule**, pendant la réception ou la lecture, le mémo est effacé.

F







Prendre une communication depuis le répondeur

Vous pouvez prendre avec votre combiné une communication déjà réceptionnée par le répondeur, afin de parler personnellement avec l'appelant.



Appuyez la touche répondre.

Régler le répondeur

Menu	Appuyez sur touche softkey Menu .
 / 	Sélectionnez Répondeur et appuyez sur Sélect.
 / 	Sélectionnez Rég. Répondeur et appuyez sur Sélect.
 / 	Sélectionnez l'une des options suivantes et confirmez avec Sélect.
Mode Répondeur	Réglez le mode de commande du répondeur.
Langue Rép.	Sélectionnez la langue pour l'annonce standard.
Régl. annonces	Dire le texte de l'annonce/écouter le texte de l'annonce.
Nb de Sonneries	Sélectionnez avec les touches fléchées l'attente après laquelle le répondeur répond à un appel: - 2 Sonneries (2...9 Sonneries): Réponse après x appels - Eco mode : S'il y a de nouveaux messages, le répondeur se déclenche après deux signaux d'appel. S'il n'y a aucun nouveau message, l'appel est reçu après six signaux d'appel. Vous pouvez ainsi contrôler par interrogation à distance s'il y a de nouveaux appels ou pas sans liaison.
Temps Enregist.	Sélectionnez avec les touches fléchées le temps disponible pour un communiqué (60 s, 120 s, 180 s, illimité).
Filtrage Base	Réglez l'écoute des messages arrivant sur la base sur On ou Off . Si l'écoute est activée, vous pouvez écouter l'appelant pendant qu'il laisse son message. Si vous voulez prendre la communication aussitôt, appuyez sur la touche décrocher ou mains-libres. Si vous ne voulez pas être dérangé par des appels, désactivez l'écoute.
Code d'interro	Réglez l'interrogation sur On ou Off .
Modifier PIN	Entrez un PIN d'interrogation (état à la livraison 0 0 0 0). Ce PIN est requis si une interrogation ou une commande à distance a lieu depuis un téléphone permettant le procédé MFV.

Interrogation/Commande à distance

Une interrogation/commande à distance peut avoir lieu depuis un téléphone permettant le procédé MFV. Sélectionnez le numéro de téléphone de votre raccordement.

Si le répondeur est désactivé, il se branche après 10 signaux d'appel. S'il est activé, il se branche après le temps d'attente réglé au préalable. Pendant l'annonce, appuyez sur la touche étoile  et entrez le PIN d'interrogation. Après une entrée du PIN réussie, les fonctions suivantes sont à votre disposition.









Cette mise en relation est interrompue après trois entrées de PIN erronées.

5	Commence ou arrête la lecture.
4	Retour au début du message actuel. Appuyez sur la touche deux fois, afin de retourner au message précédent.
6	Vers le message suivant.
2	Efface le message actuel.
8	Arrête la lecture.
7	Active le répondeur.
9	Désactive le répondeur.

11 Déclarer/retirer un combiné







Sur une base, vous pouvez déclarer jusqu'à 5 combinés. Les combinés livrés avec votre téléphone sont déjà déclarés sur la base. Pour déclarer un combiné « étranger », consultez aussi la notice d'utilisation de ce combiné.

Déclarer un autre combiné du même type

Menu	Appuyez sur touche softkey Menu .
 / 	Sélectionnez Association et appuyez sur Sélect .
 / 	Sélectionnez une base et appuyez Sélect . Les bases auprès desquelles le mobile est déjà inscrit sont représentées en caractères à jour. La base actuelle est caractérisée par un *.
	Entrez le PIN actuel de la base sur laquelle le combiné doit être déclaré et appuyez sur Ok .
	Appuyez et maintenez la touche Paging sur la base jusqu'à ce que la tonalité d'activation soit audible (env. 5 sec).

Peu de temps après, le symbole de l'antenne est éclairé, constant, sur l'écran et le combiné est déclaré.

Retirer le combiné

Menu	Appuyez sur touche softkey Menu .
 / 	Sélectionnez Réglages Base et appuyez sur Sélect .
 / 	Sélectionnez Annuler Combiné et appuyez sur Sélect .
	Entrez le PIN actuel et appuyez sur Ok .
 / 	Sélectionnez l'un des combinés indiqués et appuyez sur Sélect .



Le combiné que vous utilisez en ce moment ne peut pas être annulé.

12 Installations à postes supplém. / Services confort

Installations à postes supplémentaires

Si votre téléphone est raccordé à une installation à postes supplémentaires, vous pouvez au moyen de la touche R tirer profit de certaines fonctions comme par ex. le transfert d'appels et le rappel automatique. Veuillez lire le mode d'emploi de votre installation à postes supplémentaires pour connaître le temps de flash à paramétrer pour tirer profit de ces fonctions. Votre revendeur, auprès duquel vous avez acheté l'installation, vous informera si votre téléphone fonctionne impeccablement sur ce genre d'installation. Merci de penser le cas échéant, pour les entrées dans le répertoire, au code d'identification et à la pause parfois nécessaire lui succédant (appuyer longuement sur le chiffre « 0 »).

Services confort

Votre téléphone supporte les services confort de votre opérateur, comme par ex. le va-et-vient, la signalisation d'appel en instance et la conférence. Via la touche R vous pouvez tirer profit de ces services confort. Veuillez demander à votre opérateur quel temps de flash vous devez paramétrer pour tirer profit des services confort. Adressez-vous également à lui pour la déconnexion de ces services.

13 Structure du menu

Liste des appels	Ajouter au rép. Effacer Tout effacer
Répertoire	Voir Ajouter Editer Effacer Tout effacer Etat répertoire
Heure/Alarme	Date & Heure Format date Format Heure Réglage Date Réglages Heure Alarme Alarme On / Alarme Off / Sonnerie alarme
Réglages Combiné	Réglages audio Vol. H-parleur Volume d'écoute Réglages sonn. Sonnerie Interne Sonnerie Externe Volume Sonnerie Alertes Sonores Bip touches On / Off Batterie faible On / Off Hors Portée On / Off Langue Deutsch / English / Française / Italiano Renommer combiné Contraste Niveau 1-5 Réponse auto On / Off Choix base Rég. CB Défaut

Réglages Base	Annuler Combiné
	Réglages sonn. Sonnerie
	Volume Sonnerie
	Numérotation FV / DC
	Touche R Court / Medium / Long
	Modifier PIN
	Rég. défaut base
Association	
Répondeur	Lire
	Tout effacer
	Mémo
	Rép. On/Off
	Rég. Répondeur
	Mode Répondeur
	Langue Rép.
	Régl. annonces
	Nb de Sonneries
	Temps Enregist.
	Filtrage Base
	Code d'interro
	Modifier PIN

14 Recherche erronée

Si vous avez des problèmes avec votre téléphone, contrôlez d'abord les indications suivantes. En cas de problèmes techniques, vous pouvez vous adresser à notre hotline de service en appelant le numéro 0900 00 1675 en Suisse (frais Swisscom à la date d'impression de ce manuel : CHF 2.60/min). Si vous jouissez des droits de garantie, adressez-vous à votre revendeur. La durée de la garantie est de 2 ans.

- Après activation de la touche décrocher, aucune tonalité n'est audible, la ligne d'appel n'est pas occupée.
 - Contrôler la fiche du raccordement téléphonique de la base et de la prise de téléphone.
 - Contrôler la prise réseau à la base et les 230 V.
 - La ligne d'appel est occupée par un autre combiné. Patientez jusqu'à ce que la liaison soit terminée.
- Affichage de l'écran : **Recherche**
 - Contrôler la prise réseau à la base et les 230 V.
 - Réduire distance.
 - Déclarer combiné.
- Aucun affichage sur l'écran.
 - Combiné désactivé -> activer.
 - Pile vide -> recharger.

Configuration d'origine/Etat à la livraison

Liste d'appels:	vide
Repertoire:	vide
Alarme:	éteint
Sonnerie combine:	Externe Melodie 1 Interne Melodie 2 Vol. sonnerie 3
Sonnerie base	Melodie 1 Vol. sonnerie 3
Alertes son.:	Bips touches: en service Batt. faible: en service Hors portée: en service
Langue:	Allemand
Nom combine:	DFT 1471
Reponse auto:	en service
Date & Heure:	Format date: JJ-MM-AAAA Format heure: 24 heures
Mode de numerotation:	Tonalité
Temps Flash:	Court (100 ms)
PIN:	0 0 0 0
Repondeur:	en service
Langue repondeur:	Allemand
NB sonneries:	6 sonneries
Mode repondeur:	Rep. enreg.
Tmps. enreg.:	120 s
Code interro:	en service
Filtrage:	en servic
PIN code interro:	0 0 0 0

15 Caractéristiques techniques

Standard ::	DECT / GAP
Puissance d'émission: 10 mW (puissance moyenne par canal)	
Portée:	jusqu'à 300 mètres en champ libre, jusqu'à 50 mètres à l'intérieur d'un bâtiment
Alimentation en courant de la base:	100~240 V _{AC} / 50/60 Hz / 150 mA, 6 V _{DC} / 450 mA
Alimentation de courant chargeur :	100~240 V _{AC} / 50/60 Hz / 150 mA, 6 V _{DC} / 300 mA
Alimentation en courant du combiné :	NiMH pack de piles rechargeables / 2,4 V / 500 mAh
Durée de service combiné : en veille / en communication:	500 mAh : env. 100 h / env. 10 h
Temps de charge des piles rechargeables: env. 15 heures	
Conditions ambiantes admissibles pour le fonctionnement du combiné: 5°C jusqu'à 40°C ; 20 % jusqu'à 75 % d'humidité relative	
Conditions ambiantes admissibles pour le fonctionnement de la base: 5°C jusqu'à 40°C ; 20 % jusqu'à 75 % d'humidité relative	
Température de stockage admissible: -10°C jusqu'à +60°C	
Processus de numérotation: MFV / IWV Fonction touche R: Flash (100 ms / 300 ms / 600 ms)	

Déclaration de conformité

Cet appareil répond aux exigences des directives de l'union européenne (UE) :

- 1999/5/CE Directive sur les installations de radio et de télécommunication et la reconnaissance réciproque de leur conformité.
- 2005/32/CE Directive « Produits consommateurs d'énergie ».
- Règlement 1275/2008 « Consommation d'électricité en mode veille et en mode arrêt ».
- Règlement 278/2009 « Sources d'alimentation hors charge et leur rendement moyen en mode actif ».

La conformité avec les directives mentionnées ci-dessus est confirmée sur l'appareil par la marque CE.

Pour obtenir toute la déclaration de conformité, veuillez utiliser le téléchargement gratuit de notre site Internet www.switel.com.



Remarques d'entretien

- Nettoyez les surfaces du boîtier avec un chiffon doux et non pelucheux.
- N'utilisez pas de produits d'entretien ou de solvants.

16 Garantie

Les appareils SWITEL sont fabriqués selon les procédés les plus modernes et sont contrôlés. Des matériels sélectionnés et des technologies de pointe ont pour effet un fonctionnement irréprochable et une longue durée de vie. La garantie ne rentre pas en jeu si l'exploitant du réseau téléphonique ou une installation à postes supplémentaires éventuellement intercalée est responsable du dysfonctionnement de l'appareil. La garantie n'est pas valable pour les piles, piles rechargeables ou packs de piles utilisés dans le produits. La durée de la garantie est de 24 mois, à partir de la date d'achat.

Pendant la durée de la garantie, tous les défauts, dus à des vices de matériel ou de fabrication, seront éliminés gratuitement. Le droit à la garantie expire en cas d'intervention de l'acheteur ou de tiers. Les dommages provenant d'un maniement ou d'une manipulation incorrects, d'une mauvaise mise en place ou d'une mauvaise conservation de l'appareil, d'un raccordement non conforme ainsi que d'un cas de force majeure ou autres influences extérieures, sont exclus de la garantie.

Nous nous réservons le droit, en cas de réclamations, de réparer ou de remplacer les composants défectueux ou d'échanger l'appareil. Les composants remplacés ou les appareils échangés deviennent notre propriété. Les demandes de dommages et intérêts sont exclues tant qu'elles ne reposent pas sur l'intention ou une négligence grossière du fabricant. Si votre appareil devait malgré tout présenter une défectuosité pendant la période de garantie, veuillez vous adresser, muni de la quittance d'achat, exclusivement au magasin où vous avez acheté votre appareil SWITEL. Vous ne pouvez faire valoir vos droits à la garantie selon ces dispositions qu'auprès de votre revendeur exclusivement. Deux ans après l'achat et la remise de nos produits, il n'est plus possible de faire valoir les droits à la garantie.

1	Indicazioni di sicurezza	72
2	Mettere in funzione il telefono	73
3	Elementi di comando	76
4	Informazioni introduttive	77
5	Compiere telefonate	80
6	Funzioni speciali	84
7	Elenco chiamate / Ripetizione di selezione	85
8	Rubrica telefonica	86
9	Impostazioni Telefono	87
10	Segreteria telefonica	92
11	Registrare/cancellare un'unità portatile	97
12	Impianti telefonici interni / Servizi aggiuntivi	98
13	Struttura di menu	99
14	Localizzazione guasti	101
15	Dati Tecni	103
16	Garanzia	104

1 Indicazioni di sicurezza

Leggere attentamente le presenti istruzioni per l'uso.

Impiego conforme agli usi previsti

Il presente telefono consente di svolgere telefonate all'interno di una rete telefonica. Qualsiasi altro impiego è considerato come non conforme agli usi previsti. Non sono consentite modifiche o trasformazioni non autorizzate. Non aprire per nessuna ragione l'apparecchio autonomamente, né compiere riparazioni di propria iniziativa.

Luogo di installazione

Evitare l'esposizione a fumo, polvere, vibrazioni, sostanze chimiche, umidità, eccessivo calore o irradiazioni solari dirette.

Non utilizzare l'unità portatile in aree esposte al rischio di deflagrazione.

Alimentatore di rete



Attenzione: Utilizzare solo l'alimentatore a spina fornito in dotazione visto che altri alimentatori di rete potrebbero addirittura danneggiare il telefono. Non ostacolare il libero accesso all'alimentatore a spina con mobili o altri oggetti simili.

Accumulatore ricaricabile



Attenzione: Non gettare batterie ricaricabili nel fuoco. Utilizzare esclusivamente l'accumulatore ricaricabile fornito all'interno della confezione. Osservare la corretta polarità! Pericolo di esplosione durante il caricamento della batteria in caso di errata polarità.

Caduta di tensione

In caso di caduta di tensione non è possibile compiere chiamate con il telefono. Si consiglia di ricorrere in caso di emergenza ad un telefono con filo in grado di funzionare anche senza alimentazione elettrica esterna.

Apparecchiature mediche



Attenzione: Non utilizzare il telefono in prossimità di apparecchiature mediche. Non è possibile escludere il subentro di eventuali interferenze.

Telefoni DECT¹ - possono causare un fastidioso ronzio in apparecchi acustici.

¹DECT: Digital Enhanced Cordless Telecommunication = Standard per telefoni senza cavo

Smaltimento

Procedere allo smaltimento dell'apparecchio esaurito consegnandolo presso uno dei punti di raccolta istituiti dalla propria società di smaltimento rifiuti comunale (ad es. centro di riciclo materiali). Secondo quanto previsto dalla legge sugli apparecchi elettrici ed elettronici, i proprietari di apparecchi esauriti sono per legge tenuti alla consegna di tutti gli apparecchi elettrici ed elettronici presso un centro di rilievo rifiuti in raccolta differenziata. Il simbolo riportato qui a lato indica che non è assolutamente consentito smaltire l'apparecchio assieme ai normali rifiuti domestici!



Accumulatori e batterie possono provocare danni alla salute e all'ambiente!



Non aprire, danneggiare, ingerire o disperdere nell'ambiente accumulatori e batterie. Questi possono contenere metalli pesanti nocivi e dannosi per l'ambiente. Per legge sussiste l'obbligo di consegnare accumulatori e batterie presso i rivenditori di batterie utilizzando gli appositi contenitori di raccolta e provvedendo in tal modo al corretto smaltimento. Lo smaltimento è gratuito. I simboli indicano che non è assolutamente consentito gettare accumulatori e batterie nei rifiuti domestici, consegnandoli ai fini dello smaltimento nei rispettivi punti di raccolta.

Smaltire confezioni ed imballaggi in base a quanto indicato dalle norme in vigore a livello locale.

2 Mettere in funzione il telefono

Indicazioni di sicurezza



Attenzione: Prima della messa in funzione, leggere attentamente le indicazioni di sicurezza riportate al capitolo 1.

Verificare il contenuto della confezione

La confezione contiene:

Contenuto	DFT 147X-Modello			
	DFT 1471	DFT 1472	DFT 1473	DFT 1474
Stazione base con alimentatore di rete	1	1	1	1
Stazione di carica con alimentatore	-	1	2	3

Contenuto	DFT 147X-Modello			
	DFT 1471	DFT 1472	DFT 1473	DFT 1474
Unità portatile	1	2	3	4
Cavo di collegamento telefonico	1	1	1	1
Accumulatore ricaricabile	1	2	3	4
Istruzioni per l'uso	1	1	1	1

Potenza assorbita

La potenza assorbita dalla stazione base ammonta a:

- in servizio (stand-by/conversazione): ca. 1,5 W

- durante la carica dell'unità mobile: ca. 2,5 W.

Il carico nullo de circuito di alimentazione rete è pari a circa 0,15 W.

L'efficienza media è pari a circa il 65 %.

La potenza assorbita dalla stazione di carica ammonta a:

- senza unità mobile: ca. 0,15 W

- durante la carica dell'unità mobile: ca. 1,2 W.

Il carico nullo de circuito di alimentazione rete è pari a circa 0,15 W.

L'efficienza media è pari a circa il 60 %.

Collegare la stazione base



Attenzione: Montare la stazione base con una distanza minima di 1 m da altri apparecchi elettronici in modo da evitare interferenze reciproche.

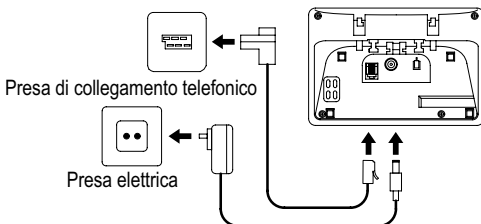

Procedere al collegamento della stazione base seguendo quanto raffigurato nella figura. Utilizzare per motivi di sicurezza solo l'alimentatore di rete oltre che il cavo di collegamento telefonico forniti in dotazione.



Attenzione: Utilizzare per la stazione base, solo l'alimentatore fornito in dotazione.

Inserire l'accumulatore ricaricabile

Spingere il coperchio del vano accumulatore in basso, quindi rimuoverlo. Innestare il connettore dell'accumulatore ricaricabile nella presa presente all'interno del vano accumulatore. Inserire l'accumulatore ricaricabile nell'apposito vano. Utilizzare esclusivamente l'accumulatore ricaricabile fornito. Fare attenzione a non incastrare il cavo. Riposizionare il coperchio sul vano accumulatore spingendolo verso sopra fino a quando scatta in posizione.

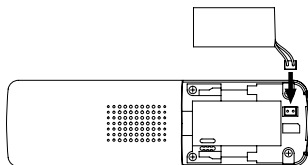

Caricare l'accumulatore ricaricabile



Riporre l'unità portatile in sede di prima messa in funzione per minimo 15 ore nell'unità base / stazione di carica.

L'unità portatile si surriscalda durante il processo di carica. Questo è un fenomeno normale e non pericoloso. Evitare di caricare l'unità portatile con dispositivi di carica differenti o estranei. Lo stato di carica attuale è visualizzato sul display. Quando il livello di carica della batteria è sceso al limite, sul display lampeggia il simbolo della batteria .

Impostare ora e data dell'unità portatile

All'accensione l'unità portatile non dispone di un'impostazione oraria corretta (per esempio: per le registrazioni nell'elenco chiamate/segreteria telefonica). Impostate data e ora nel menu **Ora/Sveglia > Data e ora**.

Impostare la lingua di display

La lingua di display può essere impostata in 4 diverse lingue. Il telefono è impostato su "Tedesco". Modificare la lingua nel menu "MT einstellen > Sprache" **Imposta Port. > Lingua**.

Accettazione di chiamata automatica / Risposta dir

L'attivazione di questa funzione consente di ricevere automaticamente una chiamata estraendo semplicemente l'unità portatile dalla stazione base. L'accettazione di chiamata automatica è attivata o disattivata nel menu **Imposta Port. > Risposta Autom.**

3 Elementi di comando

I tasti del telefono riportati nel presente manuale d'istruzioni sono raffigurati sotto forma di simboli uniformi all'interno di un riquadro. Sono possibili lievi scostamenti dei simboli dei tasti sul telefono rispetto ai simboli qui raffigurati.

Unità portatile

- 1 Altoparlante
- 2 Display
- 3 Aumento volume /
Tasti di navigazione
- 4 Tasto softkey
- 5 Elenco chiamate /
Tasti di navigazione
- 6 Tasto di Fine chiamata /
Spegnimento
- 7 Ripetizione di chiamata /
Riduzione volume
Tasti di navigazione
- 8 Tasto # /
Disattivare il tono chiamata
- 9 Tasto R (flash)
- 10 Tasto Interno
- 11 Mikrofono
- 12 Tasto Viva Voce
- 13 Tasto * /
Blocco tastiera
- 14 Tasti numerici
- 15 Tasto di chiamata
- 16 Tasti di navigazione
- 17 Tasto softkey

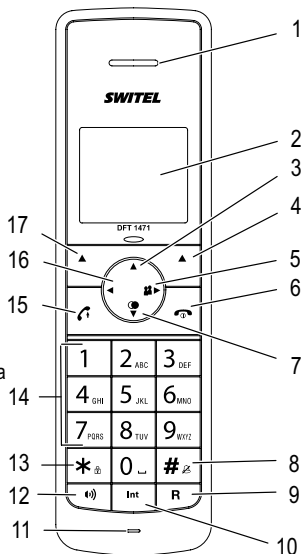

Stazione base

1 LED: visualizzazione di chiamata

2 Volume + 

3 Volume - 

4 Cancellare 

5 Display

6 Messaggio successivo 

7 Segreteria telefonica on/off 

8 Riproduzione/Stop 

9 Ripetizione messaggio / Messaggio precedente 

10 Cercare l'unità portatile (funzione di paging) 

11 Altoparlante



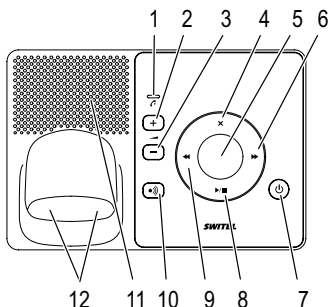





12 Contatti di carica





















4 Informazioni introduttive

In questo capitolo sono riportate le principali informazioni riguardo l'uso delle presenti istruzioni e del telefono.

Modi di rappresentazione delle istruzioni per l'uso

	Premere il tasto raffigurato
2 sec. 	Premere il tasto raffigurato per 2 secondi
	Inserire numeri o lettere
	L'unità portatile squilla
	Stazione base squilla
	Estrarre l'unità portatile dalla stazione base
	Riporre l'unità portatile nella stazione base
Sveglia	Rappresentazione di testi sul display
	Rappresentazione di simboli sul display





Simboli sul display dell'unità portatile

Simbolo	Descrizione
	Costante: Collegamento con la stazione base. Lampeggiante: Il collegamento con la stazione base si interrompe.
	Costante: Indicazione dello stato di carica delle batterie. Segmenti che scorrono quando l'unità portatile è collegata all'unità base: le batterie ricaricabili sono in fase di carica.
GG-MM	Visualizzazione della data  pagina 87.
HH:MM	Visualizzazione dell'ora  pagina 87.
	La funzione vivavoce è attivata.
	Costante: Funzione allarme inserita. Lampeggiante: Allarme  pagina 88.
	Costante: Chiamata in corso. Lampeggiante: Chiamata in arrivo.
	E' in corso una chiamata interna (solo con più unità portatili registrate su una sola base)  pagina 82. Chiamata interna in arrivo.
	Con un messaggio dell'elenco chiamate: Nuova Chiamata. Durante la riproduzione dei messaggi dalla segreteria telefonica: Nuovo messaggio.
	Il blocco tastiera è attivato  pagina 84.
Microfono Off	Microfono in modalità silenziamento  pagina 82.
	La segnalazione acustica di chiamata è disinserita  pagina 84.
	La segreteria telefonica è collegata  pagina 93.



Nelle seguenti descrizioni del display vengono visualizzate le funzioni disponibili per entrambi i **softkey** a seconda della modalità.

Menu	Aprire il Menu.
Rubri.	Accesso alla Rubrica.
Selez	Selezionare tra le voci del menu evidenziate.
OK	Confermare una selezione.
Indiet	Ritornare al livello precedente del menu o terminare la funzione.
Canc	Tornare indietro-cancellare le voci inserite (una pressione breve cancella gli ultimi segni, una pressione più lunga cancella l'intera riga).

Tasti di navigazione

	Nel menu/negli elenchi (Rubrica, Elenco chiamate, Ripetizione di selezione): sfogliare verso l'alto. Nel corso di una chiamata: alzare il volume.
	Durante la modifica di una voce/durante una selezione: spostare il cursore a sinistra.
	In modalità stand-by: aprire l'elenco chiamate. Durante la modifica di una voce/ durante una selezione: spostare il cursore a destra.
	In modalità stand-by: aprire l'elenco delle ripetizioni di selezione. Nel corso di una chiamata: abbassare il volume. Nel menu/negli elenchi (rubrica, elenco chiamate, ripetizione di selezione): sfogliare verso il basso.

Funzioni speciali di alcuni tasti

	Nell'immissione di un numero di telefono: inserire una pausa di selezione tenendo premuto.
	In modalità stand-by: accendere/spengere il tasto asterisco tenendo premuto il tasto. Nell'inserimento di un nominativo: scorrere la tabella dei caratteri (Latino/Russo/Greco) tenendo premuto il tasto, vedi le tabelle in appendice. Nel corso di una comunicazione: per passare temporaneamente alla selezione a toni quando è attivata la selezione ad impulsi.

In modalità stand-by: attivare/disattivare il tono chiamata dell'unità portatile tenendo premuto il tasto. Nell'inserimento di un nominativo: passare da maiuscolo a minuscolo e viceversa tenendo premuto il tasto.

Modalità di stand-by



In tutte le descrizioni del presente manuale di istruzioni si considera l'unità portatile in modalità di stand-by. Per passare alla modalità di stand-by, premere il tasto .

Riduzione delle radiazioni (modalità ECO)

La radiazioni risultano considerevolmente ridotte sia in modalità conversazione che in modalità di stand-by con modalità ECO inserita rispetto ad un telefono cordless a standard DECT.



Navigazione nel menu



I differenti menu consentono di raggiungere tutte le funzioni del telefono. La struttura completa del menu si trova in appendice. Per la navigazione nel menu utilizzare le softkeys ed i tasti freccia. Utilizzando i Softkeys a sinistra **Menu** si accede al menu. Utilizzare i tasti freccia  e  per navigare all'interno del menu. Per aprire un sottomenu premere il tasto **Selez.** Per ritornare al livello del menu precedente premere **Indiet.** Tornare in modalità stand-by tenendo premuto il tasto di fine chiamata. .

5 Compiere telefonate



Ricevere una chiamata

  Il telefono suona.

L'unità portatile **non** si trova inserita nell'unità base:

 /  Premere il tasto di risposta o il vivavoce.

L'unità portatile non si trova inserita nell'unità base e la **Risposta Autom. non** è inserita:

 /  Sollevare l'unità portatile dall'unità base e premere il tasto di risposta o il vivavoce.

L'unità portatile non si trova inserita nell'unità base e la **Risposta Autom.** è inserita:

 E' sufficiente prelevare l'unità portatile dall'unità base; la conversazione sarà automaticamente accettata.

Telefonare



Immettere un numero di chiamata.
In caso di immissione errata, correggere **Canc.**

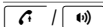

Il numero di chiamata viene selezionato.



E' altresì possibile premere prima il tasto di chiamata e ricevere il segnale di linea libera. Le cifre immesse per la composizione del numero desiderato verranno così selezionate. Con questo tipo di funzione chiamata non è possibile correggere le singole cifre che compongono il numero di chiamata.

Concludere una chiamata



Premere il tasto di fine chiamata o riporre l'unità portatile sull'unità base.

Ripetizione di selezione



Il telefono memorizza gli ultimi 10 numeri composti. Se il numero è stato inserito nella rubrica del telefono, apparirà il nome memorizzato con quel numero. Per visualizzare il numero corrispondente al nome premere il tasto **Selez.**



Aprire l'elenco di ripetizione di chiamata.



Selezionare la voce.

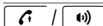

Il numero di chiamata viene selezionato.

Per chiamare un numero dall'elenco chiamate



Il vostro telefono memorizza le ultime 20 chiamate nell'elenco chiamate. Se il numero è stato inserito nella rubrica del telefono, apparirà il nome memorizzato con quel numero. Per visualizzare il numero corrispondente al nome premere il tasto **Selez.**

La memorizzazione può avvenire solo, se sulla vostra connessione è disponibile "l'identificazione del numero di chiamata (CLIP)" e se il numero di chi telefona non è trattenuto o non è trasmesso per altri motivi.



Aprire l'elenco chiamate.



Selezionare la voce.

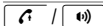

Il numero di chiamata viene selezionato.

Effettuare delle chiamate dalla rubrica



La rubrica può contenere fino a 50 voci.
Per immettere una voce vedere la sezione „Rubrica Telefonica“.

Rubri. Aprire la rubrica telefonica.

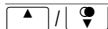

Selezionare la voce.

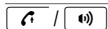

Il numero di chiamata viene selezionato.

Visualizzazione della durata di conversazione

Durante lo svolgimento di una chiamata, la durata della telefonata è visualizzata in ore, minuti e secondi.

Impostare il volume del ricevitore



Il volume è regolabile durante lo svolgimento di una chiamata in 5 livelli (dal ricevitore -> volume ricevitore, dal viva voce -> volume altoparlante).

Le impostazioni sono separate tra di loro e rimangono memorizzate anche una volta terminata la conversazione.

Silenziamento del microfono nell'unità portatile

MicOff Durante la conversazione è possibile disattivare il microfono, per fare in modo che il vostro interlocutore non vi possa sentire.
Sul display apparirà **Microfono Off**.



Mic ON Per attivare il microfono premere il tasto ripristina.

Compiere chiamate interne







Le conversazioni interne, trasferimenti di chiamata e teleconferenze sono possibili solo quando sono registrate più unità portatili. Se non è questo il caso, sul display verrà visualizzato **Non Disponibile**.







Int

Premere il softkey **Int**. Se sono registrate due unità portatili, verrà chiamato subito l'altra unità portatile. Se sono registrate più unità portatili, vengono visualizzati i relativi numeri interni (per esempio 2 3 4). Selezionare con i tasti freccia  /  l'unità portatile desiderata e confermare con **Selez.** Selezionare "9" per chiamare contemporaneamente tutti i telefoni collegati.







Trasferire chiamate esterne

	Nel corso di una chiamata esterna. . .
	Premere il tasto  Selezionare con i tasti freccia  /  l'unità portatile desiderata e confermare con Selez. La chiamata esterna verrà trattenuta. Se l'unità portatile chiamata è accesa, verrà eventualmente annunciata la comunicazione.
	Premere il tasto di fine chiamata. La chiamata è stata trasmessa.

Conversazione intermedia

	Nel corso di una chiamata esterna. . .
	Premere il tasto  Selezionare con i tasti freccia  /  l'unità portatile desiderata e confermare con Selez. La chiamata esterna verrà trattenuta.
	Passare da un interlocutore all'altro con il tasto  .

Teleconferenza

	Nel corso di una chiamata esterna. . .
	Premere il tasto  Selezionare con i tasti freccia  /  l'unità portatile desiderata e confermare con Selez. La chiamata esterna verrà trattenuta.
	Tenere premuto il tasto  finchè non appare Conferenza sul display.



Se uno dei partecipanti alla teleconferenza riattacca, gli altri partecipanti rimangono connessi fra di loro.

6 Funzioni speciali

Blocco tastiera



Il blocco tastiera impedisce la digitazione involontaria dei tasti. Le chiamate in arrivo possono essere ricevute come di consueto.

*_☎

Tenere premuto il tasto asterisco fino a quando appare sul display il simbolo del blocco tastiera.

*_☎

Per sbloccare la tastiera tenere premuto nuovamente il tasto asterisco fino a quando il simbolo non scompare di nuovo.

Disattivare il tono chiamata sull'unità portatile



E' possibile disattivare il tono chiamata anche sul menu **Imposta Port. > Imposta Suoneria > Volume Suonerie.**

#_☎

Tenere premuto il tasto cancelletto fino a quando il simbolo di disattivazione tono chiamata  non appare sul display.

#_☎

Per riattivare il tono chiamata tenere premuto nuovamente il tasto cancelletto fino a quando non riappare il simbolo.

Spegnimento unità portatile



Per risparmiare la batteria spegnere l'unità portatile.







Tenere premuto il tasto di fine chiamata. Dopo alcuni secondi l'unità portatile si spegnerà. L'illuminazione del display si spegnerà.







Per riaccendere l'unità portatile tenere premuto il tasto di fine chiamata fino a quando non si avverte un segnale acustico e fino a quando il display non si illuminerà di nuovo.

7 Elenco chiamate / Ripetizione di selezione

Modificare l'elenco chiamate

	Accedere all'elenco chiamate.
 / 	Selezionare una voce e premere il softkey Selez per visualizzare data e ora della chiamata.
Menu	Premere il softkey Menu .
 / 	Selezionare una delle seguenti opzioni e confermare con Selez :
Agg a Rubrica	Il numero di chiamata verrà memorizzato nella rubrica. Se è inserito un nome, confermare o modificare il numero di telefono ed associare una suoneria per questa voce della rubrica.
Cancella	La voce verrà eliminata a seguito di un'ulteriore richiesta di conferma.
Cancella tutto	L'intera rubrica verrà eliminata a seguito di un'ulteriore richiesta di conferma.

Modificare ripetizione di selezione









	Accedere alla ripetizione di selezione.
 / 	Selezionare una voce e premere il softkey Selez .
Menu	Premere il softkey Menu .
 / 	Selezionare una delle seguenti opzioni e confermare con Selez :
Agg a Rubrica	Il numero di chiamata verrà memorizzato nella rubrica. Se è inserito un nome, confermare o modificare il numero di telefono ed associare una suoneria per questa voce della rubrica.
Cancella	La voce verrà eliminata a seguito di un'ulteriore richiesta di conferma.
Cancella tutto	L'intera rubrica verrà eliminata a seguito di un'ulteriore richiesta di conferma.

8 Rubrica telefonica







Nella rubrica è possibile memorizzare fino a 50 numeri di telefono e relativi nomi. E' possibile associare ad ogni voce una suoneria, con la quale verrà segnalata la chiamata. Immettere sempre il numero di telefono con il relativo prefisso; questo permetterà una corretta visualizzazione del corrispondente chiamante, per il quale è stata inserita una voce nella rubrica e per il quale sulla vostra connessione è disponibile la trasmissione del numero.

Aggiungere una nuova voce alla rubrica

Menu	Premere il softkey Menu .
 / 	Selezionare Rubrica e confermare con Selez.
 / 	Selezionare Aggiungi e confermare con Selez.
	Immettere il nome (al max. 12 caratteri). Le cifre si immettono con i tasti carattere. Premendo più più volte il tasto relativo è possibile inserire caratteri e cifre. Passare da maiuscolo a minuscolo e viceversa tenendo premuto il tasto #. Dopo una breve attesa il cursore procede automaticamente. Terminare l'immissione del nome con OK .
	Inserire il numero di telefono (max. 24 cifre). Se il telefono è collegato ad un impianto telefonico interno, è necessario selezionare un numero di accesso alla rete esterna. Se occorre una pausa di selezione, premere il tasto 0 per circa 2 secondi dopo aver inserito il numero di accesso alla rete esterna; sul display apparirà la lettera P . Terminare l'immissione del nome con OK .
 / 	Selezionare una suoneria per la nuova voce della rubrica.
Selez	Confermare con Selez.







Modificare le voci della rubrica

Menu	Premere il softkey Menu .
 / 	Selezionare Rubrica e confermare con Selez.
 / 	Selezionare una delle seguenti opzioni e confermare con Selez. :

Leggi	Per visualizzare tutte le voci della rubrica. Sfogliare l'elenco fino alla voce desiderata. Premere Selez per visualizzare Nome, Numero di Telefono e Suoneria. Modificare o eliminare la voce con Menu .
Aggiungi	Per aggiungere una nuova voce alla rubrica.
Modifica	Tutte le voci della rubrica vengono visualizzate. Sfogliare l'elenco fino alla voce desiderata. Per modificare una voce premere Selez . Eliminare caratteri e cifre con Canc , inserire con i tasti cifra dei nuovi caratteri e nuove cifre. Per ulteriori dettagli consultare "Immettere nuova voce".
Cancella	Tutte le voci della rubrica vengono visualizzate. Sfogliare l'elenco fino alla voce desiderata. Premendo Selez la voce verrà eliminata.
Cancella tutto	Premendo Selez tutta la rubrica verrà eliminata dopo un'ulteriore richiesta di conferma.
Stato Rubrica	Verrà visualizzata la situazione attuale della rubrica (per esempio (z. B. 7 / 50 Occup. : sono disponibili 7 voci su 50 della rubrica).

9 Impostazioni Telefono

Data/Ora













Menu	Premere il softkey Menu .
 / 	Selezionare Ora/Sveglia e premere Selez .
 / 	Selezionare Data e ora e premere Selez .
 / 	Selezionare una delle seguenti opzioni e confermare con Selez .
Formato data	Per impostare il formato data: (GG-MM-AAAA oppure MM-GG-AAAA).
Formato Ora	Per impostare il formato ora: (24 ore oppure 12 ore).
Imposta Data	Immettere la data con i tasti cifra.
Imposta Ora	Immettere l'ora con i tasti cifra. Per immettere l'ora nel formato 12 ore, passate da „AM“ a „PM“ con i tasti asterisco.









In caso di interruzione dell'alimentazione elettrica l'impostazione verrà persa, se contemporaneamente l'unità portatile è disattivata o le batterie sono scariche.



Sveglia

Menu	Premere il softkey Menu .
 / 	Selezionare Ora/Sveglia e premere Selez.
 / 	Selezionare Sveglia e premere Selez.
 / 	Selezionare Sveglia Attiva e premere Selez.
	Inserire l'ora della sveglia con i tasti cifra e premere OK .
 / 	Selezionare Snooze On o Snooze Off e premere Selez. Se Snooze è inserito, significa che l'allarme della sveglia verrà ripetuto dopo 2 minuti, fino a quando la funzione verrà disattivata tenendo premuto il tasto di fine chiamata. Se Snooze non è inserito, l'allarme della sveglia verrà emesso solo una volta all'ora impostata. Per arrestare l'allarme della sveglia premere un tasto qualsiasi.
 / 	Selezionare Melodia Sveglia e premere Selez.
 / 	Selezionare una suoneria e premere Selez.







Impostare l'audio dell'unità portatile

Menu	Premere il softkey Menu .
 / 	Selezionare Imposta Port. e premere Selez.
 / 	Selezionare Imposta Audio e premere Selez.
 / 	Selezionare una delle seguenti opzioni e confermare con Selez :
Volume altoparl.	Selezionare il volume di riproduzione vivavoce.
Volume auricol.	Selezionare il volume per l'auricolare.









E' possibile regolare queste impostazioni anche nel corso di una conversazione semplicemente tramite i tasti freccia (vedi „Compiere telefonate / Impostare il volume del ricevitore“).

Impostare il tono di chiamata dell'unità mobile







Menu	Premere il softkey Menu .
 / 	Selezionare Imposta Port. e premere Selez.
 / 	Selezionare Imposta Suoneria e premere Selez.
 / 	Selezionare una delle seguenti opzioni e confermare con Selez :

Suonerie Int.	Selezionare una suoneria per la segnalazione di una chiamata interna.
Suoneria esterna	Selezionare una suoneria per la segnalazione di una chiamata esterna.
Volume Suoneria	Selezionare il volume per il tono chiamata. Se viene selezionato Volume Off ,  apparirà sul display il simbolo relativo.





Impostazione toni di avviso

Menu	Premere il softkey Menu .
 / 	Selezionare Imposta Port. e premere Selez.
 / 	Selezionare Imposta Toni e premere Selez.
 / 	Selezionare una delle seguenti opzioni e confermare con Selez :
Tono Tasti	Attivare o disattivare il tono dei tasti.
Attenzione	Attivare o disattivare il tono di avviso che segnala quando la batteria deve essere ricaricata.
Fuori portata	Attivare o disattivare il tono che segnala quando l'unità portatile si trova fuori dalla copertura del segnale dell'unità base.

Impostazione lingua del display





Menu	Premere il softkey Menu .
 / 	Selezionare Imposta Port. e premere Selez.
 / 	Selezionare Lingua e premere Selez.
 / 	Selezionare una lingua e confermare con Selez.

Impostare nome dell'unità portatile







Menu	Premere il softkey Menu .
 / 	Selezionare Imposta Port. e premere Selez.
 / 	Selezionare Nome Portatile e premere Selez.
	Eliminare il vecchio nome con Canc , inserire il nuovo nome con i tasti cifra e premere OK .

Regolare il contrasto







Menu	Premere il softkey Menu .
 / 	Selezionare Imposta Port. e premere Selez.

 / 	Selezionare Contrasto e premere Selez.
 / 	Selezionare il contrasto desiderato e premere Selez.

Impostazione Risposta automatica

Menu	Premere il softkey Menu .
 / 	Selezionare Imposta Port. e premere Selez.
 / 	Selezionare Risposta Autom. e premere Selez.
 / 	Selezionare se la risposta automatica deve essere attivata o disattivata e premere Selez.





Selezionare l'unità base

Menu	Premere il softkey Menu .
 / 	Selezionare Imposta Port. e premere Selez.
 / 	Selezionare Selezione Base e premere Selez.
 / 	Viene visualizzato un elenco di unità base alle quali l'unità portatile è stata registrata. L'unità base attualmente attiva è demarcata da un „*“. Selezionare un'unità base e premere Selez.



Vengono visualizzate solo le unità base a cui l'unità portatile è già stata.







Reimpostare l'unità portatile come da impostazioni predefinite

Menu	Premere il softkey Menu .
 / 	Selezionare Imposta Port. e premere Selez.
 / 	Selezionare Reset Portatile e premere Selez.
	Inserire il codice PIN attuale e premere OK . Confermare anche la successiva richiesta di conferma con OK .



Le registrazioni nella rubrica telefonica e messaggi sulla segreteria telefonica non vengono cancellati.

Impostazione Suoneria per l'unità base

Menu	Premere il softkey Menu .
 / 	Selezionare Imposta Base e premere Selez.
 / 	Selezionare Imposta Suoneria e premere Selez.
 / 	Selezionare una delle seguenti opzioni e confermare con Selez. :

Suonerie	Selezionare una suoneria per l'avviso di una chiamata.
Volume Suoneria	Selezionare il volume o spegnere il tono di avviso.







Impostazione modalità di selezione

Menu	Premere il softkey Menu .
 / 	Selezionare Imposta Base e premere Selez.
 / 	Selezionare Modo Composiz. e premere Selez.
 / 	Selezionare Toni o Decadica e confermare con Selez.









Per la maggior parte degli impianti telefonici, l'impostazione giusta è **Toni**.

Impostazione tempo flash

Menu	Premere il softkey Menu .
 / 	Selezionare Imposta Base e premere Selez.
 / 	Selezionare Tempo flash e premere Selez.
 / 	Selezionare Breve (100 ms), Medio (300 ms) oppure Lungo (600 ms) e confermare con Selez.





Modificare PIN

Menu	Premere il softkey Menu .
 / 	Selezionare Imposta Base e premere Selez.
 / 	Selezionare Cambia PIN e premere Selez.
	Inserire il codice PIN attuale (nella configurazione predefinita 0 0 0 0) e premere OK .
	Inserire un nuovo codice PIN e premere OK .
	Inserire un nuovo codice PIN ancora una volta e premere OK .



Il codice PIN a quattro cifre protegge alcune impostazioni da un accesso non autorizzato. Nel caso non si dovesse ricordare il codice PIN, rivolgersi al nostro Servizio di Assistenza.

Reimpostare l'unità base come da impostazioni predefinite

Menu	Premere il softkey Menu .
 / 	Selezionare Imposta Base e premere Selez.
 / 	Selezionare Reset imp predef e premere Selez.



Inserire il codice PIN attuale e premere **OK**.
Confermare anche la successiva richiesta di conferma con **OK**.



Le voci che si trovano nella rubrica non verranno eliminate.
L'unità portatile registrata rimane registrata.

10 Segreteria telefonica

La segreteria telefonica digitale integrata contiene fino a 15 minuti di messaggi, a seconda del grado di compressione impostato per annunci e messaggi. Possono essere contenuti fino a 59 messaggi.

I promemoria inseriti vengono trattati come messaggi.

La segreteria telefonica può servirsi sia dell'unità base che dell'unità portatile. Con un telefono multifrequenza è inoltre possibile un accesso remoto alla segreteria telefonica protetto da codice PIN.

Esistono due modalità di selezione:

- annuncio con registrazione di messaggio
- solo annuncio.

Nella configurazione predefinita è già memorizzato un annuncio standard per ciascuna modalità. La segreteria telefonica è quindi pronta per l'utilizzo. Nella modalità „annuncio con registrazione di messaggio“, al raggiungimento della capacità di incisione massima, l'apparecchio passa automaticamente alla modalità “Solo annuncio”.

Se la segreteria telefonica è disinserita, dopo circa 10 chiamate verrà riprodotto solo il testo dell'annuncio per la modalità „solo annuncio“.

Sul display dell'unità mobile il simbolo corrispondente indica che la segreteria telefonica è inserita.

Nell'ascolto del messaggio sull'unità portatile vengono ogni volta indicate la data e l'ora dell'arrivo del messaggio, se sono state impostate correttamente (Menu: **Ora/Sveglia / Data e ora**).

Il display sull'unità base fornisce, a seconda della modalità, le seguenti informazioni:

--	Trattini costantemente accesi: segreteria telefonica spenta. Lampeggiante: la segreteria telefonica è inserita, l'ora non è impostata (per il primo utilizzo).
XX	Cifre illuminate: quantità vecchi messaggi Cifre lampeggianti: quantità nuovi messaggi.
LA	Lampeggiante: viene dato l'accesso alla segreteria telefonica da un'unità portatile o con un telefono tramite accesso remoto o comando a distanza.

A1/A2	Il messaggio viene ascoltato. (A1= Annuncio con registrazione di messaggio / A2 = solo annuncio).
FF	Lampeggiante: la memoria della segreteria telefonica è piena.
Lx	Impostazione del volume della segreteria telefonica sull'unità base: x= visualizzazione del volume attuale.

I nuovi messaggi vengono contrassegnati da un simbolo ★ al momento dell'ascolto.





Resettando le configurazioni predefinite del telefono vengono cancellati i propri annunci e tutti i messaggi esistenti.

Esercizio presso la base

Sull'unità base è possibile inserire/disinserire la segreteria telefonica, ascoltare e cancellare messaggi. Potete trovare le funzioni del tasto corrispondente al capitolo "Elementi di comando" riportato all'inizio di questa guida.

Inserire/Disinserire la segreteria telefonica (unità portatile)

Menu	Premere il softkey Menu .
 / 	Selezionare Segreteria e premere Selez.
 / 	Selezionare TAM On/Off e premere Selez.
 / 	Selezionare On o Off e premere Selez. Il simbolo appare sul display quando viene inserita la segreteria telefonica..



Registrare annunci

Menu	Premere il softkey Menu .
 / 	Selezionare Segreteria e premere Selez.
 / 	Selezionare Imposta Segr e premere Selez.
 / 	Selezionare Imposta Risposta e premere Selez.
 / 	Selezionare Solo risposta per la modalità „solo annuncio" o Risp & Registra per la modalità "annuncio con registrazione di messaggio" e premere Selez.
 / 	Selezionare Registra e premere Selez. Sul display appare l'indicazione "In Registrazione". Registrare l'annuncio al microfono e premere OK alla fine della registrazione. L'annuncio verrà trasmesso.





Ascoltare annuncio

Menu	Premere il softkey Menu .
 / 	Selezionare Segreteria e premere Selez.
 / 	Selezionare Imposta Segr e premere Selez.
 / 	Selezionare Imposta Risposta e premere Selez.
 / 	Selezionare Solo risposta per la modalità „solo annuncio“ o Risp & Registra per la modalità “annuncio con registrazione di messaggio” e premere Selez.
 / 	Selezionare Ascolta messaggi e premere Selez. Il messaggio verrà ascoltato.

Eliminare i propri annunci

Menu	Premere il s Menu .
 / 	Selezionare Segreteria e premere Selez.
 / 	Selezionare Imposta Segr e premere Selez.
 / 	Selezionare Imposta Risposta e premere Selez.
 / 	Selezionare Solo risposta per la modalità „solo annuncio“ o Risp & Registra per la modalità “annuncio con registrazione di messaggio” e premere Selez.
 / 	Selezionare Predefinito e premere Selez. I propri annunci personali verranno eliminati.

Ascoltare messaggi/cancellare singoli messaggi

Menu	Premere il softkey Menu .
 / 	Selezionare Segreteria e premere Selez.
 / 	Selezionare Ascolta messaggi e premere Selez. Accendere l'altoparlante dell'unità portatile per ascoltare i messaggi.

Nel corso della riproduzione sono possibili le seguenti opzioni:

 / 	Selezionare il volume di riproduzione.
---	--



Menu	Premere Menu , selezionare con i tasti freccia e confermare con Selez : <ul style="list-style-type: none">- Stop, per terminare la riproduzione.- Successivo, per riprodurre il messaggio successivo.- Precedente, per ritornare al messaggio precedente o all'inizio del messaggio corrente.- Cancella, per eliminare il messaggio corrente.
-------------	--







Queste funzioni possono essere eseguite anche con i tasti cifra:

- Tasto 5: terminare la riproduzione
- Tasto 6: messaggio successivo
- Tasto 4: messaggio precedente o inizio messaggio corrente (premere due volte il tasto 4).
- Tasto 2: eliminare il messaggio corrente.

Eliminare tutti i vecchi messaggi

Menu	Premere il softkey Menu .
 / 	Selezionare Segreteria e premere Selez.
 / 	Selezionare Cancella tutto e premere Selez. Tutti i vecchi messaggi (già ascoltati) verranno eliminati dopo una richiesta di conferma.

Registrare un promemoria

Menu	Premere il softkey Menu .
 / 	Selezionare Segreteria e premere Selez.
 / 	Selezionare Registra e premere Selez. Registrate la vostra comunicazione con il microfono e poi premere OK . La comunicazione verrà trasmessa.









Se durante la registrazione o durante l'ascolto si preme **Canc**, il memo viene cancellato.

Accettare una conversazione dalla segreteria telefonica

E' possibile intercettare una chiamata già accettata dalla segreteria telefonica, per parlare direttamente con la persona in linea.

	Premere il tasto di risposta.
---	-------------------------------

Impostazioni Segreteria Telefonica

Menu	Premere il softkey Menu .
 / 	Selezionare Segreteria e premere Selez.
 / 	Selezionare Imposta Segr e premere Selez.
 / 	Selezionare una delle seguenti opzioni e confermare con Selez.
Modo risposta	Impostare la modalità per la segreteria telefonica.
Lingua segr.	Selezionare la lingua per l'annuncio standard.
Imposta Risposta	Registrare il testo dell'annuncio/ascoltare il testo dell'annuncio.



Ritardo Risposta	Selezionare con i tasti freccia il tempo di risposta di una chiamata della segreteria telefonica: - 2 Squilli (2...9 Squilli): Risposta dopo x squilli - Salva Tempo : Se ci sono nuovi messaggi, la segreteria telefonica risponde dopo due squilli. Se non ci sono nuovi messaggi, la segreteria risponde dopo sei squilli. E' possibile quindi fare una verifica con l'accesso remoto se ci sono nuovi messaggi o se non c'è stata nessuna comunicazione.
Tempo Registr.	Selezionare con i tasti freccia il tempo disponibile per la comunicazione (60 s, 120 s, 180 s, indefinito).
Base Sto filtr	Attivare l'ascolto dei messaggi in arrivo sull'unità base con On o Off . Se l'ascolto è attivato è possibile ascoltare il chiamante mentre lascia il suo messaggio. Se si desidera accettare la conversazione subito, premere il tasto di chiamata o il vivavoce. Se non si desidera essere disturbati dalla telefonata, disattivare l'ascolto.
Accesso Remoto	Inserire l'accesso remoto On oppure Off .
Cambia PIN rem	Inserire un codice PIN per l'accesso remoto (nella configurazione predefinita 0 0 0 0). Questo codice PIN è necessario, quando viene effettuato un accesso remoto/comando a distanza da un telefono multifrequenza.

Accesso remoto/comando a distanza

E' possibile effettuare un accesso remoto/comando a distanza da un telefono multifrequenza. Selezionare il numero di telefono dell'impianto telefonico. Se la segreteria telefonica è inserita, il messaggio parte dopo 10 squilli. Se la segreteria non è inserita, il messaggio parte a seconda del tempo di risposta impostato. Premere di tasto asterisco ***#** nel corso del messaggio e immettere il codice PIN dell'accesso remoto. Dopo l'inserimento corretto del codice PIN, sono a disposizione le seguenti funzioni.



La comunicazione viene interrotta se dopo tre tentativi viene inserito un codice PIN errato.







5	Avviare o terminare la riproduzione.
4	Riascoltare il messaggio corrente. Premere il tasto due volte, per passare al messaggio precedente.
6	Ascoltare il messaggio successivo.
2	Löscht die aktuelle Nachricht.
8	Terminare la riproduzione.

7	Inserire la segreteria telefonica.
9	Disinserire la segreteria telefonica.







11 Registrare/cancellare un'unità portatile

Su una stazione base possono essere registrate fino a 5 unità portatili. Le unità portatili fornite con il vostro telefono sono già registrate con l'unità base. Per registrare un'unità mobile „estranea“ si prega di consultare il manuale di istruzioni.

Registrare un'altra unità mobile dello stesso tipo

Menu	Premere il softkey Menu .
 / 	Selezionare Affiliazione e premere Selez.
 / 	Selezionare una stazione base e premere Selez. Le stazioni base a cui il portatile è già collegato sono rappresentate in vettoriale. La base in uso è contrassegnata con un *.
	Inserire l'attuale codice PIN dell'unità di base sulla quale deve essere registrata l'unità portatile e premere OK .
	Tenere premuto il tasto Paging nell'unità base fino a quando non viene emesso un tono che indica che la registrazione è avvenuta (ca. 5 sec.).
	Poco dopo si illumina costantemente sul display il simbolo dell'antenna e l'unità portatile è così registrata.

Cancellare un'unità portatile

Menu	Premere il softkey Menu .
 / 	Selezionare Imposta Base e premere Selez.
 / 	Selezionare Cancella Port. e premere Selez.
	Inserire il codice PIN attuale e premere OK .
 / 	Selezionare una delle unità portatili registrate e premere Selez.



L'unità portatile in uso non può essere cancellata.

12 Impianti telefonici interni / Servizi aggiuntivi

Impianti telefonici interni

Avendo collegato il telefono ad un impianto telefonico interno, il tasto R consente di accedere a tutte le altre funzioni disponibili come per es. trasferimento di chiamata e funzione di richiamata automatica. Si prega di consultare le istruzioni per l'uso del proprio impianto telefonico interno per individuare il tempo flash da impostare al fine di poter usufruire di queste funzioni. Il rivenditore autorizzato è in grado di indicare se il telefono acquistato funzionerà senza alcun problema nel proprio impianto telefonico interno. Si consiglia di inserire le voci della rubrica con l'eventuale numero di accesso alla rete esterna e la pausa di selezione necessaria (premere a lungo "0").

Servizi aggiuntivi

Il telefono supporta servizi aggiuntivi messi a disposizione dal proprio gestore di rete telefonica come per es. le funzioni di chiamata in attesa, avviso di chiamata e chiamata a conferenza. Il tasto R consente di accedere a questi servizi aggiuntivi. Si prega di consultare il proprio gestore di rete telefonica per ottenere informazioni sul tempo flash necessario all'utilizzo dei servizi aggiuntivi. Rivolgersi al proprio gestore di rete telefonica per ottenere l'abilitazione ai servizi aggiuntivi.

13 Struttura di menu

Liste Chiamate	Agg a Rubrica Cancella Cancella tutto	
Rubrica	Visualizza Aggiungi Modifica Cancella Cancella tutto Stato Rubrica	
Ora/Sveglia	Data e ora	Formato data Formato Ora Imposta Data Imposta Ora Sveglia
	Sveglia	Sveglia Attiva / Sveglia Disatt. / Melodia Sveglia
Imposta Port.	Imposta Audio	Volume altoparl. Volume auricol.
	Imposta Suoneria	Suonerie Int. Suoneria esterna Volume Suonerie
	Imposta Toni	Tono Tasti On / Off Batteria Scarica On / Off Fuori portata On / Off
	Lingua	Deutsch / English / Française / Italiano
	Nome Portatile	
	Contrasto	Livello 1-5
	Risposta Autom.	On / Off
	Selezione Base	
	Reset Portatile	

Imposta Base	Cancella Port.	Suonerie
	Imposta Suoneria	Volume Suoneria
	Modo Composiz.	Toni / Decadica
	Tempo flash	Breve / Medio / Lungo
	Cambia PIN	
	Reset imp predef	
Affiliazione		
Segreteria	Ascolta messaggi	
	Cancella tutto	
	Registra	
	TAM On/Off	
	Imposta Segr	Modo risposta
		Lingua segr.
		Imposta Risposta
		Ritardo Risposta
		Tempo Registraz.
		Base Sto filtr
		Accesso Remoto
		Cambia PIN rem

14 Localizzazione guasti

In presenza di problemi con il telefono, seguire le indicazioni riportate qui di seguito. In caso di problemi tecnici è possibile rivolgersi alla nostra hotline di assistenza tecnica chiamando al numero 0900 00 1675 valido per la Svizzera (spese da rete Swisscom alla data di stampa: CHF 2.60 / min). In caso di reclami entro il periodo di garanzia, rivolgersi al rivenditore autorizzato. Il periodo di garanzia ricopre 2 anni.

- Dopo la selezione del tasto di risposta non è udibile alcun segnale acustico, la linea non è occupata.
 - Controllare la spina della connessione telefonica sull'unità base e sulla presa del telefono.
 - Controllare la spina elettrica sull'unità di base e sul 230 V.
 - La linea è occupata da un'altra unità portatile. Attendere fino a quando non è terminata la comunicazione.
- Sul display è visualizzato: **RICERCA**
 - Controllare la spina elettrica sull'unità di base e sul 230 V.
 - Ridurre la portata.
 - Cancellare l'unità portatile.
- Nessuna visualizzazione sul display.
 - Unità portatile spenta -> accenderla.
 - Batterie scariche -> caricare le batterie.

Impostazioni predefinite/Configurazioni predefinite

Elenco chiamate:	Vuoto
Rubrica telefonica:	Vuoto
Sveglia:	Disattivato
Suoneria pt:	Interno: Melodia 2 Esterno: Melodia 1 Volume: 3
Suoneria bs:	Melodia 1 Volume: 3
Imposta toni:	Toni tasti: Attivato Toni batt: Attivato Fuoriportata: Attivato
Lingua:	Tedesco
Nome portatile:	DFT 1471
Risposta aut.:	Attivato
Data e ora:	Formato data: GG-MM-AAAA Formato ora: 24 ora
Proc selezione:	Toni
Tempo flash:	Breve (100 ms)
PIN:	0 0 0 0
Segreteria telefonica:	Attivato
Lingua segreteria:	Tedesco
Ritardo risp.:	6 squilli
Mod risposta:	Risp & reg
Tempo reg:	120 s
Accesso rem:	Attivato
Filtro chiam:	Attivato
Accesso rem PIN:	0 0 0 0

15 Dati Tecnici

Standard:	DECT / GAP
Potenza di trasmissione:	10 mW (potenza media per canale)
Copertura:	fino a 300 metri all'aperto, fino a 50 metri all'interno di un edificio
Alimentazione stazione base:	100~240 V _{AC} / 50/60 Hz / 150 mA, 6 V _{DC} / 450 mA
Alimentazione unità di carica:	100~240 V _{AC} / 50/60 Hz / 150 mA, 6 V _{DC} / 300 mA
Alimentazione elettrica unità portatile:	NiMH l'accumulatore ricaricabile / 2,4 V / 500 mAh
Autonomia dell'unità portatile:	in stand-by/in conversazione 500 mAh = ca. 100 h / ca. 10 h
Tempo di carica della batteria:	ca. 15 Ore
Requisiti ambientali ammessi per il funzionamento dell'unità portatile:	5°C - 40°C ; 20 % - 75 % umidità relativa dell'aria
Requisiti ambientali ammessi per il funzionamento dell'unità base:	5°C - 40°C ; 20 % - 75 % umidità relativa dell'aria
Temperatura di conservazione:	-10°C - +60°C
Selezione impostabile:	MFV / IWV Funzione Flash: Flash (100 ms / 300 ms / 600 ms)

Dichiarazione di conformità

Questo apparecchio risponde a quanto disposto dalla Direttiva UE:

- 1999/5/CE Direttiva concernente le apparecchiature radio, le apparecchiature terminali di telecomunicazioni e il reciproco riconoscimento della loro conformità.
- 2005/32/CE Direttiva "Prodotti che consumano energia".
- Regolamento 1275/2008 "Consumo di energia elettrica nei modi stand-by e spento".
- Regolamento 278/2009 "I componenti di rete in caso di peso nullo, nonché la loro efficienza media in funzionamento".

La conformità con la direttiva di cui sopra viene confermata dal marchio CE applicato sull'apparecchio.



Per la dichiarazione di conformità completa si prega di voler usufruire del servizio gratuito di download dal nostro sito Internet www.switel.com.

Consigli per la cura

- Pulire le superfici degli apparecchi con un panno morbido e antipilling.
- Non utilizzare mai detergenti o solventi.

16 Garanzia

Gli apparecchi SWITEL sono costruiti e collaudati in osservanza dei processi di produzione più moderni. L'impiego di materiali selezionati e tecnologie altamente sviluppate sono garanti di una perfetta funzionalità e lunga durata in vita. La garanzia non viene considerata esecutiva qualora la causa del malfunzionamento dell'apparecchio è dovuta al gestore della rete telefonica oppure se questa è da attribuirsi ad un impianto telefonico interno interposto. La garanzia non si estende a batterie, accumulatori o batterie ricaricabili utilizzati all'interno degli apparecchi. Il periodo di garanzia ricopre 24 mesi a partire dalla data di acquisto.

Entro il periodo di garanzia si procederà all'eliminazione gratuita di tutti i guasti dovuti a difetti di materiale o produzione. Il diritto di garanzia cessa in caso di interventi da parte dell'acquirente o di terzi. Danni derivanti da un impiego o esercizio non conforme agli usi previsti, a naturale usura, a errato montaggio o errata conservazione, a collegamento o installazione impropri, dovuti a forza maggiore o ad altri influssi esterni non sono coperti da garanzia. In qualità di produttore ci riserviamo il diritto, in caso di reclami, di riparare o sostituire le parti difettose o di rimpiazzare l'apparecchio. Parti o apparecchi sostituiti passano di nostra proprietà. Sono esclusi diritti di risarcimento per danni qualora non siano dovuti a intenzione o colpa grave del costruttore.

Nel caso in cui il presente apparecchio dovesse ciò nonostante presentare un difetto durante il periodo di garanzia, si prega di rivolgersi esclusivamente al negozio di rivendita dell'apparecchio SWITEL assieme al relativo scontrino di acquisto. In base alle presenti disposizioni, tutti i diritti di garanzia dovranno essere fatti valere esclusivamente nei confronti del rivenditore autorizzato. Decorso il termine di due anni dalla data di acquisto e consegna dei nostri prodotti non sarà più possibile fare valere alcun diritto di garanzia.

1	Safety Information	106
2	Preparing the Telephone	107
3	Operating Elements	110
4	Preliminary Information	111
5	Telephoning	114
6	Other features	117
7	Call list / Redial	118
8	Phone book	119
9	Setting the telephone	120
10	Answering Machine	124
11	Registering/de-registering handsets .	129
12	PBX / Supplementary Services	130
13	Menu Structure	131
14	In Case of Problems	133
15	Technical data	134
16	Guarantee	135

1 Safety Information

Please read this operating instruction manual thoroughly.

Intended use

The telephone is suitable for telephoning within a public telephone network system. Any other use is considered unintended use. Unauthorised modification or reconstruction is not permitted. Under no circumstances open the device or complete any repair work yourself.

Installation location

Prevent excessive exposure to smoke, dust, vibration, chemicals, moisture, heat and direct sunlight. Do not use the handset in potentially explosive areas.

Power adapter plug



Attention: Only use the power adapter plug supplied because other power supplies could damage the telephone. Ensure access to the power adapter plug is not obstructed by furniture or such.

Rechargeable batteries



Attention: Never throw batteries into a fire. Only use the battery supplied with the unit. Pay attention to the correct polarity. Incorrect polarity of the battery represents a risk of explosion during charging.

Power failure

The telephone cannot be used to make calls in the event of a power failure. Always keep a cord connected telephone which operates without an external power supply available in case of emergency situations.

Medical equipment



Attention: Never use the telephone in the vicinity of medical equipment. Effects on such equipment cannot be fully ruled out.

DECT¹ telephones can cause an unpleasant humming sound in hearing aids.

¹DECT: Digital Enhanced Cordless Telecommunication = Standard for cordless telephones.

Disposal

In order to dispose of your device, take it to a collection point provided by your local public waste authorities (e.g. recycling centre). According to laws on the disposal of electronic and electrical devices, owners are obliged to dispose of old electronic and electrical devices in a separate waste container. The adjacent symbol indicates that the device must not be disposed of in normal domestic waste.



Risks to health and the environment from batteries!

Never open, damage or swallow batteries or allow them to pollute the environment. They could contain toxic and ecologically harmful heavy metals. You are legally obliged to dispose of power packs and batteries at the point of sale or in the corresponding containers provided at collection points by local public waste authorities. Disposal is free of charge. The above symbols indicate that the batteries must not be disposed of in domestic waste and that they must be disposed of at an authorised collection point.

Packaging materials must be disposed of according to local regulations.

2 Preparing the Telephone

Safety information



Attention: It is essential to read the Safety Information in Chapter 1 before starting up.

Checking the package contents

The package contains:

Content	DFT 147X-model			
	DFT 1471	DFT 1472	DFT 1473	DFT 1474
Base station / power adapter plug	1	1	1	1
Charging station with power adapter plug	-	1	2	3
Handset	1	2	3	4
Telephone connection cable	1	1	1	1
Rechargeable battery pack	1	2	3	4
Operating instructions	1	1	1	1

GB

Electrical consumption

The **electrical consumption of the base** is:

- in operation mode (idle/call): approx. 1.5 W
- during charging of the handset: approx. 2.5 W.

The adaptor input power without load is approx. 0.15 W. The average efficiency is approx. 65 %.

The **electrical consumption of the charger** is:

- without handset charging: approx. 0.15 W
- during charging of the handset: approx. 1.2 W.

The adaptor input power without load is approx. 0.15 W. The average efficiency is approx. 60 %.

Connecting the base station



Attention: Position the base station at least 1 m away from other electronic devices, otherwise there is a risk of mutual disturbance.

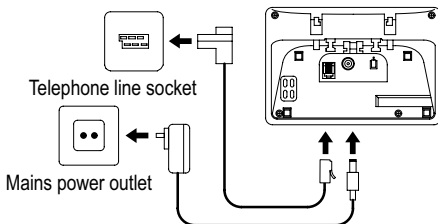

Connect the base station as illustrated in the diagram. For reasons of safety, only use the power adapter plug and telephone connection line supplied.



Attention: Use only the power adapter plug supplied with the base station!

Inserting the battery pack

Slide the battery compartment cover downwards and then remove it. Connect the plug on the battery pack in the socket in the battery compartment. Insert the battery pack in the battery compartment. Only use the battery pack supplied. Pay attention that the cable is not jammed. Replace the cover back on the battery compartment and slide it upwards until it snaps into place.

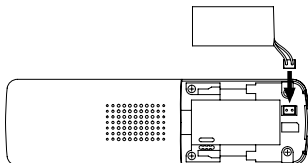

Charging the battery pack



Before the handset is used for the first time, insert it in the base station/charging station for at least 15 hours.

The handset warms up during the charging process. This is normal and does not represent a risk. The current battery charge status is indicated in the display. When the battery pack capacity is nearly exhausted, the battery symbol  will flash in the display.

Setting the time and date on the handset

At initial operation the handset does not have the correct time (e.g. for entries in the call list). Date and time are set through the menu item **Clock/Alarm > Date & Time**.

Setting the display language

The display language is available in 4 languages. The default setting is "German (Deutsch)". Set the language using the menu item "MT einstellen > Sprache" **HS Settings > Language**.

Auto Answer

If this function is activated, an incoming call is taken when the handset is removed from the base station. The automatic answering function is activated and deactivated using the menu item **HS Settings > Auto Answer**.

3 Operating Elements







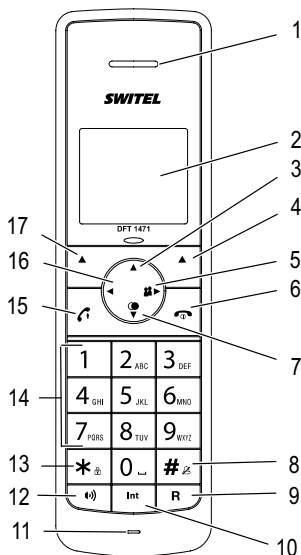

The buttons in this operating manual are subsequently depicted with a uniform contour. Therefore, slight deviations in the appearance of the symbols on the telephone buttons compared to those depicted here are possible.

Handset

- 1 Earpiece
- 2 Display
- 3 Increase volume / Navigation key
- 4 Softkey
- 5 Call list / Navigationkey
- 6 On Hook button / Switch off
- 7 Redialling / Reduce volume Navigation key
- 8 # button / Ringer off
- 9 R-key
- 10 Internal call key
- 11 Microphone
- 12 Handsfree
- 13 * button / Key lock
- 14 Digit keys
- 15 Off Hook button
- 16 Navigation key
- 17 Softkey



Base station



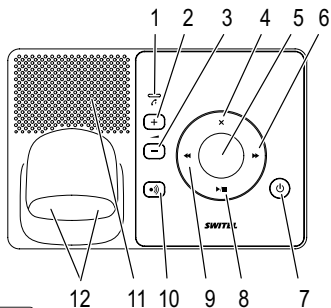





- 1 LED: call indicator
- 2 Volume + 
- 3 Volume - 
- 4 Delete key 
- 5 Display
- 6 Skip 
- 7 TAM on/off 
- 8 Start/Stop 
- 9 Repeat message / Back 
- 10 Locate handset (Paging) 
- 11 Loudspeaker
- 12 Charge contacts





















4 Preliminary Information

This chapter provides basic information on using the operating instruction manual and the telephone.

Description of operating sequences in the manual

	Press the button depicted
2 sec. 	Press the button depicted for 2 seconds
	Enter digits or letters
	Handset rings
	Base station rings
	Remove the handset from the base station
	Place the handset in the base station
Alarm	Depicts text in the display
	Depicts icons in the display





Icons in the handset display

Icon	Description
	On: The connection to the base station is good. Flashing: The connection to the base station is lost.
	On: Indicates the battery charge status. Scrolling while handset in base: Battery is being charged.
DD-MM	Displays the date;  Page 120.
HH:MM	Displays the time;  Page 120.
	Handsfree mode is activated.
	On: The alarm function is activated. Flashing: The alarm is ringing.  Page 120.
	On: A call is currently being made. Flashing: A call has been received.
	You can conduct an internal call (only with several handsets registered on the base station);  Page 116. Incoming internal call.
	While browsing call list: New call. While playback from the answering machine: New message.
	The key lock is activated;  Page 117.
Call Muted	The microphone is muted;  Page 116.
	The ringing tone has been switched off;  Page 117.
	Answering machine is on;  Page 125.



The functions assigned to the two **softkeys** are shown in the lowest line of the display. The key function changes automatically according to the operating status of the handset.

Menu	Accessing the menu.
PB	Accessing the phonebook.
Select	Selecting the respective entry/menu item.
OK	Confirmation.
Back	Back to the previous menu or cancel programming.
Clear	Backwards deleting of characters during entry (brief pressing deletes one character, long pressing deletes the whole line).

Functions of the arrow keys

	In menu mode / in lists (phonebook, caller list, redial list): Press to scroll up. During a call: Press to increase volume.
	In editing / pre-dial mode: Press to move the cursor one character to the left.
	In idle mode: Press to access the call list. In editing / pre-dial mode: Press to move the cursor one character to the right.
	In idle mode: Press to access the redial list. During a call: Press to decrease volume. In menu mode / in lists (phonebook, caller list, redial list): Press to scroll down.

Special key functions

	While entering a telephone number: a long press inserts a dialling pause.
	In idle mode: a long press will activate/deactivate keypad lock. In editing mode: a long press switches the character set (Latin/Russian/Greek), tables -> appendix. During a call: temporary switch to DTMF if pulse is activated.
	In idle mode: a long press turns on/off the handset ringer. In editing mode: a long press toggles between uppercase and lowercase character input.

Standby mode

All descriptions in this operating manual assume that the handset is in Standby mode. The system switches to Standby mode by pressing the  button.

Low-radiation operation (ECO mode)

Both in Call mode as well as in Standby mode, the radiation is reduced considerably when ECO mode is activated as compared to standard, cordless DECT telephones.





Navigating in the menu

All the functions can be accessed via the various menus. The entire menu structure can be found in the appendix.

The softkeys and the arrow keys are used for navigation in the menu.

The menu is opened with the left softkey **Menu**.

Use the arrow keys  and  to move within the menu.



Press the softkey **Select** to open a sub menu.

Press **Back** to go back to the previous level.



By pressing the On-hook key  you will return to standby state.

5 Telephoning



Taking a call

  Your phone is ringing.

If the handset is **not** in the base station:

 /  Press the Off Hook button or the Handsfree button.

If the handset is in the base station and **Auto Answer** is **not** activated:

 /  Remove the handset from the base and press the Off Hook button or the Handsfree button.

If the handset is in the base station and **Auto Answer** is activated:

 Remove the handset from the base - the call will be taken automatically.

Making a call

 Enter the telephone number.
Delete wrong characters pressing **Clear**.

 /  The telephone number is being dialled.



You can also press the Off Hook button and you will hear the dialling tone. The entered number will be dialled immediately. It is not possible to correct wrong digits individually using this dialling procedure.

Ending a call



Press the On Hook button or replace the handset in the base station.

Redial



Your handset saves the last 10 dialled telephone numbers. If a caller is stored in your phone book, the name will be displayed. Whilst the name is displayed to show the respective number press **Select**.



Open the redial list.

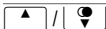

Select an entry.

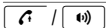

Dial out the telephone number.

Making a call from the call list



Your handset saves the numbers of the last 20 incoming calls in the call list. If a caller is stored in your phone book, the name will be displayed. Whilst the name is displayed to show the respective number press **Select**.

Saving can only take place if the function "Phone number transmission (CLIP)" is available at your connection and caller ID is not suppressed by the caller or was not transmitted for any other reason.



Open the call list.



Select an entry.



Dial out the telephone number.

Making a call from the phone book



You can store up to 50 entries in the phone book. For creating entries see section "Phone book".

PB

Open the telephone book.

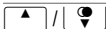

Select the name of the person you wish to call.

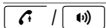

Dial out the telephone number.

Call timer

Your handset automatically times the duration of every call in hours, minutes and seconds.

Setting the earpiece/loudspeaker volume

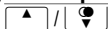

During a call you can adjust the volume in 5 levels (if telephoning "normally" -> earpiece volume, with hands-free -> loudspeaker volume). These separate settings will remain at the last selected level when you end the call.

Muting the microphone



Mute	During a call you can switch your handset's microphone off. The display shows Call Muted .
Unmute	To unmute press the softkey again.

Internal calls



Internal calls, transfers and conference calls are only possible if multiple handsets are registered. If this is not the case **Not Available** will be indicated on the display.



Int

Press the **Int** key. If two handsets are registered to the base station the other handset will be called immediately. If three or more handsets are registered to the base station their internal numbers will be displayed (for example 2 3 4). Use the arrow keys  /  to select the handset and press **Select**. If you select "9" in the case of several registered handsets all will be called at the same time.

Transferring an external call to another handset

During an external call . . .

Int

Press the **Int** key.
Select the handset using the arrow keys  / 
and press **Select**.
The external call is put on hold. When the called handset answers you can announce the call transfer.





Press the On-Hook key. The call will be transferred.

Broker's call

During an external call . . .

Int

Press the **Int** key.

Select the handset using the arrow keys  /  and press **Select**.

The external call is put on hold.

Int



Use the **Int** key to switch between the calls.

3-Party Conference

During an external call . . .

Int

Press the **Int** key.

Select the handset using the arrow keys  /  and press **Select**.

The external call is put on hold.

Int

Press and hold the **Int** key until **Conference** appears in the display.



Any handset hangs up during a conference call will leave the other handset still in connection with the external call.

6 Other features

Key lock



The key lock prevents functions assigned to buttons being activated inadvertently. Incoming calls can still be taken in the normal way even when the key lock function is activated.

***_☎**

Press and hold down the star-key until the key lock icon appears in the display.

***_☎**

For unlocking the keypad again press and hold down the star-key until the icon disappears.

Switching the handset ringer on/off



You can turn off the ringer via the menu item **HS Settings > Ring Setup > Ring Volume >** as well.

#_☎

Press and hold down the #-key until the  icon appears in the display.

#_☎

For turning the ringer on again press and hold down the #-key until the icon disappears.

Switching off the handset



You can switch off the handset for saving battery capacity.



Press and hold down the On Hook-button. After a few seconds the handset will be switched off. The display illumination goes down.



For switching the handset on again press and hold down the On Hook-button until you hear a short beep and the display is illuminated.

7 Call list / Redial

Editing the call list



Open the call list.



Select an entry and press **Select**.
The respective call's date and time is shown.

Menu

Press the **Menu** softkey.



Select one of the following options and confirm with **Select**:

Add to PB

The telephone number will be stored in the telephone book. Enter a name, confirm or edit the telephone number and select a ringtone melody for the entry.

Delete

The entry will be deleted.

Delete All

The complete list will be deleted after a confirmation query.

Editing the redial list



Open the redial list.



Select an entry and press **Select**.

Menu

Press the **Menu** softkey.



Select one of the following options and confirm with **Select**:

Add to PB

The telephone number will be stored in the telephone book. Enter a name, confirm or edit the telephone number and select a ringtone melody for the entry.

Delete

The entry will be deleted.

Delete All

The complete list will be deleted after a confirmation query.









8 Phone book







Your phone can store up to 50 private phonebook entries with names and numbers. You can also select different ringtones for your phonebook entries.

Always enter the phone numbers with the area code; this enables a correct display of the respective caller for whom there is an existing entry and whose phone number transmission to your connection is available.

Creating a new entry

Menu	Press the Menu softkey.
 / 	Select Phonebook and press Select .
 / 	Select Add if necessary and press Select .
	Enter the name (max. 12 digits). Letters are also imprinted on the digit keys. Letters, digits and special characters are entered by pressing the relevant key the respective number of times. A long press on the #-key toggles between uppercase and lowercase character input. After a short time the cursor skips one position forwards. Having entered the name press OK .
	Enter the phone number (max. 24 digits). If your telephone is connected to a PBX start the telephone number with the access code. If a dialling pause is needed, press after the access code the 0 key for approx. 2 sec. a P appears in the display. Having entered the number press OK .
 / 	Select a melody for the entry.
Select	Confirm with Select .



Editing telephone book entries

Menu	Press the Menu softkey.
 / 	Select Phonebook and press Select .
 / 	Select one of the following options and confirm with Select :
Read	All entries are shown. Scroll to the desired entry. Press Select to view the details of the selected entry. Press Menu to edit or delete the entry.

Add	You can create a new entry.
Edit	All entries are shown. Scroll to the desired entry. Press Select to edit the selected entry. Use the Cancel , softkey to delete characters and numbers then add new characters and numbers as required. Please refer to "Creating a new entry".
Delete	All entries are shown. Scroll to the desired entry. Press Select to delete the entry immediately.
Delete All	Press Select to delete all entries after a confirmation query.
PB Status	The current allocation will be displayed (e.g. 7 / 50 Used : 7 of 50 possible entries are present).

9 Setting the telephone





Date/Time



Menu	Press the Menu softkey.
	Select Clock/Alarm and press Select .
	Select Date & Time and press Select .
	Select one of the following options and confirm with Select .
Date Format	You can select your desired date format: (DD-MM-YYYY or MM-DD-YYYY).
Time Format	You can select your desired time format: (24 or 12 hours).
Set Date	Enter the date using the digit keys.
Set Time	Enter the time using the digit keys. If entering the time using a 12 hour clock then use the star key to select AM or PM.







In case of mains failure this setting will be deleted when simultaneously the handset is switched off or the battery is empty.







Alarm

Menu	Press the Menu softkey.
	Select Clock/Alarm and press Select .
	Select Alarm and press Select .
	Select Alarm On and press Select .
	Enter the alarm time using the digit keys and press OK .

 / 	Select Snooze On or Snooze Off and press Select . If Snooze Snooze is turned on it means that the alarm signal is being repeated after 2 minutes until this function is terminated by pressing and holding the off hook button. If Snooze is turned off the alarm signal is given once at the specified time. To confirm the alarm signal, press any key.
---	---

 / 	Select Alarm Melody and press Select .
 / 	Select a melody and press Select .







Handset Audio Setup

Menu	Press the Menu softkey.
 / 	Select HS Settings and press Select .
 / 	Select Audio Setup and press Select .
 / 	Select one of the following options and confirm with Select :
Speaker Volume	Select the volume for handsfree operation.
Ear Volume	Select the volume for the earpiece.









These settings can also be made during a call (-> "Telephoning / Setting the earpiece/loudspeaker volume").

Setting the ringer for the handset







Menu	Press the Menu softkey.
 / 	Select HS Settings and press Select .
 / 	Select Ring Setup and press Select .
 / 	Select one of the following options and confirm with Select :
Internal Ring	Select a melody for internal calls.
External Ring	Select a melody for external calls.
Ring Volume	Select the volume. If you select Volume Off , the respective icon  appears in the display.

Setting the alert tones





Menu	Press the Menu softkey.
 / 	Select HS Settings and press Select .
 / 	Select Tone Setup and press Select .

 / 	Select one of the following options and confirm with Select :
Key Tone	Switch the keytone on or off.
Warning	Switch the alert tone on or off. The tone sounds if "Low battery" is detected.
Out of Range	Switch the alert tone on or off. The tone sounds if "Out of range" is detected.







Setting the display language

Menu	Press the Menu softkey.
 / 	Select HS Settings and press Select .
 / 	Select Language and press Select .
 / 	Select a language and press Select .







Setting the handset name

Menu	Press the Menu softkey.
 / 	Select HS Settings and press Select .
 / 	Select Rename HS and press Select .
	Delete the old name with Clear , enter a new name using the digit keys and confirm with OK .



Setting the display contrast





Menu	Press the Menu softkey.
 / 	Select HS Settings and press Select .
 / 	Select Contrast and press Select .
 / 	Select a contrast level and press Select .

Setting Auto Answer

Menu	Press the Menu softkey.
 / 	Select HS Settings and press Select .
 / 	Select Auto Answer and press Select .
 / 	Select whether the automatic answer function will be on or off and confirm with Select .

Select a base station





Menu	Press the Menu softkey.
 / 	Select HS Settings and press Select .

 / 	Select Select Base and press Select .
 / 	You see a list of base stations your handset is already registered to. The relevant base is marked with a ** . Select a base and press Select .



Only base stations are shown your handset is already registered to.







Resetting the handset

Menu	Press the Menu softkey.
 / 	Select HS Settings and press Select .
 / 	Select HS Default and press Select .
	Enter the relevant PIN (default 0 0 0 0) and press OK . Confirm the confirmation query with OK .









The entries in phonebook or TAM messages will not be deleted.

Setting the ringer for the base station

Menu	Press the Menu softkey.
 / 	Select Base Settings and press Select .
 / 	Select Ring Setup and press Select .
 / 	Select one of the following options and confirm with Select :
Ring Melody	Select a melody.
Ring Volume	Select the volume.



Setting the dial mode





Menu	Press the Menu softkey.
 / 	Select Base Settings and press Select .
 / 	Select Dial Mode and press Select .
 / 	Select Tone or Pulse and press Select .









In most situations the **Tone** option should be selected.

Setting the Flash Time

Menu	Press the Menu softkey.
 / 	Select Base Settings and press Select .

 / 	Select Flash Time and press Select .
 / 	Select Short (100 ms), Medium (300 ms) or Long (600 ms) and confirm with Select .





Editing the PIN

Menu	Press the Menu softkey.
 / 	Select Base Settings and press Select .
 / 	Select Modify PIN and press Select .
	Enter the relevant PIN (default 0 0 0 0) and press OK .
	Enter a new PIN and press OK .
	Enter the new PIN again and press OK .



The four digit PIN protects some settings against unauthorized changes. If you have forgotten your PIN please call our service hotline.

Resetting the base station

Menu	Press the Menu softkey.
 / 	Select Base Settings and press Select .
 / 	Select BS Default and press Select .
	Enter the relevant PIN (default 0 0 0 0) and press OK . Confirm the confirmation query with OK .



The entries in phonebook will not be deleted.
The registration of handsets will not be changed.

10 Answering Machine

The integrated digital answering machine offers a total recording time of up to 15 minutes for outgoing and incoming messages. A maximum of 59 messages can be taken.

Self recorded memos are treated like messages.

You can access the answering machine from the base station as well as from the handset. Using a telephone with tone dialling (DTMF) you have also a PIN protected remote access.

You can select between two modes:

- Answer and record
- Answer only.

A standard announcement is already saved for every operating type at the delivery stage. Therefore the answering machine is immediately operational. At "Answer and record" and reaching of the maximum recording capacity the device will automatically switch to the operating type "Answer only". If the answering machine is turned off the announcement for the operating type "Answer only" will be played after approx. 10 rings.

You can see from the corresponding symbol on the display of the handset that the answering machine is turned on.

When listening messages through the handset date and time of the respective message will be shown. For this reason date and time have to be set correctly (menu: **Clock/Alarm / Date & Time**).

The display on the base station shows the operating state and gives you further information:

--	Dashes steadily on: Answering machine is off. Flashing: Answering machine is on, date/time not set (on first use).
XX	Digits steadily on: Number of old (already heard) messages. Flashing digits: Number of new messages.
LA	Flashing: Remote access in progress (handset or remote phone)
A1/A2	Playing outgoing message (A1=Answer & Record, A2=Answer only).
FF	Flashing: TAM memory is full.
Lx	While setting the TAM-volume on the base: x=volume level.

New messages are being indicated by the symbol ★ in the display of the handset.







At resetting the base station to the delivery state all own announcements as well as existing messages will be deleted.

Accessing the answering machine through the base

Through the base station you can turn the answering machine on or off, playback and delete messages. For the respective function please refer to the chapter "Operating elements" in this user guide.

Turning the answering machine on/off from the handset

Menu	Press the Menu softkey.
 / 	Select Answer Machine and press Select .
 / 	Select TAM On/Off and press Select .



Select **On** or **Off** and confirm with **Select**.
When set to **On** the respective icon appears in the display.

Recording outgoing message

Menu

Press the **Menu** softkey.



Select **Answer Machine** and press **Select**.



Select **TAM Settings** and press **Select**.



Select **OGM Settings** and press **Select**.



Select **Answer Only** for the “answer-only mode” or **Answer & Record** for the “answer and record mode” and press **Select**.



Select **Record** and press **Select**. “Recording” is displayed.

Speak your message to the handset’s microphone and press **OK** at the end of the recording. Playback of your outgoing message will start.

Playback outgoing message

Menu

Press the **Menu** softkey.

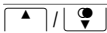

Select **Answer Machine** and press **Select**.



Select **TAM Settings** and press **Select**.

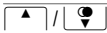

Select **OGM Settings** and press **Select**.



Select **Answer Only** for the “answer-only mode” or **Answer & Record** for the “answer and record mode” and press **Select**.



Select **Playback** and press **Select**.

Playback of the outgoing message will start.

Deleting the personal outgoing message

Menu

Press the **Menu** softkey.



Select **Answer Machine** and press **Select**.



Select **TAM Settings** and press **Select**.



Select **OGM Settings** and press **Select**.



Select **Answer Only** for the “answer-only mode” or **Answer & Record** for the “answer and record mode” and press **Select**.



Select **Default** and press **Select**.
Your personal outgoing message will be deleted.

Listen new messages / deleting single messages

Menu Press the **Menu** softkey.



Select **Answer Machine** and press **Select**.



Select **Playback** and press **Select**.
The loudspeaker on the handset will be switched on and the playback will start.

During playback you have the following options:



You can set the playback volume.

Menu Press **Menu**, select one of the following options using the up/down key and press **Select**:

- **Stop**, to stop the playback.
- **Next**, to skip to the next message.
- **Previous**, to go back to the previous message or to begin the relevant message again.
- **Delete**, to delete the relevant message.



These options you can access via the digit keys as well. Press:

- key 5: to stop playback.
- key 6: to skip to the next message.
- key 4: to begin the relevant message again or to go back to the previous message (press key 4 twice).
- key 2: to delete the relevant message.

Deleting all old messages

Menu Press the **Menu** softkey.

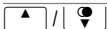

Select **Answer Machine** and press **Select**.

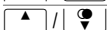

Select **Delete All** and press **Select**.
All old (already heard) messages will be deleted after a confirmation query.

Recording a memo

Menu Press the **Menu** softkey.



Select **Answer Machine** and press **Select**.

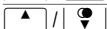

Select **Memo** and press **Select**.
Speak your memo to the handset's microphone and press **OK**. Playback of your memo will start.



Drücken Sie während der Aufnahme oder während des Abspielens **Cancel**, wird das Memo gelöscht.

Taking a call from the answering machine

It is possible to intercept a call even if the answering machine has already begun to take it. So you can talk with the person who called.



Press the Off Hook button.

Setting the answering machine







Menu	Press the Menu softkey.
	Select Answer Machine and press Select .
	Select TAM Settings and press Select .
	Select one of the following options and press Select .
Answer Mode	Select the answering machine mode.
TAM Language	Select the language for the default outgoing message.
OGM Settings	Record/playback/delete outgoing messages.
Answer Delay	Use the up/down key to select the delay for answering the call: - 2 Rings (2 ... 9 rings): Call will be answered after x rings. - Time Saver : If new messages are available, the answering machine will answer after two rings. If no new messages are available the call will be answered after six rings. Therefore you can check remotely whether or not new messages are available without having to make a connection.
Recording Time	Use the up/down key to set the maximum length of the recording time for incoming messages (60 s, 120 s, 180 s, unlimited).
Base Screening	Switch the screening of incoming messages via the base station loudspeaker On or Off . This feature allows you to listen to the caller whilst they are recording their message. Then if you want to intercept the call lift the handset and press the Off Hook button. If you do not wish to be disturbed by calls then set this feature to Off.
Remote Access	Switch remote access On or Off .
Chg Remote PIN	Enter the remote access PIN (default 0 0 0 0). This PIN is needed for remote accessing the answering machine from a tone-dialling (DTMF) telephone.

Remote access

You can ring your phone from another tone-dialing phone to switch on or off the answering machine and listen to your messages remotely. Dial your own telephone number. If the answering machine is set to off, it will answer after 10 rings. If the answering machine is set to on it will answer after the preset delay. Press the star key  while hearing the message and enter the remote PIN. If you entered the PIN correctly you will have the following options:









The connection will be cut off if a wrong remote PIN is entered three times.

	to start/stop playback.
	to begin the relevant message again or to go back to the previous message (press key 4 twice).
	to skip to the next message.
	to delete the relevant message.
	to stop playback.
	to switch on the answering machine.
	to switch off the answering machine.







11 Registering/de-registering handsets

Five handsets can be registered to a base station. The handsets delivered with your telephone are already registered. To register a "foreign" handset please refer to it's user manual.

Registering a handset of the same type

Menu	Press the Menu softkey.
 / 	Select Registration and press Select .
 / 	Select a base station and press Select . Base stations to which the handset is already registered are shown in outlined characters. The relevant base is marked with a *.
	Enter the relevant PIN for the base, the new handset should be registered on, and press OK .
	Press and hold down the paging key on the base station until a short beep is to be heard (approx. 5 sec). After a few seconds the antenna icon on the display is on. The handset is registered.

Deleting a handset

Menu	Press the Menu softkey.
 / 	Select Base Settings and press Select .
 / 	Select Delete HS and press Select .
	Enter the relevant PIN (default 0 0 0 0) and press OK .
 / 	Select a handset and press Select .

 You cannot de-register the handset you are currently using.

12 PBX / Supplementary Services

PBX

If the telephone is connected to a private branch exchange, functions such as transferring calls and automatic call back can be used via the R button. Refer to the operating manual provided with your private branch exchange as to which Flash time must be set in order to use these functions. The sales outlet where you purchased the exchange can provide information as to whether the telephone will work properly with the exchange.

Please remember to enter the access code and a necessary dialling pause (a long press "0") when creating phone book entries.

Supplementary services

Your telephone supports supplementary services provided by your telephone network provider, such as brokering, call waiting and conference facilities. These supplementary services can be used via the R-button. Please contact your telephone network provider regarding which Flash time must be set to use the supplementary services. Contact your telephone network provider with regard to enabling supplementary services.

13 Menu Structure

Call List	Add to PB Delete Delete All	
Phonebook	View Add Edit Delete Delete All PB Status	
Clock/Alarm	Date & Time	Date Format Time Format Set Date Set Time
HS Settings	Alarm Audio Setup Ring Setup Tone Setup Language Rename HS Contrast Auto Answer Select Base HS Default	Alarm On / Alarm Off / Alarm Melody Speaker Volume Ear Volume Internal Ring External Ring Ring Volume Key Tone On / Off Battery Low On / Off Out of Range On / Off Deutsch / English / Française / Italiano Level 1-5 On / Off

Base Settings	Delete HS Ring Setup	Ring Melody Ring Volume Tone / Pulse Short / Medium / Long
	Dial Mode Flash Time Modify PIN BS Default	
Registration		
Answer Machine	Playback Delete All Memo TAM On/Off TAM Settings	Answer Mode TAM Language OGM Settings Answer Delay Recording Time Base Screening Remote Access Chg Remote PIN

14 In Case of Problems

Should problems arise with the telephone, please refer to the following information first. In the case of technical problems, you can contact our hotline service, Tel. 0900 00 1675 within Switzerland (Costs for call from Swisscom landline at time of going to print: CHF 2.60/min). In the case of claims under the terms of guarantee, contact your sales outlet. There is a 2 year period of guarantee.

- After pressing the on hook button, no ring tone is audible, the line is not engaged.
 - Check the telephone connector on the base station and on the wall socket.
 - Check power connector on the base station and on 230 V.
 - The line is being occupied by another handset. Wait until the connection is terminated.
- Display: **Searching**
 - Check power connector on the base station and on 230 V.
 - Reduce range.
 - Register handset.
- No display.
 - Handset turned off -> turn on.
 - Battery empty -> recharge.

Default settings

Call list:	No entry
Phonebook:	No entry
Alarm:	Off
Ringer handset:	Internal call: Melody 2 External call: Melody 1 Volume: 3
Ringer base:	Melody 1 Volume: 3
Tone setup:	Key tone: On Battery tone: On Out of range: On
Language:	German
Handset name:	DFT 1471
Auto answer:	On
Date & Time:	Date format: DD-MM-YYYY Time format: 24 hours
Dial mode:	Tone

Flash time:	Short (100 ms)
PIN:	0 0 0 0
Answering machine:	On
TAM language:	German
Answer delay:	6 rings
Answer mode:	Answer and record
Record time:	120 s
Fernabfrage:	On
Screening:	On
Remote PIN:	0 0 0 0

15 Technical data

Standard:	DECT / GAP
Transmitter power:	10 mW (average power per channel)
Range:	up to 300 m outside, up to 50 m inside buildings
Electricity supply base station:	100~240 V _{AC} / 50/60 Hz / 150 mA, 6 V _{DC} / 450 mA
Electricity supply charger:	100~240 V _{AC} / 50/60 Hz / 150 mA, 6 V _{DC} / 300 mA
Power supply, handset:	NiMH battery pack / 2.4 V / 500 mAh
Handset: Operating time:	Stand-by time / Talk time 500 mAh = up to 100 h / up to 10 h
Charging time:	approx. 15 hours
Operating temperature for handset operation:	5°C to 40°C ; 20 % to 75 % rel. humidity
Operating temperature for base station operation:	5°C to 40°C ; 20 % to 75 % rel. humidity
Storage temperature:	-10°C to +60°C
Dial mode:	Tone / Pulse R-key: Flash time (100 ms / 300 ms / 600 ms)

Declaration of Conformity

This device fulfils the requirements stipulated in the EU directives:

- 1999/5/EU directive on radio equipment and telecommunications terminal equipment and the mutual recognition of their conformity.



- 2005/32/EU directive "Energy-using products".
- Regulation 1275/2008 "Electric power consumption in standby- and offstate".
- Regulation 278/2009 "External power supplies without load and their average efficiency in use".

Conformity with the above mentioned directives is confirmed by the CE symbol on the device.

To view the complete Declaration of Conformity, please refer to the free download available on our web site www.switel.com.

Maintenance

- Clean the housing surfaces with a soft, fluff-free cloth.
- Do not use any cleaning agents or solvents.

16 Guarantee

SWITEL - equipment is produced and tested according to the latest production methods. The implementation of carefully chosen materials and highly developed technologies ensure trouble-free functioning and a long service life. The terms of guarantee do not apply where the cause of equipment malfunction is the fault of the telephone network operator or any interposed private branch extension system. The terms of guarantee do not apply to the batteries or power packs used in the products. The period of guarantee is 24 months from the date of purchase.

All deficiencies related to material or manufacturing errors within the period of guarantee will be redressed free of charge. Rights to claims under the terms of guarantee are annulled following tampering by the purchaser or third parties. Damage caused as the result of improper handling or operation, normal wear and tear, incorrect positioning or storage, improper connection or installation or Acts of God and other external influences are excluded from the terms of guarantee. In the case of complaints, we reserve the right to repair defect parts, replace them or replace the entire device. Replaced parts or devices become our property. Rights to compensation in the case of damage are excluded where there is no evidence of intent or gross negligence by the manufacturer.

If your device shows signs of defect during the period of guarantee, please return it to the sales outlet in which you purchased the SWITEL device together with the purchase receipt. All claims under the terms of guarantee in accordance with this agreement can only be asserted at the sales outlet. No claims under the terms of guarantee can be asserted after a period of two years from the date of purchase and hand-over of the product.

SWITEL



Declaration of Conformity

Diese Anlage entspricht der europäischen R&TTE Richtlinie.
Für die komplette Konformitätserklärung nutzen Sie bitte den kostenlosen Download von unserer Website www.switel.com.

Cet équipement est conforme à la directive européenne R&TTE.
Pour obtenir la déclaration de conformité intégrale, veuillez vous servir du téléchargement gratuit de notre site Internet www.switel.com.

Quest'apparecchiatura è conforme alla direttiva europea R&TTE.
Per la dichiarazione di conformità completa si prega di voler usufruire del servizio gratuito di download dal nostro sito Internet www.switel.com.

This equipment complies with the European R&TTE directive.
To view the complete Declaration of Conformity, please refer to the free download available at our web site: www.switel.com.

Service Hotline

Bei technischen Problemen können Sie sich an unsere Service-Hotline unter Tel. 0900 00 1675 innerhalb der Schweiz (Kosten Swisscom bei Drucklegung: CHF 2.60/min) wenden.

S'il s'agit de problèmes techniques, vous pouvez vous adresser à notre hotline de service en Suisse en appelant le numéro 0900 00 1675 (frais Swisscom à la date d'impression de ce manuel : CHF 2.60/min).

In caso di problemi tecnici è possibile rivolgersi alla nostra hotline di assistenza tecnica chiamando al numero 0900 00 1675 valido per la Svizzera (spese da rete Swisscom alla data di stampa: CHF 2.60 / min).

In the event of technical problems, you can contact our hotline service, Tel. 0900 00 1675 within Switzerland (cost via Swisscom at time of going to print: CHF 2.60/min).