

SWITEL

SWISS BRAND 

WTF 719



Bedienungsanleitung
Mode d'emploi
Istruzioni per l'uso
Operating Instructions

D

F

I

GB

SWITEL

Bedienungsanleitung	3
Mode d'emploi	21
Istruzioni per l'uso	39
Operating Instructions	59
Declaration of Conformity	78

Inhaltsverzeichnis

1	Sicherheitshinweise	4
2	Funkgeräte in Betrieb nehmen	6
3	Bedienelemente	9
4	Wie bediene ich meine Funkgeräte?	10
5	Falls es Probleme gibt	17
6	Technische Eigenschaften	18
7	Pflegehinweise / Garantie	19
8	Stichwortverzeichnis	20

Sicherheitshinweise

1 Sicherheitshinweise

Lesen Sie diese Bedienungsanleitung sorgfältig durch.

Bestimmungsgemäße Verwendung

Diese Sprechfunkgeräte sind geeignet für die Kommunikation mit anderen Sprechfunkgeräten gleichen Standards. Jede andere Verwendung gilt als nicht bestimmungsgemäß. Eigenmächtige Veränderungen oder Umbauten sind nicht zulässig. Öffnen Sie die Geräte in keinem Fall selbst und führen Sie keine eigenen Reparaturversuche durch.

Verwendungsbereich

Vermeiden Sie Belastungen durch Rauch, Staub, Erschütterungen, Chemikalien, Feuchtigkeit, Hitze oder direkte Sonneneinstrahlung. Verwenden Sie die Funkgeräte nicht in explosionsgefährdeten Bereichen.

Netzteil



Achtung: Verwenden Sie nur das mitgelieferte Steckernetzteil, da andere Netzteile die Funkgeräte zerstören können. Sie dürfen den Zugang zum Steckernetzteil nicht durch Möbel oder andere Gegenstände versperren.

Aufladbare Akkus



Achtung: Werfen Sie Akkus nicht ins Feuer. Verwenden Sie nur Akkus des gleichen Typs! Achten Sie auf die richtige Polung! Bei verkehrter Polung der Akkus besteht beim Aufladen Explosionsgefahr.

Medizinische Geräte



Achtung: Benutzen Sie die Funkgeräte nicht in der Nähe von medizinischen Geräten. Eine Beeinflussung kann nicht völlig ausgeschlossen werden. Funkgeräte können in Hörgeräten einen unangenehmen Brummtönen verursachen.

Entsorgung

Wollen Sie Ihr Gerät entsorgen, bringen Sie es zur Sammelstelle Ihres kommunalen Entsorgungsträgers (z. B. Wertstoffhof). Nach dem Elektro- und Elektronikgerätegesetz sind Besitzer von Altgeräten gesetzlich verpflichtet, alte **Elektro- und Elektronikgeräte** einer getrennten Abfallerfassung zuzuführen. Das nebenstehende Symbol bedeutet, dass Sie das Gerät auf keinen Fall in den Hausmüll werfen dürfen!



Gefährdung von Gesundheit und Umwelt durch Akkus und Batterien!



Akkus und Batterien nie öffnen, beschädigen, verschlucken oder in die Umwelt gelangen lassen. Sie können giftige und umweltschädliche Schwermetalle enthalten. Sie sind gesetzlich verpflichtet, Akkus und Batterien beim batterievertreibenden Handel sowie bei zuständigen Sammelstellen, die entsprechende Behälter bereitstellen, sicher zu entsorgen. Die Entsorgung ist unentgeltlich. Die Symbole bedeuten, dass Sie Akkus und Batterien auf keinen Fall in den Hausmüll werfen dürfen und sie über Sammelstellen der Entsorgung zugeführt werden müssen.

Verpackungsmaterialien entsorgen Sie entsprechend den lokalen Vorschriften.

Funkgeräte in Betrieb nehmen

2 Funkgeräte in Betrieb nehmen

Sicherheitshinweise



Achtung: Lesen Sie vor der Inbetriebnahme unbedingt die Sicherheitshinweise in Kapitel 1.

Verpackungsinhalt prüfen

Zum Lieferumfang gehören:

- zwei Funkgeräte mit Gürtelclip
- zwei Akkupacks
- eine Bedienungsanleitung
- ein Netzteil (Ladekabel)

Funkgerät direkt anschließen

Schließen Sie Ihr Funkgerät wie auf der Skizze abgebildet an. Verwenden Sie aus Sicherheitsgründen nur das mitgelieferte Netzteil.

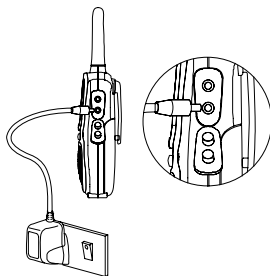

Funkgeräte in Betrieb nehmen

Akkupack einlegen

Öffnen Sie das Akkufach. Legen Sie den mitgelieferten Akkupack ein. Achten Sie auf die richtige Polung! Schließen Sie das Akkufach.



Achtung: Standard Akkus und Batterien werden in der Ladestation nicht geladen. Verwenden Sie nur den mitgelieferten Akkupack oder Akkupacks der gleichen Bauweise.

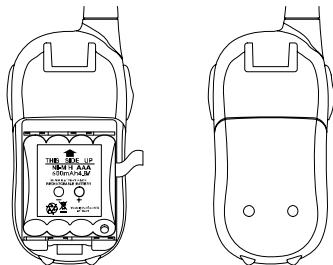

Akkupack aufladen

Laden Sie die Funkgeräte vor der ersten Inbetriebnahme für mindestens 14 Stunden



Laden Sie die Akkupacks nicht mit fremden Aufladegeräten.

Die Akkukapazität wird im Display durch das -Symbol angezeigt.

voll



halb



schwach



leer



Sobald die Anzeige im Display blinkt und Warntöne zu hören sind, muss der Akkupack aufgeladen werden.

D

Funkgeräte in Betrieb nehmen

Energiesparmodus

Ihr Funkgerät ist mit einem Energiesparmodus ausgestattet, um die Lebensdauer Ihrer Akkupacks zu verlängern. Wenn Sie 4 Sekunden lang keine Taste am Funkgerät drücken, wird der Energiesparmodus eingeschaltet. Sobald Sie eine Taste drücken oder ein Signal empfangen, wird der Energiesparmodus ausgeschaltet.

Gürtelclip anbringen

Schieben Sie den Gürtelclip von oben in die Führung, bis er hörbar einrastet. Um den Gürtelclip wieder zu entfernen, heben Sie die Befestigungsglasche mit dem Fingernagel etwas an und schieben den Gürtelclip nach oben.

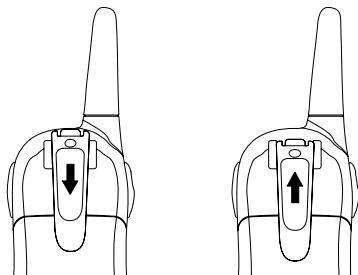

3 Bedienelemente

Die Tasten Ihres Funkgeräts werden in dieser Bedienungsanleitung nachfolgend mit vereinheitlichten Symbolen dargestellt. Leichte Abweichungen der Tastensymbole Ihres Funkgeräts gegenüber den hier verwendeten Tastensymbolen sind daher möglich.

Funkgerät

- 1 Display
- 2 Headsetanschluss
- 3 Ladekabelanschluss
- 4 Ein / Aus
- 5 Menü
- 6 Mikrofon
- 7 Lautstärke / Einstellung +
- 8 Lautsprecher
- 9 Lautstärke / Einstellung -
- 10 Rufton senden
- 11 PTT-Sprechtaste
- 12 Antenne

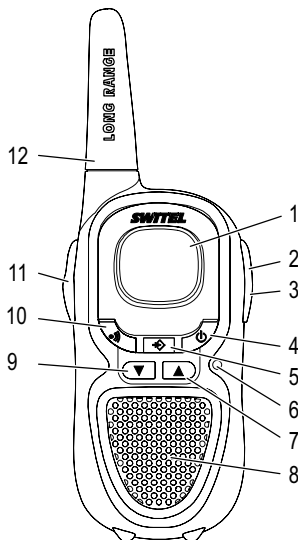

Display

- 1 Kanalsuche
- 2 Senden
- 3 DCS¹ aktiv
- 4 CTCSS² aktiv
- 5 CTCSS-/DCS-Code
- 6 Lautstärke
- 7 VOX³-Mode
- 8 Signalisierung
- 9 Zweikanalüberwachung
- 10 Tastensperre
- 11 Akkukapazität
- 12 Kanal
- 13 Empfangen

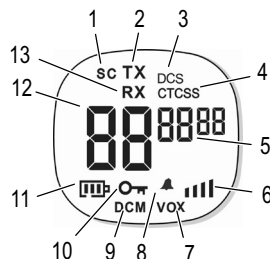

¹ **DCS: Digital Coded Squelch** = Selektivruf

² **CTCSS: Continous Tone Coded Squelch System** = Selektivruf

³ **VOX: Voice Operated Transmission** = Geräuscherkennung





Wie bediene ich meine Funkgeräte?

4 Wie bediene ich meine Funkgeräte?



Darstellungen und Schreibweisen

	Abgebildete Taste drücken
2 sec 	Abgebildete Taste 2 Sekunden drücken
2 x 	Abgebildete Taste 2-mal drücken
 PTT	Abgebildete Taste gedrückt halten
 PTT	Abgebildete Taste loslassen
	Displayanzeige
	In das Mikrofon sprechen



Ein- / Ausschalten der Funkgeräte

 	Funkgerät einschalten
	Es erklingt ein Signal. Im Display wird der aktuell eingestellte Kanal angezeigt.
 	Funkgerät ausschalten

Lautstärkeregelung

 oder 	Lauter oder leiser
--	--------------------

Displaybeleuchtung

Nach dem Betätigen einer Taste, außer der -Taste und -Taste, wird das Display für 4 Sekunden beleuchtet.

Wie bediene ich meine Funkgeräte?

Senden und Empfangen

Senden



Senden



Halten Sie das Funkgerät ca. 5 bis 7 cm vom Mund entfernt und sprechen Sie mit normaler Lautstärke. Um mit anderen Teilnehmern zu sprechen, müssen alle Funkgeräte auf den gleichen Kanal und die gleiche Rufcodierung eingestellt sein.

Empfangen



Empfangen



Sie können keine Funksignale empfangen, wenn Sie die **PTT**-Taste gedrückt halten.

Bestätigungston (Roger Beep)

Der Bestätigungston erklingt, wenn Sie die **PTT**-Taste loslassen. Dadurch wird Ihrem Gesprächspartner signalisiert, dass Ihre Übertragung beendet ist.

Bestätigungston ein-/ausschalten



Einstellungsmodus aktivieren



Bestätigungston einschalten



Bestätigungston ausschalten

Kanalwahl



Einstellungsmodus aktivieren

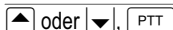

Kanal auswählen und bestätigen

Kanal	Frequenz (MHz)	Kanal	Frequenz (MHz)
1	446.00625	5	446.05625
2	446.01875	6	446.06875
3	446.03125	7	446.08125
4	446.04375	8	446.09375

Wie bediene ich meine Funkgeräte?

CTCSS¹-/DCS²-Code (Rufcodierung) wählen

Es stehen 38 analoge (CTCSS 1 - 38) und 83 digitale (DCS 1 - 83) Codierungen je Kanal zur Verfügung. Funkteilnehmer können nur miteinander kommunizieren, wenn Funkkanal und Rufcodierung an den Geräten übereinstimmen.



Die Rufcodierung wird als nicht hörbares Signal mit der normalen Sprachnachricht mitgesendet. Bei dem Empfänger wird die Sprache nur dann auf den Lautsprecher übertragen, wenn der eingestellte Kanal und die Rufcodierung mit den empfangenen Daten (Einstellungen vom Sender) identisch sind. Sollte zufälligerweise auf demselben Kanal ein anderer Teilnehmer dieselbe Rufcodierung verwenden, wechseln Sie bitte mit Ihrem Gesprächspartner auf einen freien Kanal.

2 x

Einstellungsmodus aktivieren

oder ,

CTCSS-Code auswählen und bestätigen

oder

3 x

Einstellungsmodus aktivieren

oder ,

DCS-Code auswählen und bestätigen



Eine Ausnahme ist die Rufcodierung 0 (Null). Bei dieser Einstellung können alle Gespräche auf dem eingestellten Kanal gehört werden. Um am Funkverkehr teilnehmen zu können, müssen Sie dann die entsprechende Rufcodierung einstellen.



¹ **CTCSS**: Continous Tone Coded Squelch System = Selektivruf

² **DCS**: Digital Coded Squelch = Selektivruf

Wie bediene ich meine Funkgeräte?

Kanalsuche

In einer Endlosschleife wird auf allen acht Kanälen und den Rufcodierungen nach Signalen gesucht. Im Display erscheint **SC**. Wird Funkverkehr gefunden, stoppt die Kanalsuche.

- Drücken Sie die Taste , um auf diesem Kanal am Funkverkehr teilzunehmen. Das Funkgerät wird auf den Kanal eingestellt und die Kanalsuche wird beendet.
- Drücken Sie die Taste , nicht, wird die Kanalsuche nach fünf Sekunden, nachdem kein Signal mehr auf diesem Kanal gesendet wurde, fortgesetzt.

Kanalsuche starten

5 x  Einstellungsmodus aktivieren

 Kanalsuche starten

Der Suchlauf stoppt bei jedem Kanal, auf dem ein Signal empfangen wird, unabhängig davon, mit welcher Rufcodierung dieses Signal gesendet wird.

Kanalsuche fortsetzen

 Kanalsuche fortsetzen

CTCSS-Codes durchsuchen

6 x  Einstellungsmodus aktivieren

 CTCSS-Codes durchsuchen

Der Suchlauf stoppt, wenn auf dem eingestellten Kanal ein Signal mit einer CTCSS-Rufcodierung gesendet wird.

DCS-Codes durchsuchen

7 x  Einstellungsmodus aktivieren

 DCS-Codes durchsuchen

Der Suchlauf stoppt, wenn auf dem eingestellten Kanal ein Signal mit einer DCS-Rufcodierung gesendet wird.

Kanalsuche beenden











 Kanalsuche beenden

Wie bediene ich meine Funkgeräte?

Zweikanalüberwachung

Bei aktivierter Zweikanalüberwachung wechselt das Funkgerät automatisch zwischen zwei Kanälen, bis ein Funksignal gefunden wird. So können Sie mit zwei Gesprächspartnern auf getrennten Kanälen sprechen.





Zweikanalüberwachung starten

12 x 	Einstellungsmodus aktivieren
 oder  , 	Zusätzlichen Kanal auswählen und bestätigen
 oder  , 	CTCSS-Code ändern und bestätigen
 oder  , 	DCS-Code ändern und bestätigen



Bei der Zweikanalüberwachung werden der aktuell eingestellte und der zusätzliche Kanal abwechselnd im Display angezeigt.

Zweikanalüberwachung beenden





12 x 	Einstellungsmodus aktivieren
 oder   , 	Zweikanalüberwachung beenden

Rufton senden

Der Rufton macht andere Teilnehmer darauf aufmerksam, dass Sie ein Gespräch beginnen möchten. Voraussetzung dafür ist, dass die anderen Teilnehmer den gleichen Kanal und die gleiche Rufcodierung verwenden.

 	Rufton senden
---	---------------

Rufton wählen

8 x 	Einstellungsmodus aktivieren
 oder  , 	Rufton auswählen und bestätigen

Wie bediene ich meine Funkgeräte?

Monitor-Funktion

Die Monitor-Funktion ermöglicht es Ihnen, auf dem aktuell eingestellten Kanal nach schwachen Signalen zu suchen. Wenn Sie ein fremdes Signal empfangen, wechseln Sie auf einen freien Kanal. Kommunizieren Sie mit anderen Teilnehmern immer auf einem freien Kanal, um Störungen zu vermeiden.

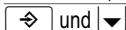

Kanal abhören



Abhören beenden

Tastensperre

Die Tastensperre verhindert das ungewollte Ändern von Einstellungen. Bei eingeschalteter Tastensperre erscheint das -Symbol im Display.

Aktivieren



Tastensperre aktivieren

Deaktivieren



Tastensperre deaktivieren

Tastenton

Bei jedem Tastendruck ertönt ein Bestätigungston. Sie können diesen Tastenton aus- und einschalten.



Einstellungsmodus aktivieren



Tastenton einschalten



Tastenton ausschalten

Stoppuhr

Sie können Ihre Funkgeräte als Stoppuhr nutzen.

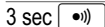

Stoppuhr aktivieren



Start / Stopp / Weiter



Zurücksetzen

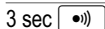

Stoppuhr deaktivieren

Wie bediene ich meine Funkgeräte?

VOX¹-Modus (Freisprechen)

Bei dieser Funktion beginnt das Funkgerät automatisch zu senden, wenn eine Stimme oder ein Geräusch erkannt wird.



Wenn Sie anfangen zu sprechen, tritt eine kurze Verzögerung auf, bevor das Funkgerät sendet.

VOX-Empfindlichkeit

Für den Betrieb im VOX-Modus können 3 Empfindlichkeitsstufen entsprechend der **Umgebungsgeräusche** gewählt werden.

Stufe 1	Stufe 2	Stufe 3
laute Umgebungsgeräusche	normale Umgebungsgeräusche	leise Umgebungsgeräusche

VOX-Modus aktivieren

Beim Freisprechen im **VOX**-Modus muss die **PTT** -Taste am Funkgerät nicht gedrückt werden, um zu senden.



Einstellungsmodus aktivieren



VOX-Empfindlichkeit wählen und bestätigen

VOX-Modus deaktivieren



Einstellungsmodus aktivieren



VOX-Modus deaktivieren

Headset

Schließen Sie das Headset an der rechten Seite des Funkgeräts an. Aktivieren Sie den VOX-Modus. Klemmen Sie das Funkgerät an den Gürtel und befestigen das Kabel des Headsets an Ihrer Kleidung, sodass sich das Mikrofon kurz vor Ihrem Mund befindet. Jetzt können Sie freihändig empfangen und senden.

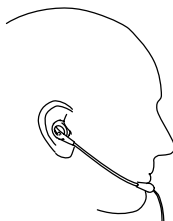

¹ **VOX**: Voice Operated Transmission = Geräuscherkennung

5 Falls es Probleme gibt

Service-Hotline

Haben Sie Probleme mit Ihrem Funkgerät, kontrollieren Sie zuerst die folgenden Hinweise. Bei technischen Problemen können Sie sich an unsere Service-Hotline unter Tel. 0900 00 1675 innerhalb der Schweiz (Kosten Swisscom bei Drucklegung: CHF 2.60/min) wenden. Bei Garantieansprüchen wenden Sie sich an Ihren Fachhändler. Die Garantiezeit beträgt 2 Jahre.

Fragen und Antworten

Fragen	Antworten
Keine Funktion	<ul style="list-style-type: none">- Der Akkupack ist nicht korrekt eingelegt- Der Akkupack ist nicht geladen- Der Akkupack ist defekt
Senden nicht möglich	<ul style="list-style-type: none">- Drücken Sie die <input type="checkbox"/> PTT -Taste vollständig, um zu senden- Ihr Kanal wird von anderen Teilnehmern benutzt
Kein Empfang	<ul style="list-style-type: none">- Lassen Sie die <input type="checkbox"/> PTT -Taste los, um zu empfangen- Die Lautstärke ist zu gering eingestellt- Sie befinden sich außerhalb des Empfangsbereichs, ändern Sie Ihre Position- Hindernisse wie Bäume und Gebäude haben einen negativen Einfluss auf die Reichweite- Nutzen Sie die Funktion "Monitor", um nach schwachen Signalen zu suchen
Keine Kommunikation möglich	<ul style="list-style-type: none">- Um mit anderen Teilnehmern zu sprechen, müssen alle Funkgeräte auf den gleichen Kanal und die gleiche Rufcodierung eingestellt sein.

Technische Eigenschaften

6 Technische Eigenschaften

Technische Daten

Merkmal	Wert
Ausgangsleistung	0.5 W
Reichweite	ca. 8 km - bei freier Sichtlinie
Akkupack	NiMh 4.8V, 600mAh

Reichweite

Hindernisse wie Bäume und Gebäude haben einen negativen Einfluss auf die Reichweite. Die folgende Skizze zeigt die zu erwartende Reichweite bei unterschiedlichen Bedingungen.

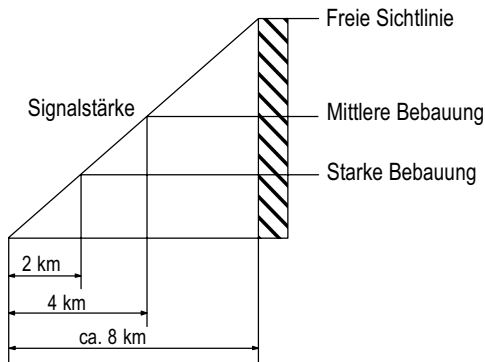

Konformitätserklärung

Dieses Gerät erfüllt die Anforderungen der EU-Richtlinie: 1999/5/EG Richtlinie über Funkanlagen und Telekommunikationsendeinrichtungen und die gegenseitige Anerkennung ihrer Konformität. Die Konformität mit der o. a. Richtlinie wird durch das CE-Zeichen auf dem Gerät bestätigt.



7 Pflegehinweise / Garantie

Pflegehinweise

- Reinigen Sie die Gehäuseoberflächen mit einem weichen und fusselfreien Tuch.
- Verwenden Sie keine Reinigungsmittel oder Lösungsmittel.

Garantie

SWITEL - Geräte werden nach den modernsten Produktionsverfahren hergestellt und geprüft. Ausgesuchte Materialien und hoch entwickelte Technologien sorgen für einwandfreie Funktion und lange Lebensdauer. Die Garantie gilt nicht für die in den Produkten verwendeten Batterien, Akkus oder Akkupacks. Die Garantiezeit beträgt 24 Monate, gerechnet vom Tage des Kaufs.

Innerhalb der Garantiezeit werden alle Mängel, die auf Material- oder Herstellungsfehler zurückzuführen sind, kostenlos beseitigt. Der Garantieanspruch erlischt bei Eingriffen durch den Käufer oder durch Dritte. Schäden, die durch unsachgemäße Behandlung oder Bedienung, natürliche Abnutzung, durch falsches Aufstellen oder Aufbewahren, durch unsachgemäßen Anschluss oder Installation sowie durch höhere Gewalt oder sonstige äußere Einflüsse entstehen, fallen nicht unter die Garantieleistung. Wir behalten uns vor, bei Reklamationen die defekten Teile auszubessern, zu ersetzen oder das Gerät auszutauschen. Ausgetauschte Teile oder ausgetauschte Geräte gehen in unser Eigentum über. Schadenersatzansprüche sind ausgeschlossen, soweit sie nicht auf Vorsatz oder grober Fahrlässigkeit des Herstellers beruhen.

Sollte Ihr Gerät dennoch einen Defekt innerhalb der Garantiezeit aufweisen, wenden Sie sich bitte unter Vorlage Ihrer Kaufquittung ausschließlich an das Geschäft, in dem Sie Ihr SWITEL - Gerät gekauft haben. Alle Gewährleistungsansprüche nach diesen Bestimmungen sind ausschließlich gegenüber Ihrem Fachhändler geltend zu machen. Nach Ablauf von zwei Jahren nach Kauf und Übergabe unserer Produkte können Gewährleistungsrechte nicht mehr geltend gemacht werden.

Stichwortverzeichnis

8 Stichwortverzeichnis

A

Akkupack aufladen, 7
Akkupack einlegen, 7
Ausschalten, 10

B

Bedienelemente, 9
Bedienung, 10
Bestätigungston, 11

C

CTCSS-/DCS-Code, 12

D

Display, 9
Displaybeleuchtung, 10

E

Einschalten, 10
Empfangen, 11
Energiesparmodus, 8

F

Fehlerbehebung, 17
Fragen und Antworten, 17
Freisprechen, 16
Funkgeräte in Betrieb nehmen, 6

G

Garantie, 19
Gürtelclip anbringen, 8

H

Headset, 16

K

Kanalsuche, 13
Kanalwahl, 11
Konformitätserklärung, 18

L

Lautstärkeregelung, 10

M

Monitor-Funktion, 15

P

Pflegehinweise, 19
Probleme, 17

R

Reichweite, 18
Roger Beep, 11
Rufton, 14

S

Schreibweisen, 10
Senden, 11
Service Hotline, 17
Sicherheitshinweise, 4
Stoppuhr, 15

T

Tastensperre, 15
Tastenton, 15
Technische Daten, 18

U

Umgebungsgeräusche, 16

V

Verpackungsinhalt, 6
VOX-Empfindlichkeit, 16
VOX-Modus, 16

Z

Zweikanalüberwachung, 14

Table des matières

1	Consignes de sécurité	22
2	Mise en service de l'émetteur-récepteur	24
3	Éléments de manipulation	27
4	Comment utiliser l'émetteur-récepteur ?	28
5	En cas de problèmes	35
6	Caractéristiques techniques	36
7	Remarques d'entretien / Garantie . . .	37
8	Index	38

Consignes de sécurité

1 Consignes de sécurité

Lisez très attentivement ce mode d'emploi.

Utilisation conforme aux prescriptions

Ces émetteurs-récepteurs conviennent à la communication avec d'autres émetteurs-récepteurs de même standard. Toute autre utilisation est considérée comme non conforme à l'usage. Des modifications ou changements effectués d'un propre gré ne sont pas autorisés. N'ouvrez en aucun cas les appareils et n'effectuez aucun essai de réparation vous-même.

Lieu d'utilisation

Évitez toute nuisance par la fumée, la poussière, les vibrations, les produits chimiques, l'humidité, la grande chaleur ou l'ensoleillement direct.

Ne vous servez pas des émetteurs-récepteurs dans des endroits exposés aux explosions.

Bloc secteur



Attention : N'utilisez que le bloc d'alimentation enfichable fourni avec les émetteurs-récepteurs, d'autres blocs pouvant les détruire. Vous ne devez pas bloquer son accès par des meubles ou autres objets.

Piles rechargeables



Attention : Ne jetez pas les piles rechargeables dans le feu. N'utilisez que des piles du même type ! Observez une polarisation correcte ! Risque d'explosion pendant leur charge si la polarisation est incorrecte.

Appareils médicaux



Attention : N'utilisez pas les émetteurs-récepteurs à proximité d'appareils médicaux. Leur influence sur ces appareils ne peut pas être entièrement exclue. Les émetteurs-récepteurs peuvent causer un bourdonnement désagréable dans les prothèses auditives.

Élimination

Si vous ne voulez plus vous servir de vos appareils, veuillez les apporter au centre de collecte de l'organisme d'élimination des déchets de votre commune (par ex. centre de recyclage). D'après la loi relative aux appareils électriques et électroniques, les propriétaires d'appareils usagés sont tenus de mettre tous les **appareils électriques et électroniques** usagés dans un collecteur séparé. L'icône ci-contre signifie que vous ne devez en aucun cas jeter vos appareils dans les ordures ménagères !



Mise en danger de l'homme et l'environnement causée par les piles et les piles rechargeables !



Ne jamais ouvrir, endommager, avaler les piles rechargeables et les piles ou ne jamais faire pénétrer leur contenu dans l'environnement. Elles peuvent contenir des métaux lourds toxiques et nuisibles pour celui-ci. Vous êtes tenus par la loi d'éliminer vos piles rechargeables et piles auprès d'un revendeur de piles ainsi qu'auprès de centres de collecte responsables de leur élimination qui mettent des conteneurs adéquats à disposition. L'élimination des piles est gratuite. L'icône ci-contre signifie que vous ne devez en aucun cas jeter les piles rechargeables et piles dans les ordures ménagères, mais que vous devez les éliminer auprès de centres de collecte.

Éliminez **les matériaux d'emballage** conformément au règlement local.

Mise en service de l'émetteur-récepteur

2 Mise en service de l'émetteur-récepteur

Remarques concernant la sécurité



Attention : Avant de mettre votre appareil en service, lisez impérativement les consignes de sécurité mentionnées au chapitre 1.

Vérifier le contenu du coffret

Contenu du coffret :

- deux émetteur-récepteur avec clip de ceinture
- un mode d'emploi
- deux packs de piles rechargeables
- un bloc secteur (câble chargeur)

Raccorder directement l'émetteur-récepteur

Raccordez votre émetteur-récepteur tel que représenté sur le croquis. Pour des raisons de sécurité, n'utilisez que le bloc secteur fourni avec l'appareil.

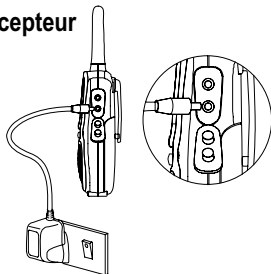

Mise en service de l'émetteur-récepteur

Mettre en place le pack de piles rechargeables

Ouvrez le compartiment à piles. Insérez le pack. Observez une polarisation correcte ! Fermez le compartiment à piles.



Attention : Ne pas charger des piles rechargeables et batteries dans la station d'accueil. N'utilisez que le pack fourni avec l'appareil ou des packs du même type.

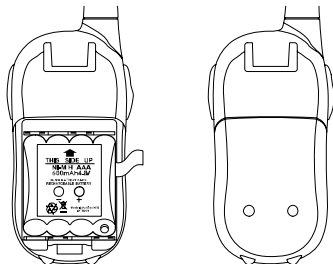

Charge du pack de piles rechargeables

Avant la première mise en service, chargez les émetteurs-récepteurs pendant un minimum de 14 heures.



Ne chargez pas les packs avec des chargeurs d'un autre fabricant.

La capacité de charge des piles est indiquée sur l'écran  par le symbole - :

Plein



Moyen



Faible



Vide



Dès que l'affichage clignote à l'écran et que des signaux sonores d'avertissement se font entendre, le pack de piles rechargeables doit être rechargé.

Mise en service de l'émetteur-récepteur

Mode économie d'énergie

Votre émetteur-récepteur est doté d'un mode économie d'énergie afin de prolonger la durée de vie du pack de piles rechargeables. Si vous n'actionnez aucune touche de l'émetteur-récepteur pendant 4 secondes, le mode économie d'énergie s'active. Dès que vous appuyez sur une touche ou que vous recevez un signal, le mode économie d'énergie se désactive.

Fixer le clip de ceinture

Introduisez le clip de ceinture par le haut dans le guidage jusqu'à ce qu'il s'enclenche. Pour l'enlever, soulevez légèrement la languette de fixation avec l'ongle et poussez le clip vers le haut.

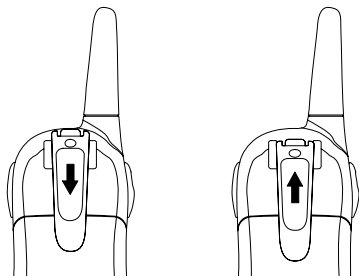

3 Eléments de manipulation

Dans ce mode d'emploi, les touches de votre émetteur-récepteur seront représentées par la suite par des icônes standardisées. De ce fait, il peut y avoir de légères différences entre les icônes des touches de votre émetteur-récepteur et celles utilisées ici.

Émetteur-récepteur

- 1 Écran
- 2 Prise du kit oreillettes
- 3 Prise du câble chargeur
- 4 Allumé / Éteint
- 5 Menu
- 6 Microphone
- 7 Volume sonore / réglage +
- 8 Haut-parleur
- 9 Volume sonore / réglage -
- 10 Émission d'un signal d'appel
- 11 Touche de conversation PTT
- 12 Antenne

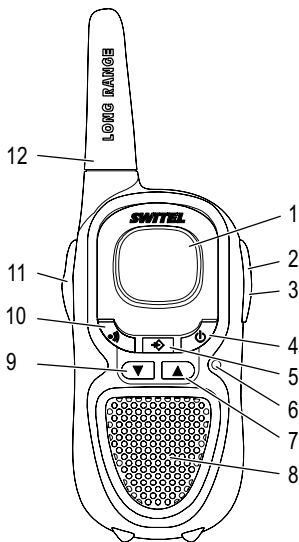

Écran

- 1 Recherche du canal
- 2 Émission
- 3 DCS¹ actif
- 4 CTCSS² actif
- 5 Code CTCSS / DCS
- 6 Volume sonore
- 7 Mode VOX³
- 8 Signalisation
- 9 Surveillance de deux canaux
- 10 Verrouillage des touches
- 11 Capacité des piles
- 12 Canal
- 13 Réception



¹ **DCS** : Digital Coded Squelch







² **CTCSS** : Continous Tone Coded Squelch System

³ **VOX** : Voice Operated Transmission = Détection de bruits

Comment utiliser l'émetteur-récepteur ?

4 Comment utiliser l'émetteur-récepteur ?

Représentations et notations

	Appuyer sur la touche représentée
2 sec 	Appuyer 2 secondes sur la touche représentée
2 x 	Appuyer 2 fois sur la touche représentée
 PTT	Appuyer longuement sur la touche représentée
 PTT	Relâcher la touche représentée
ON	Affichage de l'écran
	Parler dans le microphone

Allumer / Éteindre l'émetteur-récepteur

  Allumer l'émetteur-récepteur



Un signal sonore se fait entendre. Le canal actuellement programmé est affiché à l'écran.



Éteindre l'émetteur-récepteur

Réglage du volume sonore

 ou  Plus fort ou plus faible

Éclairage de l'écran

Après avoir appuyé sur une touche, exceptées la touche  et la touche ' , l'écran s'allume pendant 4 secondes.

Comment utiliser l'émetteur-récepteur ?

Émettre et recevoir

Émettre



Émettre



Tenez l'émetteur-récepteur à environ 5 à 7 cm de votre bouche et parlez avec un volume sonore normal. Pour parler avec d'autres correspondants, tous les appareils doivent être réglés sur le même canal et sur le même code CTCSS.

Recevoir



Recevoir



Vous ne pouvez pas recevoir de signaux radio si vous appuyez longtemps sur la touche .

Signal de confirmation (Roger Beep)

Le signal de confirmation retentit quand vous relâchez la touche . Cela signale à votre correspondant que votre transmission est terminée.

Activer/ Désactiver le signal de confirmation



Activer le mode de programmation



Activer le signal de confirmation



Désactiver le signal de confirmation

Choix du canal



Activer le mode de programmation



Sélectionner le canal et confirmer

Canal	Fréquence (MHz)	Canal	Fréquence (MHz)
1	446.00625	5	446.05625
2	446.01875	6	446.06875
3	446.03125	7	446.08125
4	446.04375	8	446.09375

Comment utiliser l'émetteur-récepteur ?

CTCSS¹/DCS² (code d'appel)

Vous disposez de 38 codifications analogiques (CTCSS 1 - 38) et de 83 codifications numériques (DCS 1 - 83) par canal. Les utilisateurs radio ne peuvent communiquer les uns avec les autres que si le canal radio et le code d'appel des appareils concordent.



Le code d'appel est envoyé avec le message vocal normal sous la forme d'un signal inaudible. Pour le récepteur, la langue n'est transmise au haut-parleur que si le canal programmé et le code d'appel sont identiques aux données reçues (réglages de l'émetteur). Si, par hasard, un autre correspondant utilise le même code d'appel sur le même canal, veuillez passer avec votre correspondant sur un autre canal libre.

2 x 

Activer le mode de programmation

 ou , 

Sélectionner le code CTCSS et confirmer

ou

3 x 

Activer le mode de programmation

 ou , 

Sélectionner le code DCS et confirmer



Une exception est le code d'appel 0 (zéro). Avec ce réglage, toutes les communications peuvent être entendues sur le canal programmé. Pour pouvoir participer au contact radio, vous devez alors programmer le code d'appel correspondant.



¹ **CTCSS** : Continous Tone Coded Squelch System

² **DCS** : Digital Coded Squelch

Comment utiliser l'émetteur-récepteur ?

Rechercher un canal

L'appareil recherche des signaux sur les huit canaux et les codes d'appel dans une boucle sans fin. **SC** s'affiche. Si le contact radio est trouvé, la recherche du canal s'arrête.

- Appuyez sur la touche  pour participer au contact radio sur ce canal. L'émetteur-récepteur est réglé sur le canal et la recherche est terminée.
- Si vous n'appuyez pas sur la touche , la recherche de canal se poursuit cinq secondes après que plus aucun signal n'a été émis sur ce canal.

Démarrer la recherche d'un canal

5 x  Activer le mode de programmation

 Démarrer la recherche d'un canal

La recherche des canaux s'arrête à chaque canal sur lequel un signal est capté, indépendamment du code d'appel avec lequel ce signal a été émis.

Continuer la recherche d'un canal

 Poursuivre la recherche d'un canal

Rechercher les codes CTCSS

6 x  Activer le mode de programmation

Rechercher les codes CTCSS

La recherche de canaux s'arrête si un signal est émis avec un code d'appel CTCSS sur le canal programmé.

Rechercher les DCS

7 x  Activer le mode de programmation

 Rechercher les codes DCS

La recherche de canaux s'arrête si un signal est émis avec un code d'appel DCS sur le canal programmé.

Terminer la recherche d'un canal









 Terminer la recherche d'un canal

Comment utiliser l'émetteur-récepteur ?

Surveillance de deux canaux

Quand la surveillance à deux canaux est activée, l'émetteur-récepteur passe automatiquement d'un canal à l'autre jusqu'à ce qu'il ait trouvé un signal radio. Vous pouvez ainsi parler à deux correspondants sur des canaux séparés.



Démarrer la surveillance de deux canaux

12 x 	Activer le mode de programmation
 ou  , 	Sélectionner le canal supplémentaire et confirmer
 ou  , 	Modifier le code CTCSS et confirmer
 ou  , PTT	Modifier le code DCS et confirmer



Dans le cas de la surveillance à deux canaux, le canal actuellement programmé et le canal supplémentaire s'affichent en alternance.

Terminer la surveillance de deux canaux



12 x 	Activer le mode de programmation
 ou  OF, PTT	Terminer la surveillance de deux canaux

Émettre un signal d'appel

Le signal d'appel fait remarquer à d'autres correspondants que vous désirez entamer une communication, Pour cela, les autres correspondants doivent utiliser le même canal et le même code d'appel.

	Émettre le signal d'appel
--	---------------------------



Sélectionner le signal d'appel

8 x 	Activer le mode de programmation
 ou  , PTT	Sélectionner le signal d'appel et confirmer

Comment utiliser l'émetteur-récepteur ?

Fonction Écran

La fonction de l'écran vous permet de chercher des signaux faibles sur le canal actuellement programmé. Si vous recevez un signal étranger, passez sur un canal libre. Communiquez toujours avec d'autres correspondants sur un canal libre pour éviter les perturbations.

 et 	Écouter le canal
	Terminer l'écoute

Verrouillage du clavier

Le verrouillage des touches empêche la modification involontaire des programmations. Si le verrouillage du clavier est activé, le symbole  s'affiche.

Activer

 	Activer le verrouillage du clavier
---	------------------------------------

Désactiver

 	Désactiver le verrouillage du clavier
---	---------------------------------------

Son des touches

À chaque pression de touche, un signal de confirmation se fait entendre. Vous pouvez l'activer et le désactiver.

11 x 	Activer le mode de programmation
--	----------------------------------

 ou  ON, 	Activer le son des touches
--	----------------------------

 ou  OF, 	Désactiver le son des touches
--	-------------------------------

Chronomètre

Vous pouvez utiliser votre émetteur-récepteur comme chronomètre.

3 sec 	Activer le chronomètre
---	------------------------

	Démarrage / Arrêt / Continuer
---	-------------------------------

	Remise à zéro
---	---------------

3 sec 	Désactiver le chronomètre
---	---------------------------

Comment utiliser l'émetteur-récepteur ?

Mode VOX¹ (mode mains-libres)

Avec cette fonction, l'émetteur-récepteur commence à émettre automatiquement quand une voix ou un bruit est détecté.



Quand vous commencez à parler, l'émetteur-récepteur émet quelques instants après.

Sensibilité VOX

Pour le fonctionnement en mode VOX, vous pouvez sélectionner 3 degrés de sensibilité en fonction des **bruits ambiants**.

Niveau 1	Niveau 2	Niveau 3
Bruits ambiants forts	Bruits ambiants normaux	Bruits ambiants faibles

Activer le mode VOX (mains libres)

Pour parler, mains-libres, en mode **VOX¹**, il n'est pas nécessaire d'appuyer sur la touche **PTT** de l'émetteur-récepteur pour émettre.

4 x

Activer le mode de programmation

, **PTT**

Sélectionner la sensibilité VOX et confirmer

Désactiver le mode VOX

4 x

Activer le mode de programmation

OF , **PTT**

Désactiver le mode VOX

Kit oreillettes

Branchez le kit oreillettes sur le côté droit de l'émetteur-récepteur. Activez le mode VOX. Accrochez l'émetteur-récepteur à la ceinture et fixez le câble du kit oreillettes à vos vêtements de sorte que le microphone se trouve juste devant votre bouche. Vous pouvez maintenant émettre et recevoir les mains-libres.

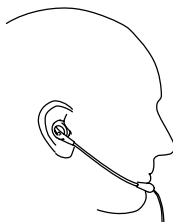

¹ **VOX** : Voice Operated Transmission = Détection de bruits

5 En cas de problèmes

Hotline de service

Si vous avez des problèmes avec votre émetteur-récepteur, contrôlez d'abord les points suivants. S'il s'agit de problèmes techniques, vous pouvez vous adresser à notre hotline de service en Suisse en appelant le numéro 0900 00 1675 (frais Swisscom à la date d'impression de ce manuel : CHF 2.60/min). Si vous avez des droits de garantie, adressez-vous à votre revendeur. La durée de la garantie est de 2 ans.

Questions et réponses

Questions	Réponses
Pas de fonction	<ul style="list-style-type: none">- Le pack de piles rechargeables n'est pas installé correctement- Le pack de piles rechargeables n'est pas chargé- Le pack de piles rechargeables est défectueux
Émission pas possible	<ul style="list-style-type: none">- Appuyez complètement sur la touche PTT pour émettre- Votre canal est utilisé par un autre correspondant
Pas de réception	<ul style="list-style-type: none">- Relâchez la touche PTT pour recevoir- Le volume sonore est réglé trop faiblement- Vous vous trouvez en dehors de la zone desservie, modifiez votre position- Des obstacles, comme des arbres ou des bâtiments, exercent une influence négative sur la portée- Servez-vous de la fonction "Écran" pour chercher des signaux faibles
Pas de communication possible	<ul style="list-style-type: none">- Pour parler avec d'autres correspondants, tous les appareils doivent être réglés sur le même canal et sur le même code d'appel.

Caractéristiques techniques

6 Caractéristiques techniques

Données techniques

Caractéristique	Valeur
Puissance de sortie	0.5 W
Portée	Env. 8 km - si ligne visuelle libre
Pack de piles rechargeables	NiMh 4.8V, 600mAh

Portée

Des obstacles, comme des arbres ou des bâtiments, exercent une influence négative sur la portée. Le croquis suivant indique la portée prévisible en fonction des différentes conditions.

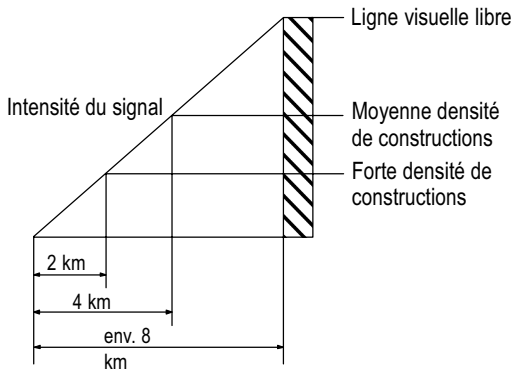

Déclaration de conformité

Cet appareil répond aux exigences des directives de l'union européenne (UE) :

1999/5/CE Directive sur les installations de radio et de télécommunication et la reconnaissance réciproque de leur conformité. La conformité avec la directive mentionnée ci-dessus est confirmée sur l'appareil par la marque CE.



7 Remarques d'entretien / Garantie

Remarques d'entretien

- Nettoyez les surfaces du boîtier avec un chiffon doux et non pelucheux.
- N'utilisez pas de produits nettoyants ou de solvants.

Garantie

Les appareils SWITEL sont fabriqués selon les procédés les plus modernes et sont contrôlés. Des matériels sélectionnés et des technologies de pointe ont pour effet un fonctionnement irréprochable et une longue durée de vie. La garantie ne s'étend pas aux piles, aux piles rechargeables ou aux packs de piles rechargeables utilisés dans les produits. La durée de garantie est de 24 mois à partir de la date d'achat.

Tous les vices provenant de défauts de fabrication ou de matériel seront éliminés gratuitement pendant la période de garantie. Le droit à la garantie expire en cas d'intervention de l'acheteur ou de tiers. Les dommages provenant d'un maniement ou d'une manipulation incorrects, d'une usure naturelle, d'une mauvaise mise en place ou d'une mauvaise conservation, d'un raccordement ou d'une installation incorrects ainsi que d'un cas de force majeure ou autres influences extérieures sont exclus de la garantie. En cas de réclamations, nous nous réservons le droit d'améliorer ou de remplacer les composants défectueux ou d'échanger l'appareil. Les composants remplacés ou les appareils échangés deviennent notre propriété. Les demandes de dommages et intérêts sont exclues tant qu'elles ne reposent pas sur l'intention ou une négligence grossière du fabricant.

Si votre appareil devait malgré tout présenter une déféctuosité pendant la période de garantie, veuillez vous adresser, muni de la quittance d'achat, exclusivement au magasin où vous avez acheté votre appareil SWITEL. Tous les droits de garantie basés sur ces dispositions ne peuvent être revendiqués qu'auprès de votre revendeur. A l'échéance des deux ans après l'achat et la remise de nos produits, les droits en matière de garantie ne sont plus applicables.

8 Index

A

Allumer, 28

B

Bruits ambiants, 34

C

Charge du pack
de piles rechargeables, 25

Choix du canal, 29

Chronomètre, 33

Consignes de sécurité, 22

Contenu du coffret, 24

D

Déclaration de conformité, 36

Données techniques, 36

E

Éclairage de l'écran, 28

Écran, 27

Éléments de manipulation, 27

Émettre, 29

Éteindre, 28

F

Fixer le clip de ceinture, 26

Fonction Écran, 33

G

Garantie, 37

H

Hotline de service, 35

K

Kit oreillettes, 34

M

Manipulation, 28

Mettre en place le pack
de piles rechargeables, 25

Mise en service de

l'émetteur-récepteur, 24

Mode économie d'énergie, 26

Mode mains-libres, 34

Mode VOX, 34

N

Notations, 28

P

Portée, 36

Problèmes, 35

Q

Questions et réponses, 35

R

Recevoir, 29

Rechercher un canal, 31

Réglage du volume sonore, 28

Remarques d'entretien, 37

Roger Beep, 29

S

Sélectionner

les codes CTCSS/DCS, 30

Sensibilité VOX, 34

Signal d'appel, 32

Signal de confirmation, 29

Son des touches, 33

Suppression d'erreurs, 35

Surveillance de deux canaux, 32

V

Verrouillage du clavier, 33

Contenuto

1	Indicazioni di sicurezza	40
2	Mettere in funzione i radiotrasmittitori	42
3	Elementi di comando	45
4	Come funzionano i miei radiotrasmittitori?	46
5	In presenza di problemi	54
6	Specifiche tecniche	55
7	Consigli per la cura / Garanzia	56
8	Indice alfabetico	57

Indicazioni di sicurezza

1 Indicazioni di sicurezza

Leggere attentamente le presenti istruzioni per l'uso.

Impiego conforme agli usi previsti

Questi ricetrasmittitori si prestano alla comunicazione con altri apparecchi ricetrasmittenti aventi lo stesso standard. Qualsiasi altro impiego è considerato come non conforme agli usi previsti. Non sono consentite modifiche o trasformazioni non autorizzate. Non aprire per nessuna ragione gli apparecchi autonomamente ed evitare di compiere riparazioni di propria iniziativa.

Ambito di impiego

Evitare un'esposizione a fumo, polvere, vibrazioni, sostanze chimiche, umidità, calore e raggi solari diretti.

Non utilizzare i radiotrasmittitori in aree esposte al rischio di deflagrazione.

Alimentatore di rete



Attenzione: Utilizzare esclusivamente l'alimentatore a spina fornito in dotazione visto che altri alimentatori di rete potrebbero distruggere i radiotrasmittitori. Non ostacolare il libero accesso all'alimentatore a spina con mobili o altri oggetti simili.

Accumulatori ricaricabili



Attenzione: Non gettare gli accumulatori ricaricabili nel fuoco. Utilizzare solo accumulatori dello stesso tipo. Osservare la corretta polarità! Pericolo di esplosione durante il caricamento degli accumulatori in caso di errata polarità.

Apparecchiature mediche



Attenzione: Evitare di utilizzare i radiotrasmittitori in vicinanza di apparecchiature mediche. Non è infatti possibile escludere il rischio di possibili interferenze. Radiotrasmittitori possono causare un fastidioso ronzio in apparecchi acustici.

Smaltimento

Procedere allo smaltimento dell'apparecchio esaurito consegnandolo presso uno dei punti di raccolta istituiti dalla propria società di smaltimento rifiuti comunale (ad es. centro di riciclo materiali). Secondo quanto previsto dalla legge sugli apparecchi elettrici ed elettronici, i proprietari di apparecchi esauriti sono per legge tenuti alla consegna di tutti gli **apparecchi elettrici ed elettronici** presso un centro di rilievo rifiuti in raccolta differenziata. Il simbolo riportato qui a lato indica che non è assolutamente consentito smaltire l'apparecchio assieme ai normali rifiuti domestici!



Accumulatori e batterie possono provocare danni alla salute e all'ambiente!



Non aprire, danneggiare, ingerire o disperdere nell'ambiente accumulatori e batterie. Questi possono contenere metalli pesanti nocivi e dannosi per l'ambiente. Per legge sussiste l'obbligo di consegnare accumulatori e batterie presso i rivenditori di batterie utilizzando gli appositi contenitori di raccolta e provvedendo in tal modo al corretto smaltimento. Lo smaltimento è gratuito. I simboli indicano che non è assolutamente consentito gettare accumulatori e batterie nei rifiuti domestici, consegnandoli ai fini dello smaltimento nei rispettivi punti di raccolta.

Smaltire **confezioni ed imballaggi** in base a quanto indicato dalle norme in vigore a livello locale.

Mettere in funzione i radiotrasmettitori

2 Mettere in funzione i radiotrasmettitori

Indicazioni di sicurezza



Attenzione: Prima della messa in funzione, leggere attentamente le indicazioni di sicurezza riportate al capitolo 1.

Verificare il contenuto della confezione

La confezione comprende:

- due radiotrasmettitori con gancio per cintura
- due accumulatori ricaricabili
- un manuale di istruzioni per l'uso
- un alimentatore di rete (cavo di carica)

Collegare il radiotrasmettitore direttamente

Procedere al collegamento del radiotrasmettitore seguendo quanto raffigurato sul disegno. Per motivi di sicurezza si prega di utilizzare soltanto l'alimentatore di rete fornito in dotazione.

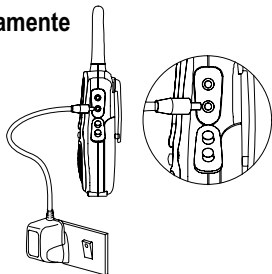

Mettere in funzione i radiotrasmettitori

Inserire l'accumulatore ricaricabile

Aprire il vano accumulatori. Inserire l'accumulatore ricaricabile fornito in dotazione. Osservare la corretta polarità! Chiudere quindi il vano accumulatori.



Attenzione: Accumulatori e batterie standard non sono ricaricati nella stazione di carica. Utilizzare solo l'accumulatore ricaricabile fornito in dotazione o accumulatori ricaricabili dello stesso tipo.

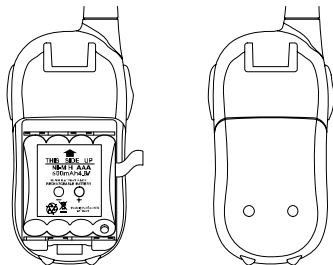

Caricare l'accumulatore ricaricabile

Caricare i radiotrasmettitori prima della messa in funzione per minimo 14 ore.



Evitare di caricare gli accumulatori ricaricabili con dispositivi di carica differenti o estranei.

La capacità di carica degli accumulatori è indicata sul display con il simbolo

Carico



Metà carico



Debole



Scarico



Non appena l'indicazione sul display lampeggia e si avvertono dei suoni di avviso è necessario provvedere alla ricarica del pacco batteria.

Mettere in funzione i radiotrasmittitori

Modo di risparmio energetico

Il radiotrasmittitore è dotato di modo di risparmio energetico allo scopo di prolungare la durata in vita del pacco batteria utilizzato all'interno del dispositivo. Non premendo per oltre 4 secondi alcun tasto sul radiotrasmittitore, l'apparecchio passa al modo di risparmio energetico. Premendo invece un tasto o se si riceve un segnale, il modo di risparmio energetico è di nuovo disattivato.

Applicare il gancio per cintura

Introdurre il gancio per cintura dall'alto nella guida fino a farlo scattare in posizione. Per rimuovere nuovamente il gancio per cintura, sollevare leggermente la linguetta di fissaggio con l'unghia del dito spingendo il gancio per cintura verso sopra.

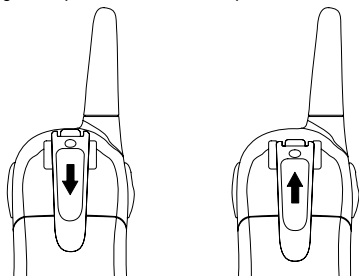

3 Elementi di comando

I tasti del radiotrasmittitore riportati nel presente manuale d'istruzioni per l'uso sono raffigurati sotto forma di simboli uniformi. Sono pertanto possibili lievi scostamenti dei simboli dei tasti sul radiotrasmittitore rispetto ai simboli qui raffigurati.

Radiotrasmittitore

- 1 Display
- 2 Collegamento auricolare
- 3 Collegamento cavo di caricamento
- 4 ON / OFF
- 5 Menu
- 6 Microfono
- 7 Volume / Impostazione +
- 8 Altoparlante
- 9 Volume / Impostazione -
- 10 Invio segnale di chiamata
- 11 Tasto di conversazione PTT
- 12 Antenna

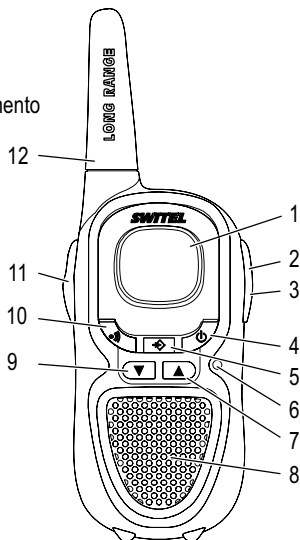

Display

- 1 Funzione ricerca di canale
- 2 Trasmettere
- 3 DCS¹ attivo
- 4 CTCSS² attivo
- 5 Codice CTCSS/DCS
- 6 Volume
- 7 Modalità VOX³
- 8 Segnalazione
- 9 Monitoraggio dual watch
- 10 Blocco tastiera
- 11 Capacità di carica dell'accumulatore
- 12 Canale
- 13 Ricevere

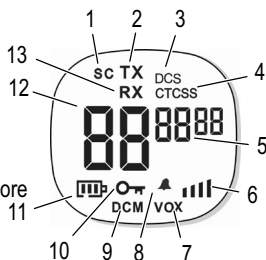

¹ **DCS: Digital Coded Squelch**









² **CTCSS: Continous Tone Coded Squelch System**

³ **VOX: Voice Operated Transmission = Rilevamento rumori**





Come funzionano i miei radiotrasmittitori?

4 Come funzionano i miei radiotrasmittitori?



Rappresentazioni e modi di scrittura

	Premere il tasto raffigurato
2 sec 	Premere il tasto raffigurato per 2 secondi
2 x 	Premere il tasto raffigurato 2 volte
 	Tenere premuto il tasto raffigurato
 	Rilasciare il tasto raffigurato
	Visualizzazioni di display
	Parlare rivolti verso il microfono



Attivare / Disattivare i radiotrasmittitori

 	Attivare il radiotrasmittitore
	Si avverte un segnale acustico. Il canale attualmente impostato è visualizzato sul display.
 	Disattivare il radiotrasmittitore

Regolazione del volume

 o 	Volume più alto o più basso
---	-----------------------------

Retroilluminazione del display

Dopo aver premuto un tasto, eccezion fatta per il tasto  e il tasto , il display si accende per una durata di 4 secondi.

Come funzionano i miei radiotrasmittitori?

Trasmettere e ricevere

Trasmettere



Trasmettere



Mantenere con il radiotrasmittitore una distanza di ca. 5 - 7 cm dalla bocca e parlare con voce normale. Per poter comunicare con altri interlocutori, tutti i radiotrasmittitori devono essere impostati sullo stesso canale e sullo stesso codice CTCSS.

Ricevere



Ricevere



Non è possibile ricevere alcun segnale radio se si tiene premuto il tasto **PTT**.

Segnale acustico di conferma (Roger Beep)

Il segnale acustico di conferma risuona rilasciando il tasto **PTT**. In tal modo al proprio partner di chiamata si segnala la conclusione della trasmissione.

Attivare / Disattivare il segnale acustico di conferma



Attivare la modalità di impostazione



Attivare il segnale acustico di conferma



Disattivare il segnale acustico di conferma

Selezione del canale



Attivare la modalità di impostazione



Selezionare il canale e confermare

Canale	Frequenza (MHz)	Canale	Frequenza (MHz)
1	446.00625	5	446.05625
2	446.01875	6	446.06875
3	446.03125	7	446.08125
4	446.04375	8	446.09375

Come funzionano i miei radiotrasmittitori?

Selezione del codice CTCSS¹/DCS² (codifica di chiamata)

Sono disponibili 38 codifiche analogiche (CTCSS 1 - 38) e 83 codifiche digitali (DCS 1 - 83) per ogni singolo canale. Gli utenti di radiotrasmittitori sono in grado di comunicare tra di loro nel momento in cui su tutti gli apparecchi risultano impostati canale radio e codifica di chiamata uguali.



La codifica di chiamata è trasmessa come segnale non udibile assieme al normale messaggio vocale. Il parlato è trasferito sull'altoparlante del ricevitore solo se canale selezionato e codifica di chiamata dei dati ricevuti/trasmessi risultano identici (impostazioni del trasmettitore). Qualora altre persone utilizzassero già per puro caso sullo stesso canale la stessa codifica di chiamata, si prega di passare su un canale libero assieme al proprio interlocutore.

2 x

Attivare la modalità di impostazione

o ,

Selezionare il codice CTCSS e confermare

oppure

3 x

Attivare la modalità di impostazione

o ,

Selezionare il codice DCS e confermare



La codifica di chiamata 0 (zero) costituisce un'eccezione. La presente impostazione consente l'ascolto di tutte le conversazioni sul canale impostato. Per poter partecipare alla comunicazione via radio si rende necessario impostare la codifica di chiamata richiesta dalla situazione.



¹ **CTCSS**: Continous Tone Coded Squelch System

² **DCS**: Digital Coded Squelch

Come funzionano i miei radiotrasmettitori?

Ricerca del canale

Sia la ricerca del canale su tutti gli 8 canali che la codifica di chiamata sulla base di segnali sono eseguite in ciclo continuo. Sul display appare l'indicazione **SC**. Non appena l'apparecchio individua comunicazioni via radio, la ricerca di canale è interrotta.

- Premere quindi il tasto  per partecipare alla comunicazione via radio su questo canale. Il radiotrasmettitore passa al canale interessato mentre la ricerca di canale è conclusa.
- Non premendo il tasto , la ricerca di canale è proseguita trascorsi cinque secondi dopo che l'apparecchio non rivela alcun segnale anche da questo canale.

Avviare la ricerca del canale

5 x  Attivare la modalità di impostazione

 Avviare la ricerca di canale

La ricerca di canale si ferma ogni volta che viene individuato un canale da cui è ricevuto un segnale, indipendentemente dalla codifica di chiamata con cui il segnale è trasmesso.

Proseguire la ricerca di canale

 Proseguire la ricerca di canale

Scorrere i codici CTCSS

6 x  Attivare la modalità di impostazione

 Scorrere i codici CTCSS

La ricerca di canale si ferma non appena sul canale impostato viene individuato un segnale con codifica di chiamata CTCSS.

Scorrere i codici DCS

7 x  Attivare la modalità di impostazione

 Scorrere i codici DCS

La ricerca di canale si ferma non appena sul canale impostato viene individuato un segnale con codifica di chiamata DCS.

Concludere la ricerca del canale











 Concludere la ricerca di canale

Come funzionano i miei radiotrasmittitori?

Monitoraggio dual watch

Con monitoraggio dual watch attivato il radiotrasmittitore passa automaticamente da un canale impostato all'altro, fino a individuare un segnale radio. In tal modo è possibile conversare con due partner di chiamata su canali distinti.





Avviare il monitoraggio dual watch

12 x 	Attivare la modalità di impostazione
 o  , 	Selezionare un canale aggiuntivo e confermare
 o  , 	Modificare il codice CTCSS e confermare
 o  , 	Modificare il codice DCS e confermare



In sede di controllo a due canali, il canale attualmente impostato e il canale supplementare sono visualizzati sul display in alternanza.

Concludere il monitoraggio dual watch





12 x 	Attivare la modalità di impostazione
 o  ,  , 	Concludere il monitoraggio dual watch

Trasmettere il segnale di chiamata

Il segnale di chiamata richiama l'attenzione degli altri interlocutori indicando che il chiamante desidera avviare una conversazione. A tal fine è necessario che gli altri interlocutori utilizzino lo stesso canale e la stessa codifica di chiamata.

	Trasmettere un segnale di chiamata
---	------------------------------------

Selezionare un segnale di chiamata

8 x 	Attivare la modalità di impostazione
 o  , 	Selezionare il segnale di chiamata e confermare

Come funzionano i miei radiotrasmittitori?

Funzione schermo

La funzione schermo consente di individuare sul canale attualmente impostato la presenza di segnali deboli. In caso di ricezione di un segnale estraneo, si passa ad un canale libero. Si consiglia di comunicare con altri interlocutori sempre su un canale libero onde evitare interferenze.

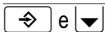

Ascoltare un canale



Concludere l'ascolto

Blocco tastiera

Il blocco tastiera impedisce di compiere modifiche non intenzionali alle impostazioni. Con blocco tastiera inserito sul display appare il simbolo .

Attivare



Attivare il blocco tastiera

Disattivare



Disattivare il blocco tastiera

Suono tasti

Ogni volta che si preme un tasto si avverte un segnale acustico di conferma. Il suono tasti può essere attivato e disattivato.



Attivare la modalità di impostazione



Attivare il suono tasti

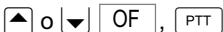

Disattivare il suono tasti

Come funzionano i miei radiotrasmittitori?

Cronometro

I radiotrasmittitori possono altresì essere utilizzati come cronometro.

3 sec 

Attivare il cronometro



Avvio / Stop / Continua



Ripristinare

3 sec 

Disattivare il cronometro

Modalità VOX¹ (funzione vivavoce)

Questa funzione consente al radiotrasmittitore di trasmettere automaticamente, non appena è rilevata una voce o un rumore.



Appena si inizia la conversazione subentra un breve ritardo, prima che il radiotrasmittitore proceda alla trasmissione.

Sensibilità VOX

Per l'esercizio in modalità VOX è possibile scegliere fra 3 livelli di sensibilità relativi alla riproduzione di **rumori dell'ambiente circostante**.

Livello 1	Livello 2	Livello 3
rumori circostanti forti	rumori circostanti normali	rumori circostanti lievi

Attivare la modalità VOX

Con funzione vivavoce in modalità **VOX** non è consentito premere il tasto  sul radiotrasmittitore a scopo di trasmissione.

4 x 

Attivare la modalità di impostazione

, 

Selezionare la sensibilità VOX e confermare

Disattivare la modalità VOX

4 x 

Attivare la modalità di impostazione

, , 

Disattivare la modalità VOX

¹ **VOX:** Voice Operated Transmission = Rilevamento rumori

Come funzionano i miei radiotrasmittitori?

Auricolare

Collegare l'auricolare sul lato destro del radiotrasmittitore. Attivare la modalità VOX. Agganciare il radiotrasmittitore alla cintura e fissare il cavo dell'auricolare agli indumenti in modo che il microfono si trovi all'altezza della propria bocca. A questo punto è possibile ricevere e trasmettere a mani libere.

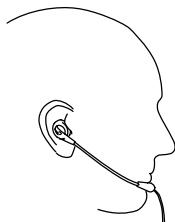

In presenza di problemi

5 In presenza di problemi

Hotline di assistenza

In presenza di problemi con il radiotrasmittitore, seguire le indicazioni riportate qui di seguito. In caso di problemi tecnici è possibile rivolgersi alla nostra hotline di assistenza tecnica chiamando al numero 0900 00 1675 valido per la Svizzera (spese da rete Swisscom alla data di stampa: CHF 2.60 / min). In caso di reclami entro il periodo di garanzia, rivolgersi al rivenditore autorizzato. Il periodo di garanzia ricopre 2 anni.

Domande e risposte

Domande	Risposte
Nessuna funzione	<ul style="list-style-type: none">- Il pacco batteria non è stato inserito correttamente- Il pacco batteria non è carico- Il pacco batteria è difettoso
Trasmissione non è possibile	<ul style="list-style-type: none">- Premere completamente il tasto <input type="button" value="PTT"/> per trasmettere- Il canale è utilizzato da un altro interlocutore
Nessuna ricezione	<ul style="list-style-type: none">- Rilasciare il tasto <input type="button" value="PTT"/> per ricevere- Il volume è impostato ad un livello troppo basso- Si è al di fuori del campo di ricezione, modificare la propria posizione- Eventuali ostacoli come alberi ed edifici hanno un influsso negativo sulla portata- Servirsi della funzione "Schermo" per individuare la presenza di segnali deboli
Non è possibile comunicare	<ul style="list-style-type: none">- Per poter comunicare con altri interlocutori, tutti i radiotrasmittitori devono essere impostati sullo stesso canale e sulla stessa codifica di chiamata.

6 Specifiche tecniche

Specifiche tecniche

Caratteristica	Valore
Potenza di uscita	0.5 W
Portata	ca. 8 km - con linea di mira libera
Accumulatore ricaricabile	NiMh 4.8V, 600mAh

Portata

Eventuali ostacoli come alberi ed edifici hanno un influsso negativo sulla portata. Il seguente schema indica la portata prevista tenuto conto di differenti e possibili condizioni.

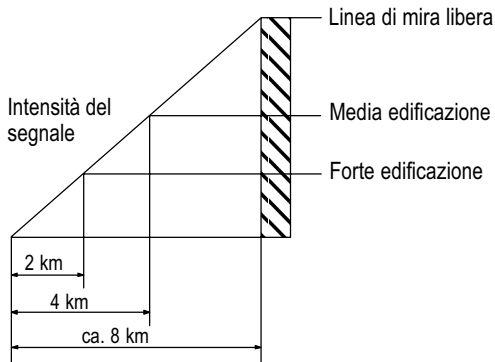

Dichiarazione di conformità

Questo apparecchio risponde a quanto disposto dalla Direttiva UE:

1999/5/CE Direttiva concernente le apparecchiature radio, le apparecchiature terminali di telecomunicazioni e il reciproco riconoscimento della loro conformità. La conformità con la Direttiva di cui sopra viene confermata dal marchio CE applicato sull'apparecchio.



Consigli per la cura / Garanzia

7 Consigli per la cura / Garanzia

Consigli per la cura

- Pulire le superfici degli apparecchi con un panno morbido e antipelucchi.
- Non utilizzare mai detergenti o solventi.

Garanzia

Gli apparecchi SWITEL sono costruiti e collaudati in osservanza dei processi di produzione più moderni. L'impiego di materiali selezionati e tecnologie altamente sviluppate sono garanti di una perfetta funzionalità e lunga durata in vita. La garanzia non si estende a batterie, accumulatori o batterie ricaricabili utilizzati all'interno degli apparecchi. Il periodo di garanzia ricopre 24 mesi a partire dalla data di acquisto.

Entro il periodo di garanzia si procederà all'eliminazione gratuita di tutti i guasti dovuti a difetti di materiale o produzione. Il diritto di garanzia cessa in caso di interventi da parte dell'acquirente o di terzi. Danni derivanti da un impiego o esercizio non conforme agli usi previsti, a naturale usura, a errato montaggio o errata conservazione, a collegamento o installazione impropri, dovuti a forza maggiore o ad altri influssi esterni non sono coperti da garanzia. In qualità di produttore ci riserviamo il diritto, in caso di reclami, di riparare o sostituire le parti difettose o di rimpiazzare l'apparecchio. Parti o apparecchi sostituiti passano di nostra proprietà. Sono esclusi diritti di risarcimento per danni qualora non siano dovuti a intenzione o colpa grave del costruttore.

Nel caso in cui il presente apparecchio dovesse ciò nonostante presentare un difetto durante il periodo di garanzia, si prega di rivolgersi esclusivamente al negozio di rivendita dell'apparecchio SWITEL assieme al relativo scontrino di acquisto. In base alle presenti disposizioni, tutti i diritti di garanzia dovranno essere fatti valere esclusivamente nei confronti del rivenditore autorizzato. Decorso il termine di due anni dalla data di acquisto e consegna dei nostri prodotti non sarà più possibile fare valere alcun diritto di garanzia.

8 Indice alfabetico

A

Applicare il gancio per cintura, 44
Attivare, 46
Auricolare, 53

B

Blocco tastiera, 51

C

Caricare l'accumulatore ricaricabile, 43
Codice CTCSS/DCS, 48
Consigli per la cura, 56
Contenuto della confezione, 42
Cronometro, 52

D

Dichiarazione di conformità, 55
Disattivare, 46
Display, 45
Domande e risposte, 54

E

Elementi di comando, 45
Eliminare guasti, 54
Esercizio, 46

F

Funzione schermo, 51
Funzione vivavoce, 52

G

Garanzia, 56

H

Hotline di assistenza, 54

I

Indicazioni di sicurezza, 40
Inserire l'accumulatore ricaricabile, 43

M

Mettere in
funzione i radiotrasmittitori, 42
Modalità VOX, 52
Modi di scrittura, 46
Modo di risparmio energetico, 44
Monitoraggio dual watch , 50

P

Portata, 55
Problemi, 54

R

Regolazione del volume, 46
Retroilluminazione del display, 46
Ricerca del canale, 49
Ricevere, 47
Roger Beep, 47
Rumori dell'ambiente circostante, 52

S

Segnale acustico di conferma, 47
Segnale di chiamata, 50
Selezione del canale, 47
Sensibilità VOX, 52
Specifiche tecniche, 55
Suono tasti, 51

T

Trasmettere, 47

Contents

1	Safety Information	60
2	Preparing the Walkie-Talkies for Use .	62
3	Operating Elements	65
4	Operating the Walkie-Talkies	66
5	In Case of Problems	73
6	Technical Properties	74
7	Maintenance / Guarantee	75
8	Index	76

Safety Information

1 Safety Information

Please read this operating instruction manual thoroughly.

Intended use

These walkie-talkies have been conceived for communication with other walkie-talkies complying to the same standards. Any other use is considered unintended use. Unauthorised modification or reconstruction is not permitted. Under no circumstances open the devices or complete any repair work yourself.

Ambient conditions

Prevent excessive exposure to smoke, dust, vibration, chemicals, moisture, heat and direct sunlight.

Do not use the walkie-talkies in potentially explosive areas.

Power adapter plug



Attention: Only use the power adapter plug supplied because other adapter plugs could damage the walkie-talkies. Ensure access to the power adapter plug is not obstructed by furniture or such.

Rechargeable batteries



Attention: Never throw batteries into a fire. Only use batteries of the same type. Pay attention to correct polarity. Incorrect polarity of the batteries represents a risk of explosion during charging.

Medical equipment



Attention: Never use the walkie-talkies in the vicinity of medical equipment. Effects on such equipment cannot be fully ruled out. Walkie-talkies can cause an unpleasant humming sound in hearing aids.

Disposal

In order to dispose of your device, take it to a collection point provided by your local public waste authorities (e.g. recycling centre). According to laws on the disposal of electronic and electrical devices, owners are obliged to dispose of old **electronic and electrical devices** in a separate waste container. The adjacent symbol indicates that the device must not be disposed of in normal domestic waste!



Batteries represent a hazard to health and the environment!



Never open, damage or swallow batteries or allow them to pollute the environment. They may contain toxic, ecologically hazardous heavy metals. You are legally obliged to dispose of power packs and batteries at the point of sale or in the corresponding containers provided at collection points by local public waste authorities. Disposal is free of charge. The symbols indicate that the batteries must not be disposed of in normal domestic waste and that they must be brought to collection points provided by local public waste authorities.

Packaging materials must be disposed of according to local regulations.

Preparing the Walkie-Talkies for Use

2 Preparing the Walkie-Talkies for Use

Safety information



Attention: It is essential to read the Safety Information in Chapter 1 before starting up.

Checking the package contents

The package contains:

- two walkie-talkies with belt clip
- two rechargeable battery packs
- an operating manual
- a power adapter plug (charger cable)

Connecting the walkie-talkie directly to the power socket

Connect the walkie-talkie as illustrated in the diagram. For safety reasons, only use the power adapter plug supplied.

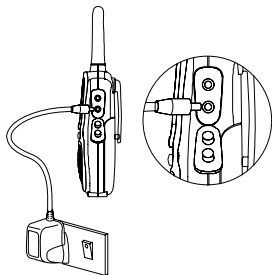

Preparing the Walkie-Talkies for Use

Inserting the battery pack

Open the battery compartment. Insert the battery pack supplied. Pay attention to correct polarity. Close the battery compartment.



Attention: Standard rechargeable batteries and power packs cannot be charged in the charging station. Only use the battery packs supplied or ones of the same type.

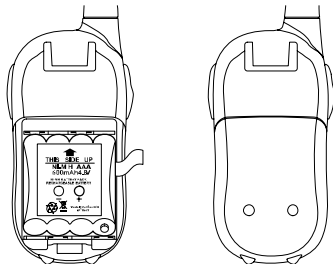

Charging the battery pack

Before using the walkie-talkies for the first time, charge them for at least 14 hours.



Do not charge the walkie-talkies with charging units from other manufacturers.

The battery capacity is indicated in the display by the  icon.

Full



Half empty



Low



Empty



The battery pack needs to be recharged as soon as the indicator flashes in the display and acoustic warning signals are issued.

Preparing the Walkie-Talkies for Use

Energy-save mode

Your walkie-talkies are provided with an energy-save mode to increase the service life of the batteries. If no buttons on the walkie-talkies are pressed for a period of 4 seconds, energy-save mode is activated. Energy-save mode is deactivated as soon as you press a button or a signal is received.

Attaching the belt clips

Slide the belt clip in the guide from the top until it audibly snaps into place. To detach the belt clip, prize the fastening tab up a little with your fingernail and slide the belt clip upwards.

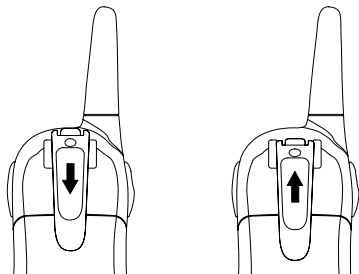

3 Operating Elements

The buttons in this operating manual are subsequently depicted with a uniform contour. Therefore, slight deviations in the appearance of the symbols on the walkie-talkie buttons compared to those depicted here are possible.

Walkie-talkie

- 1 Display
- 2 Headset connection socket
- 3 Power adapter cable socket
- 4 On / Off
- 5 Menu
- 6 Microphone
- 7 Volume / Setting +
- 8 Loudspeaker
- 9 Volume / Setting -
- 10 Transmit ringing tones
- 11 PTT - Talk button
- 12 Antenna

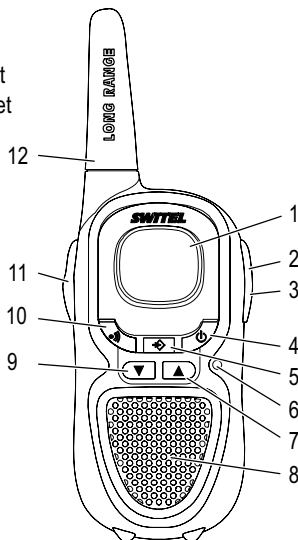

Display

- 1 Scanning channels
- 2 Transmitting
- 3 DCS¹ active
- 4 CTCSS² active
- 5 CTCSS / DCS code
- 6 Volume control
- 7 VOX³ mode
- 8 Alarm/Alert
- 9 Dual channel monitoring
- 10 Key lock
- 11 Battery capacity
- 12 Channel
- 13 Receiving

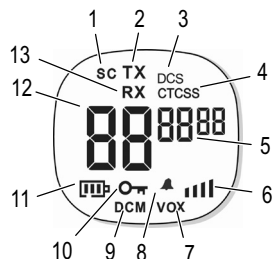

¹ **DCS: Digital Coded Squelch**









² **CTCSS: Continous Tone Coded Squelch System**

³ **VOX: Voice Operated Transmission**



Operating the Walkie-Talkies

4 Operating the Walkie-Talkies

Display and notation of operating sequences

	Press the button depicted
2 sec 	Press the button depicted for 2 seconds
2 x 	Press the button depicted twice
 	Press and hold the button depicted
 	Release the button depicted
	Text in the display
	Speak into the microphone



Switching the walkie-talkie on/off

	Switch the walkie-talkie on
	An acoustic signal is issued. The current channel setting appears in the display.
	Switch the walkie-talkie off

Volume control

 or 	Raise or lower the volume
--	---------------------------

Display illumination

The display lights up for 4 seconds after pressing any button, except the  and  buttons.

Operating the Walkie-Talkies

Transmitting and receiving

Transmitting



Transmit



Hold the walkie-talkie approx. 5 to 7 cm from your mouth and speak at a normal volume. In order to talk to other subscribers, the respective walkie-talkies must be set to the same channel and CTCSS code.

Receiving



Receive



Radio signals cannot be received when the button is being pressed.

Confirmation signal (Roger beep)

The confirmation signal is issued on releasing the button. This signals to the caller that you have ended transmission.

Activating/Deactivating the confirmation signal



Activate the programming mode



Activate the confirmation signal



Deactivate the confirmation signal

Selecting a channel



Activate the programming mode



Select the channel and confirm it

Channel	Frequency (MHz)	Channel	Frequency (MHz)
1	446.00625	5	446.05625
2	446.01875	6	446.06875
3	446.03125	7	446.08125
4	446.04375	8	446.09375

Operating the Walkie-Talkies

Selecting the CTCSS¹/DCS² code

There are 38 analogue (CTCSS 1 - 38) and 83 digital (DCS 1 - 83) codes available per channel. It is only possible to communicate using the walkie-talkies when they are each set to the same channel and CTCSS/DCS code.



The CTCSS/DCS codes are transmitted as inaudible signals together with the standard voice communication. When received, the voice communication signal is only transferred to the loudspeaker when the channel and CTCSS/DCS code set on the receiver are identical to that of those received (settings on the transmitter). If, by coincidence, another subscriber is using the same channel and CTCSS code, change to a free channel together with the party being called.

2 x

Activate the programming mode

or ,

Select the CTCSS code and confirm it

or

3 x

Activate the programming mode

or ,

Select the DCS code and confirm it



An exception here is CTCSS/DCS code 0 (zero). When this setting is set, all calls made on the channel set can be heard. In order to participate in the radio communication, you must set the corresponding CTCSS code.



¹ **CTCSS:** Continous Tone Coded Squelch System = Selective calling

² **DCS:** Digital Coded Squelch = Selective calling

Operating the Walkie-Talkies

Scanning for a channel

Signals are searched for on all eight channels and all CTCSS codes in a continuous cycle. **SC** appears in the display. Channel scanning is stopped if radio communication is found.

- Press the  button to enable radio communication on this channel. The walkie-talkie is set to the channel and channel scanning is ended.
- If you do not press the  button, channel scanning is resumed five seconds after no further signal has been transmitted on this channel.

Starting channel scanning

5 x  Activate the programming mode

 Start channel scanning

The scanning routine stops at every channel on which a signal is received regardless of the CTCSS/DCS code transmitted with the signal.

Resuming channel scanning

 Resume scanning for a channel

Scanning the CTCSS codes

6 x  Activate the programming mode

 Scan the CTCSS codes

The scanning process stops when a signal with a CTCSS code is transmitted on the set channel.

Scanning the DCS codes

7 x  Activate the programming mode

 Scan the DCS codes

The scanning process stops when a signal with a DCS code is transmitted on the set channel.

Stopping channel search











 End channel scanning

Operating the Walkie-Talkies

Dual-channel monitoring

When dual-channel monitoring is activated, the walkie-talkie automatically switches between two channels until a communication signal is detected. This means you can talk to two callers on separate channels.





Starting dual-channel monitoring

12 x 	Activate the programming mode
 or  , 	Select the additional channel and confirm it
 or  , 	Change the CTCSS code and confirm it
 or  , 	Change the DCS code and confirm it



When dual-channel monitoring is active, the channel currently set and the additional channel appear alternately in the display.

Ending dual-channel monitoring





12 x 	Activate the programming mode
 or  ,  , 	End dual-channel monitoring

Transmitting the ringing tone

The ringing tones indicate to other subscribers that you want to talk to them. A condition for this is that the other subscribers are using the same channel and CTCSS code.

	Transmit ringing tones
---	------------------------



Selecting the ringtone

8 x 	Activate the programming mode
 or  , 	Select the ringing tone and confirm it

Operating the Walkie-Talkies

Monitor function

The Monitor function enables the search for weak signals on the channel currently set. If you receive an external signal, switch to a free channel. Always communicate with other subscribers on a free channel to prevent interference.

 and 	Start monitoring the channel
	Deactivate channel monitoring

Key lock

The key lock function prevents inadvertent modification of settings. When the key lock function is activated, the  icon flashes in the display.

Activating

 	Activate the key lock function
---	--------------------------------

Deactivating



 	Deactivate the key lock function
---	----------------------------------

Key tone

An acoustic confirmation signal is issued each time a button is pressed. This key tone can be switched on or off.

11 x 	Activate the programming mode
--	-------------------------------

 or  ON , 	Activate the key tones
--	------------------------

 or  OF , 	Deactivate the key tones
--	--------------------------

Stopwatch

The walkie-talkies can be used as stopwatches.

3 sec 	Activate the stopwatch function
---	---------------------------------

	Start / Stop / Resume
---	-----------------------

	Reset
---	-------

3 sec 	Deactivate the stopwatch function
---	-----------------------------------

Operating the Walkie-Talkies

VOX¹ mode (handsfree)

When this function is active, the walkie-talkie automatically starts to transmit when the unit detects a voice or a sound.



When you start to speak, there is a slight delay before the walkie-talkie starts to transmit.

VOX sensitivity

There are three sensitivity levels available for operation in VOX mode and can be selected according to the **ambient noise**.

Level 1	Level 2	Level 3
High ambient noise	Normal ambient noise	Low ambient noise

Activating VOX mode

When using the handsfree function in **VOX** mode, the **PTT**-button on the walkie-talkie must not be pressed to transmit.

4 x	Activate the programming mode
, PTT	Select the VOX sensitivity and confirm it

Deactivating VOX mode

4 x	Activate the programming mode
OF , PTT	Deactivate VOX mode

Headset

Connect the headset on the right-hand side of the walkie-talkie. Activate VOX mode. Clip the walkie-talkie on your belt and fix the headset cable to a piece of your clothing so that the microphone is positioned near your mouth. You can now transmit and receive without needing to use your hands.

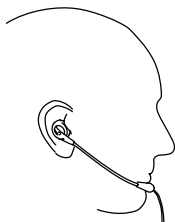

5 In Case of Problems

Service hotline

Should problems arise with the walkie-talkies, please refer to the following information first. In the case of technical problems, you can contact our hotline service, Tel. 0900 00 1675 within Switzerland (Swisscom fees at time of going to print: CHF 2.60/min). In the case of claims under the terms of guarantee, please contact your sales outlet. There is a 2 year period of guarantee.

Problems and solutions

Problems	Solutions
Equipment does not function	<ul style="list-style-type: none">- The battery pack is not inserted correctly- The battery pack is not charged- The battery pack is defect
Transmission not possible	<ul style="list-style-type: none">- Press the <input type="button" value="PTT"/> button in fully in order to transmit- The channel is being used by other subscribers
No reception	<ul style="list-style-type: none">- Release the <input type="button" value="PTT"/> button in order to receive- The volume is set too low- You are outside the range of reception, change your position- Obstructions such as trees and buildings impair the range- Use the "Monitor" function to search for weak signals
No communication possible	<ul style="list-style-type: none">- In order to talk to other subscribers, the respective walkie-talkies must be set to the same channel and CTCSS/DCS code.

Technical Properties

6 Technical Properties

Technical data

Feature	Value
Output power	0.5 W
Range	Approx. 8 km in open space
Battery pack	NiMh 4.8 V, 600 mAh

Range

Obstructions such as trees and buildings impair the range. The following diagram indicates the range which can be expected under different conditions.

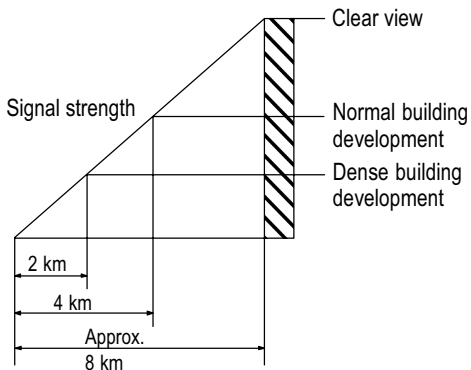

Declaration of Conformity

This device fulfils the requirements stipulated in the EU directive:

1999/5/EC directive on radio equipment and telecommunications terminal equipment and the mutual recognition of their conformity. Conformity with the above mentioned directive is confirmed by the CE mark on the device.



7 Maintenance / Guarantee

Maintenance

- Clean the housing surfaces with a soft, fluff-free cloth.
- Never use cleaning agents or solvents.

Guarantee

SWITEL equipment is produced and tested according to the latest production methods. The implementation of carefully chosen materials and highly developed technologies ensure trouble-free functioning and a long service life. The terms of guarantee do not apply to the batteries or power packs used in the products. The period of guarantee is 24 months from the date of purchase.

All deficiencies related to material or manufacturing errors within the period of guarantee will be redressed free of charge. Rights to claims under the terms of guarantee are annulled following tampering by the purchaser or third parties. Damage caused as the result of improper handling or operation, normal wear and tear, incorrect positioning or storage, improper connection or installation or Acts of God and other external influences are excluded from the terms of guarantee. In the case of complaints, we reserve the right to repair defect parts, replace them or replace the entire device. Replaced parts or devices become our property. Rights to compensation in the case of damage are excluded where there is no evidence of intent or gross negligence by the manufacturer.

If your device does show signs of a defect within the period of guarantee, please contact the sales outlet where you purchased the SWITEL device, producing the purchase receipt as evidence. All claims under the terms of guarantee in accordance with this agreement can only be asserted at the sales outlet. No claims under the terms of guarantee can be asserted after a period of two years from the date of purchase and hand-over of the product.

Index

8 Index

A

- Ambient noise, 72
- Attaching the belt clips, 64

C

- Charging the battery pack, 63
- Confirmation signal, 67
- CTCSS/DCS code, 68

D

- Declaration of Conformity, 74
- Display, 65
- Display illumination, 66
- Dual-channel monitoring, 70

E

- Energy-save mode, 64

G

- Guarantee, 75

H

- Handsfree function, 72
- Headset, 72

I

- Inserting the battery pack, 63

K

- Key lock, 71
- Key tone, 71

M

- Maintenance , 75
- Monitor function, 71

N

- Notation, 66

O

- Operating elements, 65
- Operation, 66

P

- Package contents, 62
- Preparing the walkie-talkies, 62
- Problems, 73
- Problems and solutions, 73

R

- Range, 74
- Receiving, 67
- Ringing tone, 70
- Roger Beep, 67

S

- Safety information, 60
- Searching for a channel, 69
- Selecting a channel, 67
- Service Hotline, 73
- Stopwatch, 71
- Switching off, 66
- Switching on, 66

T

- Technical data, 74
- Transmitting, 67
- Troubleshooting, 73

V

- Volume control, 66
- VOX mode, 72
- VOX sensitivity, 72

Wichtiger Hinweis

Ihr Gerät ist mit einem energieeffizienten Schaltnetzteil (Input 230 V_{AC}, Output 9 V_{DC}, 300 mA) ausgestattet. Die Nulllast beträgt ca. 0,07 W. Die durchschnittliche Effizienz beträgt ca. 70 %. Die Leistungsaufnahme beträgt ca. 1,52 W.

Note importante

La station de base de votre dispositif est équipée d'une alimentation à découpage à haut rendement énergétique (entrée 230 V_{AC}, sortie 9 V_{DC}, 300 mA). Sans charge, le courant entrant s'élève à env. 0,07 W. Le rendement moyen est d'env. 70 %. La puissance absorbée de la station de base est de 1,52 W.

Avvertimento importante

La stazione base del vostro apparecchio è dotata di un circuito di alimentazione rete ad efficienza energetica (Input 230 V_{AC}, Output 9 V_{DC}, 300 mA). Il carico nullo è pari a circa 0,07 W. L'efficienza media è pari a circa il 70 %. L'assorbimento di potenza dalla stazione di base ammonta a 1,52 W.

Important note

Your device is supplied with an energy-efficient switching power supply (Input 230 V_{AC}, Output 9 V_{DC}, 300 mA). The adaptor input power without load is approx. 0.07 W. The average efficiency is approx. 70 %. The electrical consumption is approx. 1.52 W.

SWITEL

Declaration of Conformity



Diese Anlage entspricht der europäischen R&TTE Richtlinie.
Für die komplette Konformitätserklärung nutzen Sie bitte den kostenlosen
Download von unserer Website www.switel.com.

Cet équipement est conforme à la directive européenne R&TTE.
Pour obtenir la déclaration de conformité intégrale, veuillez vous servir du
téléchargement gratuit de notre site Internet www.switel.com.

Quest'apparecchiatura è conforme alla direttiva europea R&TTE.
Per la dichiarazione di conformità completa si prega di voler usufruire del
servizio gratuito di download dal nostro sito Internet www.switel.com.

This equipment complies with the European R&TTE directive.
To view the complete Declaration of Conformity, please refer to the free
download available at our web site: www.switel.com.

Service Hotline

Bei technischen Problemen können Sie sich an unsere Service-Hotline
unter Tel. 0900 00 1675 innerhalb der Schweiz (Kosten Swisscom bei
Drucklegung: CHF 2.60/min) wenden.

S'il s'agit de problèmes techniques, vous pouvez vous adresser à notre
hotline de service en Suisse en appelant le numéro 0900 00 1675 (frais
Swisscom à la date d'impression de ce manuel : CHF 2.60/min).

In caso di problemi tecnici è possibile rivolgersi alla nostra hotline di assi-
stenza tecnica chiamando al numero 0900 00 1675 valido per la Svizzera
(spese da rete Swisscom alla data di stampa: CHF 2.60 / min).

In the event of technical problems, you can contact our hotline service,
Tel. 0900 00 1675 within Switzerland (cost via Swisscom at time of going
to print: CHF 2.60/min).