

# **SWITEL**

**COMMUNICATION PRODUCTS**

## **WTC 67x**



**Bedienungsanleitung**  
**Mode d'emploi**  
**Istruzioni per l'uso**  
**Operating Instructions**

**D**

**F**

**I**

**GB**

# ***SWITEL***

Bedienungsanleitung . . . . .	3
Mode d'emploi . . . . .	12
Istruzioni per l'uso . . . . .	21
Operating Instructions . . . . .	30
Declaration of Conformity . . . . .	40

## 1 Sicherheitshinweise

Lesen Sie diese Bedienungsanleitung sorgfältig durch.

### Bestimmungsgemäße Verwendung

Diese Funkgeräte sind geeignet für die Kommunikation mit anderen Funkgeräten gleichen Standards. Jede andere Verwendung gilt als nicht bestimmungsgemäß. Eigenmächtige Veränderungen oder Umbauten sind nicht zulässig. Öffnen Sie die Geräte in keinem Fall selbst und führen Sie keine eigenen Reparaturversuche durch.

### Verwendungsbereich

Vermeiden Sie Belastungen durch Rauch, Staub, Erschütterungen, Chemikalien, Feuchtigkeit, Hitze oder direkte Sonneneinstrahlung. Verwenden Sie die Funkgeräte nicht in explosionsgefährdeten Bereichen.

### Netzteil



**Achtung:** Verwenden Sie nur das mitgelieferte Steckernetzteil mit der Nr. CSD0750200G, da andere Netzteile die Funkgeräte zerstören können. Sie dürfen den Zugang zum Steckernetzteil nicht durch Möbel oder andere Gegenstände versperren.

### Aufladbare Akkus



**Achtung:** Werfen Sie Akkus nicht ins Feuer. Verwenden Sie nur Akkus des gleichen Typs! Achten Sie auf die richtige Polung! Bei verkehrter Polung der Akkus besteht beim Aufladen Explosionsgefahr.

### Medizinische Geräte



**Achtung:** Benutzen Sie die Funkgeräte nicht in der Nähe von medizinischen Geräten. Eine Beeinflussung kann nicht völlig ausgeschlossen werden. Funkgeräte können in Hörgeräten einen unangenehmen Brummtönen verursachen.

### Entsorgung

Wollen Sie Ihr Gerät entsorgen, bringen Sie es zur Sammelstelle Ihres kommunalen Entsorgungsträgers (z. B. Wertstoffhof). Das nebenstehende Symbol bedeutet, dass Sie das Gerät auf keinen Fall in den Hausmüll werfen dürfen! Nach dem Elektro- und Elektronikgerätegesetz sind Besitzer von Altgeräten gesetzlich gehalten, alte **Elektro- und Elektronikgeräte** einer getrennten Abfallerfassung zuzuführen.

**Akkus** entsorgen Sie beim batterievertreibenden Handel sowie bei zuständigen Sammelstellen, die entsprechende Behälter bereitstellen.

**Verpackungsmaterialien** entsorgen Sie entsprechend den lokalen Vorschriften.

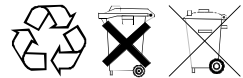

## 2 Funkgeräte in Betrieb nehmen

### Sicherheitshinweise



**Achtung:** Lesen Sie vor der Inbetriebnahme unbedingt die Sicherheitshinweise in Kapitel 1.

D

### Verpackungsinhalt prüfen

	WTC670	WTC673
Funkgeräte:	2	3
Netzteile:	1	1
Akkus:	6	9

	WTC670	WTC673
Gürtelclips:	2	3
Bedienungsanleitungen:	1	1

# Funkgeräte in Betrieb nehmen

## Akkus einlegen

Öffnen Sie das Akkufach. Legen Sie die Akkus in das geöffnete Akkufach ein. Verwenden Sie nur Akkus des Typs 1,2 V AAA NiMH. Achten Sie auf die richtige Polung! Schließen Sie das Akkufach.



Entfernen Sie gegebenenfalls vorher den Gürtelclip → Seite 5.

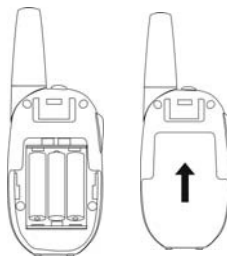

## Funkgeräte direkt aufladen

Schließen Sie das Netzteil an die Headset-/Ladebuchse des Funkgeräts an. Verwenden Sie aus Sicherheitsgründen nur das mitgelieferte Netzteil.



Laden Sie die Funkgeräte vor der ersten Inbetriebnahme für mindestens 10 Stunden. Verwenden Sie die Funkgeräte nicht während des Aufladens.

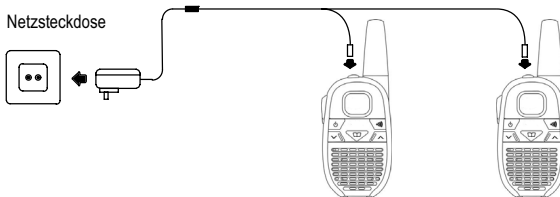

D

Der aktuelle **Akkuladezustand** wird im Display angezeigt:

voll



leer



Gerät geht aus



Sobald die Anzeige im Display blinkt und drei Warntöne zu hören sind, muss das Funkgerät aufgeladen werden.

## Gürtelclip anbringen / entfernen

Schieben Sie den Gürtelclip von oben in die Führung, bis er hörbar einrastet. Um den Gürtelclip wieder zu entfernen, heben Sie die Befestigungslasche mit dem Fingernagel etwas an und schieben den Gürtelclip nach oben.

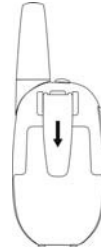

## Energiesparmodus

Ihr Funkgerät ist mit einem Energiesparmodus ausgestattet, um die Lebensdauer Ihrer Batterien zu verlängern. Wenn Sie 4 Sekunden lang keine Taste am Funkgerät drücken, wird der Energiesparmodus eingeschaltet. Sobald Sie eine Taste drücken oder ein Signal empfangen, wird der Energiesparmodus ausgeschaltet.

## 3 Bedienelemente

Die Merkmale und Funktionen Ihres Funkgeräts sind in den untenstehenden Abbildungen dargestellt.

### Funkgerät

- 1 Headset-/Ladebuchse
- 2 Antenne
- 3 Display
- 4 Rufton senden
- 5 Lautstärke + / Einstellung aufwärts
- 6 Mikrofon
- 7 Lautstärke - / Einstellung abwärts
- 8 Gerät Ein / Aus
- 9 Menü / Tastensperre
- 10 PTT-Taste

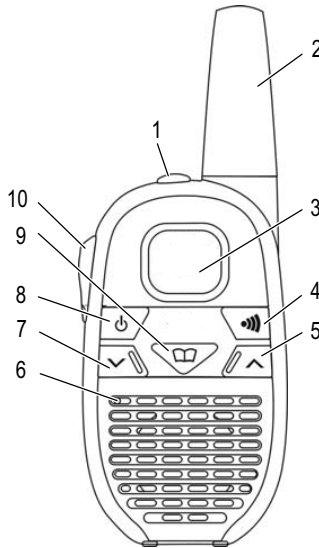

# Wie bediene ich meine Funkgeräte?

## Display

- 1 Kanalsuche
- 2 Tastensperre aktiviert
- 3 CTCSS Code
- 4 Antenne und Empfangssignalindikator
- 5 Lautstärkeeinstellung
- 6 Akkukapazität
- 7 Monitor-Funktion
- 8 VOX-Mode
- 9 Kanal

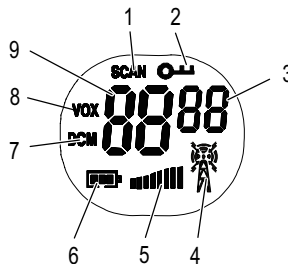

## 4 Wie bediene ich meine Funkgeräte?

### Darstellungsweise in der Bedienungsanleitung

	Abgebildete Taste drücken
	Abgebildete Taste gedrückt halten
	Abgebildete Taste loslassen
	Displayanzeige
	In das Mikrofon sprechen

### Funkgeräte ein-/ausschalten

	Funkgerät einschalten
	Die Displaybeleuchtung geht kurz an und ein Signalton ist zu hören. Anschließend werden alle zur Verfügung stehenden Displaysymbole kurz angezeigt, "ON" erscheint und dann der zuletzt eingestellte Kanal.
	Funkgerät ausschalten
	Die Displaybeleuchtung geht kurz an. "OF" erscheint und ein Signalton ist zu hören.
	Sollten Sie das Funkgerät längere Zeit nicht benutzen, empfehlen wir die Akkus zu entnehmen.





### Lautstärkeregelung

	lauter oder leiser (7 Stufen)
	Im Display zeigt die Anzahl der senkrechten Striche die eingestellte Lautstärke an.

# Wie bediene ich meine Funkgeräte?

## Senden und Empfangen

### Senden

Wenn Sie die Taste  gedrückt halten, wird das Displaysymbol  angezeigt. Beim Loslassen der Taste  ertönt ein Signalton, siehe auch  Seite 9.



Senden



Halten Sie das Funkgerät ca. 5 bis 7 cm vom Mund entfernt und sprechen Sie mit normaler Lautstärke. Um mit anderen Teilnehmern zu sprechen, müssen alle Funkgeräte auf den gleichen Kanal eingestellt sein.

### Empfangen

Sobald das Gerät eingeschaltet ist, ist es empfangsbereit. Wenn Sie ein Funksignal empfangen, wird das Displaysymbol  angezeigt.



Empfangen



Sie können keine Funksignale empfangen, wenn Sie die Taste  gedrückt halten.

## Kanalwahl

PMR446 (Private Mobil Radio) Funkgeräte können überall in Europa anmelde- und gebührenfrei benutzt werden. Es sind 8 Funkkanäle im Frequenzbereich von 446.000 MHz bis 446.100 MHz freigegeben.



Kanal auswählen und bestätigen



Jeder Vorgang wird automatisch abgebrochen, wenn innerhalb von 5 Sekunden keine Einstellung erfolgt.

Kanal	Frequenz (MHz)	Kanal	Frequenz (MHz)
1	446.00625	5	446.05625
2	446.01875	6	446.06875
3	446.03125	7	446.08125
4	446.04375	8	446.09375

## CTCSS<sup>1</sup> (Rufcodierungen) wählen

Es stehen 38 analoge (CTCSS 1 - 38) Codierungen je Kanal zur Verfügung. Funkteilnehmer können nur miteinander kommunizieren, wenn Funkkanal und Rufcodierung an den Geräten übereinstimmen.



Die Rufcodierung wird als nicht hörbares Signal mit der normalen Sprachnachricht mitgesendet. Bei dem Empfänger wird die Sprache nur dann auf den Lautsprecher übertragen, wenn der eingestellte Kanal und die Rufcodierung mit den empfangenen Daten (Einstellungen vom Sender) identisch sind. Sollte zufälligerweise auf demselben Kanal ein anderer Teilnehmer dieselbe Rufcodierung verwenden, wechseln Sie bitte mit Ihrem Gesprächspartner auf einen freien Kanal.



Einstellungsmodus CTCSS-Code aktivieren



Rufcodierung auswählen und bestätigen

<sup>1</sup> CTCSS: Continous Tone Coded Squelch System = Selektivruf

# Wie bediene ich meine Funkgeräte?

## Kanalsuche

In einer Endlosschleife wird auf den acht Kanälen nach Signalen gesucht. Im Display wird "SCAN" angezeigt. Wird ein aktiver Kanal gefunden, stoppt die Kanalsuche. Drücken Sie die Taste , um am Funkverkehr teilzunehmen.

### Kanalsuche starten / beenden



Kanalsuche starten



Kanalsuche fortsetzen



Kanalsuche beenden

## Rufton senden

Der Rufton macht andere Teilnehmer darauf aufmerksam, dass Sie ein Gespräch beginnen möchten. Voraussetzung dafür ist, dass die anderen Teilnehmer den gleichen Kanal verwenden.



Rufton wird für 2 Sekunden gesendet

## Rufton wählen / ausschalten

Sie haben 5 Ruftöne zur Auswahl. Um den Rufton auszuschalten, wählen Sie die Einstellung "OF".



Einstellungsmodus aktivieren



Rufton auswählen und bestätigen

## Monitor

Die Monitor-Funktion ermöglicht es Ihnen, auf dem aktuell eingestellten Kanal nach schwachen Signalen zu suchen. Wenn Sie ein fremdes Signal empfangen, wechseln Sie auf einen freien Kanal. Kommunizieren Sie mit anderen Teilnehmern immer auf einem freien Kanal, um Störungen zu vermeiden.



Kanal abhören



Abhören beenden

## Zweikanalüberwachung

Sie haben die Möglichkeit, neben dem aktuell eingestellten Kanal mit Rufcodierung einen weiteren Kanal mit Rufcodierung zu überwachen.

### Zweikanalüberwachung aktivieren



Zweikanalüberwachung auswählen



2. Kanal auswählen und bestätigen



Rufcodierung CTCSS für den 2. Kanal auswählen und bestätigen

Auf den beiden Kanälen wird nach Signalen gesucht. Wird ein aktiver Kanal gefunden, stoppt die Zweikanalsuche. Sie wird nach fünf Sekunden fortgesetzt, nachdem kein Signal mehr auf diesem Kanal gesendet wurde.

Drücken Sie die Taste , um auf diesem Kanal am Funkverkehr teilzunehmen.

### Zweikanalüberwachung deaktivieren



Zweikanalüberwachung auswählen



Zweikanalüberwachung beenden

## Tastenton ein-/ausschalten



Einstellungsmodus aktivieren



ON / OF auswählen und bestätigen



# Wie bediene ich meine Funkgeräte?

## Tastensperre ein-/ausschalten

Die Tastensperre verhindert das ungewollte Ändern von Einstellungen. Bei eingeschalteter Tastensperre wird das Symbol  im Display angezeigt.





Tastensperre einschalten



Tastensperre ausschalten



Die Tasten ,  und  funktionieren auch bei eingeschalteter Tastensperre.

## Bestätigungston (Roger Beep)

Der Bestätigungston erklingt, wenn Sie die Taste  loslassen. Dadurch wird Ihrem Gesprächspartner signalisiert, dass Ihre Übertragung beendet ist.

## Bestätigungston ein-/ausschalten

5 x 

Einstellungsmodus aktivieren



ON / OF auswählen und bestätigen

## Displaybeleuchtung

Die Beleuchtung leuchtet für 4 Sekunden beim Betätigen jeder Taste, außer der Taste .

## VOX<sup>1</sup> (Freisprechen)

Bei dieser Funktion beginnt das Funkgerät automatisch zu senden, wenn Ihre Stimme oder ein Geräusch erkannt wird.



Wenn Sie anfangen zu sprechen, tritt eine kurze Verzögerung auf, bevor das Funkgerät sendet.

## VOX-Modus aktivieren

Beim Freisprechen im **VOX**-Modus wird über das Funkgerät gesprochen. Die Taste  muss nicht gedrückt werden, um zu senden. Bei eingeschaltetem **VOX**-Modus wird das Symbol **VOX** im Display angezeigt.

3 x 

Einstellungsmodus aktivieren



OF oder Empfindlichkeit 1, 2, 3 auswählen und bestätigen

Für den Betrieb im VOX-Modus können 3 Empfindlichkeitsstufen entsprechend der Umgebungsgeräusche gewählt werden.

1	2	3	OF
laute Umgebungsgeräusche	normale Umgebungsgeräusche	leise Umgebungsgeräusche	VOX ausgeschaltet

## Headsetanschluss

Neben der Antenne finden Sie eine Anschlussmöglichkeit für ein Headset. Verwenden Sie ein handelsübliches Headset ohne PTT-Taste mit einem 3-poligen 2,5 mm Klinkenstecker. Eine Funktionsgarantie kann nicht übernommen werden.

D

<sup>1</sup> **VOX**: Voice Operated Transmission = Geräuscherkennung

# Falls es Probleme gibt

## 5 Falls es Probleme gibt

Haben Sie Probleme mit Ihrem Funkgerät, kontrollieren Sie zuerst die folgenden Hinweise.  
Bei technischen Problemen können Sie sich an unsere Service-Hotline unter Tel. 0900 00 1675 innerhalb der Schweiz (Kosten Swisscom bei Drucklegung: CHF 2.60/min) wenden. Bei Garantieansprüchen wenden Sie sich an Ihren Fachhändler. Die Garantiezeit beträgt 2 Jahre.

### Fragen und Antworten

Fragen	Antworten
Keine Funktion	<ul style="list-style-type: none"><li>- Funkgerät nicht geladen</li><li>- Tastensperre aktiviert</li></ul>
Senden nicht möglich	<ul style="list-style-type: none"><li>- Taste <input type="button" value="PTT"/> zum Senden gedrückt halten</li><li>- Kanal wird von anderen Teilnehmern benutzt</li></ul>
Kein Empfang	<ul style="list-style-type: none"><li>- Taste <input type="button" value="PTT"/> loslassen</li><li>- Lautstärke zu gering eingestellt</li><li>- Sie befinden sich außerhalb des Empfangsbereichs, ändern Sie Ihre Position</li><li>- Hindernisse, wie Bäume und Gebäude, haben einen negativen Einfluss auf die Reichweite</li><li>- Kanal wird von anderen Teilnehmern benutzt</li><li>- Während des Aufladens kann Ihr Funkgerät nicht senden</li><li>- Akkuladenzustand zu gering</li></ul>

## 6 Technische Eigenschaften

### Technische Daten

Merkmal	Wert
Ausgangsleistung	0,5 W
Reichweite	bis zu 4 km - bei freier Sichtlinie
Stand-by-Zeit	Bis zu 32 Std.
Max. Gesprächsdauer	Bis zu 2 Std.
Ladezeit	Min. 10 Std.
Akkus	1,2 V NiMH Akkus, 600 mAh
Stromversorgung	Eingang: 230 V, 50 Hz Ausgang: 7,5 V, 200 mA

### Konformitätserklärung

Dieses Gerät erfüllt die Anforderungen der EU-Richtlinie: 1999/5/EG Richtlinie über Funkanlagen und Telekommunikationsendeinrichtungen und die gegenseitige Anerkennung ihrer Konformität. Die Konformität mit der o. a. Richtlinie wird durch das CE-Zeichen auf dem Gerät bestätigt. Für die komplette Konformitätserklärung nutzen Sie bitte den kostenlosen Download von unserer Website [www.switel.com](http://www.switel.com).



## 7 Pflegehinweise / Garantie

### Pflegehinweise

- Reinigen Sie die Gehäuseoberflächen mit einem weichen und fusselfreien Tuch.
- Verwenden Sie keine Reinigungsmittel oder Lösungsmittel.

### Garantie

SWITEL - Geräte werden nach den modernsten Produktionsverfahren hergestellt und geprüft. Ausgesuchte Materialien und hoch entwickelte Technologien sorgen für einwandfreie Funktion und lange Lebensdauer. Die Garantie gilt nicht für die in den Produkten verwendeten Batterien, Akkus oder Akkupacks. Die Garantiezeit beträgt 24 Monate, gerechnet vom Tage des Kaufs.

Innerhalb der Garantiezeit werden alle Mängel, die auf Material- oder Herstellungsfehler zurückzuführen sind, kostenlos beseitigt. Der Garantieanspruch erlischt bei Eingriffen durch den Käufer oder durch Dritte. Schäden, die durch unsachgemäße Behandlung oder Bedienung, natürliche Abnutzung, durch falsches Aufstellen oder Aufbewahren, durch unsachgemäßen Anschluss oder Installation sowie durch höhere Gewalt oder sonstige äußere Einflüsse entstehen, fallen nicht unter die Garantieleistung. Wir behalten uns vor, bei Reklamationen die defekten Teile auszubessern, zu ersetzen oder das Gerät auszutauschen. Ausgetauschte Teile oder ausgetauschte Geräte gehen in unser Eigentum über. Schadenersatzansprüche sind ausgeschlossen, soweit sie nicht auf Vorsatz oder grober Fahrlässigkeit des Herstellers beruhen.

Sollte Ihr Gerät dennoch einen Defekt innerhalb der Garantiezeit aufweisen, wenden Sie sich bitte unter Vorlage Ihrer Kaufquittung ausschließlich an das Geschäft, in dem Sie Ihr SWITEL - Gerät gekauft haben. Alle Gewährleistungsansprüche nach diesen Bestimmungen sind ausschließlich gegenüber Ihrem Fachhändler geltend zu machen. Nach Ablauf von zwei Jahren nach Kauf und Übergabe unserer Produkte können Gewährleistungsrechte nicht mehr geltend gemacht werden.

# Consignes de sécurité

## 1 Consignes de sécurité

Lisez très attentivement ce mode d'emploi.

### Utilisation conforme aux prescriptions

Ces émetteurs-récepteurs conviennent pour la communication avec d'autres émetteurs-récepteurs de même standard. Toute autre utilisation est considérée comme non conforme à l'usage. Des modifications ou changements effectués d'un propre gré ne sont pas autorisés. N'ouvrez en aucun cas les appareils et n'effectuez aucun essai de réparation vous-même.

### Zone d'utilisation

Évitez toute nuisance par la fumée, la poussière, les tremblements, les produits chimiques, l'humidité, la grande chaleur ou l'ensoleillement direct. Ne vous servez pas des émetteurs-récepteurs dans des endroits exposés aux explosions.

### Bloc secteur



**Attention** : N'utilisez que le bloc secteur ayant le n° CSD0750200G, d'autres blocs secteur pouvant détruire les émetteurs-récepteurs. Vous ne devez pas bloquer son accès par des meubles ou d'autres objets.

### Piles rechargeables



**Attention** : Ne jetez pas les piles dans le feu. N'utilisez que des piles du même type ! Observez une polarisation correcte ! Risque d'explosion lors de leur chargement si la polarisation est incorrecte.

### Appareils médicaux



**Attention** : N'utilisez pas ces émetteurs-récepteurs à proximité d'appareils médicaux, leur influence sur ceux-ci ne pouvant pas être totalement exclue. Les émetteurs-récepteurs peuvent causer un bourdonnement désagréable dans les prothèses auditives.

### Élimination

Si vous ne voulez plus vous servir de votre appareil, veuillez l'apporter au centre de collecte de l'organisme d'élimination des déchets de votre commune (par ex. centre de recyclage). L'icône ci-contre signifie que vous ne devez en aucun cas jeter vos appareils dans les ordures ménagères ! D'après la loi relative aux appareils électriques et électroniques, les propriétaires d'appareils usagés sont tenus de mettre tous ce genre d'**appareils** dans un collecteur séparé. Éliminez les **piles rechargeables** auprès d'un revendeur spécialisé ainsi que dans des centres de collecte qui tiennent à votre disposition les collecteurs appropriés.

Éliminez les **fournitures d'emballage** conformément aux prescriptions locales.



## 2 Mettre les émetteurs-récepteurs en service

### Consignes de sécurité



**Attention** : Avant de mettre votre appareil en service, lisez impérativement les consignes de sécurité mentionnées au chapitre 1.

### Contrôler le contenu de l'emballage

	WTC670	WTC673
Émetteurs-récepteurs :	2	3
Bloc secteur :	1	1
Piles rechargeables :	6	9

	WTC670	WTC673
Clips de ceinture :	2	3
Mode d'emploi :	1	1

# Mettre les émetteurs-récepteurs en service

## Placer les piles rechargeables

Ouvrez le compartiment à piles. Placez les piles rechargeables dans le compartiment ouvert. N'utilisez que des piles rechargeables de type 1,2 V AAA NiMH. Observez la polarisation correcte ! Fermez le compartiment à piles.



Le cas échéant, enlevez auparavant le clip de ceinture → page 14.

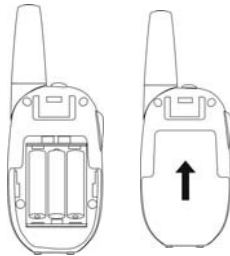

## Charger directement les émetteurs-récepteurs

Raccordez le bloc secteur à la prise de l'oreillette/de charge de l'émetteur-récepteur. Pour des raisons de sécurité, n'utilisez que le bloc secteur fourni avec l'appareil.



Avant la première mise en service, chargez les émetteurs-récepteurs pendant un minimum de 10 heures. Ne les utilisez pas pendant le chargement.

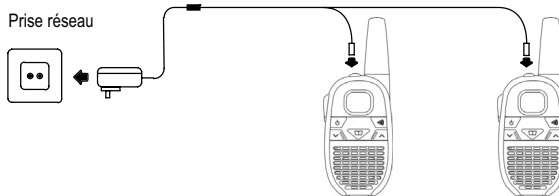

Le niveau actuel **de charge des piles** est affiché sur l'écran :

Plein



Vide



L'appareil s'éteint



Dès que l'affichage clignote à l'écran et que trois signaux sonores d'avertissement se font entendre, l'émetteur-récepteur doit être rechargé.

# Éléments de manipulation

## Fixer / Retirer le clip de ceinture

Introduisez le clip de ceinture par le haut dans le guidage jusqu'à ce qu'il s'enclenche. Pour le retirer, soulevez légèrement la languette de fixation avec l'ongle et poussez le clip vers le haut.



## Mode économie d'énergie

Votre émetteur-récepteur est équipé d'un mode économie d'énergie afin de prolonger la durée de vie de vos piles. Si vous n'actionnez aucune touche de l'émetteur-récepteur pendant 4 secondes, le mode économie d'énergie s'active. Dès que vous appuyez sur une touche ou que vous recevez un signal, le mode économie d'énergie se désactive.

## 3 Éléments de manipulation

Les caractéristiques et les fonctions de votre émetteur-récepteur sont représentées par les illustrations ci-dessous.

### Émetteur-récepteur

- 1 Prise oreillette/de charge
- 2 Antenne
- 3 Écran
- 4 Émission de la sonnerie
- 5 Réglage du volume sonore + / augmenter
- 6 Microphone
- 7 Réglage du volume sonore - / diminuer
- 8 Appareil allumé / éteint
- 9 Menu / Verrouillage des touches
- 10 Touche PTT

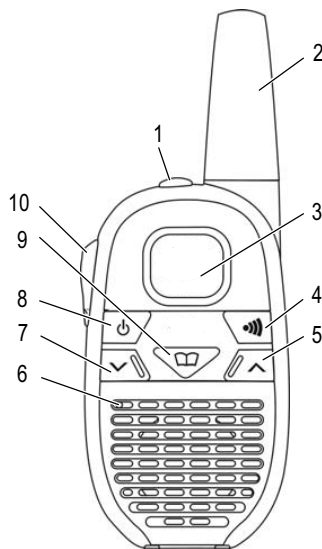

# Comment vous servir de vos émetteurs-récepteurs ?

## Écran

- 1 Recherche du canal
- 2 Le verrouillage des touches est activé
- 3 Code CTCSS
- 4 Antenne et indicateur de signal de réception
- 5 Réglage du volume sonore
- 6 Capacité des piles rechargeables
- 7 Fonction de l'écran
- 8 Mode VOX
- 9 Canal

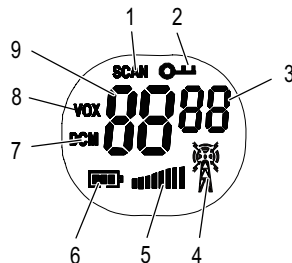

## 4 Comment vous servir de vos émetteurs-récepteurs ?

### Mode de représentation dans le mode d'emploi

	Appuyer sur la touche représentée
	Maintenir appuyée la touche représentée
	Relâcher la touche représentée
	Affichage
	Parler dans le microphone

### Allumer / Éteindre les émetteurs-récepteurs

	Allumer l'émetteur-récepteur
	L'éclairage de l'écran s'allume brièvement et un signal sonore se fait entendre. Ensuite toutes les icônes disponibles sont affichées brièvement sur l'écran, "ON" s'affiche et puis le canal réglé en dernier.
	Éteindre l'émetteur-récepteur
	L'éclairage de l'écran s'allume brièvement. "OF" s'affiche et un signal sonore se fait entendre.
	Si vous devez ne pas utiliser l'émetteur-récepteur pendant une période prolongée, nous vous recommandons de retirer le pack de piles rechargeables.





### Réglage du volume sonore

	Plus fort ou moins fort (7 sensibilités)
	Sur l'écran, le nombre de traits verticaux indique le réglage du volume sonore.

# Comment vous servir de vos émetteurs-récepteurs ?

## Emission et réception

### Émission

Si vous appuyez sur la touche , l'icône  s'affiche. Si vous relâchez la touche  un signal sonore se fait entendre, voir également  page 18.

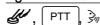

Émettre



Tenez l'émetteur-récepteur à environ 5 à 7 cm de votre bouche et parlez avec un volume sonore normal. Pour parler avec d'autres correspondants, tous les appareils doivent être réglés sur le même canal.

### Recevoir

Dès que l'appareil est branché, il est prêt à recevoir. Si vous recevez un signal radio, l'icône écran  s'affiche.



Recevoir



Vous ne pouvez pas recevoir de signaux radio si vous maintenez appuyée la touche .

## Choix du canal

PMR446 (Private Mobil Radio) Les émetteurs-récepteurs peuvent être utilisés partout en Europe sans être déclarés et sont exonérés de taxes. 8 canaux radio sont validés dans une gamme de fréquences de 446.000 MHz à 446.100 MHz.



Sélectionner le canal et confirmer



Chaque opération est automatiquement interrompue si vous n'effectuez pas de réglage dans les 5 secondes.

Canal	Fréquence (MHz)	Canal	Fréquence (MHz)
1	446.00625	5	446.05625
2	446.01875	6	446.06875
3	446.03125	7	446.08125
4	446.04375	8	446.09375

## Sélectionner le CTCSS<sup>1</sup> (codes d'appel)

38 codifications analogiques (CTCSS 1 - 38) sont disponibles par canal. Les utilisateurs radio ne peuvent communiquer les uns avec les autres que si le canal radio et le code d'appel des appareils concordent.



Le code d'appel est envoyé avec le message vocal normal sous la forme d'un signal inaudible. Chez le récepteur, la langue n'est transmise au haut-parleur que si le canal paramétré et le code d'appel sont identiques aux données reçues (paramétrages de l'émetteur). Si, par hasard, un autre correspondant utilisait le même code d'appel sur le même canal, veuillez passer avec votre correspondant sur un canal libre.



Activer le mode de réglage du code CTCSS



Sélectionner le code d'appel et confirmer

<sup>1</sup> CTCSS: Continous Tone Coded Squelch System = Appel sélectif



# Comment vous servir de vos émetteurs-récepteurs ?

## Recherche de canal

Dans une boucle infinie, l'appareil cherche des signaux sur les huit canaux. "SCAN" s'affiche à l'écran. Si un canal actif est trouvé, la recherche du canal s'arrête. Appuyez sur la touche  pour participer au contact radio.

### Début / fin de la recherche de canal



Démarrer la recherche de canal



Continuer la recherche de canal



Terminer la recherche de canal

## Emission d'une sonnerie

La sonnerie fait remarquer à d'autres correspondants que vous désirez entamer une conversation. À condition toutefois que les autres correspondants utilisent le même canal.



La sonnerie est émise pendant 2 secondes

## Sélection / désactivation de la sonnerie

Vous avez 5 sonneries à votre disposition. Pour débrancher la sonnerie, sélectionnez le réglage "OF".



Activer le mode de réglage



Sélectionner la sonnerie et confirmer

## Écran

La fonction Écran vous permet de chercher des signaux faibles sur le canal actuellement paramétré. Si vous recevez un signal étranger, passez sur un canal libre. Communiquez toujours avec d'autres correspondants sur un canal libre pour éviter les perturbations.



Ecouter le canal



Terminer l'écoute

## Surveillance de deux canaux

Vous avez la possibilité, en plus du canal actuellement réglé avec un code d'appel, de surveiller un autre canal avec un code d'appel.

### Activer la surveillance de deux canaux



Sélectionner la surveillance de deux canaux



Sélectionner le 2ème canal et confirmer



Sélectionner le code d'appel CTCSS pour le 2ème canal et confirmer

La recherche de signaux se fait sur les deux canaux. Si un canal actif est trouvé, la recherche des deux canaux s'arrête. La recherche de canal se poursuit cinq secondes après que plus aucun signal n'a été émis sur ce canal.

Appuyez sur la touche  pour participer au contact radio sur ce canal.

### Désactiver la surveillance de deux canaux



Sélectionner la surveillance de deux canaux



Terminer la surveillance de deux canaux

## Son des touches Activer / Désactiver



Activer le mode de réglage



Sélectionner ON / OF et confirmer

# Comment vous servir de vos émetteurs-récepteurs ?

## Activer / Désactiver le verrouillage des touches

Le verrouillage des touches empêche la modification involontaire des paramétrages. Si le verrouillage des touches est activé, l'icône  apparaît à l'écran.





Activer le verrouillage des touches



Désactiver le verrouillage des touches



Les touches ,  et  fonctionnent, même si le verrouillage des touches est activé.

## Signal de confirmation (Roger Beep)

Le signal de confirmation retentit si vous relâchez la touche . Cela signale à votre correspondant que votre transmission est terminée.

## Activer / désactiver le signal de confirmation



Activer le mode de réglage



Sélectionner ON / OF et confirmer

## Éclairage de l'écran

L'éclairage s'allume pendant 4 secondes si vous appuyez sur chaque touche sauf sur la touche .

## VOX<sup>1</sup> (Mode mains-libres)

Avec cette fonction, l'émetteur-récepteur commence à émettre automatiquement quand votre voix ou un bruit est détecté.



Quand vous commencez à parler, l'émetteur-récepteur émet avec un léger retard.

## Activer le mode VOX (mains libres)

En parlant mains-libres en mode **VOX**, vous parlez via l'émetteur-récepteur. Vous n'avez pas besoin d'appuyer sur la touche  pour émettre. Lorsque le mode **VOX** est activé, le symbole **VOX** est affiché.



Activer le mode de réglage



Sélectionner OF ou la sensibilité 1, 2, 3 et confirmer

Pour le fonctionnement en mode VOX, vous pouvez sélectionner 3 niveaux de sensibilité en fonction des bruits ambiants.

1	2	3	0
Bruits ambiants forts	Bruits ambiants normaux	Bruits ambiants faibles	VOX éteint

## Raccord oreillette

À côté de l'antenne se trouve une possibilité de raccorder l'oreillette. Utilisez une oreillette disponible dans le commerce sans touche PTT avec une fiche à jack tripolaire 2,5 mm. Une garantie de fonction ne peut être prise en charge.

<sup>1</sup> **VOX** : Voice Operated Transmission = Détection de bruits

## 5 En cas de problèmes

Si vous avez des problèmes avec votre émetteur-récepteur, contrôlez d'abord les points suivants.

S'il s'agit de problèmes techniques, vous pouvez vous adresser à notre hotline de service en Suisse en appelant le numéro 0900 00 1675 (frais Swisscom à la date d'impression de ce manuel : CHF 2.60/min). Si vous avez des droits de garantie, adressez-vous à votre revendeur. La durée de la garantie est de 2 ans.

### Questions et réponses

Questions	Réponses
Pas de fonction	<ul style="list-style-type: none"><li>- L'émetteur-récepteur n'est pas chargé</li><li>- Le verrouillage des touches est activé</li></ul>
Émission pas possible	<ul style="list-style-type: none"><li>- Maintenir la touche <b>PTT</b> appuyée pour émettre</li><li>- Le canal est utilisé par d'autres correspondants</li></ul>
Pas de réception	<ul style="list-style-type: none"><li>- Relâcher la touche <b>PTT</b></li><li>- Le volume sonore est réglé trop faiblement</li><li>- Vous vous trouvez en dehors de la zone desservie, modifiez votre position</li><li>- Des obstacles, comme des arbres et des bâtiments, exercent une influence négative sur la portée</li><li>- Le canal est utilisé par d'autres correspondants</li><li>- Votre émetteur-récepteur ne peut pas émettre pendant le chargement.</li><li>- Le niveau de charge des piles est trop faible</li></ul>

## 6 Caractéristiques techniques

### Données techniques

Caractéristique	Valeur
Puissance de sortie	0,5 W
Portée	jusqu'à 4 km - si ligne visuelle libre
Autonomie en veille	Jusqu'à 32 h
Durée max. de communication	Jusqu'à 2 h
Temps de charge	Min. 10 h
Piles rechargeables	1,2 V NIMH pile rechargeable, 600 mAh
Alimentation en courant	Entrée : 230 V, 50 Hz Sortie 7,5 V, 200 mA

### Déclaration de conformité

Cet appareil répond aux exigences des directives de l'union européenne (UE) :

Directive 1999/5/CE sur les installations de radio et de télécommunication et la reconnaissance réciproque de leur conformité. La conformité avec la directive mentionnée ci-dessus est confirmée par le symbole CE placé sur l'appareil.

Pour obtenir la déclaration de conformité intégrale, veuillez vous servir du téléchargement gratuit de notre site Internet [www.switel.com](http://www.switel.com).



# Remarques d'entretien / Garantie

---

## 7 Remarques d'entretien / Garantie

### Remarques d'entretien

- Nettoyez les surfaces du boîtier avec un chiffon doux et non pelucheux.
- N'utilisez pas de produits d'entretien ou de solvants.

### Garantie

Les appareils SWITEL sont fabriqués selon les procédés les plus modernes et sont contrôlés. Des matériaux sélectionnés et des technologies de pointe ont pour effet un fonctionnement irréprochable et une longue durée de vie. La garantie n'est pas valable pour les piles, les piles rechargeables ou les packs de piles rechargeables utilisés dans les produits. La durée de la garantie est de 24 mois, à partir de la date d'achat.

Pendant la durée de la garantie, tous les défauts dus à des vices de matériel ou de fabrication seront éliminés gratuitement. Le droit à la garantie expire en cas d'intervention de l'acheteur ou de tiers. Les dommages provenant d'un maniement ou d'une manipulation incorrects, d'une usure naturelle, d'une mauvaise mise en place ou d'une mauvaise conservation, d'un raccordement ou d'une installation incorrects ainsi que d'un cas de force majeure ou autres influences extérieures sont exclus de la garantie. En cas de réclamations, nous nous réservons le droit de réparer, de remplacer les pièces défectueuses ou d'échanger l'appareil. Les composants remplacés ou les appareils échangés deviennent notre propriété. Les demandes de dommages et intérêts sont exclues tant qu'elles ne reposent pas sur l'intention ou une négligence grossière du fabricant.

Si votre appareil devait malgré tout présenter une défectuosité pendant la période de garantie, veuillez vous adresser, muni de la quittance d'achat, exclusivement au magasin où vous avez acheté votre appareil SWITEL. Tous les droits de garantie basés sur ces dispositions ne peuvent être revendiqués qu'auprès de votre revendeur. Deux ans après l'achat et la remise de nos produits, il n'est plus possible de faire valoir les droits à la garantie.

## 1 Indicazioni di sicurezza

Leggere attentamente le presenti istruzioni per l'uso.

### Impiego conforme agli usi previsti

Questi radiotrasmittitori si prestano alla comunicazione con altri apparecchi radiotrasmittitori aventi lo stesso standard. Qualsiasi altro impiego è considerato come non conforme agli usi previsti. Non sono consentite modifiche o trasformazioni non autorizzate. Non aprire per nessuna ragione gli apparecchi autonomamente ed evitare di compiere riparazioni di propria iniziativa.

### Ambito di impiego

Evitare un'esposizione a fumo, polvere, vibrazioni, sostanze chimiche, umidità, calore e raggi solari diretti. Non utilizzare i radiotrasmittitori in aree esposte al rischio di deflagrazione.

### Alimentatore di rete



**Attenzione:** Utilizzare soltanto l'alimentatore a spina fornito in dotazione con numero CSD0750200G visto che l'uso di altri alimentatori di rete potrebbe danneggiare i radiotrasmittitori. Non ostacolare il libero accesso all'alimentatore a spina con mobili o altri oggetti simili.

### Accumulatori ricaricabili



**Attenzione:** Non gettare gli accumulatori ricaricabili nel fuoco. Utilizzare solo accumulatori dello stesso tipo. Osservare la corretta polarità! Pericolo di esplosione durante il caricamento degli accumulatori in caso di errata polarità.

### Apparecchiature mediche



**Attenzione:** Evitare di utilizzare i radiotrasmittitori in vicinanza di apparecchiature mediche. Non è infatti possibile escludere il rischio di possibili interferenze. Radiotrasmittitori possono causare un fastidioso ronzio in apparecchi acustici.

### Smaltimento

Procedere allo smaltimento dell'apparecchio esaurito consegnandolo presso uno dei punti di raccolta istituiti dalla propria società di smaltimento rifiuti comunale (ad es. centro di riciclo materiali). Il simbolo riportato qui a lato indica che non è assolutamente consentito smaltire l'apparecchio assieme ai normali rifiuti domestici! Secondo quanto previsto dalla legge sugli apparecchi elettrici ed elettronici, i proprietari di apparecchi esauriti sono per legge tenuti alla consegna di tutti gli **apparecchi elettrici ed elettronici** presso un centro di rilievo rifiuti in raccolta differenziata.

**Consegnare gli accumulatori** per lo smaltimento presso rivenditori al dettaglio di batterie o centri di raccolta che mettono a disposizione appositi contenitori.

Smaltire **confezioni ed imballaggi** in base a quanto indicato dalle norme in vigore a livello locale.



## 2 Mettere in funzione i radiotrasmittitori

### Indicazioni di sicurezza



**Attenzione:** Prima della messa in funzione, leggere attentamente le indicazioni di sicurezza riportate al capitolo 1.

### Verificare il contenuto della confezione

	WTC670	WTC673
Radiotrasmittitori:	2	3
Alimentatore di rete:	1	1
Accumulatori:	6	9

	WTC670	WTC673
Ganci per cintura:	2	3
Manuale di istruzioni per l'uso:	1	1

# Mettere in funzione i radiotrasmittitori

## Inserire gli accumulatori

Aprire il vano accumulatori. Inserire gli accumulatori nel vano accumulatori aperto. Utilizzare unicamente accumulatori di tipo 1,2 V AAA NIMH prestando attenzione alla corretta polarità! Chiudere quindi il vano accumulatori.



Rimuovere prima se necessario il gancio per cintura  pagina 23.

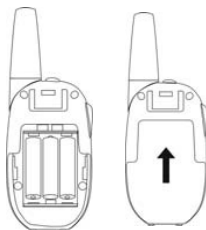

## Diretta ricarica dei radiotrasmittitori

Collegare l'alimentatore di rete alla presa dell'auricolare/di carica del radiotrasmittitore. Per motivi di sicurezza si prega di utilizzare soltanto l'alimentatore di rete fornito in dotazione.



Caricare i radiotrasmittitori prima della messa in funzione per minimo 10 ore. Evitare l'uso dei radiotrasmittitori in fase di carica.

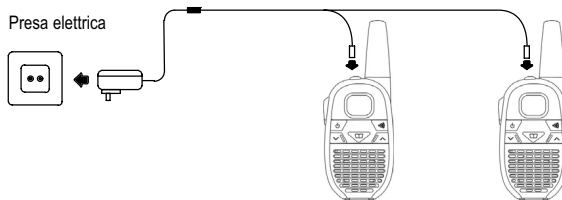

Lo **stato di carica** attuale è visualizzato sul display:

Carico



Scarico



Apparecchio si spegne



Non appena l'indicazione sul display lampeggia e si avvertono tre suoni di avviso è necessario provvedere alla ricarica del radiotrasmittitore.

## Applicare / Rimuovere il gancio per cintura

Introdurre il gancio per cintura dall'alto nella guida fino a farlo scattare in posizione. Per rimuovere nuovamente il gancio per cintura, sollevare leggermente la linguetta di fissaggio con l'unghia del dito spingendo il gancio per cintura verso sopra.

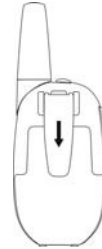

## Modo di risparmio energetico

Il radiotrasmittitore è dotato di modo di risparmio energetico allo scopo di prolungare la durata in vita delle batterie impiegate all'interno del dispositivo. Non premendo per oltre 4 secondi alcun tasto sul radiotrasmittitore, l'apparecchio passa al modo di risparmio energetico. Premendo invece un tasto o se si riceve un segnale, il modo di risparmio energetico è di nuovo disattivato.

## 3 Elementi di comando

Le caratteristiche e funzioni del radiotrasmittitore sono raffigurate qui di seguito.

### Radiotrasmittitore

- 1 Presa per auricolare/di carica
- 2 Antenna
- 3 Display
- 4 Invio segnale di chiamata
- 5 Volume + / Impostazione verso sopra
- 6 Microfono
- 7 Volume - / Impostazione verso sotto
- 8 Apparecchio ON / OFF
- 9 Menu / Blocco tastiera
- 10 Tasto PTT

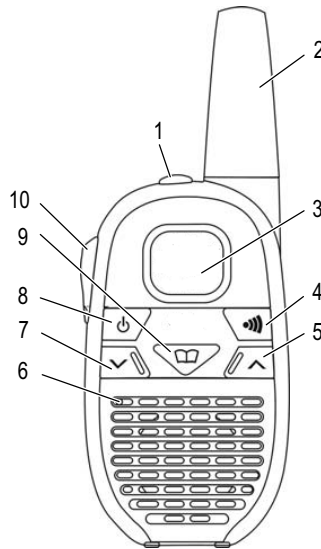

# Come funzionano i miei radiotrasmittitori?

## Display

- 1 Funzione ricerca di canale
- 2 Blocco tastiera attivato
- 3 Codice CTCSS
- 4 Antenna e indicatore del segnale di ricezione
- 5 Regolazione del volume
- 6 Capacità di carica dell'accumulatore
- 7 Funzione schermo
- 8 Modalità VOX
- 9 Canale

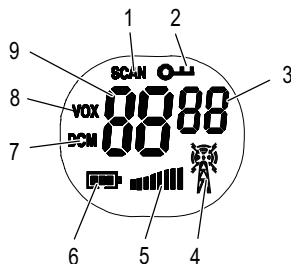

## 4 Come funzionano i miei radiotrasmittitori?

### Modi di rappresentazione nelle istruzioni per l'uso

	Premere il tasto raffigurato
	Tenere premuto il tasto raffigurato
	Rilasciare il tasto raffigurato
	Visualizzazione di display
	Parlare rivolti verso il microfono

### Attivare / Disattivare i radiotrasmittitori

	Inserire il radiotrasmittitore
	La retroilluminazione del display si accende brevemente e si avverte un segnale acustico. Tutti i simboli di display disponibili sono quindi brevemente visualizzati, sul display appare "ON" mentre l'apparecchio passa al canale impostato per ultimo.
	Disinserire il radiotrasmittitore
	La retroilluminazione del display si accende brevemente. Sul display appare "OF" e si avverte un segnale acustico.
	Nel caso di mancato utilizzo del radiotrasmittitore per un periodo prolungato, si consiglia di rimuovere gli accumulatori.

### Regolazione del volume





	Volume più alto o più basso (7 livelli)
	Una serie di sbarre verticali visualizzate sul display indicano il livello di volume impostato.



# Come funzionano i miei radiotrasmittitori?

## Trasmettere e ricevere

### Trasmettere

Tenendo premuto il tasto , il simbolo di display  è visualizzato. Rilasciando il tasto  si avverte un segnale acustico, vedi anche  pagina 27.





Trasmettere



Mantenere con il radiotrasmittitore una distanza di ca. 5 - 7 cm dalla bocca e parlare con voce normale. Per poter comunicare con altri interlocutori, tutti i radiotrasmittitori devono essere impostati sullo stesso canale.

### Ricevere

Una volta inserito il radiotrasmittitore, l'apparecchio è subito pronto al funzionamento. Non appena si riceve un segnale radio, sul display appare il simbolo .





Ricevere



Non è possibile ricevere alcun segnale radio se si tiene premuto il tasto .

## Selezione del canale

Radiotrasmittitori PMR446 (Private Mobil Radio) possono essere utilizzati ovunque in Europa gratuitamente e senza bisogno di precedente registrazione. Il campo di frequenza disponibile include 8 canali radio compresi tra 446.000 MHz e 446.100 MHz.





Selezionare il canale e confermare



Ogni singolo processo si interrompe automaticamente se entro 5 secondi non si procede con l'immissione di un'impostazione.

Canale	Frequenza (MHz)	Canale	Frequenza (MHz)
1	446.00625	5	446.05625
2	446.01875	6	446.06875
3	446.03125	7	446.08125
4	446.04375	8	446.09375

## Selezionare CTCSS<sup>1</sup> (codifica di chiamata)

Sono disponibili 38 codifiche analogiche (CTCSS 1 - 38) per ciascun canale. Gli utenti di radiotrasmittitori sono in grado di comunicare tra di loro nel momento in cui su tutti gli apparecchi risultano impostati canale radio e codifica di chiamata uguali.



La codifica di chiamata è trasmessa come segnale non udibile assieme al normale messaggio vocale. Il parlato è trasferito sull'altoparlante del ricevitore solo se canale selezionato e codifica di chiamata dei dati ricevuti/trasmessi risultano identici (impostazioni del trasmettitore). Qualora altre persone utilizzassero già per puro caso sullo stesso canale la stessa codifica di chiamata, si prega di passare su un canale libero assieme al proprio interlocutore.

2 x 

Attivare la modalità di impostazione del codice CTCSS





Selezionare la codifica di chiamata e confermare

<sup>1</sup> CTCSS: Continous Tone Coded Squelch System = Chiamata selettiva

# Come funzionano i miei radiotrasmittitori?

## Ricerca di canale

In un ciclo continuo l'apparecchio scorre gli otto canali alla presenza di segnali. Sul display è visualizzato "SCAN". Non appena è stato individuato un canale attivo, la ricerca di canale è interrotta. Premere quindi il tasto  per partecipare alla comunicazione via radio.

### Avviare / Concludere la ricerca di canale



Avviare la ricerca di canale



Proseguire la ricerca di canale



Concludere la ricerca di canale

## Trasmettere un segnale di chiamata

Il segnale di chiamata richiama l'attenzione degli altri interlocutori indicando che il chiamante desidera avviare una conversazione. A tal fine è necessario che gli altri interlocutori utilizzino lo stesso canale.



Il segnale di chiamata è trasmesso per 2 secondi

## Selezionare / Disattivare il segnale di chiamata

Sono disponibili 5 segnali di chiamata tra cui scegliere. Per disattivare il segnale di chiamata, selezionare l'impostazione "OF".

4 x

Attivare la modalità di impostazione



Selezionare il segnale di chiamata e confermare

## Monitor

La funzione schermo consente di individuare sul canale attualmente impostato la presenza di segnali deboli. In caso di ricezione di un segnale estraneo, si passa ad un canale libero. Si consiglia di comunicare con altri interlocutori sempre su un canale libero onde evitare interferenze.



Ascoltare il canale



Concludere l'ascolto

## Monitoraggio dual watch

Oltre al canale impostato con codifica di chiamata è altresì possibile sorvegliare un ulteriore canale con codifica di chiamata.

### Attivare il monitoraggio dual watch

7 x

Selezionare il monitoraggio dual watch



Selezionare il 2° canale e confermare



Selezionare la codifica di chiamata CTCSS per il 2° canale e confermare

L'apparecchio va alla ricerca di segnali sui due canali. Non appena è stato individuato un canale attivo, la ricerca dei due canali su cui sintonizzarsi è interrotta. Una volta trascorsi cinque secondi senza che il canale sia utilizzato per trasmettere, la ricerca di canale è proseguita.

Premere quindi il tasto  per partecipare alla comunicazione via radio su questo canale.

### Disattivare il monitoraggio dual watch

7 x

Selezionare il monitoraggio dual watch



Concludere il monitoraggio dual watch

## Attivare / Disattivare il tono dei tasti

6 x

Attivare la modalità di impostazione



Selezionare ON / OF e confermare

# Come funzionano i miei radiotrasmittitori?

## Attivare/Disattivare il blocco tastiera

Il blocco tastiera impedisce di compiere modifiche non intenzionali alle impostazioni. Con blocco tastiera inserito il simbolo  appare sul display.





Attivare il blocco tastiera



Disattivare il blocco tastiera



I tasti ,  e  funzionano anche con blocco tastiera attivato.

## Segnale acustico di conferma (Roger Beep)

Il segnale acustico di conferma risuona rilasciando il tasto . In tal modo al proprio partner di chiamata si segnala la conclusione della trasmissione.

## Attivare / Disattivare il segnale acustico di conferma



Attivare la modalità di impostazione



Selezionare ON / OF e confermare

## Retroilluminazione del display

La retroilluminazione si accende per 4 secondi non appena si preme un tasto qualsiasi, tranne il tasto .

## VOX<sup>1</sup> (funzione vivavoce)

Questa funzione consente al radiotrasmittitore di trasmettere automaticamente, non appena è rilevata una voce o un rumore.



Appena si inizia la conversazione subentra un breve ritardo, prima che il radiotrasmittitore proceda alla trasmissione.

## Attivare la modalità VOX

Servendosi della funzione vivavoce in modalità **VOX**, la conversazione è trasmessa attraverso il radiotrasmittitore. Il tasto  non deve essere premuto a scopo di trasmissione. Con modalità **VOX** inserita, sul display è visualizzato il simbolo **VOX**.



Attivare la modalità di impostazione



Selezionare OF o uno dei livelli di sensibilità 1, 2, 3 e confermare

Per l'esercizio in modalità VOX è possibile scegliere fra 3 livelli di sensibilità relativi alla riproduzione di rumori dell'ambiente circostante.

1	2	3	O
Elevata rumorosità dell'ambiente circostante	Normale rumorosità dell'ambiente circostante	Ridotta rumorosità dell'ambiente circostante	Modalità VOX disattivata

## Presenza di collegamento per auricolare

Oltre ad un'antenna è anche possibile collegare un auricolare. Servirsi di un comune auricolare senza tasto PTT con una spina per presa telefonica tripolare da 2,5 mm. Non si assume alcuna garanzia riguardo il rispettivo funzionamento.

<sup>1</sup> **VOX**: Voice Operated Transmission = Rilevamento rumori

# In presenza di problemi

## 5 In presenza di problemi

In presenza di problemi con il radiotrasmittitore, seguire le indicazioni riportate qui di seguito.

In caso di problemi tecnici è possibile rivolgersi alla nostra linea di assistenza tecnica chiamando al numero 0900 00 1675 valido per la Svizzera (spese da rete Swisscom alla data di stampa: CHF 2.60/min). In caso di reclami entro il periodo di garanzia, rivolgersi al rivenditore autorizzato. Il periodo di garanzia ricopre 2 anni.

### Domande e risposte

Domande	Risposte
Nessuna funzione	<ul style="list-style-type: none"><li>- Radiotrasmittitore non caricato</li><li>- Blocco tastiera attivato</li></ul>
Trasmissione non è possibile	<ul style="list-style-type: none"><li>- Tenere premuto il tasto <b>PTT</b> per trasmettere</li><li>- Canale è utilizzato da un altro interlocutore</li></ul>
Nessuna ricezione	<ul style="list-style-type: none"><li>- Rilasciare il tasto <b>PTT</b></li><li>- Volume è troppo basso</li><li>- Si è al di fuori del campo di ricezione, modificare la propria posizione</li><li>- Eventuali ostacoli come alberi ed edifici hanno un influsso negativo sulla portata</li><li>- Canale è utilizzato da un altro interlocutore</li><li>- Radiotrasmittitore non è in grado di trasmettere in fase di ricarica</li><li>- Stato di carica dell'accumulatore troppo basso</li></ul>

## 6 Specifiche tecniche

### Specifiche tecniche

Caratteristica	Valore
Potenza di uscita	0,5 W
Portata	fino a 4 km - con linea di mira libera
Durata di stand-by	fino a 32 ore
Max. durata di conversazione	fino a 2 ore
Durata di carica	Min. 10 ore
Accumulatori	Accumulatori 1,2 V NiMH, 600 mAh
Alimentazione elettrica	Ingresso: 230 V, 50 Hz Uscita: 7,5 V, 200 mA

### Dichiarazione di conformità

Questo apparecchio risponde a quanto disposto dalla Direttiva UE:

1999/5/CE Direttiva concernente le apparecchiature radio, le apparecchiature terminali di telecomunicazioni e il reciproco riconoscimento della loro conformità. La conformità con la Direttiva di cui sopra viene confermata dal marchio CE applicato sull'apparecchio.

Per la dichiarazione di conformità completa si prega di voler usufruire del servizio gratuito di download dal nostro sito Internet [www.switel.com](http://www.switel.com).



## 7 Consigli per la cura / Garanzia

### Consigli per la cura

- Pulire le superfici degli apparecchi con un panno morbido e antipelucchi.
- Non utilizzare mai detergenti o solventi.

### Garanzia

Gli apparecchi SWITEL sono costruiti e collaudati in osservanza dei processi di produzione più moderni. L'impiego di materiali selezionati e tecnologie altamente sviluppate sono garanti di una perfetta funzionalità e lunga durata in vita. La garanzia non si estende a batterie, accumulatori o batterie ricaricabili utilizzati all'interno degli apparecchi. Il periodo di garanzia ricopre 24 mesi a partire dalla data di acquisto.

Entro il periodo di garanzia si procederà all'eliminazione gratuita di tutti i guasti dovuti a difetti di materiale o produzione. Il diritto di garanzia cessa in caso di interventi da parte dell'acquirente o di terzi. Danni derivanti da un impiego o esercizio non conforme agli usi previsti, a naturale usura, a errato montaggio o errata conservazione, a collegamento o installazione impropri, dovuti a forza maggiore o ad altri influssi esterni non sono coperti da garanzia. In qualità di produttore ci riserviamo il diritto, in caso di reclami, di riparare o sostituire le parti difettose o di rimpiazzare l'apparecchio. Parti o apparecchi sostituiti passano di nostra proprietà. Sono esclusi diritti di risarcimento per danni qualora non siano dovuti a intenzione o colpa grave del costruttore.

Nel caso in cui il presente apparecchio dovesse ciò nonostante presentare un difetto durante il periodo di garanzia, si prega di rivolgersi esclusivamente al negozio di rivendita dell'apparecchio SWITEL assieme al relativo scontrino di acquisto. In base alle presenti disposizioni, tutti i diritti di garanzia dovranno essere fatti valere esclusivamente nei confronti del rivenditore autorizzato. Decorso il termine di due anni dalla data di acquisto e consegna dei nostri prodotti non sarà più possibile fare valere alcun diritto di garanzia.

# Safety Information

## 1 Safety Information

Please read this operating instruction manual thoroughly.

### Intended use

These walkie-talkies have been conceived for communication with other walkie-talkies complying to the same standards. Any other use is considered unintended use. Unauthorised modification or reconstruction is not permitted. Under no circumstances open the devices or complete any repair work yourself.

### Ambient conditions

Prevent excessive exposure to smoke, dust, vibration, chemicals, moisture, heat and direct sunlight. Do not use the walkie-talkies in potentially explosive areas.

### Power adapter plug



**Attention:** Only use the power adapter plug supplied labelled with No. CSD0750200G because the use of other power adapter plugs could damage the walkie-talkies. Ensure access to the power adapter plug is not obstructed by furniture or such.

### Rechargeable batteries



**Attention:** Never throw batteries into a fire. Only use batteries of the same type. Pay attention to correct polarity. Incorrect polarity of the batteries represents a risk of explosion during charging.

### Medical equipment



**Attention:** Never use the walkie-talkies in the vicinity of medical equipment. Effects on such equipment cannot be fully ruled out. Walkie-talkies can cause an unpleasant humming sound in hearing aids.

### Disposal

In order to dispose of your device, take it to a collection point provided by your local public waste authorities (e.g. recycling centre). The adjacent symbol indicates that the device must not be disposed of in normal domestic waste! According to laws on the disposal of electronic and electrical devices, owners are obliged to dispose of old **electronic and electrical devices** in a separate waste container.

**Batteries** must be disposed of at the point of sale or at the appropriate collection points provided by the public waste authorities.

**Packaging materials** must be disposed of according to local regulations.

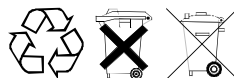

## 2 Preparing the Walkie-Talkies

### Safety information



**Attention:** It is essential to read the Safety Information in Chapter 1 before starting up.

### Checking the package contents

	WTC670	WTC673
Walkie-talkies:	2	3
Power adapter plug:	1	1
Rechargeable batteries:	6	9

	WTC670	WTC673
Belt clips:	2	3
Operating manual:	1	1

## Inserting the batteries

Open the battery compartment. Insert the batteries in the open battery compartment. Only use batteries of the type 1.2 V AAA NiMH. Pay attention to the correct polarity! Close the battery compartment.



Remove the belt clip beforehand, if necessary; Page 32.

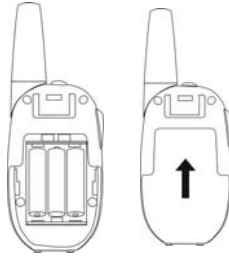

## Charging the walkie-talkies directly

Connect the power adapter plug to the walkie-talkie headset/charging socket. For safety reasons, only use the power adapter plug supplied.



Before using the walkie-talkies for the first time, charge them for at least 10 hours. Do not use the walkie-talkies when they are being charged.

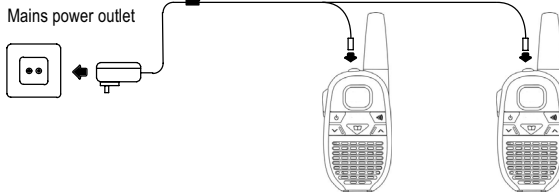

The current **battery charge status** is indicated in the display:

Full



Empty



Unit switches off



The walkie-talkies need to be recharged as soon as the indicator flashes in the display and three acoustic warning signals have been issued.

# Operating Elements

## Attaching/Detaching the belt clip

Slide the belt clip in the guide from the top until it audibly snaps into place. To detach the belt clip, prize the fastening tab up a little with your fingernail and slide the belt clip upwards.

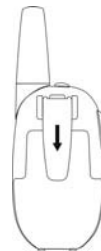

## Energy-save mode

Your walkie-talkies are provided with an energy-save mode to increase the service life of the batteries. If no buttons on the walkie-talkies are pressed for a period of 4 seconds, energy-save mode is activated. Energy-save mode is deactivated as soon as you press a button or a signal is received.

## 3 Operating Elements

The features and functions available on the walkie-talkies are explained in the diagrams below.

### Walkie-talkie

- 1 Headset/Charging socket
- 2 Antenna
- 3 Display
- 4 Transmit ringing tones
- 5 Volume + / Increase setting
- 6 Microphone
- 7 Volume - / Decrease setting
- 8 Device on/off
- 9 Menu / Key lock
- 10 PTT button

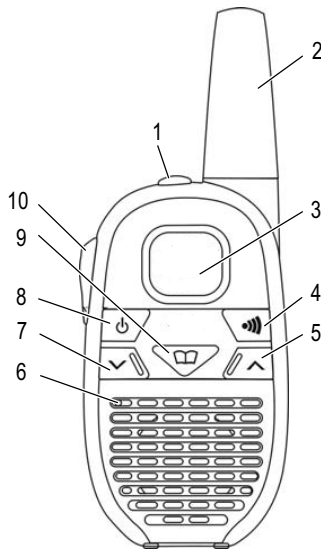





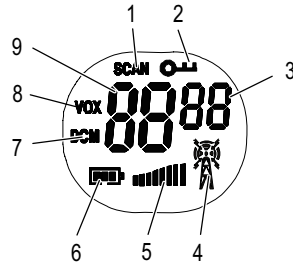

## Display

- 1 Channel scanning
- 2 Key lock activated
- 3 CTCSS code
- 4 Antenna and signal reception indicator
- 5 Volume control
- 6 Battery capacity
- 7 Dual-channel monitoring function
- 8 VOX mode
- 9 Channel













## 4 Operating the Walkie-Talkies



### Description of operating sequences in the manual

 PTT	Press the button depicted
 PTT	Press and hold the button depicted
 PTT	Release the button depicted
 Y <	Display indicator
	Speak into the microphone

### Switching the walkie-talkie on/off

 	Switch the walkie-talkie on
 	The display lights up briefly and an acoustic signal is issued. All the display icons available then appear in the display briefly, "ON" appears as well as the last channel set.
 	Switch the walkie-talkie off
 	The display lights up briefly. "OF" appears in the display and you hear an acoustic signal.
 	If you are not going to use the walkie-talkie for a longer period, we recommend removing the batteries.





### Volume control

 	Raise or lower the volume (7 levels)
	The volume level is indicated by the number of vertical lines in the display.

# Operating the Walkie-Talkies

## Transmitting and receiving

### Transmitting

When you press and hold the  button, the  icon appears in the display. On releasing the  button, you hear an acoustic signal; also refer to  Page 36.





Transmit



Hold the walkie-talkie approx. 5 to 7 cm from your mouth and speak at a normal volume. In order to talk to other subscribers, the respective walkie-talkies must be set to the same channel.

### Receiving

The unit is ready to receive calls as soon as it is switched on. When a signal is received, the  icon appears in the display.





Receive



Radio signals cannot be received when the  button is being pressed.

## Selecting a channel

PMR446 (Private Mobile Radio) walkie-talkies can be used throughout Europe free of registration and call charges. There are 8 radio channels available within the frequency range 446.000 MHz to 446.100 MHz.



Select the channel and confirm it



Every process is automatically cancelled if there is no input within 5 seconds.

Channel	Frequency (MHz)	Channel	Frequency (MHz)
1	446.00625	5	446.05625
2	446.01875	6	446.06875
3	446.03125	7	446.08125
4	446.04375	8	446.09375

## Selecting the CTCSS<sup>1</sup> code

There are 38 analogue codes (CTCSS 1 - 38) available per channel. It is only possible to communicate using the walkie-talkies when they are each set to the same channel and CTCSS/DCS code.



The CTCSS code is transmitted as an inaudible signal together with the standard voice communication. When received, the voice communication signal is only transferred to the loudspeaker when the channel and CTCSS code set on the receiver are identical to that of those received (settings on the transmitter). If, by coincidence, another subscriber is using the same channel and CTCSS code, change to a free channel together with the party being called.



2 x



Activate CTCSS code programming mode



Select the CTCSS code and confirm it

<sup>1</sup> CTCSS: Continous Tone Coded Squelch System = Selective calling

## Scanning for a channel

Signals are searched for in the eight channels in a continuous cycle. "SCAN" appears in the display. If an active channel is detected, the channel scan stops. Press the  button to enable radio communication.

## Start / End channel scanning



Start channel scanning



Resume channel scanning



End channel scanning

## Sending ringing tones

The ringing tones indicate to other subscribers that you want to talk to them. A condition for this is that the other subscribers are using the same channel.



The ringing tone is transmitted for 2 seconds

## Selecting/Deactivating ringing tones

There are 5 ringing tones available for selection. To deactivate the ringing tone, select the "OF" setting.



Open the menu



Select ringing tone and confirm it

## Monitor function

The Monitor function enables the search for weak signals on the channel currently set. If you receive an external signal, switch to a free channel. Always communicate with other subscribers on a free channel to prevent interference.



Monitor the channel



End the monitoring function

## Dual-channel monitoring

It is possible to monitor a second channel with CTCSS code in addition to the currently set channel with CTCSS code.

### Activating dual-channel monitoring



Open the menu



Select the 2nd channel and confirm it



Select the CTCSS code for the 2nd channel and confirm it

Both channels are scanned for signals. If an active channel is detected, the two-channel scan stops. Channel scanning is resumed when no signal has been transmitted on the channel for five seconds.

Press the  button to enable radio communication on this channel.

### Deactivating dual-channel monitoring



Open the menu



End dual-channel monitoring

## Key tone on/off



Open the menu



Select ON / OF and confirm it

# Operating the Walkie-Talkies

## Key lock on/off

The key lock function prevents inadvertent modification of settings. When the key lock function is activated, the  icon appears in the display.



Activate the key lock function



Deactivate the key lock function



The   and  continue to function even if the key lock function is activated.

## Confirmation signal ('Roger' beep)

The confirmation signal is issued on releasing the  button. This signals to the caller that you have ended transmission.

### Activating/Deactivating the confirmation signal



Open the menu



Select ON / OF and confirm it

## Display illumination

The display illumination lights up for 4 seconds on pressing any button except the  button.

## VOX<sup>1</sup> (handsfree)

When this function is active, the walkie-talkie automatically starts to transmit when the unit detects a voice or a sound.



When you start to speak, there is a slight delay before the walkie-talkie starts to transmit.

### Activating VOX mode

When using the handsfree function in **VOX** mode, conversation is carried out via the walkie-talkie. The  button on the walkie-talkie must not be pressed to transmit. When **VOX** mode is activated, **VOX** appears in the display.



Open the menu



Select OF or sensitivity 1, 2, 3 and confirm it

There are three sensitivity levels available for operation in VOX mode and can be selected according to the ambient noise.

1	2	3	0
Loud ambient noise	Normal ambient noise	Low ambient noise	VOX deactivated

## Headset connection port

A connection port is available beside the antenna with which to connect a headset. Use a commercially available headset without a PTT button and equipped with a 3-pin, 2.5 mm jack plug. We assume no liability for the function.

<sup>1</sup> **VOX**: Voice Operated Transmission = Activation on detecting a sound

## 5 In Case of Problems

Should problems arise with the walkie-talkies, please refer to the following information first.

In the case of technical problems, you can contact our hotline service, Tel. 0900 00 1675 (cost via Swisscom at time of going to print: CHF 2.60/min). In the case of claims under the terms of guarantee, please contact your sales outlet.

There is a 2 year period of guarantee.

### Problems and solutions

Problems	Solutions
Equipment does not function	<ul style="list-style-type: none"><li>- Walkie-talkie is not charged</li><li>- Key lock has been activated</li></ul>
Transmission is not possible	<ul style="list-style-type: none"><li>- Hold the <b>PTT</b> button pressed to transmit</li><li>- Channel is being used by other subscribers</li></ul>
No reception	<ul style="list-style-type: none"><li>- Release <b>PTT</b></li><li>- Volume setting is too low</li><li>- You are outside the range of reception, change your position</li><li>- Obstructions such as trees and buildings impair the range</li><li>- Channel is being used by other subscribers</li><li>- The walkie-talkie cannot transmit while charging</li><li>- Battery charge status too weak</li></ul>

## 6 Technical Properties

### Technical data

Feature	Value
Output power	0.5 W
Range	Up to 4 km in open space
Standby time	Up to 32 hours
Max. talk time	Up to 2 hours
Charging time	Min. 10 hours
Batteries	1.2 V NiMH batteries, 600 mAh
Power supply	Input: 230 V, 50 Hz Output: 7.5 V, 200 mA

### Declaration of Conformity

This device fulfils the requirements stipulated in the EU directive:

1999/5/EC directive on radio equipment and telecommunications terminal equipment and the mutual recognition of their conformity. Conformity with the above mentioned directive is confirmed by the CE symbol on the device.

To view the complete Declaration of Conformity, please refer to the free download available on our web site at [www.switel.com](http://www.switel.com).



# Maintenance / Guarantee

---

## 7 Maintenance / Guarantee

### Maintenance

- Clean the housing surfaces with a soft, fluff-free cloth.
- Never use cleaning agents or solvents.

### Guarantee

SWITEL equipment is produced and tested according to the latest production methods. The implementation of carefully chosen materials and highly developed technologies ensure trouble-free functioning and a long service life. The terms of guarantee do not apply to the batteries or power packs used in the products. The period of guarantee is 24 months from the date of purchase.

All deficiencies related to material or manufacturing errors within the period of guarantee will be redressed free of charge. Rights to claims under the terms of guarantee are annulled following tampering by the purchaser or third parties. Damage caused as the result of improper handling or operation, normal wear and tear, incorrect positioning or storage, improper connection or installation or Acts of God and other external influences are excluded from the terms of guarantee. In the case of complaints, we reserve the right to repair defect parts, replace them or replace the entire device. Replaced parts or devices become our property. Rights to compensation in the case of damage are excluded where there is no evidence of intent or gross negligence by the manufacturer.

If your device does show signs of a defect within the period of guarantee, please contact the sales outlet where you purchased the SWITEL device, producing the purchase receipt as evidence. All claims under the terms of guarantee in accordance with this agreement can only be asserted at the sales outlet. No claims under the terms of guarantee can be asserted after a period of two years from the date of purchase and hand-over of the product.



# **SWITEL**

## **Declaration of Conformity**



Diese Anlage entspricht der europäischen R&TTE Richtlinie.

Für die komplette Konformitätserklärung nutzen Sie bitte den kostenlosen Download von unserer Website [www.switel.com](http://www.switel.com).

Cet équipement est conforme à la directive européenne R&TTE.

Pour obtenir la déclaration de conformité intégrale, veuillez vous servir du téléchargement gratuit de notre site Internet [www.switel.com](http://www.switel.com).

Quest'apparecchiatura è conforme alla direttiva europea R&TTE.

Per la dichiarazione di conformità completa si prega di voler usufruire del servizio gratuito di download dal nostro sito Internet [www.switel.com](http://www.switel.com).

This equipment complies with the European R&TTE directive.

To view the complete Declaration of Conformity, please refer to the free download available at our web site: [www.switel.com](http://www.switel.com).

---

## **Service Hotline**

Bei technischen Problemen können Sie sich an unsere Service-Hotline unter

Tel. 0900 00 1675 innerhalb der Schweiz (Kosten Swisscom bei Drucklegung: CHF 2.60/min) wenden.

S'il s'agit de problèmes techniques, vous pouvez vous adresser à notre hotline de service en Suisse en appelant le numéro 0900 00 1675 (frais Swisscom à la date d'impression de ce manuel : CHF 2.60/min).

In caso di problemi tecnici è possibile rivolgersi alla nostra hotline di assistenza tecnica chiamando al numero 0900 00 1675 valido per la Svizzera (spese da rete Swisscom alla data di stampa: CHF 2.60 / min).

In the event of technical problems, you can contact our hotline service,

Tel. 0900 00 1675 within Switzerland (cost via Swisscom at time of going to print: CHF 2.60/min).