

SWITEL

COMMUNICATION PRODUCTS

Mobile Phone

M700



Operating Instructions

SWITEL

Operating Instructions 3

Declaration of Conformity 101

HAC Hearing Aid Compatible to M3 / T3 Rating

The M700 Phone has a built in Induction Coil and is hearing aid compatible.

To ensure optimum benefit, users with hearing aids may wish to select the T setting on their hearing aids.

Contents

1	Safety Information	4
2	Preparing the Telephone	8
3	Key Functions - Overview	16
4	Preliminary Information	20
5	Methods of Entering Data	26
6	Telephoning	28
7	Emergency Call Function	33
8	Emergency Call Function, Examples .	36
9	Starting/Ending the Emergency Call Function	40
10	Phone Book	41
11	Call List	47
12	SMS - Text Messages	49
13	Voice Mail	55
14	Services	57
15	Settings	62
16	Menu Structure	71
17	In Case of Problems	87
18	Technical Facts	91
19	SAR Information	95
20	Maintenance / Guarantee	96
21	Index	98

Safety Information

1 Safety Information

Please read this operating instruction manual thoroughly.



Risk of suffocation!

Keep packaging materials and protective foils out of reach of children.

Intended use

This telephone is designed for use when connected to a mobile phone network. Any other use is considered unintended use. Unauthorised modification or reconstruction is not permitted. Under no circumstances open the device or complete any repair work yourself.

Areas of use

- Do **not** use the phone in prohibited areas.
- Switch the phone off in the vicinity of medical equipment (e.g. in hospitals).
- Do not use the phone in petrol stations or near fuels and chemicals.
- Inquire by the airline company whether mobile phones may be used before using the phone in aircraft.

General information

- Prevent exposure to smoke, dust, vibration, chemicals, moisture, heat and direct sunlight. The phone is not waterproof; therefore, keep it dry.
- Only use original accessories and batteries. Never attempt to connect other products.
- If you want to connect the phone to another device, read the manual supplied with that device with regard to any detailed safety information. Never attempt to connect incompatible products.
- Repairs to this device may only be completed by qualified service personnel.
- All mobile communication equipment is subject to interference which may impair its performance.
- Keep the phone and accessories out of the reach of children.
- The SIM card can be removed. Caution! Small children can swallow them.
- The ringing tone is issued via the loudspeaker. Take an incoming call first and then hold the phone to your ear. This prevents any possible hearing damage.
- Only use the phone while driving or riding a transport vehicle in road traffic when using the approved hands-free equipment and appropriately positioned holders. Ensure that no safety-related functions are interfered with when

Safety Information

operating the phone. It is essential to observe the applicable laws and national regulations.

- Always maintain a distance of at least 15 cm to implanted heart pacemakers to prevent any possible interference. If you have had a pacemaker implanted, do not carry the phone in a breast pocket when switched on. Always hold the phone to the ear furthest away from the pacemaker during calls.
Switch the phone off immediately if you notice or suspect any adverse effects.
- This phone is hearing aid compatible. If you wear a hearing aid, however, please contact your doctor or the hearing aid manufacturer to inquire about any possible impairments through mobile communication equipment.
- Do not rely on the mobile phone as a safeguard for emergencies. For a variety of technical reasons, it is not possible to guarantee a reliable connection under all circumstances.

Power adapter plug



Attention: Only use the power adapter plug supplied because other power supplies could damage the telephone. Ensure access to the power adapter plug is not obstructed by furniture or such.

Rechargeable batteries



Attention: Never throw batteries into a fire. Only use batteries of the same type.

Disposal

In order to dispose of your device, take it to a collection point provided by your local public waste authorities (e.g. recycling centre). The adjacent symbol indicates that the device must not be disposed of in normal domestic waste! According to laws on the disposal of electronic and electrical devices, owners are obliged to dispose of old **electronic and electrical devices** in a separate waste container.



Batteries must be disposed of at the point of sale or at the appropriate collection points provided by the public waste authorities.



Packaging materials must be disposed of according to local regulations.

Preparing the Telephone

2 Preparing the Telephone

Safety information



Attention: It is essential to read the Safety Information in Chapter 1 before starting up.

Checking the package contents

The package contains:

1 mobile phone	1 desktop charging unit
1 Li-ion battery	1 power adapter plug
1 headset	1 operating manual



Please note that the phone is delivered with a protection film on the lens area that should be removed before use.

Barcode labels on the phone

The barcode labels contains information on the phone, such as the serial number, for example. Do not remove it.

Passwords

This mobile phone provides the option of using passwords. After activating the passwords, unauthorised third-parties cannot access the data stored on the phone. If the option is activated, access to certain functions, e.g. the phone book, is only possible after entering the correct password.

Preparing the Telephone

PIN & PIN2 codes

The **PIN** (**P**ersonal **I**dentify **N**umber) and PIN2 codes are 4 to 8-digit numbers. The PIN and PIN2 codes are given to you, together with the SIM card, by your network provider.

PUK & PUK2 codes

The **PUK** (**P**ersonal **U**nblocking **K**ey) and PUK2 codes are 4 to 8-digit numbers. These are only necessary if you enter the PIN code for the SIM card incorrectly three times in succession and the SIM card is blocked. The PUK and PUK2 codes are given to you, together with the SIM card, by your network provider.

Switching the mobile phone off and on

You can switch the mobile phone off to save the battery.

3 sec. 

Switch the phone off

3 sec. 

Switch the phone on

Preparing the Telephone

Installing the SIM card



Risk of swallowing small objects!
The SIM card can be removed.
Small children can swallow them.



The emergency call number 112 can still be dialled even if there is no SIM card installed.
The number is automatically dialled if the emergency call switch is activated!

Switch the phone off.



Pay attention that the SIM card is not bent or scratched. Prevent any contact with water, dirt or electrical charges.

Slide the mobile phone's battery compartment cover towards the bottom using a little downward pressure. Lift the battery compartment cover off the phone completely.

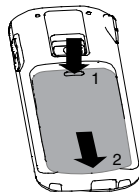

If there is already a battery inside, remove it.

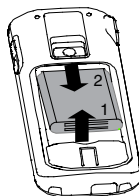

Preparing the Telephone

Slide the SIM card with the golden contacts facing down in the moulded SIM card holder.

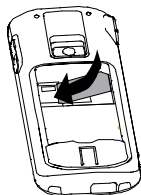

Insert the battery. The golden contacts on the battery must face towards the top left. Press lightly on the bottom end on the battery until it snaps into place.

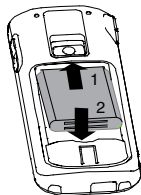

Replace the battery compartment cover back on the phone. Slider the battery compartment cover upwards until it snaps in to place. Take care to align the plastic lugs.

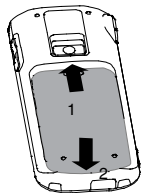

Preparing the Telephone

Charging the battery



Before starting to charge the battery, check that it has been installed properly.

Do not remove the battery while it is being charged. This could damage the phone.



When charging the battery for the first time, it should be charged for **at least** 10 hours. Some batteries only reach their full capacity after several complete charge/discharge cycles.

Charging via the mini USB port

Open the protective USB cover on the phone and plug the charging unit in the mini USB port.

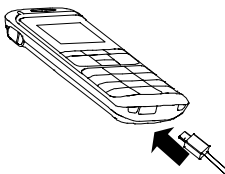

Connect the charging unit as illustrated in the diagram. For safety reasons, only use the charging unit supplied.

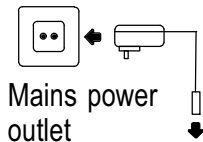

Preparing the Telephone

Charging via the desktop charging unit

Plug the connector on the adapter cable in the mini USB port on the charging unit. Insert the phone in the charging unit to charge it.

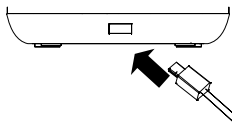

The current **battery charge status** is indicated in the display as follows:



Full



Half empty



Low



Empty



It may take a few seconds before the phone indicates the charging process.

You can use the phone during the charging process.

You can also charge the phone via a PC. To do this, connect the phone to the PC using an approved mini USB cable. The charging process takes longer via the PC than when using the charging unit.



Only use the mini USB cable approved by the mobile phone manufacturer. The terms of guarantee are annulled if a different cable is used.

Preparing the Telephone

Battery status warning

When the battery charge is low, a corresponding warning message appears in the display.

 Charge the battery.

In cases where the battery charge is extremely low, it is possible that the back-lighting no longer works and certain functions are no longer available.

 Charge the battery.

When the battery charge drops below the minimum status, the phone switches off automatically.

Tips on the battery

Only use batteries, cables and charging units approved by the manufacturer, otherwise the battery could be damaged.

Do not short circuit the battery. Always leave the battery in the phone to avoid accidentally short circuiting the battery contacts.

Keep the battery contacts clean and free of dirt.

The battery can be charged/discharged hundreds of times but its service life is limited. Replace the battery when the battery power has decreased noticeably.

Preparing the Telephone

Setting the display language

Select the language required. Refer to Menu Structure;  Page 79.

The default out of box language is English - therefore other languages are available such as French / German etc.

Setting the time and date

Set the time and date. Refer to Menu Structure;  Page 75.

Key Functions - Overview

3 Key Functions - Overview

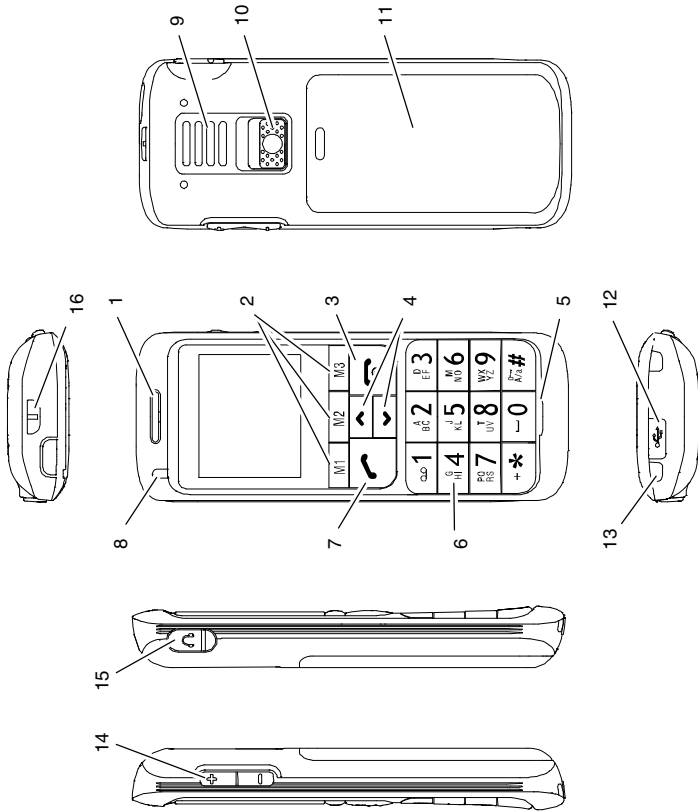

Key Functions - Overview

- 1 Earpiece
- 2 One-touch dialling buttons / Softkeys
- 3 On/Off button / End Call key
- 4 Scroll up/down button
- 5 Microphone
- 6 Keypad
- 7 Call button
- 8 LED
- 9 Loudspeaker for handsfree mode
- 10 Emergency call switch
- 11 Battery compartment cover
- 12 Mini USB port with cover
- 13 Charge contacts
- 14 Volume control
- 15 Headset socket
- 16 Attachment eye for strap







The buttons in this operating manual are subsequently depicted with a uniform contour. Therefore, slight deviations in the appearance of the symbols on the mobile phone buttons compared to those depicted here are possible.

2 **M1** **M2** **M3**

One-touch dialling buttons /
Softkeys

A phone number can be
assigned to each one-touch

Key Functions - Overview

		dialling button and then dialled directly by pressing and holding the respective button. M1 M3 are also softkeys ☞ Page 23.
3		On/Off button/End Call key Switch the mobile phone on and off. Cancel the current process. End or reject a call.
4		Scroll up/down buttons Navigate in the menus  Open the menu  Open the phone book
7	 Call button	Take a call or dial a number. Open the call list.
8	LED	Indicates the phone operating status.
9	Loudspeaker	You can hear the caller's voice from here when the phone is in Handsfree mode. The outgoing alert message is played back loud via this loudspeaker.
12		Mini USB port with cover Connect a USB plug.

Key Functions - Overview

13 Charging contacts The phone is charged via these contacts when in the charging unit.

14  Volume control
Regulates the volume of the caller.

15  Headset socket
Connect a headset.
The earpiece, loudspeaker and microphone are deactivated. You can only hear and speak via the headset.

 Only use the headset supplied with this phone. There is no guarantee that headsets from other manufacturers will work properly. Damage to the headset or mobile phone cannot be ruled out.

16 Attachment eye Attach a wrist strap (not contained in the material supplied).

Preliminary Information

Buttons with special functions

Mode	Hold <input type="button" value="✳"/>	Hold <input type="button" value="#"/>
Standby	Activate/ Deactivate the “No Alert” call setting	Activate the key lock
Incoming call	Activate the “No Alert” call setting for this call only	

Hold

A connection is established to your mailbox and you can play messages recorded;  Page 55.









4 Preliminary Information

This chapter provides basic information on using the operating instruction manual and the telephone.



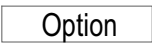



Description of operating sequences in the manual

Display	Description
<input type="button" value=""/>	Displays the contour of buttons
<input type="button" value="6<sup>MNO</sup>"/>	Press the button depicted briefly
2 sec. <input type="button" value="7<sup>PQRS</sup>"/>	Press the button depicted for 2 seconds













Preliminary Information

Hold 	Press and hold down the button depicted
	Enter numbers or letters
	Mobile phone rings
	Remove phone from the charging unit
	Place phone in the charging unit
	Represents text in the display
e.g. 	Indicates icons in the display
	Press the softkey;  Page 23

Icons and texts in the handset display

Icon	Description
	Displays the battery capacity. Pumping action indicates that the battery is being charged.
	Signal strength of the phone connection
	Alarm1 and/or Alarm2 are activated
	A headset is connected
	The key lock function is activated;  Page 30

Preliminary Information

	A roaming ¹ call is in progress
	A call is currently being made
	There are new calls in the call list;  Page 47
	A new SMS ² message has been received;  Page 49
	The microphone is deactivated (muted);  Page 30
	No call alert / silent is activated
	Ringtone only is activated
	Vibration alert only is activated
	Vibration alert is activated first, then ringing tone
	Vibration alert and ringing tone are activated

¹ Roaming calls: Outgoing or incoming international calls subject to special charges.

² **SMS: Short Message Service** = Service for sending text messages.

Preliminary Information

Standby mode

All descriptions in this operating manual assume that the mobile phone is in Standby mode. The system switches to Standby mode by pressing the  button, several times if necessary. It may be necessary to deactivate the key lock function.

Energy-save mode



When the phone has been in Standby mode for some time, it automatically switches to energy-save mode. The display no longer lights up. Press any button to reactivate Standby mode.

Softkeys

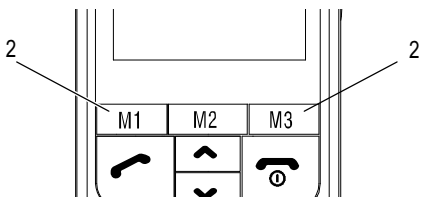
The softkeys **M1** (2) and **M3** (2) are assigned different functions in the different menus. The function buttons are always referred to in this manual according to the texts directly above them in the display.















Preliminary Information

Button	In Standby mode	In a menu
	- Open the main menu	- Various functions
	- Initiate release of the key lock function	- Various functions

Navigating in the menu



















All the functions can be accessed via the various menus. Refer to Menu Structure,  Page 71, for information on how to access each respective function.

 ()	Open the main menu
	Select the submenu required
 ()	Open the submenu
	Select the function required
	Open the function
 	Select the setting required
	Use the keypad to enter numbers or letters
 (softkey)	Confirm the entries
 (softkey)	Move one level back
	Cancel programming and saving processes and return to Standby mode

Preliminary Information

Creating phone book entries - example

The way in which to navigate through the menus and define settings is explained by means of the example **Creating phone book entries**. Proceed as in this example for all the settings.

Menu	Open the main menu
 /  Phonebook	 Select "Phonebook" and confirm it
 /  Add New	 Select the submenu and confirm it
 /  To SIM	or  To Phone  Select the memory location and confirm it
   	Open Edit mode, enter the name and confirm it
 /  Home Number	 Select another menu to edit and confirm it
 	Open Edit mode, enter the number and confirm it

Methods of Entering Data



Edit

Select another menu to edit and confirm it

Enter any further information regarding this name according to the procedure described. When all the necessary information has been entered,

Done

Ok

Conclude the phone book entry

Save?

Yes

or

No

Save or reject the entries

5 Methods of Entering Data

The keypad is also labelled with letters for the entry of text.

The phone provides various methods by which text can be entered. These are used when entering or editing contacts in the phone book, when searching for names in the phone book and when writing SMS text messages.



Not every method is always available for each application.

Methods of Entering Data

Entering text

Multitap

In order to enter text in Multitap mode, press the button labelled with the corresponding letter/character. If the first character of the group is required, press the button once. If the second character is required, press it twice, and so on.



To enter two characters assigned to the same button, press the button the respective number of times to enter the first character. Then wait for approx. 2 seconds and enter the second letter.

ABC

Multitap upper case

abc

Multitap lower case

123

Numbers



To switch between the input modes, press the **#** button.

Punctuation and special characters

To access Editing mode, press the ***** button. Punctuation marks and special characters are displayed. Use the **▲** / **▼** buttons to select the required character and insert it by pressing the **Ok** softkey. To enter a space, press **0** button.

Telephoning

6 Telephoning

Taking a call

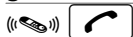

Take the call

Rejecting a call

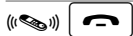

Reject the call

Ending a call



End the call

Making a call



Enter the phone number

Clear

Delete the last digit if incorrect



Dial the phone number

Call list

Your mobile phone stores the last numbers dialled (**redialling**), calls **received** and **missed calls** in a call list.



Open the call list



Select the entry and dial it

Dialling numbers from the phone book

You must have already stored phone numbers in the phone book;  Pages 25 and 41.



Open the phone book



Select the entry and dial it

Telephoning

If you have assigned several phone numbers to the entry, select the number required.

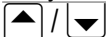

Select the relevant number



Dial the number

Quick dialling

You must have already assigned phone numbers to the one-touch buttons; Page 62.

3 sec. **M1**, **M2** or **M3**

Press the one-touch dialling button

Setting the receiver volume

The volume can be adjusted during a call.

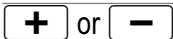

Select the required volume

Handsfree

This function is used to listen to the caller via the loudspeaker.

H-Free

Activate the handsfree function with **M3**



H-Held

Deactivate the handsfree facility

Telephoning

Muting the microphone in the handset

The microphone in the handset can be activated and deactivated during a telephone conversation.

Option	Open the menu
 /  Mute	
On	Deactivate the microphone (muting function activated)
Off	Activate the microphone



Key lock

The key lock is intended to prevent functions being triggered unintentionally.

3 sec.  Activate the key lock function



Calls can still be taken in the normal way even when the key lock function is activated.

 and then  immediately after
Deactivate the key lock function



Deactivating the ringing melody

The ringing melody can be deactivated.

3 sec.  Deactivate the ringing melody

3 sec.  Activate the ringing melody

Deactivating the ringing tone for the current call

 3 sec.  Deactivate the ringing melody

Telephoning



The ringing tone is automatically activated for the next incoming call.

Options during a call

Option

Open the “Option” menu

This menu provides access to functions which can be executed during a call:

Hold

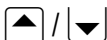

Hold

Ok

Put the current call on hold



When a call is put on hold, the menu option changes to “Retrieve”.

To retrieve the call put on hold



Retrieve

Ok

Resume the call

Handsfree



H-Free

On

Handsfree mode is activated

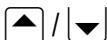

H-Free

Off

Handsfree mode is deactivated

Telephoning

New call



Ok
Select the function and activate it



Enter the phone number and dial it



The first call is put on hold.

Phone book

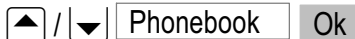

Ok
Open the phone book and use it

SMS (text messages)



Ok
Open the menu and write/edit an SMS text.

DTMF tones¹



On

Activate the DTMF tones

Off

Deactivate the DTMF tones

¹ DTMF = Dialling mode TONE,
e.g.: remote access of the answering machine in the telephone network.

Emergency Call Function

7 Emergency Call Function

This mobile phone is equipped with a convenient emergency call function. Up to 5 phone numbers can be entered for emergency calls. When the emergency call function is activated, the phone automatically switches to “handsfree”, an acoustic alarm is issued and information can appear in the display.



If **no** SIM card is installed and the emergency call switch is switched on, the emergency call number 112 is automatically dialed.

Entering/Deleting emergency call numbers

Proceed as follows to define an entry in the phone book as an emergency call number.



Each number you want to define as an emergency call number must already be stored in the phone book.

Menu

Open the main menu



Reporting Setting

Ok

Open the menu



Set Help Numbers

Ok

Open the menu



Help No.1

to Help No.5

Ok

Select the memory location

Emergency Call Function

▲ / ▼ From Phonebook Ok

Open the phone book and
select an entry

The following functions can also be used:

View View the entry

Clear Delete the entry

Sending an emergency call

You define whether an emergency call is only sent to the number entered in “Help No.1” or to all the emergency numbers entered.

Menu Open the main menu

▲ / ▼ Reporting Setting Ok
Open the menu

▲ / ▼ Set Help Numbers Ok
Open the menu









▲ / ▼ Reach Setting Ok
Open the menu

▲ / ▼ Reach All or Reach One Only Ok
Select the setting required

Emergency Call Function

Setting the duration of an emergency call







You set the length of time an emergency call should attempt to contact an emergency number. When the set time has expired, the next number is dialled.

Menu	Open the main menu
 / 	Reporting Setting 
	Open the menu
 / 	Help call duration 
	Open the menu
 / 	Off or 1 min. to 5 min. 
	Select the setting required

Entering an SOS message

You can enter a text message which appears in the display when you activate an emergency call.

 This information is **not** sent as text message but appears briefly in the mobile phone display.

Menu	Open the main menu
 / 	Reporting Setting 
	Open the menu
 / 	Predefine Help Message 
	Write/Edit an SOS message

Emergency Call Function, Examples

8 Emergency Call Function, Examples

The emergency call function is explained here using two realistic examples.



If **no** SIM card is installed and the emergency call switch is switched on, the emergency call number 112 is automatically dialed.

Emergency calls to an emergency call center

The number of the emergency call center must be stored in the phone book.



It may be necessary for you to register with an emergency call center. Ask your doctor or community services for details.

Proceed as follows:

Menu	Open the main menu
/ Reporting Setting	Ok Open the menu
/ Set Help Numbers	Ok Open the menu
/ Help No.1	Ok Select memory location 1
/ From Phonebook	Ok Open the phone book

Emergency Call Function, Examples

▲ / ▼ Ok

Select emergency call center
and confirm it

Back

▲ / ▼ Reach Setting Ok

Open the menu

▲ / ▼ Reach One Only Ok

Select the setting and store it

Back

▲ / ▼ Help call duration Ok

Open the menu

▲ / ▼ Off Ok Select the setting and store it

In the case of an emergency call:

The mobile phone dials the number of the emergency call center and switches to handsfree mode. Make the call. If the number of the emergency call center is “engaged”, up to three further attempts are automatically made to dial the number.

Emergency call to several numbers

The required phone numbers must be stored in the phone book (relatives/friends).

Proceed as follows:

Menu

Open the main menu

Emergency Call Function, Examples

▲ / ▼ Reporting Setting Ok

Open the menu

▲ / ▼ Set Help Numbers Ok

Open the menu

▲ / ▼ Help No.1 Ok

Select memory location 1

▲ / ▼ From Phonebook Ok

Open the phone book

▲ / ▼ Ok

Select an entry and confirm it

Back

▲ / ▼ Help No.2 Ok

Select memory location 2 etc.

▲ / ▼ From Phonebook Ok

Open the phone book

▲ / ▼ Ok

Select further entries and confirm them

After max. 5 emergency numbers have been dialled

Back

▲ / ▼ Reach Setting Ok

Open the menu

Emergency Call Function, Examples



Reach All

Ok

Select the setting and store it

Back



Help call duration

Ok

Open the menu



Off

Ok

Select the setting and store it

In the case of an emergency call:

The mobile phone dials the 1st emergency call number and switches to handsfree mode. When a connection is made, speak to the person answering. If the phone number is “engaged” or an answering machine replies, the mobile phone automatically dials the next emergency call number (after approx. 1 - 2 minutes).



If a time has been set for the emergency call duration (1 - 5 min.), the mobile phone automatically starts to dial the next number when this period has expired. A call in progress is automatically disconnected.

Starting/Ending the Emergency Call Function

9 Starting/Ending the Emergency Call Function

Starting the emergency call

Slide the **emergency call switch** upwards. An acoustic signal is issued when the corresponding function is activated.



The mobile phone dials the assigned number and switches to handsfree mode. Complete the call. Depending on the settings selected, the number is redialled or the next number is dialled.

Ending the emergency call

When you have finished the call or want to interrupt the emergency call, slide the emergency call switch upwards again and then press the **M1** button. Otherwise, the emergency call starts up again automatically.

10 Phone Book

Up to 500 entries (names with several related phone numbers) can be stored in the phone book.

- Always enter the area code with all the phone numbers.
- When the memory capacity is used up, the corresponding message appears when an attempt is made to store another entry. Before new entries can be stored, old entries must be deleted.
- The phone book entries are arranged alphabetically. To skip directly to a required phone book entry, press the corresponding first letter. To search for the entries manually, use the  /  buttons.



Your provider can state how many entries you can store on your SIM card.

- Entries which you have stored on the SIM card are identified by the  icon preceding the name.

Entering names

The digit keys are also labelled with letters for the entry of names. Press the corresponding button the respective number of times to enter letters.

Information on ways of entering text;  Page 26.

0

Enter a space

Phone Book

Clear

Delete

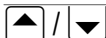

Move the cursor, to scroll

Creating phone book entries

 Page 25.

Saving in Standby mode



Enter the phone number

Save

Open the menu



To SIM

or

To Phone

Ok

Select the memory location and confirm it

Edit



Ok

Open Edit mode, enter the name and confirm it

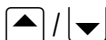

Edit

Select another menu to edit and confirm it

Complete any further information regarding this name according to the procedure described. When all the necessary information has been entered:

Done

Conclude the phone book entry

Save?





Yes

or

No

Save or reject the entries

Modifying, editing, deleting phone book entries

Menu	Open the main menu
 /  Phonebook	Ok Select "Phonebook" and confirm it
 /  Search	Ok Select the submenu and confirm it

Search for the required entry as described at the beginning of this chapter.

Option	Open the menu
--------	---------------

The following functions can also be used:

<input type="button" value="View"/>	View the entry
<input type="button" value="Edit"/>	Edit the entry
<input type="button" value="Clear"/>	Delete the entry
<input type="button" value="Copy"/>	Copy the entry (SIM ↔ phone)
<input type="button" value="Move"/>	Move the entry (SIM ↔ phone)
<input type="button" value="Send Message"/>	Send an SMS text
<input type="button" value="Send vCard"/>	Send a visiting card

Execute the functions and then confirm them.

Phone Book

Editing or deleting all entries

Menu

Open the main menu



Phonebook

Ok

Select "Phonebook" and confirm it

The following functions can also be used:

Delete All

Delete all the entries
(SIM or phone)

Copy All

Copy all the entries
(SIM or phone)

Execute the functions and then confirm them.

Groups

You can assign the entries to various groups. Groups can be displayed or hidden in order to have a better overview of the phone book. The groups can be allocated different ringing melodies.

Assigning an entry to a group

Menu

Open the main menu

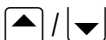

Phonebook

Ok

Select "Phonebook" and confirm it



Caller Group

Ok

Select the menu and confirm it

Phone Book

▲ / ▼ Family Ok

Select the group and confirm it

▲ / ▼ Member List Ok

Select Member List and confirm it

If there are no entries in the Member List, only the Add menu option is available.

▲ / ▼ [] Add

Select an entry from the phone book and add it

If there are entries available in the Member List, press the Option softkey. The following options Add or Clear are then available.

Changing the group name and tone

Menu Open the main menu

▲ / ▼ Phonebook Ok

Select "Phonebook" and confirm it

▲ / ▼ Caller Group Ok

Select the menu and confirm it

▲ / ▼ Family Ok

Select the group and confirm it

Phone Book

Edit

To edit the group name or

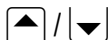

Associate Sound

Change

To select a different ringing tone

Settings

Menu

Open the main menu

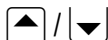

Phonebook

Ok

Select "Phonebook" and confirm it



Settings

Ok

Select menu and confirm

The following functions are available

Memory Status

The status of the SIM and phone is displayed

Fields

Select the fields in the phone book to be displayed

My vCard

in order to

Send My Card

edit them or

Send vCard



to send them

11 Call List



The mobile phone is equipped with a call list. Your mobile phone stores the last phone numbers dialled, taken and received but missed.

 If one of the phone numbers received matches an entry in the phone book, the associated name appears.



The following icons appear to indicate

-  numbers dialled,
-  calls received,
-  missed calls.

Dialling from the call list

- | | |
|---|-----------------------------|
|  | Open the call list |
|  | Select an entry and dial it |

Displaying list details

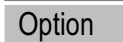
- | | |
|---|-------------------------------------|
|  | Open the call list |
|  | Select an entry and display details |
|  | Open the menu |

The following functions are available:

- | | |
|---|------------------|
|  | Delete the entry |
|---|------------------|

Call List

Save

Save the entry
(SIM or phone)

Call

Dial the entry

Edit

Edit the entry

Delete All

Delete the calls list

Execute the functions and then confirm them.

SMS - Text Messages

12 SMS - Text Messages











It is possible that not all functions described are supported by every provider. Therefore, please contact your local mobile phone provider for details.

SMS settings



SMS messages are distributed via a Service Centre. If you want to send and receive SMS text messages, you must program a service centre number in your mobile phone. Normally, this has already been set up by your service provider.

Navigating to the “Profile Setting” menu

- | | |
|--|---|
| Menu | Open the main menu |
|  /  Messages |  |
| Select the menu and confirm it | |
|  /  Message Settings |  |
| Select the menu and confirm it | |
|  /  Profile Setting |  |
| Select the menu and confirm it | |

SMS - Text Messages

SMS service center

Navigate to the “Profile Setting” menu.

▲ / ▼ Profile Setting Ok

Select the menu and confirm it

▲ / ▼ Number Edit

Select the menu and confirm it

⋮ Ok

Enter or edit the MSC number
and save the settings

Validity

You can use this feature to define how long an attempt should be made to deliver a message which you have sent.

Navigate to the “Profile Setting” menu.

▲ / ▼ Profile Setting Ok

Select the menu and confirm it

▲ / ▼ Validity Change

Select the menu and confirm it

▲ / ▼ Maximum Ok

Select the duration and
confirm it

SMS - Text Messages

Settings

Delivery report

Select “Delivery Report - On” to receive the corresponding delivery confirmation report that a message sent has been delivered.

Reply path

Select “Reply Path - On” to send the reply path of your provider with an SMS message. Contact your provider for further details.

Navigate to the “Profile Setting” menu.



 /  Common Setting 

Select the menu and confirm it

	Switch on or off
	Switch on or off

Memory status

Navigate to the “Profile Setting” menu.

 /  Memory Status 

Select the menu and confirm it

 The memory locations occupied and free on the mobile phone and SIM card are displayed.

Writing an SMS text

 A text message can contain up to 612 characters, including spaces.

 Open the main menu

SMS - Text Messages

 /  Messages 

Select the menu and confirm it

 /  Write Message 

Select the menu and confirm it



Write the text.



Information on ways of entering text;

 Page 26.



Open the menu

The following functions are available

Send Only 



or 

Enter the number or select from the phone book

Save and Send 



or 

Enter the number or select from the phone book.

The SMS text is saved in the “Outbox” folder.

Save 

The SMS text is saved in the “Outbox” folder.

Send To Many 

The message can be sent to several recipients selected from the phone book.

SMS - Text Messages

Send By Group Ok

The SMS text is sent to all the members of a group.

Execute the functions and then confirm them.

SMS text messages sent and received



Texts received are indicated by a ringing tone which you have set. “New Message!” appears in the display. Press the “Read” softkey to display the message.

SMS texts received are stored in the “Inbox” folder. SMS texts sent are saved in the “Outbox” folder as are the drafts.

Editing stored texts

Menu Open the main menu

▲ / ▼ Messages Ok

Select the menu and confirm it

▲ / ▼ Outbox / Inbox Ok

Select the menu and confirm it

▲ / ▼ +411520... View

Select the SMS text and confirm it

Option Open the menu

SMS - Text Messages

The following functions are available:

Reply	Reply to the number from which the text was sent
Forward	Forward the text to a different number
Send	Send the SMS text
Edit	Edit the SMS text
Clear	Delete the SMS text
Copy to SIM / Copy to Phone	Copy the SMS text
Move to SIM / Move to Phone	Move the SMS text
Delete All	Delete all the SMS texts
Copy All	Copy all the SMS texts (SIM or phone)
Move All	Move all the SMS texts (SIM or phone)
Use Number	Use the number from which the text was sent

Execute the functions and then confirm them.









13 Voice Mail



It is possible that not all functions described are supported by every provider. Therefore, please contact your local mobile phone provider for details. They may concern services which are subject to charges.

In order to use the “Voice Mail”¹ feature, the relevant phone number must be programmed in your mobile phone. Normally, this has already been set up by your service provider.

Setting up the Voice Mail feature

Menu	Open the main menu
 /  Messages	Ok Select the menu and confirm it
 /  Message Settings	Ok Select the menu and confirm it
 /  Voice Mail	Ok Select the menu and confirm it
 /  Empty	Edit Select the menu and start editing it

¹ Voice Mail, also referred to as mailbox (answering machine in mobile telecommunication network)

Voice Mail



If a number is already available, it appears instead of “Empty”.



Ok

Enter or edit the Voice Mail number and save it

The following functions are available in the “Voice Mail” menu.

Clear

Ok

The Voice Mail number is deleted

Connect to Voice Mail

Ok

The Voice Mail number is dialled

Execute the functions and then confirm them.

Playing the Voice Mail messages

Navigate to the “Connect to Voice Mail” menu option, as previously described, and press the **Ok** softkey or

Hold

1







A connection is established to your “Voice Mail” and you can play messages recorded.

14 Services



It is possible that not all functions described are supported by every provider. Therefore, please contact your local mobile phone provider for details. They may concern services which are subject to charges.





Navigating to the “Call Setting” menu.

Menu	Open the main menu
 /  Phone Setting	
Select the menu and confirm it	
 /  Call Setting	
Select the menu and confirm it	

Forwarding calls

The following functions enable incoming calls to be transferred to other phone numbers.

Navigate to the “Call Setting” menu.

 /  Call Divert	
Select the menu and confirm it	
Cancel All Divert	
Select the menu to stop all the calls being transferred	

Services

Select the setting for which calls should be redirected

All Voice Calls

If Unreachable

If No Answer

If Busy

and then select

Activate **Ok**  or Search **Ok**

Enter the number or select from the phone book. The call forwarding function is then active.



Deactivate **Ok** The corresponding call transfer is deactivated

Check Status **Ok** Display the current setting

Call barring

The following function is used to restrict calls which can be received and made.

Navigate to the “Call Setting” menu.

 /  Call Barring **Ok**

Select the menu and confirm it

Refer to Menu Structure;  Page 82

Changing the network password

This service must be requested from the telephone network provider. The provider then makes the corresponding numeric code available.

Navigate to the “Call Setting” menu.

▲ / ▼ Call Barring Ok

Select the menu and confirm it

▲ / ▼ Change Password Ok

Select the menu and confirm it

Refer to Menu Structure; 📖 Page 84

Call waiting

This function issues an acoustic signal to inform you that another call has been received while the current call is in progress.

Navigate to the “Call Setting” menu.

▲ / ▼ Call Waiting Ok

Select the menu and confirm it

Refer to Menu Structure; 📖 Page 82.

Automatic redialling

When this function is activated, redialling is initiated automatically if the number dialled is “engaged”.

Navigate to the “Call Setting” menu.

▲ / ▼ Auto Redial Ok

Select the menu and confirm it

Refer to Menu Structure; 📖 Page 84.

Services

SIM Toolkit

Your mobile phone supports the SIM Toolkit¹.



You receive information on: using STK, charge rates, data and offers from your SIM card service provider.

Menu

Open the main menu



SIM Toolkit

Ok

Select the menu and confirm it

Execute the functions and then confirm them.

Broadcast messages

Your mobile phone supports receiving broadcast² messages.



You receive information on: broadcast messages, charge rates, data and offers is from your SIM card service provider.

Menu

Open the main menu

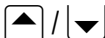

Messages

Ok

Select the menu and confirm it

¹ Sim Toolkit (STK)

(information services from your telephone network provider)

² Broadcast, also referred to as

CB = Cell Broadcast

(information services from your telephone network provider)

Services

▲ / ▼ Message Settings Ok

Select the menu and confirm it

▲ / ▼ Broadcast Message Ok

Select the menu and confirm it

Refer to Menu Structure; 📄 Page 72.

Settings





15 Settings

One-touch dialling buttons

It is possible to assign phone numbers to the one-touch dialling buttons **M1**, **M2** or **M3** which are then dialled directly by pressing and holding the corresponding button;  Page 29.

 Each number you want to define as a one-touch dialling number must be stored in the phone book.

Assigning a phone number to a one-touch dialling button:

Menu	Open the main menu
 /  Set M1/M2/M3	Ok
	Select the menu and confirm it
 /  M2 Call Number	Ok
	Select the one-touch dialling button and confirm it
Select	
View	to display the number
From Phonebook	to select and save a phone number from the phone book
Clear	to delete the number assigned

Execute the functions and then confirm them.

Clock and alarm

This menu option can be used to set and change the date, time and alarms.

Open the menu:



Select the menu and confirm it

Refer to Menu Structure; Page 75.

Calendar

This menu option opens the current calendar sheet. You can select other days and manage entries in the appointments list. Use the / buttons to navigate in the Calendar display.

Open the menu:

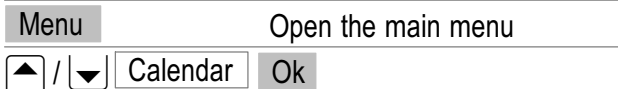

Select the menu and confirm it

Refer to Menu Structure; Page 78.

Settings

Flashing keypad

Use this menu to select whether the keypad lighting should flash in the event of incoming calls.

Menu

Open the main menu

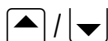

Phone Setting

Ok

Select the menu and confirm it

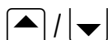

Call Setting

Ok

Select the menu and confirm it



Key LED flash

Change

Select the menu and confirm it



On

or

Off

Ok

Select the setting and confirm it

Network setting

Network selection: This menu can be used to select mobile telecommunication networks other than your own mobile network provider. However, the corresponding agreements must have been concluded.

Preferred networks: You can select the mobile telecommunication networks prescribed on the SIM card and edit them. Use the  buttons to change the priority.

Settings



It is possible that not all functions described are supported by every provider. Therefore, please contact your local mobile phone provider for details. They may concern services which are subject to charges.

Menu

Open the main menu



Phone Setting

Ok

Select the menu and confirm it



Network Setting

Ok

Select the menu and confirm it

Network Selection

or

Preferred Networks

Refer to Menu Structure; Page 84.

Navigation buttons

You can assign various menu options to the digit keys 2 to 9. Then hold the corresponding key pressed longer than 3 seconds to open the respective menu.

Menu

Open the main menu



Phone Setting

Ok

Select the menu and confirm it





Set Fast key 2-9



Ok

Select the menu and confirm it

Settings



 /  4-key 

Select the required button and confirm it

 /  Calendar 

Select the required menu and confirm it

Refer to Menu Structure;  Page 85.



 In the example above, the calendar is opened when the  button is pressed for longer than 3 seconds when in Standby mode.

Security settings

This menu is used to define which functions on the phone or SIM card should be protected by a password/PIN. The PIN and password can be changed.

 PIN and PIN2 are supplied together with the SIM card. Further information is available from your SIM card provider.

 Open the main menu

 /  Phone Setting 

Select the menu and confirm it

 /  Security Setting 

Select the menu and confirm it

Main Menu Lock

Settings



The default setting for the password is 1122. If this lock is active, you can only open the main menu by entering the password.

SIM Lock



The password is supplied together with the SIM card. If you deactivate the SIM lock, you need not enter the PIN after switching the mobile phone on.

It is recommended to leave the SIM lock on to prevent unauthorized persons from using the mobile phone.

Phone Lock



The default setting for the password is 1122. If this lock is active, you must first enter the password for the phone lock after switching the mobile phone on and then enter the PIN.

Change Password

Change the passwords/PIN

Refer to Menu Structure; Pages 85 and 86.

Phone settings

Navigating to the “Phone Setting” menu.

Menu

Open the main menu



Phone Setting

Ok

Select the menu and confirm it

Settings

Display settings

Use this menu to adapt the phone display to your own personal needs.

Navigate to the “Phone Setting” menu.

▲ / ▼ Display Setting Ok

Select the menu and confirm it

Select

Language to set the display language

Greeting Text to edit the text displayed when the phone is switched on

Screen Saver to select and setup a screen saver

Contrast to adjust the display contrast setting

LCD Backlight to set the brightness and lighting duration of the back-lighting

Font Size to set the font size in the display to “Small” or “Large”

File Manager to manage folders and audio and image files

Refer to Menu Structure;  Pages 79 and 80.

Settings

Sound settings

Use this menu to adapt the phone's ringing tones to your own personal needs.

Navigate to the "Phone Setting" menu.

▲ / ▼ Sound Setting Ok

Select the menu and confirm it

Select

Set Sound	to select specific ringing tones for various alert ringing signals
Set Volume	to select specific volumes for the various alert ringing signals
Alert Type	to select whether you are alerted of incoming calls via a ringing tone or vibration
Help Tone	to select whether an acoustic alarm should be issued when an emergency call is activated

Refer to Menu Structure; 📖 Pages 80 and 81.

Automatic key lock

You can set up the mobile phone so that the key lock is automatically activated after a certain time in Standby mode.

Settings

Navigate to the “Phone Setting” menu.



 /  Auto KeyLock 

Select the menu and confirm it

Select

The automatic function is deactivated
or

(e.g.)  



the key lock is automatically activated after the selected value

Default settings

The mobile phone is reset to its default (factory) settings.

Default settings;  Page 92.

Navigate to the “Phone Setting” menu.

 /  Restore Factory Settings



Select the menu and confirm it



Refer to Menu Structure;  Page 86.

 The default password is 1122.

16 Menu Structure

Main menu

Open the main menu by pressing the

M1 = **Menu** button. Then press the / buttons to select a menu option and confirm the selection with the Ok button.

For further information on the menu and operation,  Chapter 4.

Messages

Write Message	
	
	Send Only
	Save and Send
	Save
	Send To Many
	Send By Group
Inbox	
Outbox	



Menu Structure

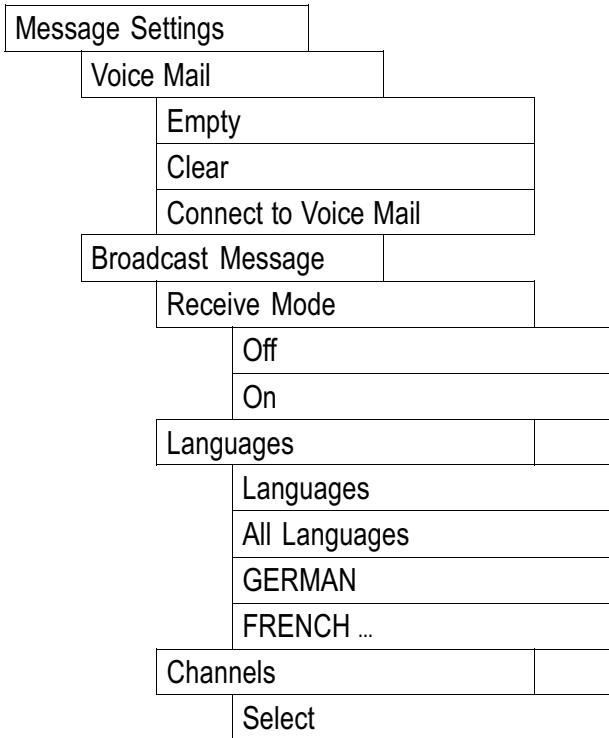

Menu Structure

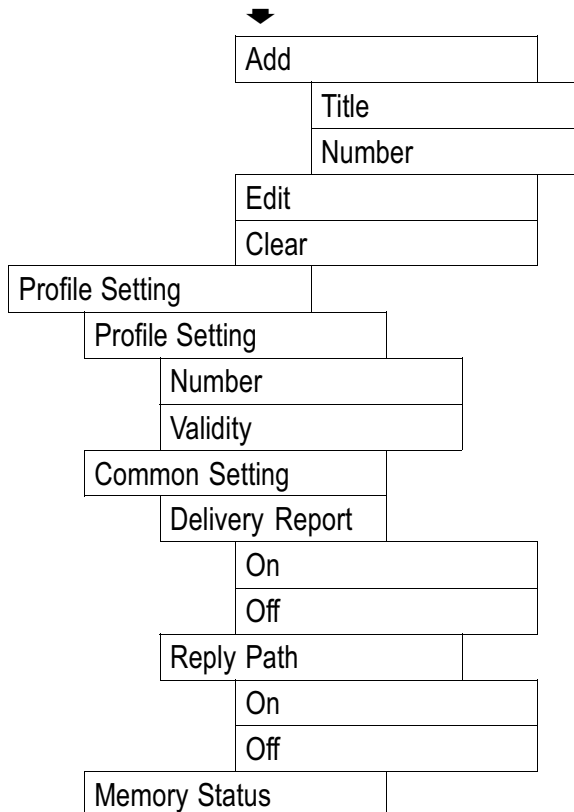

Menu Structure

Set M1/M2/M3

M1 Call Number	
----------------	--

View

From Phonebook

Clear

M2 Call Number	
----------------	--

View

From Phonebook

Clear

M3 Call Number	
----------------	--

View

From Phonebook

Clear

Clock & Alarm

Time & Date	
Set Home City	
Set Time/Date	
Set Format	
	(12/24-hour clock)
	(various date formats)
Alarm Tone Vol.	
	(select 1, 2 or 3)
	Off/On
	(set the alarm time)
	Once/Every day/Weekly
Show Time & Date	
	Off/On

Menu Structure

Phonebook

Search	
Add New	
	To SIM/To Phone
	Name
	Phone Number
	Home Number
	Company Name
	Email Address
	Office Number
	Fax Number
	Associate Sound
	Caller Group

Delete All	
	To SIM/To Phone
Copy All	
	To SIM/To Phone



Menu Structure



Caller Group	
	Friends/Family/VIP/Business/Others
	Name/Associate Sound/Member List
Settings	
	Memory Status
	Fields
	Home Number
	Company Name
	Email Address
	Office Number
	Fax Number
	Associate Sound
	Caller Group
My vCard	
	Send My Card
	Send vCard

Menu Structure

Reporting Setting

Set Help Numbers	
------------------	--

Help No.1 - 5

View/From Phonebook/Clear

Reach Setting	
---------------	--

Reach All/Reach One Only

Help call duration	
--------------------	--

Off/1-5 min.

Predefine Help Message	
------------------------	--



Calendar

View Tasks	
------------	--

Jump To Date

Phone Setting

Display Setting	
Language	
	GERMAN/ENGLISH/ FRENCH/ITALIAN/...
Greeting Text	
	Off/On
Screen Saver	
	Settings
	Off/5 sec.-1 min.
	Select
	(various images)
Contrast	
	1-8
LCD Backlight	
	Brightness
	ON Duration
	5 sec.-1 min.



Menu Structure

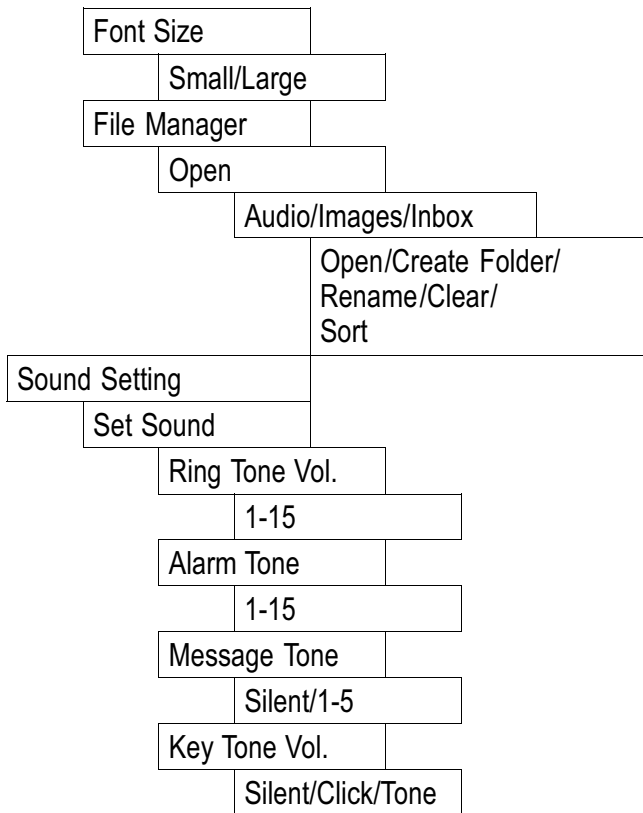

Menu Structure

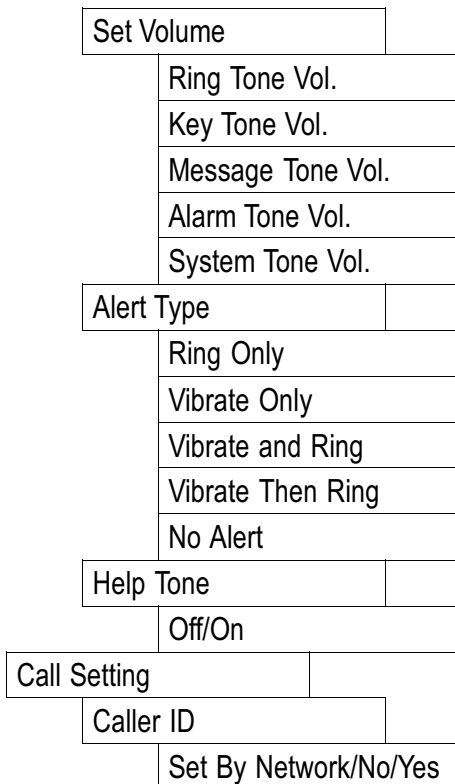

Menu Structure

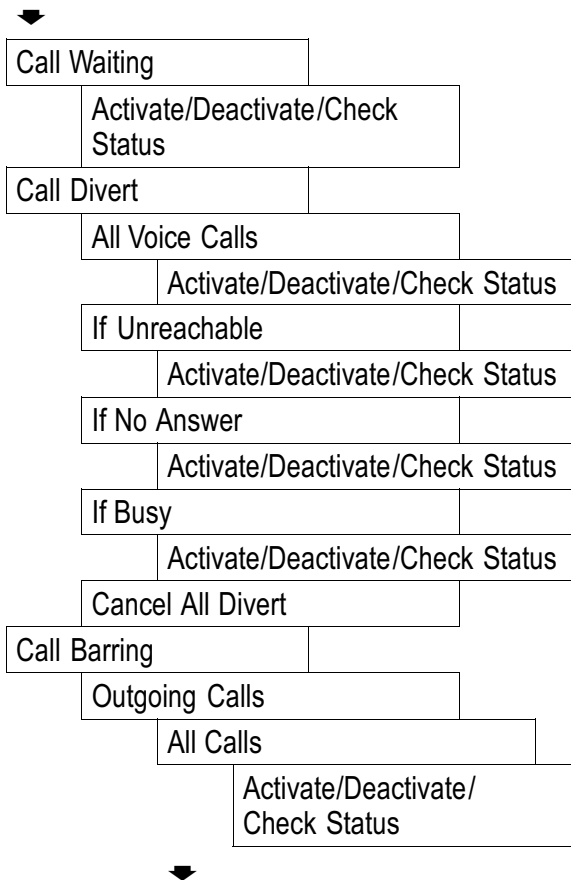

Menu Structure

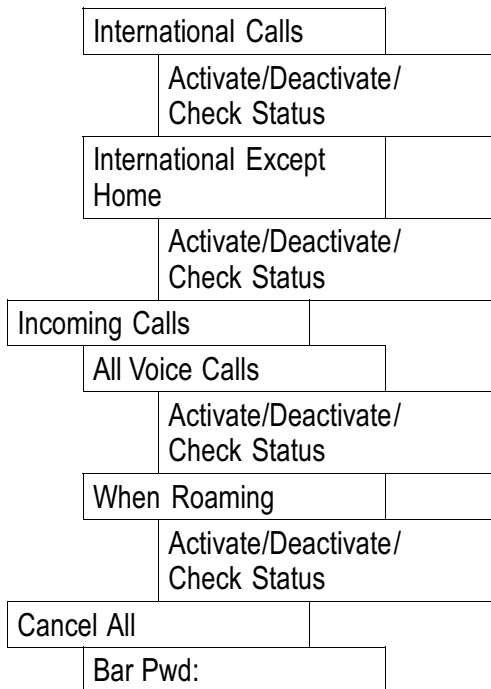

Menu Structure

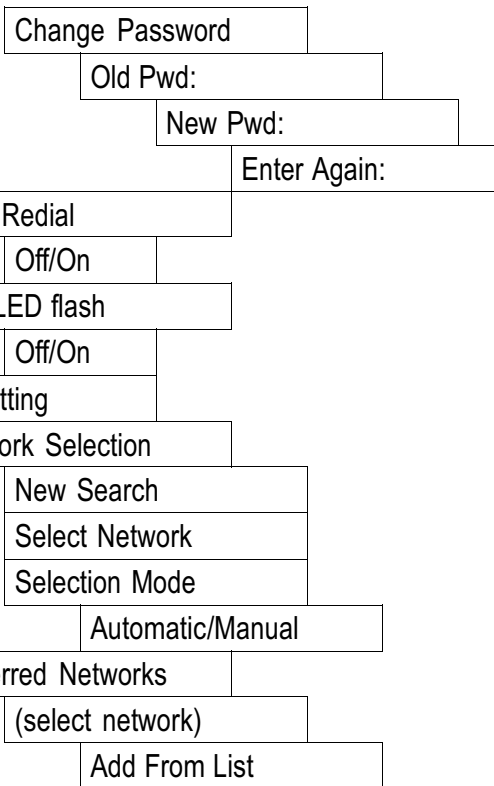

Menu Structure

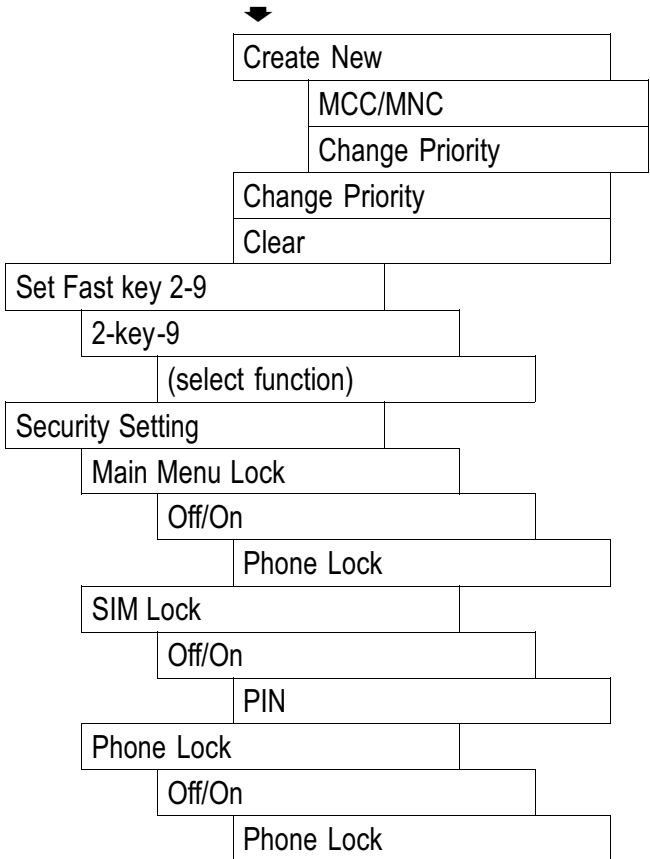

Menu Structure

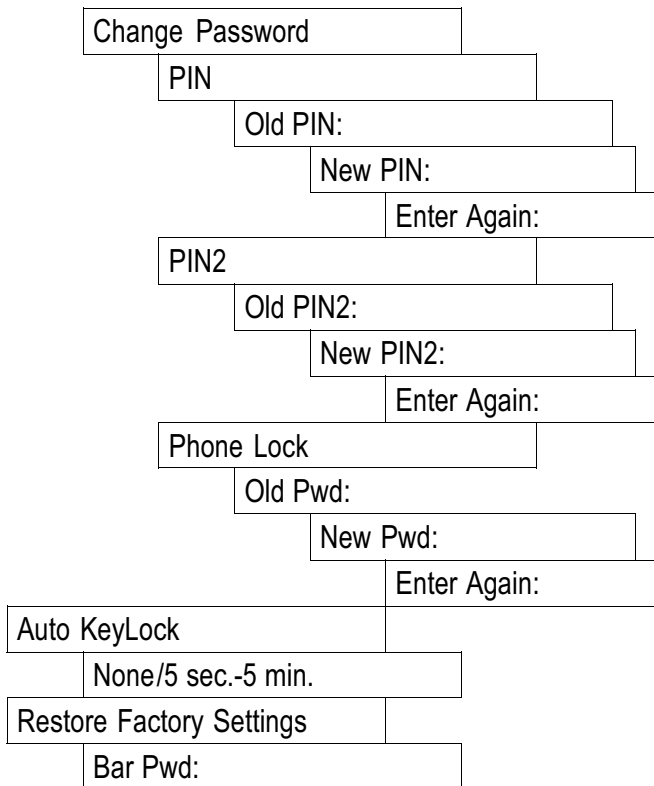

SIM Toolkit

(provider-dependent menu)

17 In Case of Problems

Service hotline

Should problems arise with the walkie-talkies, please refer to the following information first. In the case of technical problems, you can contact our hotline service, Tel. 0900 00 1675 within Switzerland (cost via Swisscom at time of going to print: CHF 2.60/min). In the case of claims under the terms of guarantee, please contact your sales outlet. There is a 2 year period of guarantee.

Problems and solutions

Problems	Solutions
The mobile phone cannot be switched on.	<ul style="list-style-type: none">- No battery inserted.- Battery is not loaded.
The display is "locked" when the mobile phone is switched on.	<ul style="list-style-type: none">- Enter the PUK to "unlock" the SIM card. Contact your service provider.

In Case of Problems

No signal quality is displayed.

- No network connection. The mobile phone is in a location where there is no network service. Move to a different location or contact your service provider.

Keypad does not function or only functions very slowly.

- The operating speed of the display is reduced in the case of low temperatures. This is normal. Use the phone in a warmer location.

A message appears in the display for some functions, indicating execution/use is not possible.

- Many functions can only be used after the respective service has been applied for. Contact your service provider for more details.

In Case of Problems

<p>No display during the charging process.</p>	<ul style="list-style-type: none">- The battery status is very low or the mobile phone is being operated outside the recommended temperature range (0° - 45 °C). Wait a few minutes or move the phone to a warmer location. Start the charging process again.
<p>No connection to the mobile telecommunication network.</p>	<ul style="list-style-type: none">- Contact your service provider.
<p>The “Insert SIM” message appears in the display.</p>	<ul style="list-style-type: none">- Ensure that the SIM card has been installed correctly. Contact your service provider, if necessary.

In Case of Problems

The battery cannot be charged or is empty within a short time.

- Battery is defect.
- Place the phone correctly in the charging unit or connect the charging unit properly. Clean the contact surfaces on the mobile phone and charging unit with a soft, dry cloth.
- Charge the mobile for 4 hours.

18 Technical Facts

Technical data

Feature	Value
Standard	GSM ¹ 900, 1800 MHz Dualband
Dimensions	50 x 128 x 16.5 mm (W x H x D)
Weight	< 100 g incl. battery
Power supply	Input: 100-240 V, 50-60 Hz, 0.2 A Output: Mini-USB 5 V, 800 mA
Battery	Model: BP-75LI 3.7 V, 750 mAh
Standby time	Up to 170 h
Max. talk time	Up to 120 h
Display	1.77" monochrome, Resolution: 128 x 128
SMS	Standard SMS

¹ **GSM** = Standard for mobile phones.

Technical Facts

Permissible ambient temperature	0°C to 40°C
Permissible relative humidity	30% to 75%



All Rights Reserved!

Default settings

The default settings can be restored via the menu. Refer to Page 86 for the sequence of menu option selections.

M1, M2, M3	Empty
Set Home City	Zürich
Time & Date-Set Format	24 Hr h
	DD/MM/YY
Show Time & Date	On
Fields	Name
	Phone Number
	Home Number
	Company Name
	Email Address
	Office Number

Technical Facts

Message Settings	Delivery Report - Off
	Reply Path - Off
	Validity - 1 day
Language	DEUTSCH
Screen Saver	Off
Set Sound	Ring Tone Vol. - 10
	Alarm Tone - 4
	Message Tone - 1
	Key Tone Vol. - Tone
Set Volume	Ring Tone Vol. - 5
	Alarm Tone - 5
	Message Tone - 5
	Key Tone Vol. - 5
	System Tone Vol. - 5
Alert Type	Ring Only
Help Tone	On
Set Fast key 2-9	2 - Language
	3 - Time & Date
	4 - Set Alarm
	5 - Call Setting
	6 - Set M1/M2/M3

Technical Facts

	7 - Inbox
	8 - Calendar
	9 - Font Size
Main Menu Lock	Off
Auto KeyLock	Off
Reach Setting	Reach All
Help call duration	Off

Declaration of Conformity

This device fulfils the requirements stipulated in the EU directive:

1999/5/EU directive on radio equipment and telecommunications terminal equipment and the mutual recognition of their conformity.

Conformity with the above mentioned directive is confirmed by the CE symbol on the device.



19 SAR Information

Information on radio frequency emissions and specific absorption rates

(**SAR = Specific Absorption Rate**).

All the applicable safety standards related to radio frequency emissions were implemented during the development of this mobile phone. The limit values are based on scientific directives and contain a safety margin in order to guarantee the safety of all persons regardless of age and state of health.

The values in the directive on radio frequency emissions are based on a unit of measure named SAR. SAR values are measured using standardized methods by which the mobile phone works in all the frequency bands used with the highest energy level. Although the SAR values of various phone models can differ, all the models were developed to maintain the relevant directives on radio frequency emissions. The following information applies to residents of countries which, as with the European Union, have adopted the SAR limit value recommended by the ICNIRP (**I**nternational **C**ommission on **N**on-**I**onizing **R**adiation **P**rotection) which lies at 2W/Kg (averaged from 10 gram tissue):

The highest SAR value measured, averaged over 10 g tissue, was < 0.526 W/kg for this mobile phone measured at the ear.

Maintenance / Guarantee

20 Maintenance / Guarantee

Maintenance

- Clean the housing surfaces with a soft, fluff-free cloth.
- Do not use any cleaning agents or solvents.

Guarantee

SWITEL equipment is produced and tested according to the latest production methods. The implementation of carefully chosen materials and highly developed technologies ensure trouble-free functioning and a long service life. The terms of guarantee do not apply when a device malfunction was caused by the mobile telecommunications network operator/provider. The terms of guarantee do not apply to the batteries or power packs used in the products. The period of guarantee is 24 months from the date of purchase.

All deficiencies related to material or manufacturing errors within the period of guarantee will be redressed free of charge. Rights to claims under the terms of guarantee are annulled following tampering by the purchaser or third parties.

Damage caused as a result of improper handling or operation, normal wear and tear, incorrect positioning or storage, improper connection or installation or Acts of Gods and other external

Maintenance / Guarantee

influences are excluded from the terms of guarantee. In the case of complaints, we reserve the right to repair defect parts, replace them or replace the entire device. Replaced parts or devices become our property. Rights to compensation in the case of damage are excluded where there is no evidence of intent or gross negligence by the manufacturer. If your device shows signs of defect during the period of guarantee, please return it to the sales outlet in which you purchased the SWITEL device together with the purchase receipt. All claims under the terms of guarantee in accordance with this agreement can only be asserted at the sales outlet. No claims under the terms of guarantee can be asserted after a period of two years from the date of purchase and hand-over of the product.

Index

21 Index

A

- Alarm, 63
- Audio settings, 69
- Automatic key lock, 69
- Automatic redialling, 59

B

- Barcode labels, 8
- Battery charge status, 12
- Battery status warning, 14
- Broadcast messages, 60

C

- Calender, 63
- Call barring, 58
- Call list, 28, 47
- Call settings, 57, 64
- Call waiting, 59
- Calling back, 28
- Calling back missed calls, 28
- Charging, 12
- Clock, 63
- Creating, 25
- Creating phone book entries, 42

D

- Date, 15
- Deactivating the
ringing melody, 30
- Declaration of Conformity, 94

- Default settings, 70, 92
- Deleting, 43
- Dialling, 28
- Display, 21
- Display icons, 21
- Display language, 15
- Display settings, 68
- Displaying list details, 47
- DTMF, 32
- During a call, 31

E

- Editing, 43
- Emergency call function, 33
- Emergency call function, exam-
ples, 36
- Emergency call to several num-
bers, 37
- Emergency calls to an emer-
gency call center, 36
- Ending a call, 28
- Ending the emergency call, 40
- Energy-save mode, 23
- Entering an SOS message, 35
- Entering names, 41
- Entering text, 41
- Entering/Deleting emergency
call numbers, 33

F

Forwarding calls, 57

G

Groups, 44

Guarantee, 96

H

Handsfree, 29, 31

Hold, 31

I

Icons, 21

K

Key Functions - Overview, 16

Key lock, 30

L

Large Font Size, 68

M

Main menu, 71

Maintenance , 96

Making a call, 28

Menu structure, 71

Methods of entering data, 26

Methods of entering text, 27

Modifying, 43

Multitap, 27

Muting, 30

Muting button, 30

N

Navigation buttons, 65

Network password, 59

Network settings, 64

New call, 32

Notation, 20

O

On-hook, 28

One-touch dialling buttons, 62

Operation, 20

P

Package contents, 8

Passwords, 8

Phone book, 28, 32, 41

Phone book entries, 25

Phone settings, 67

PIN/PIN2 code, 9

Problems, 87

Problems and solutions, 87

PUK/PUK2 code, 9

Punctuation and special characters, 27

Q

Quickdial, 29

Index

R

- Receiver volume, 29
- Redialling, 28
- Reject, 28
- Rejecting a call, 28

S

- Safety information, 4
- SAR Information, 95
- Saving, 25
- Security settings, 66
- Sending an emergency call, 34
- Service-Hotline, 87
- Services, 57, 62
- Setting the duration of an emergency call, 35
- SIM card, 10
- SIM Toolkit, 60
- SMS, 32, 49
- SMS settings, 49
- Softkeys, 23
- Standby mode, 23
- Start/End emergency call function, 40
- Starting the emergency call, 40
- Starting up, 8
- Switching off, 9
- Switching on, 9

T

- Taking a call, 28
- Technical data, 91
- Telephoning, 28
- Time, 15
- Tips on the battery, 14
- Troubleshooting, 87

V

- Voice Mail, 55

W

- Writing an SMS text, 51

SWITEL

Declaration of Conformity



Diese Anlage entspricht der europäischen R&TTE Richtlinie.
Für die komplette Konformitätserklärung nutzen Sie bitte den kostenlosen Download von unserer Website www.switel.com.

Cet équipement est conforme à la directive européenne R&TTE.
Pour obtenir la déclaration de conformité intégrale, veuillez vous servir du téléchargement gratuit de notre site Internet www.switel.com.

Quest'apparecchiatura è conforme alla direttiva europea R&TTE.
Per la dichiarazione di conformità completa si prega di voler usufruire del servizio gratuito di download dal nostro sito Internet www.switel.com.

This equipment complies with the European R&TTE directive.
To view the complete Declaration of Conformity, please refer to the free download available at our web site: www.switel.com.

Service Hotline

Bei technischen Problemen können Sie sich an unsere Service-Hotline unter Tel. 0900 00 1675 innerhalb der Schweiz (Kosten Swisscom bei Drucklegung: CHF 2.60/min) wenden.

S'il s'agit de problèmes techniques, vous pouvez vous adresser à notre hotline de service en Suisse en appelant le numéro 0900 00 1675 (frais Swisscom à la date d'impression de ce manuel : CHF 2.60/min).

In caso di problemi tecnici è possibile rivolgersi alla nostra hotline di assistenza tecnica chiamando al numero 0900 00 1675 valido per la Svizzera (spese da rete Swisscom alla data di stampa: CHF 2.60 / min).

In the event of technical problems, you can contact our hotline service, Tel. 0900 00 1675 within Switzerland (cost via Swisscom at time of going to print: CHF 2.60/min).