

SWITEL

COMMUNICATION PRODUCTS

Schnurloses DECT-/GAP-Verstärker-Telefon mit XL-Tasten und Anrufbeantworter

Téléphone sans fil DECT/GAP avec amplificateur, touches XL et répondeur

Telefono cordless DECT/GAP con amplificatore integrato, tasti XL e segreteria telefonica

Cordless DECT/GAP Amplified Telephone with XL Buttons and Answering Machine



DCT627x

Bedienungsanleitung

Mode d'emploi

Istruzioni per l'uso

Operating Instructions

D

F

I

GB

SWITEL

Bedienungsanleitung	3
Mode d'emploi	37
Istruzioni per l'uso	71
Operating Instructions	107
Declaration of Conformity	144

Inhaltsverzeichnis

1	Sicherheitshinweise	4
2	Telefon in Betrieb nehmen	5
3	Bedienelemente	8
4	Einführende Informationen	9
5	Menüstruktur	12
6	Telefonbuch	16
7	Anrufliste	18
8	Telefonieren	20
9	Erweitern des Telefonsystems	23
10	Besondere Funktionen	24
11	Nebenstellenanlagen / Zusatzdienste	24
12	Anrufbeantworter	25
13	Falls es Probleme gibt	30
14	Technische Eigenschaften	31
15	Pflegehinweise / Garantie	33
16	Stichwortverzeichnis	34

Sicherheitshinweise

1 Sicherheitshinweise

Lesen Sie diese Bedienungsanleitung sorgfältig durch.

Bestimmungsgemäße Verwendung

Dieses Telefon ist geeignet zum Telefonieren innerhalb eines Telefonnetzes. Jede andere Verwendung gilt als nicht bestimmungsgemäß. Eigenmächtige Veränderungen oder Umbauten sind nicht zulässig. Öffnen Sie das Gerät in keinem Fall selbst und führen Sie keine eigenen Reparaturversuche durch.

Aufstellungsort

Vermeiden Sie Belastungen durch Rauch, Staub, Erschütterungen, Chemikalien, Feuchtigkeit, Hitze oder direkte Sonneneinstrahlung.

Verwenden Sie das Mobilteil nicht in explosionsgefährdeten Bereichen.

Netzteil



Achtung: Verwenden Sie nur das mitgelieferte Steckernetzteil, da andere Netzteile das Telefon beschädigen können. Sie dürfen den Zugang zum Steckernetzteil nicht durch Möbel oder andere Gegenstände versperrern.

Aufladbare Akkus



Achtung: Werfen Sie Akkus nicht ins Feuer. Verwenden Sie nur Akkus des gleichen Typs! Achten Sie auf die richtige Polung! Bei verkehrter Polung der Akkus besteht beim Aufladen Explosionsgefahr.

Stromausfall

Bei Stromausfall kann mit diesem Telefon nicht telefoniert werden. Halten Sie für Notfälle ein schnurgebundenes Telefon bereit, welches ohne externe Stromversorgung arbeitet.

Medizinische Geräte



Achtung: Benutzen Sie das Telefon nicht in der Nähe von medizinischen Geräten. Eine Beeinflussung kann nicht völlig ausgeschlossen werden.

Hörgeräte-kompatibel

Das Telefon ist mit den meisten am Markt befindlichen Hörgeräten kompatibel. Eine einwandfreie Funktion mit jedem Hörgerät kann jedoch nicht garantiert werden.

DECT¹-Telefone können in Hörgeräten einen unangenehmen Brummtönen verursachen.

¹ **DECT:** Digital Enhanced Cordless Telecommunication = Standard für kabellose Telefone.

Telefon in Betrieb nehmen

Entsorgung

Wollen Sie Ihr Gerät entsorgen, bringen Sie es zur Sammelstelle Ihres kommunalen Entsorgungsträgers (z. B. Wertstoffhof). Das nebenstehende Symbol bedeutet, dass Sie das Gerät auf keinen Fall in den Hausmüll werfen dürfen! Nach dem Elektro- und Elektronikgerätegesetz sind Besitzer von Altgeräten gesetzlich gehalten, alte **Elektro- und Elektronikgeräte** einer getrennten Abfallerfassung zuzuführen.



Akkus entsorgen Sie beim batterievertreibenden Handel sowie bei zuständigen Sammelstellen, die entsprechende Behälter bereitstellen.



Verpackungsmaterialien entsorgen Sie entsprechend den lokalen Vorschriften.

2 Telefon in Betrieb nehmen

Sicherheitshinweise



Achtung: Lesen Sie vor der Inbetriebnahme unbedingt die Sicherheitshinweise in Kapitel 1.

Verpackungsinhalt prüfen

Zum Lieferumfang gehören:

Inhalt	DCT627x-Modell ¹			
	6271	6272	6273	6274
Basisstation mit Netzteil	1	1	1	1
Ladestation mit Netzteil	-	1	2	3
Mobilteil	1	2	3	4
Telefonanschlusskabel	1	1	1	1
Akkus	2	4	6	8
Bedienungsanleitung	1	1	1	1

Basisstation anschließen



Achtung: Stellen Sie die Basisstation mit einem Mindestabstand von 1 m zu anderen elektronischen Geräten auf, da es sonst zu gegenseitigen Störungen kommen kann.

¹ Unter www.switel.com erfahren Sie, ob dieses Telefon/Telefonset bereits erhältlich ist.

Telefon in Betrieb nehmen

Schließen Sie die Basisstation wie auf der Skizze abgebildet an. Verwenden Sie aus Sicherheitsgründen nur das mitgelieferte Netzteil sowie das beigelegte Telefonanschlusskabel.

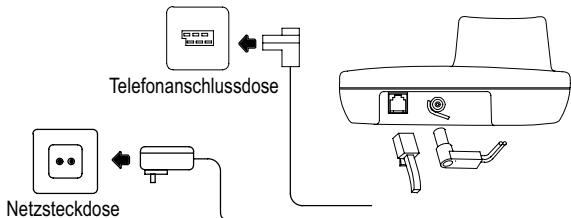

Verwenden Sie für die Basisstation das Netzteil mit der Nr. KG2B-075-0320D und den Ausgangsdaten 7,5 V, 320 mA.

Ladestation anschließen¹

Schließen Sie die Ladestation wie auf der Skizze abgebildet an. Verwenden Sie aus Sicherheitsgründen nur das mitgelieferte Netzteil.

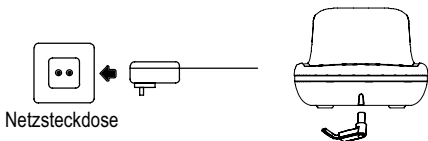

Verwenden Sie für die Ladestation das Netzteil mit den Ausgangsdaten 6 V, 150 mA.

Akkus einlegen

Legen Sie die Akkus in das geöffnete Akkufach ein. Verwenden Sie nur Akkus des Typs AAA NiMH 1,2 V. Achten Sie auf die richtige Polung! Schlie-

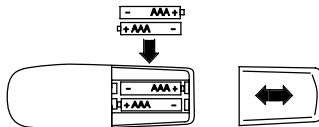

¹ Gilt nur für Telefonsets mit mindestens zwei Mobilteilen ☞ "Verpackungsinhalt prüfen" auf Seite 5.

Telefon in Betrieb nehmen

ßen Sie das Akkufach.

Akkus aufladen



Stellen Sie das Mobilteil bei der ersten Inbetriebnahme für **mindestens 16 Stunden** in die Basisstation / Ladestation.

[Haben Sie das Mobilteil richtig in die Basisstation / Ladestation gestellt, ertönt ein Hinweisignal.] [Haben Sie das Mobilteil richtig in die Basisstation / Ladestation gestellt, leuchtet die Ladekontrollleuchte.] Das Mobilteil erwärmt sich beim Laden. Dies ist normal und ungefährlich. Laden Sie das Mobilteil nicht mit fremden Aufladegeräten. Der aktuelle **Akkuladezustand** wird im Display angezeigt:



Voll



Halb



Schwach



Leer

Displaysprache einstellen

Wählen Sie die entsprechende Sprache aus (siehe auch "Menüstruktur"):

 > MOBILTEIL > SPRACHE >...

Es stehen die Sprachen Deutsch, Französisch, Italienisch und Englisch zur Verfügung.

Datum und Uhrzeit des Mobilteils einstellen

Datum und Uhrzeit stellen Sie über das Menü ein. Auf Seite 13 finden Sie die Position im Menü.

Automatische Anrufannahme

Haben Sie diese Funktion aktiviert, wird ein Anruf automatisch beim Herausnehmen des Mobilteils aus der Basisstation angenommen. Die automatische Anrufannahme wird über das Menü aktiviert oder deaktiviert. Auf Seite 14 finden Sie die Position im Menü.

Nebenstellenanlagen

Auf Seite 24 erhalten Sie weitere Informationen, falls Sie Ihr Telefon an eine Nebenstellenanlage anschließen möchten.

Strahlungsreduzierung (ECO-Mode)

Die Strahlung wird im Vergleich zu Standard-DECT-Schnurlostelefonen im Bereitschaftsmodus erheblich verringert, wenn das Mobilteil in der Basis steht.

Im Gesprächsmodus wird die Strahlung abhängig von der Entfernung des Mobilteils zur Basis verringert.



Bedienelemente

3 Bedienelemente

Die Tasten Ihres Telefons werden in dieser Bedienungsanleitung nachfolgend mit vereinheitlichten umrandeten Symbolen dargestellt. Leichte Abweichungen der Tastensymbole Ihres Telefons gegenüber den hier verwendeten Tastensymbolen sind daher möglich.

Mobilteil

- 1 Lautsprecher
- 2 LCD-Display
- 3 Menü-/OK-Taste
- 4 Schnellwahl Taste M2
- 5 Headsetanschluss
- 6 Lösch-/R-Taste
- 7 Freisprechtaste
- 8 Zifferntastenblock
- 9 #-Taste / Tastensperre
- 10 Mikrofon
- 11 Pausetaste
- 12 *-Taste / Interngespräche
- 13 Gesprächs-/Auflegetaste
- 14 Pfeiltaste unten / Anrufliste
- 15 Schnellwahl Taste M1
- 16 Pfeiltaste oben / Wahlwiederholung
- 17 LED

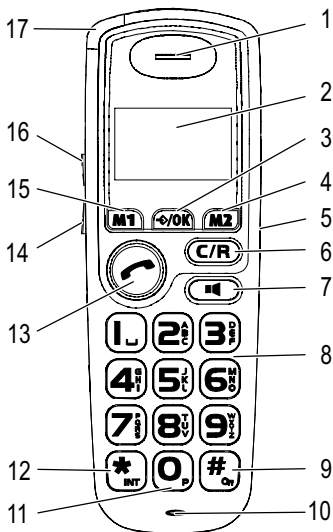

Headsetanschluss

Auf der rechten Seite des Mobilteils finden Sie eine Anschlussmöglichkeit für ein Headset. Verwenden Sie ein Headset mit einem 2,5 mm Stereoklinkenstecker. Eine Funktionsgarantie kann nicht übernommen werden.

Einführende Informationen

Basisstation



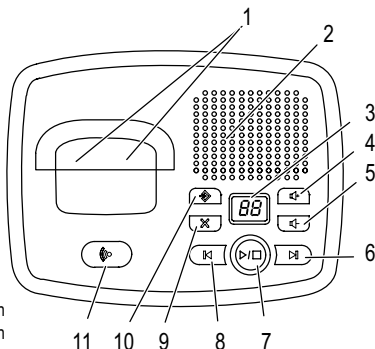



- 1 Ladekontakte
- 2 Lautsprecher
- 3 LC-Display
- 4 Lautstärke +
- 5 Lautstärke -
- 6 Menü vor / nächste Nachricht
- 7 Abspielen / Stopp / Einstellung bestätigen/beenden
- 8 Menü zurück / vorherige Nachricht
- 9 Nachricht/Ansage löschen
- 10 Menü / Einstellung ändern
- 11 Paging-Taste





4 Einführende Informationen

In diesem Kapitel finden Sie grundlegende Informationen zur Handhabung der Bedienungsanleitung und des Telefons.









Darstellungsweise in der Bedienungsanleitung

Darstellung	Beschreibung
	Darstellung von Tasten
	Abgebildete Taste kurz drücken
2 Sek. 	Abgebildete Taste 2 Sekunden drücken
	Nummern oder Buchstaben eingeben
	Mobilteil klingelt
	Mobilteil aus der Basisstation nehmen
	Mobilteil in die Basisstation stellen

Einführende Informationen

	Darstellung von Display-Texten
	Darstellung von Display-Symbolen

Symbole und Texte im Display des Mobilteils

Symbol	Beschreibung
	Konstant: Anzeige der Batteriekapazität. Blinkend: Laden Sie die Akkus. Durchlaufende Segmente: Die Akkus werden geladen ➔ Seite 7.
1	Interne Rufnummer des Mobilteils ➔ Seite 23.
12--59	Anzeige der Uhrzeit ➔ Seite 13.
	Sie führen ein Gespräch ➔ Seite 20.
	Sie befinden sich in der Anrufliste. Es sind neue Anrufe in der Anrufliste ➔ Seite 18.
	Der Tonruf ist ausgeschaltet ➔ Seite 13.
	Das Freisprechen ist aktiviert ➔ Seite 22.
	Die Tastensperre ist aktiviert ➔ Seite 22.
	Die Alarmfunktion ist eingeschaltet.
NEUE NACHRICHT	Anrufbeantworter im Telefonnetz. VMWI ¹ - Zusatzdienst Ihres Netzbetreibers ➔ Seite 25.
	Die Verbindung zur Basisstation ist gut.

Bereitschaftsmodus

Alle Beschreibungen in dieser Bedienungsanleitung gehen davon aus, dass sich das Mobilteil im Bereitschaftsmodus befindet. Das Mobilteil ist im Bereitschaftsmodus, wenn kein Gespräch geführt wird und kein Menü geöffnet ist. Drücken Sie ggf. die Taste  mehrfach, um in den Bereitschaftsmodus zu gelangen.













¹ **VMWI**: Visual Message Waiting Indication = Optische Anzeige neuer Nachrichten.

Einführende Informationen

Navigation im Menü

Alle Funktionen sind über unterschiedliche Menüs zu erreichen. Den Weg zur gewünschten Funktion entnehmen Sie der Menüstruktur

☞ Seite 12.









	Hauptmenü öffnen
 oder 	Gewünschtes Untermenü auswählen
	Untermenü öffnen
 oder 	Gewünschte Funktion auswählen
	Funktion öffnen
 oder 	Gewünschte Einstellung auswählen
	Über Tastenfeld Nummern oder Buchstaben eingeben
	Eingaben bestätigen
	Eine Ebene zurück
ggf. mehrfach 	Programmier- und Speichervorgänge abbrechen und in den Stand-by-Modus zurückkehren



Jeder Vorgang wird automatisch abgebrochen, wenn innerhalb von 15 Sekunden keine Eingabe erfolgt.

Telefonbucheinträge erstellen - Beispiel





Wie Sie in den Menüs navigieren und Einstellungen vornehmen, ist hier anhand des Beispiels **Telefonbucheinträge erstellen** erklärt. Verfahren Sie bei allen Einstellungen wie in diesem Beispiel.

	Hauptmenü öffnen
TELEFONBUCH 	Telefonbuch öffnen
	Auswahl von Einträgen überspringen
NEUER EINTRAG 	Untermenü auswählen und bestätigen
 	Namen eingeben (max. 12 Stellen) und bestätigen
 	Rufnummer eingeben (max. 24 Ziffern) und bestätigen



Menüstruktur





5 Menüstruktur



Hauptmenü



In das Hauptmenü gelangen Sie, wenn Sie die Taste  drücken. Danach wählen Sie mit den Tasten  oder  einen Eintrag aus und bestätigen Sie Ihre Auswahl mit der Taste .

Weitere Informationen zum Menü und zur Bedienung  Kapitel 4.

TELEFONBUCH, / Eintrag auswählen,  überspringen

NEUER EINTRAG	NAME  ¹	NUMMER 
ÄNDERN	NAME 	NUMMER 
LÖSCHEN	BESTÄTIGEN?	
ALLE LÖSCH.	BESTÄTIGEN?	

ANRUFLISTE², / Eintrag auswählen,  überspringen

SPEICHERN	NAME 	NUMMER 
LÖSCHEN	BESTÄTIGEN?	
ALLE LÖSCH.	BESTÄTIGEN?	

¹ Die Zifferntasten sind mit Buchstaben beschriftet. Durch mehrmaliges Drücken der entsprechenden Taste können Buchstaben, Ziffern und Sonderzeichen eingegeben werden.

² Für das Anzeigen und Speichern von Rufnummern in Anruflisten wird die Rufnummernanzeige (**CLIP**³) benötigt. Die Rufnummernanzeige ist ein Zusatzdienst Ihres Netzbetreibers. Fragen Sie Ihren Netzbetreiber nach weiteren Informationen. Weitere Informationen zur Rufnummernanzeige  Seite 18.

³ **CLIP**: Calling Line Identification Presentation = Anzeige der Rufnummer eines Anrufers.

Menüstruktur

WAHLWIEDERH., / Eintrag auswählen, überspringen

SPEICHERN	NAME	NUMMER
LÖSCHEN	BESTÄTIGEN?	
ALLE LÖSCH.	BESTÄTIGEN?	



ALARM

ALARM 1	AUS		
	AN	UHRZEIT	BESTÄTIGEN?
ALARM 2	AUS		
	AN	UHRZEIT	BESTÄTIGEN?

MOBILTEIL

RUFTÖNE	RUFTON EXT.	MELODIE 1-10
	RUFTON INT.	MELODIE 1-10
LAUTSTÄRKE	LAUTSTÄRKE 1-5, AUS	
DATUM/ZEIT	DATUM/ZEIT EINSTELL.	DATUM
		BESTÄTIGEN?
		UHRZEIT
		BESTÄTIGEN?
	DATUM/ZEIT FORMAT	DATUM
		TT/MM
		MM/TT



Menüstruktur

↙		UHRZEIT  ↘
		↘ 12 STD.
		↘ 24 STD.
HÖRVERSTÄRK.	AN	LEISE
		MITTEL
		LAUT
	AUTOMATISCH	
	AUS	
TASTENTON	AN/AUS	
DISPLAY KONTRAST	STUFE 1-8	
MT-NAME		
BELEUCHTUNGS EIN- STELLUNG	5-30 SEKUNDEN	
AUTO ANNAHME	AN/AUS	
SPRACHE ¹		
RÜCKSETZEN	BESTÄTIGEN?	



¹Welche Sprachen zur Verfügung stehen siehe  Kapitel 2.

Menüstruktur

BASIS, PIN EINGEBEN 1

RUFTÖNE	MELODIE 1-5	
LAUTSTÄRKE	LAUTSTÄRKE 1-5, AUS	
PIN ÄNDERN ¹	NEUER PIN 	PIN BESTÄT. 
WAHLVERFAHR.	TONWAHL	
	PULSWAHL	
FLASH-ZEIT	KURZ	
	MITTEL	
	LANG	
VMWI ²	VMWI OFF?	
RESET	BESTÄTIGEN?	

AN-/ABMELDEN

ANMELDEN	PIN EINGEBEN 	
BASIS WÄHLEN	BASIS 1-4	
MOBILTEIL ABMELDEN	PIN EINGEBEN 	MOBILTEIL 1-4
BASIS ABMEL.	BASIS 1-4	

¹ Der PIN-Code ist werkseitig auf "0000" eingestellt.

² **VMWI: Visual Message Waiting Indication** = Optische Anzeige neuer Nachrichten.

Telefonbuch

6 Telefonbuch

Im Telefonbuch können Sie 100 Rufnummern mit den dazugehörigen Namen speichern.

- Geben Sie bei allen Rufnummern immer die Vorwahl mit ein, damit auch eingehende Ortsgespräche einem Telefonbucheintrag zugeordnet werden können.
- Ist die Speicherkapazität erschöpft, zeigt das Display beim nächsten Speichern die Meldung **SPEICH. VOLL**. Um wieder Platz zu schaffen, müssen Sie zuerst einen anderen Eintrag löschen.
- Die Telefonbucheinträge sind alphabetisch geordnet.

Namen eingeben

Die Zifferntasten sind mit Buchstaben beschriftet. Durch mehrmaliges Drücken der entsprechenden Taste können Buchstaben, Ziffern und Sonderzeichen eingegeben werden.

1	Leerzeichen eingeben
C	Löschen
▲ oder ▼	Cursor bewegen



Um den gleichen Buchstaben zweimal einzugeben, drücken Sie die entsprechende Taste. Warten Sie, bis der Cursor eine Stelle weitersprungen ist. Geben Sie den Buchstaben erneut ein.

Telefonbucheinträge erstellen

	Hauptmenü öffnen
TELEFONBUCH	Telefonbuch öffnen
	Auswahl von Einträgen überspringen
NEUER EINTRAG	Untermenü auswählen und bestätigen
	Namen eingeben (max. 12 Stellen) und bestätigen
	Rufnummer eingeben (max. 24 Ziffern) und bestätigen

Telefonbuch

Telefonbucheinträge ändern

<input type="button" value="↔"/>	Hauptmenü öffnen
<input type="button" value="TELEFONBUCH"/> <input type="button" value="↔"/>	Telefonbuch öffnen
<input <input="" oder="" type="button" value="↔" ▼,=""/>	Eintrag auswählen, bestätigen
<input <input="" oder="" type="button" value="ÄNDERN" ▼,=""/> <input type="button" value="↔"/>	Untermenü auswählen und bestätigen
<input button"="" type="button" value="↔"/>	Namen ändern und bestätigen
<input button"="" type="button" value="↔"/>	Rufnummer ändern und bestätigen

Telefonbucheinträge löschen

Einen Eintrag löschen

<input type="button" value="↔"/>	Hauptmenü öffnen
<input type="button" value="TELEFONBUCH"/> <input type="button" value="↔"/>	Telefonbuch öffnen
<input <input="" oder="" type="button" value="↔" ▼,=""/>	Eintrag auswählen, bestätigen
<input <input="" oder="" type="button" value="LÖSCHEN" ▼,=""/> <input type="button" value="↔"/>	Untermenü auswählen und bestätigen
<input type="button" value="BESTÄTIGEN?"/> <input type="button" value="↔"/> oder <input type="button" value="C"/>	Löschvorgang bestätigen oder abbrechen

Alle Einträge löschen

<input type="button" value="↔"/>	Hauptmenü öffnen
<input type="button" value="TELEFONBUCH"/> <input type="button" value="↔"/>	Telefonbuch öffnen
<input type="button" value="↔"/>	Auswahl von Einträgen überspringen
<input <input="" oder="" type="button" value="ALLE LÖSCH." ▼,=""/> <input type="button" value="↔"/>	Untermenü auswählen und bestätigen
<input type="button" value="BESTÄTIGEN?"/> <input type="button" value="↔"/> oder <input type="button" value="C"/>	Löschvorgang bestätigen oder abbrechen

Anrufliste

Direktwahl

Sie können jeweils 1 Rufnummer als Direktwahl auf den Tasten **M1** und **M2** speichern.

Rufnummern als Direktwahl speichern

Geben Sie eine Nummer ein oder wählen Sie einen Eintrag aus dem Telefonbuch, der Wahlwiederholung oder der Anrufliste.

3 Sek. **M1** oder **M2**

Auswahl auf entsprechender Direktwahl-Taste gespeichert



Einträge auf Direktwahltasten können nicht gelöscht, sondern nur überschrieben werden.

7 Anrufliste

Insgesamt werden 20 Rufnummern in einer Anrufliste gespeichert.



Die Rufnummernanzeige (**CLIP**¹) ist ein Zusatzdienst Ihres Netzbetreibers. Ihr Telefon zeigt die Rufnummern im Display, wenn Ihr Netzbetreiber diesen Service anbietet. Bitte fragen Sie Ihren Netzbetreiber nach weiteren Informationen.

Meldungen im Display:

UNBEKANNT	Die Rufnummer wurde nur teilweise oder fehlerhaft empfangen.
UNBEKANNT	Die Information der Rufnummer ist nicht verfügbar. Es könnte sich um ein internationales Gespräch handeln.
PRIVAT	Der Anrufer hat das Senden seiner Rufnummer unterdrückt.

Rufnummern aus der Anrufliste anzeigen

oder

Anrufliste öffnen und Eintrag auswählen











Drücken Sie die Taste ggf. mehrfach, um im Display zwischen den Anzeigen "Name", "Nummer" und "Eingangs-Uhrzeit/Datum" zu wechseln.

¹ **CLIP**: Calling Line Identification Presentation = Anzeige der Rufnummer eines Anrufers.

Anrufliste

Rufnummer aus der Anrufliste im Telefonbuch speichern

Eine Rufnummer kann direkt aus der Anrufliste im Telefonbuch gespeichert werden.









 ,  oder 	Anrufliste öffnen und Eintrag auswählen
	Menü öffnen
 oder  , SPEICHERN , 	Untermenü auswählen und bestätigen
 , 	Namen eingeben (max. 12 Stellen) und bestätigen
 , 	Rufnummer ändern und bestätigen









Sobald die Rufnummer im Telefonbuch mit einem Namen gespeichert wurde, erscheint in der Anrufliste der eingegebene Name.

Rufnummern aus der Anrufliste löschen

Einzelne Rufnummer löschen

 ,  oder 	Anrufliste öffnen und Eintrag auswählen
	Menü öffnen
 oder  , LÖSCHEN , 	Untermenü auswählen und bestätigen
BESTÄTIGEN? ,  oder C	Löschvorgang bestätigen oder abbrechen

Alle Rufnummern löschen

	Anrufliste öffnen
	Menü öffnen
 oder  , ALLE LÖSCH. , 	Untermenü auswählen und bestätigen
BESTÄTIGEN? ,  oder C	Löschvorgang bestätigen oder abbrechen

Telefonieren

8 Telefonieren

Anruf annehmen

,  oder  Anruf annehmen

Gespräch beenden

 Gespräch beenden

Anrufen

 Rufnummer eingeben (max. 24 Ziffern)

 Bei Falscheingabe letzte Ziffer löschen



 oder  Rufnummer wählen



Sie können auch zuerst die Taste  drücken und erhalten damit das Freizeichen. Die eingegebenen Ziffern Ihrer gewünschten Rufnummer werden sofort gewählt. Eine Korrektur einzelner Ziffern der Rufnummer ist bei dieser Form des Gesprächsaufbaus nicht möglich.

Wahlwiederholung

Ihr Telefon speichert die 10 zuletzt gewählten Rufnummern in einer Wahlwiederholungsliste.

,  oder  Wahlwiederholungsliste öffnen und Eintrag auswählen

 Verbindung herstellen

Das Bearbeiten von Rufnummern in einer Wahlwiederholungsliste ist identisch zur Bearbeitung von Rufnummern in der Anruferliste

☞ Kapitel 7.

Eingegangene Anrufe zurückrufen

Ihr Telefon speichert 20 Rufnummern in einer Anrufliste.

,  oder  Anrufliste öffnen und Eintrag auswählen

 Verbindung herstellen

Rufnummern aus dem Telefonbuch wählen

Sie müssen Rufnummern im Telefonbuch gespeichert haben

☞ Kapitel 6.

 Hauptmenü öffnen

TELEFONBUCH  Telefonbuch öffnen

 oder ,  Eintrag auswählen, Verbindung herstellen

Telefonieren

Direktwahl

Sie müssen Rufnummern als Direktwahlnummer gespeichert haben  Kapitel 5.

3 Sek. **M1** oder **M2** Direktwahl durchführen

Intern telefonieren¹

Interne Gespräche führen

Sie müssen zwei oder mehr Mobilteile (MT1, MT2, ...) an Ihrer Basisstation angemeldet haben, um interne kostenlose Gespräche führen zu können.

MT1: 3 Sek. **INT** Internes Telefonieren einleiten

z. B. **2^{ABC}** Interne Rufnummer des gewünschten Mobilteils wählen

MT2:  Internes Gespräch am anderen Mobilteil annehmen

MT1 / MT2:  Internes Gespräch beenden

Externe Gespräche intern weiterleiten

MT1: 3 Sek. **INT** Während des externen Gesprächs

z. B. **2^{ABC}** Interne Rufnummer wählen

MT2:  Internes Gespräch am anderen Mobilteil annehmen

MT1:  Gespräch weiterleiten



Sollte sich das gerufene Mobilteil nicht melden, wird das externe Gespräch nach 30 Sek. an das rufende Mobilteil zurückgestellt.

Konferenzgespräche führen

Ein externes Gespräch kann mit einem weiteren internen Gesprächspartner zum Konferenzgespräch geschaltet werden.

MT1: 3 Sek. **INT** Während des externen Gesprächs

z. B. **2^{ABC}** Interne Rufnummer wählen

MT2:  Internes Gespräch am anderen Mobilteil annehmen

MT1: 3 Sek. **INT** Konferenz starten

MT1 / MT2:  Konferenz beenden

¹ Das interne Telefonieren ist nur mit mindestens zwei Mobilteilen möglich  "Verpackungsinhalt prüfen" auf Seite 5.

Telefonieren

Einstellen der Basis-Klingellautstärke

Die folgende Einstellung nehmen Sie an der Basis vor.



BASE RINGER IS 0, 1, 2, 3, 4, 5



Einstellung ändern

Einstellen der Hörerlautstärke

Sie können während eines Gesprächs die Lautstärke in 5 Stufen anpassen.



Gewünschte Lautstärke auswählen

Hörverstärker

Sie können neben den 5 Lautstärkestufen noch weitere Hörverstärkungen auswählen
☞ Kapitel 5. Aktivieren Sie die entsprechende Verstärkung, um diese nutzen zu können.

HÖRVERSTÄRK.	Funktion
AUS	nur Lautstärke 1-5 wählbar
AN, LEISE	zusätzlich niedrige Verstärkung wählbar
AN, MITTEL	zusätzlich niedrige und mittlere Verstärkung wählbar
AN, LAUT	zusätzlich niedrige, mittlere und laute Verstärkung wählbar
AUTOMATISCH	Durch 2 Sek. Drücken, wird die lauteste Verstärkung automatisch gewählt

Anzeige der Gesprächsdauer

Während eines Gesprächs wird die Gesprächsdauer in Stunden, Minuten und Sekunden angezeigt.

Freisprechen

Nutzen Sie diese Funktion, um den Gesprächspartner über den Lautsprecher zu hören.



Freisprechen einschalten



Freisprechen ausschalten

Mikrofon im Mobilteil stummschalten

Sie können während eines Telefongesprächs das Mikrofon des Mobilteils aus- und einschalten.



Mikrofon ausschalten (stummschalten)



Mikrofon einschalten

Tastensperre

Die Tastensperre soll verhindern, dass versehentlich Funktionen ausgelöst werden.

Erweitern des Telefonsystems

3 Sek. 

Tastensperre einschalten





Bei eingeschalteter Tastensperre können eingehende Anrufe wie gewohnt angenommen werden.

3 Sek. 



Tastensperre ausschalten

Mobilteil suchen (Paging)

Wenn Sie Ihr Mobilteil verlegt haben, können Sie es über einen Suchton leicht wiederfinden.

An der Basis , 

Suchton starten

 oder 

Suchton beenden

9 Erweitern des Telefonsystems

Über den international genormten **GAP**¹-Standard ist die Kompatibilität von Mobilteilen und Basisstationen unterschiedlicher Hersteller geregelt. So ist es möglich, **SWITEL**-Geräte und Geräte anderer Hersteller zusammen in ein Telefonsystem zu integrieren. Es ist jedoch möglich, dass einige Funktionen nicht zur Verfügung stehen.

Mehrere Mobilteile



Sie können insgesamt 5 Mobilteile an Ihre Basisstation anmelden.

Anmelden von Mobilteilen

Bevor Sie ein Mobilteil anmelden, müssen Sie die Basisstation in den Registriermodus setzen.

15 Sek. 

Registriermodus starten

Melden Sie nun das Mobilteil an  Kapitel 5. Benutzen Sie zur Anmeldung den aktuell eingestellten PIN-Code  Kapitel 5.

Nach dem Anmelden wird dem Mobilteil eine interne Rufnummer zugeteilt. Diese interne Rufnummer wird im Display angezeigt.



Um Mobilteile anderer Hersteller anzumelden, lesen Sie bitte deren Bedienungsanleitungen.

Abmelden von Mobilteilen



Sie können ein Mobilteil von einer Basisstation nur durch ein weiteres an dieser Basisstation angemeldetes Mobilteil abmelden.

Mobilteile werden über das Menü abgemeldet. Im Kapitel 5 finden Sie die Position im Menü.

¹ **GAP: Generic Access Profile** = Standard für das Zusammenwirken von Mobilteilen und Basisstationen unterschiedlicher Hersteller.

Besondere Funktionen

Mehrere Basisstationen

Sie können die Reichweite Ihres Mobilteils vergrößern, wenn Sie es an mehrere Basisstationen anmelden. Es kann gleichzeitig an 4 verschiedenen Basisstationen angemeldet sein. Jede Basisstation benötigt eine eigene Telefonsteckdose. Es können Anschlüsse mit derselben und auch mit unterschiedlichen Rufnummern sein.



Laufende Gespräche können nicht von einer zur anderen Basisstation übertragen werden.

10 Besondere Funktionen

Wahlverfahren

Sie können Ihr Telefon sowohl an den analogen Vermittlungsstellen (Impuls-Wahlverfahren) als auch an den neuen digitalen Vermittlungsstellen (Ton-Wahlverfahren) betreiben. Das Wahlverfahren wird über das Menü eingestellt. Im Kapitel 5 finden Sie die Position im Menü.

11 Nebenstellenanlagen / Zusatzdienste

R-Taste an Nebenstellenanlagen

Ist Ihr Telefon an einer Nebenstellenanlage angeschlossen, können Sie über die **R-Taste** Funktionen, wie z. B. Anrufe weiterleiten und automatischen Rückruf, nutzen. Lesen Sie bitte in der Bedienungsanleitung Ihrer Nebenstellenanlage, welche Flash-Zeit Sie zur Nutzung dieser Funktionen einstellen müssen. Ob Ihr Telefon an Ihrer Nebenstellenanlage einwandfrei funktioniert, erfahren Sie bei dem Händler, bei dem die Anlage gekauft wurde. Die Flash-Zeit stellen Sie über das Menü ein. Im Kapitel 5 finden Sie die Position im Menü.

Wahlpause

Bei Nebenstellenanlagen ist es erforderlich, eine Amtskennzahl vorzuwählen, um ein Freizeichen zu bekommen. Bei wenigen älteren Nebenstellenanlagen dauert es einige Zeit, bis das Freizeichen zu hören ist. Für diese Nebenstellenanlagen kann nach der Amtskennzahl eine Wahlpause eingefügt werden, um direkt weiterwählen zu können, ohne das Freizeichen abzuwarten. Die Wahlpause fügen Sie durch Drücken und 3 Sek. halten der Taste **P** ein.

Nach der Amtskennzahl erfolgt die Wahl der eigentlichen Rufnummer nach einer bestimmten Zeit.



Die Wahlpause kann auch bei der Eingabe von Rufnummern im Telefonbuch gespeichert werden.

Anrufbeantworter

R-Taste und Zusatzdienste

Ihr Telefon unterstützt Zusatzdienste Ihres Netzbetreibers, wie z. B. Makeln, Anklopfen und Konferenz. Über die **R-Taste** können Sie diese Zusatzdienste nutzen. Bitte fragen Sie Ihren Netzbetreiber, welche Flash-Zeit Sie zur Nutzung von Zusatzdiensten einstellen müssen. Zur Freischaltung von Zusatzdiensten wenden Sie sich bitte an Ihren Netzbetreiber. Die Flash-Zeit stellen Sie über das Menü ein. Im Kapitel 5 finden Sie die Position im Menü.

Rufnummernanzeige (CLIP¹)



Die Rufnummernanzeige ist ein Zusatzdienst Ihres Netzbetreibers. Fragen Sie Ihren Netzbetreiber nach weiteren Informationen.

Wenn diese Funktion an Ihrer Telefonleitung zur Verfügung steht, wird Ihnen bereits die Rufnummer des Anrufers angezeigt, wenn das Telefon klingelt. Hat der Anrufer das Übertragen seiner Rufnummer unterdrückt, wird eine entsprechende Meldung angezeigt. Die Rufnummer kann nicht angezeigt und somit auch nicht in der Anrufliste gespeichert werden.

Anrufbeantworter im Telefonnetz

Der Anrufbeantworter im Telefonnetz ist ein Zusatzdienst vieler Netzbetreiber. Wenn Ihr Netzbetreiber einen Anrufbeantworter im Telefonnetz für Sie bereitstellt, werden Sie mit einem Symbol über neue Nachrichten informiert (**VMWI**²). Über diese Funktion können Sie nur dann verfügen, wenn Ihr Netzbetreiber diesen Zusatzdienst anbietet. Bitte fragen Sie Ihren Netzbetreiber nach weiteren Informationen.

Sie können die Anzeige des Symbols für neue Nachrichten ausschalten.

Siehe Kapitel 5, VMWI OFF?.

12 Anrufbeantworter

Bedienung an der Basis



Ihr Anrufbeantworter verfügt über eine gesprochene Bedienung. Beachten Sie diese Anweisungen und Hinweise.

Spracheinstellung

Die Sprachausgabe des Anrufbeantworters ist Englisch.

Anrufbeantworter ein-/ausschalten



ANSWER ON / ANSWER OFF



Einstellung ändern

¹ **CLIP**: Calling Line Identification Presentation = Anzeige der Rufnummer eines Anrufers.

² **VMWI**: Visual Message Waiting Indication = Optische Anzeige neuer Nachrichten.

Anrufbeantworter

Maximale Aufnahmezeit

Die maximale Aufnahmezeit beträgt 19 Minuten. Ist die Speicherkapazität für neue Nachrichten erschöpft, wird kein Anruf mehr aufgezeichnet. Ist der Speicher voll, erscheint im Display ein "F".

Lautstärke einstellen

Sie können die Lautstärke in 8 Stufen einstellen.



Lautstärke einstellen (u 1-u8)

Verzögerung der Anrufannahme

Sie können zwischen 3 bis 6 Tonrufen wählen. Zusätzlich können Sie die gebührenfreie Vor-/Fernabfrage (TIME SAVER) verwenden. Mit dieser Vor-/Fernabfrage können Sie gebührenfrei feststellen, ob sich neue Nachrichten auf Ihrem Anrufbeantworter befinden.

- Befinden sich neue Nachrichten auf Ihrem Anrufbeantworter, wird Ihr Anruf spätestens nach 3 Tonrufen angenommen.
- Befinden sich keine neuen Nachrichten auf Ihrem Anrufbeantworter, wird Ihr Anruf erst nach 5 Tonrufen angenommen. Legen Sie vor dem 5. Tonruf auf. So fallen keine Gebühren an.

Weitere Informationen über die Fernabfrage  Seite 28.

Verzögerung einstellen



RING DELAY IS SET TO 3/4/5/6/TIME SAVER



Einstellung ändern

Anruf übernehmen

Wenn der Anrufbeantworter bereits einen Anruf entgegengenommen hat, können Sie diesen übernehmen. Die Aufzeichnung der Nachricht wird in diesem Fall abgebrochen.



Anruf übernehmen

Antwortmodi

Ihr Anrufbeantworter stellt Ihnen zwei Antwortmodi zur Verfügung. Nach dem Antworttext ANNOUNCE ONLY IS OFF kann eine Nachricht hinterlassen werden. Beim Antworttext ANNOUNCE ONLY IS ON handelt es sich um eine Nur-Ansage, nach der keine Nachricht hinterlassen werden kann.

Antwortmodus wählen



ANNOUNCE ONLY IS OFF /
ANNOUNCE ONLY IS ON



Einstellung ändern

Anrufbeantworter

Ansage einstellen

Ihr Anrufbeantworter stellt Ihnen einen voreingestellten Ansagetext zur Verfügung. Sie können den Ansagetext durch eigene Texte ersetzen. Ist der Speicher des Anrufbeantworters voll, wird automatisch der Ansagetext ANNOUNCE ONLY IS ON wiedergegeben.

Mit den folgenden Einstellungen ändern Sie den Ansagetext der Antwortmodi.

Ansagen abspielen

 ,  /  ANNOUNCEMENT IS...

Ansagen aufzeichnen

 ,  /  ANNOUNCEMENT IS...

 Aufzeichnung starten

Sprechen Sie nun den von Ihnen gewünschten Text klar und deutlich in das Mikrofon.

 Aufzeichnung beenden

Nach Beendigung wird Ihre Ansage laut wiederholt.



Standardansagetext wieder aktivieren

 ,  /  ANNOUNCEMENT IS...

 Standardansagetext wiederherstellen

Alarm bei aufgezeichneten Nachrichten

Wurde eine neue Nachricht oder ein Memo aufgezeichnet, ertönt alle 10 Sekunden ein Signalton.

 ,  /  MESSAGE ALERT IS OFF / MESSAGE ALERT IS ON

 Einstellung ändern

Aufgezeichnete Nachrichten abhören / löschen

Nachrichten abhören

Die aufgezeichneten Nachrichten werden in der Reihenfolge wiedergegeben, in der sie eingegangen sind. Neue Nachrichten werden zuerst wiedergegeben. Der Wochentag und die Uhrzeit werden vor dem Abspielen der jeweiligen Nachricht genannt.

 Nachrichten abhören

 Wiedergabe stoppen

 Nachricht wiederholen

2x  Vorherige Nachricht

 Nächste Nachricht

Eine Nachricht löschen

Anrufbeantworter



Zu löschende Nachricht abhören



Während der Wiedergabe löschen



Gelöschte Nachrichten können nicht wiederhergestellt werden!

Memo aufzeichnen

Ein Memo ist eine Mitteilung, die wie eine eingegangene Nachricht abgehört werden kann.



MESSAGE RECORDING



Memo aufzeichnen

Sprechen Sie nun den von Ihnen gewünschten Text klar und deutlich in das Mikrofon.



Aufzeichnung beenden

Fernabfrage

Sie können Ihren Anrufbeantworter anrufen, um Nachrichten abzuhören und weitere Funktionen durchzuführen. Voraussetzung dafür ist ein Telefon mit Tonwahlfunktion.

PIN-Code für die Fernabfrage

Der PIN-Code ist werkseitig auf "1234" eingestellt. Es wird empfohlen, den PIN-Code zu ändern.

PIN-Code ändern



REMOTE ACCESS CODE IS 1234



Änderung einleiten

Ziffer für die erste Position wählen.



Ziffer wählen



Bestätigen

Für die Einstellung der zweiten, dritten und vierten Position verfahren Sie identisch.

Fernabfrage starten



Eigene Rufnummer wählen



Während der Ansage PIN-Code eingeben

Jetzt haben Sie die Möglichkeit, weitere Funktionen durchzuführen ➔ Tabelle Tastenfunktionen der Fernabfrage.

Ferneinschalten des Anrufbeantworters



Eigene Rufnummer wählen



Haben Sie vergessen, Ihren Anrufbeantworter einzuschalten, wird Ihr Anruf erst nach 17 Tonrufen angenommen.

Anrufbeantworter



Während der Ansage PIN-Code eingeben

4

Anrufbeantworter einschalten

Jetzt haben Sie die Möglichkeit, weitere Funktionen durchzuführen.

Tastenfunktionen der Fernabfrage



Die Fernabfrage wird automatisch abgebrochen, wenn innerhalb von 10 Sekunden keine Eingabe erfolgt.

Die folgende Tabelle verschafft Ihnen eine Übersicht über die jeweiligen Funktionen der einzelnen Tasten.

Taste	Funktionen
1	Laufende Nachricht wiederholen
2x 1	Vorherige Nachricht abhören
2	Nachrichtenwiedergabe starten / stoppen
3	Nächste Nachricht abhören
4	Anrufbeantworter ein-/ausschalten
7	Hilfe-Menü anhören
0	Nachricht während der Wiedergabe löschen
#	Fernabfrage beenden

Anrufbeantworterdisplay

Das Display des Anrufbeantworters zeigt den Status des Geräts an.

--	Anrufbeantworter ausgeschaltet
00-XX	Konstant: Anrufbeantworter eingeschaltet, Anzahl gespeicherter Nachrichten Blinkend: Neue Nachrichten
≡≡	Erscheint, wenn eine Nachricht / Ansage aufgezeichnet wird
-F	Speicher voll
rR	Fernabfrage

Falls es Probleme gibt

13 Falls es Probleme gibt

Service-Hotline

Haben Sie Probleme mit Ihrem Telefon, kontrollieren Sie zuerst die folgenden Hinweise. Bei technischen Problemen können Sie sich an unsere Service-Hotline unter Tel. 0900 00 1675 innerhalb der Schweiz (Kosten Swisscom bei Drucklegung: CHF 2.60/min) wenden. Bei Garantieansprüchen wenden Sie sich an Ihren Fachhändler. Die Garantiezeit beträgt 2 Jahre.

Fragen und Antworten

Fragen	Antworten
Kein Telefongespräch möglich	<ul style="list-style-type: none">- Das Telefon ist nicht korrekt angeschlossen oder gestört. Verwenden Sie nur das mitgelieferte Telefonanschlusskabel.- Testen Sie mit einem anderen Telefon, ob Ihr Telefonanschluss in Ordnung ist.- Das Netzteil ist nicht eingesteckt oder es liegt ein totaler Stromausfall vor.- Die aufladbaren Akkus sind leer oder defekt.- Sie haben sich zu weit von der Basisstation entfernt.- Wahlverfahren falsch eingestellt ☞ Seite 15.
Keine Verbindung zur Basisstation möglich	<ul style="list-style-type: none">- Prüfen Sie, ob Sie sich mit dem richtigen PIN-Code an der Basisstation angemeldet haben ☞ Seite 15.
Verbindung abgehackt, fällt aus	<ul style="list-style-type: none">- Sie haben sich zu weit von der Basisstation entfernt.- Falscher Aufstellungsort der Basisstation.
Das System reagiert nicht mehr	<ul style="list-style-type: none">- Setzen Sie alle Funktionen in den Werkszustand zurück ☞ Seite 14/15.- Ziehen Sie kurzzeitig das Netzteil aus der Steckdose.

Technische Eigenschaften

Die Akkus sind in kürzester Zeit leer	<ul style="list-style-type: none">- Die Akkus sind leer oder defekt.- Stellen Sie das Mobilteil richtig auf die Basisstation. Reinigen Sie die Kontaktflächen am Mobilteil und an der Basisstation mit einem weichen trockenen Tuch.- Stellen Sie das Mobilteil für 16 Stunden in die Basisstation.
Die Rufnummernanzeige (CLIP) funktioniert nicht	<ul style="list-style-type: none">- Die Rufnummernanzeige ist ein Zusatzdienst Ihres Netzbetreibers. Bitte fragen Sie Ihren Netzbetreiber nach weiteren Informationen.- Der Anrufer hat das Übertragen seiner Rufnummer unterdrückt.
Der Anrufbeantworter nimmt keine Nachrichten/Memos auf	<ul style="list-style-type: none">- Prüfen Sie, ob der Speicher des Anrufbeantworters voll ist. Löschen Sie ggf. Nachrichten aus dem Speicher ☞ Seite 28.
Sie können keine Fernabfrage durchführen	<ul style="list-style-type: none">- Prüfen Sie, ob Sie den richtigen Sicherheitsscode für die Fernabfrage benutzen ☞ Seite 28.- Das Telefon, das Sie für die Fernabfrage nutzen, muss auf Ton-Wahlverfahren eingestellt sein.

14 Technische Eigenschaften

Technische Daten

Merkmal	Wert
Standard	DECT ¹ -GAP ²
Stromversorgung (Basisstation)	Eingang: 220/230 V, 50 Hz Ausgang: 7,5 V, 320 mA
Stromversorgung (Ladestation)	Eingang: 220/230 V, 50 Hz Ausgang: 6 V, 150 mA

¹ **DECT**: Digital Enhanced Cordless Telecommunication = Standard für kabellose Telefone.

² **GAP**: Generic Access Profile = Standard für das Zusammenwirken von Mobilteilen und Basisstationen unterschiedlicher Hersteller.

Technische Eigenschaften

Reichweite	Außen: ca. 300 m Innen: ca. 50 m
Stand-by-Zeit	Bis zu 100 h
Max. Gesprächsdauer	Bis zu 10 h
Aufladbare Akkus	2 x AAA NiMH 1.2 V
Wahlverfahren	Ton-Wahlverfahren Impuls-Wahlverfahren
Zulässige Umgebungstemperatur	10 °C bis 30 °C
Zulässige relative Luftfeuchtigkeit	20 % bis 75 %
Flash-Funktion	100 ms, 300 ms, 600 ms

Werkseinstellungen

Mobilteil

Die Werkseinstellungen werden über das Menü wiederhergestellt. Auf Seite 14 finden Sie die Position im Menü.

SPRACHE = DEUTSCH	TELEFONBUCH = leer
ANRUFLISTE = leer	WAHLWIEDERH. = leer
M1, M2 = leer	ALARM 1/2 = AUS
RUFTON EXT. = 1	RUFTON INT. = 2
LAUTSTÄRKE = 3	AUTO ANNAHME = AN
HÖRVERSTÄRK. = AUTOMATISCH	
BELEUCHTUNGS EINSTELLUNG = 10 Sek.	

Basisstation

Die Werkseinstellungen werden über das Menü wiederhergestellt. Auf Seite 15 finden Sie die Position im Menü.

RUFTÖNE = 2	LAUTSTÄRKE = 1
WAHLVERFAHR. = TONWAHL	PIN = 0000

Pflegehinweise / Garantie

Konformitätserklärung

Dieses Gerät erfüllt die Anforderungen der EU-Richtlinie:

1999/5/EG Richtlinie über Funkanlagen und Telekommunikationsendeinrichtungen und die gegenseitige Anerkennung ihrer Konformität. Die Konformität mit der o. a. Richtlinie wird durch das CE-Zeichen auf dem Gerät bestätigt.



Für die komplette Konformitätserklärung nutzen Sie bitte den kostenlosen Download von unserer Website www.switel.com.

15 Pflegehinweise / Garantie

Pflegehinweise

- Reinigen Sie die Gehäuseoberflächen mit einem weichen und fusselreien Tuch.
- Verwenden Sie keine Reinigungs- oder Lösungsmittel.

Garantie

SWITEL - Geräte werden nach den modernsten Produktionsverfahren hergestellt und geprüft. Ausgesuchte Materialien und hoch entwickelte Technologien sorgen für einwandfreie Funktion und lange Lebensdauer. Ein Garantiefall liegt nicht vor, wenn die Ursache einer Fehlfunktion des Geräts bei dem Telefonnetzbetreiber oder einer eventuell zwischengeschalteten Nebenstellenanlage liegt. Die Garantie gilt nicht für die in den Produkten verwendeten Batterien, Akkus oder Akkupacks. Die Garantiezeit beträgt 24 Monate, gerechnet vom Tage des Kaufs.

Innerhalb der Garantiezeit werden alle Mängel, die auf Material- oder Herstellungsfehler zurückzuführen sind, kostenlos beseitigt. Der Garantieanspruch erlischt bei Eingriffen durch den Käufer oder durch Dritte. Schäden, die durch unsachgemäße Behandlung oder Bedienung, natürliche Abnutzung, durch falsches Aufstellen oder Aufbewahren, durch unsachgemäßen Anschluss oder Installation sowie durch höhere Gewalt oder sonstige äußere Einflüsse entstehen, fallen nicht unter die Garantieleistung. Wir behalten uns vor, bei Reklamationen die defekten Teile auszubessern, zu ersetzen oder das Gerät auszutauschen. Ausgetauschte Teile oder ausgetauschte Geräte gehen in unser Eigentum über. Schadenersatzansprüche sind ausgeschlossen, soweit sie nicht auf Vorsatz oder grober Fahrlässigkeit des Herstellers beruhen.

Sollte Ihr Gerät dennoch einen Defekt innerhalb der Garantiezeit aufweisen, wenden Sie sich bitte unter Vorlage Ihrer Kaufquittung ausschließlich an das Geschäft, in dem Sie Ihr SWITEL - Gerät gekauft haben. Alle Gewährleistungsansprüche nach diesen Bestimmungen sind ausschließlich gegenüber Ihrem Fachhändler geltend zu machen. Nach Ablauf von zwei Jahren nach Kauf und Übergabe unserer Produkte können Gewährleistungsrechte nicht mehr geltend gemacht werden.

Stichwortverzeichnis

16 Stichwortverzeichnis

A

Abhören, 27
Abmelden, 15, 23
Abspielen, 27
Akkuladezustand, 7
Akkus einlegen, 6
Alarm, 27
Ändern, 17
Anmelden, 15, 23
Anrufannahme, 7, 20
Anrufbeantworter, 25
Anrufbeantworter im Telefonnetz, 25
Anrufen, 20
Anrufliste, 12, 18
Anrufübernahme, 26
Ansage einstellen, 27
Ansagen, 27
Antwortmodus wählen, 26
Aufladen, 7
Auflegen, 20
Aufzeichnen, 27
Ausschalten, 25

B

Basisstation, 5, 24
Bedienelemente, 8
Bedienung, 9
Bedienung an der Basis, 25

C

CLIP, 25

D

Datum, 7
Direktwahl, 18, 21
Display, 10, 29
Displaymeldungen, 18
Displaysprache, 7
Displaysymbole, 10

E

ECO-Mode, 7
Einschalten, 25
Erstellen, 11, 16
Erweiterung, 23

F

Fehlerbehebung, 30
Fernabfrage, 28
Fern einschalten, 28
Fragen und Antworten, 30
Freisprechen, 22
Funktionen, 24

G

Garantie, 33
Gebührensparer, 26
Gespräch beenden, 20
Gesprächsdauer, 22
Gesprächsweiterleitung, 21

H

Hauptmenü, 12
Headsetanschluss, 8
Hörerlautstärke, 22
Hörverstärker, 22

Stichwortverzeichnis

I

Impuls-Wahlverfahren, 15, 24
Inbetriebnahme, 5
Interngespräche, 21

K

Klingellautstärke, 22
Konferenzgespräche, 21
Konformitätserklärung, 33

L

Ladestation, 6
Lautstärke, 26
Löschen, 17, 19, 27

M

Maximale Aufnahmezeit, 26
Meldungen, 18
Memo aufzeichnen, 28
Menüstruktur, 12
Mikrofonstummuschaltung, 22
Mobilteil, 23

N

Nachrichten, 27
Nachrichten löschen, 27
Namenseingabe, 16
Nebenstellenanlagen, 24

P

Paging, 23
Pflegehinweise, 33
PIN-Code, 28
PIN-Code ändern, 28
Probleme, 30

R

R-Taste, 24, 25
Rückruf, 20
Rufnummernanzeige, 18, 25

S

Schreibweisen, 9
Service-Hotline, 30
Sicherheitshinweise, 4
Speichern, 11, 16, 19
Sprache, 25
Stand-by-Modus, 10
Strahlungsreduzierung, 7
Stummuschaltung, 22
Suchen, 23
Symbole, 10

T

Tastenfunktionen, 29
Tastensperre, 22
Technische Daten, 31
Telefonbuch, 12, 16, 20
Telefonbucheinträge, 11, 16
Telefonieren, 20
Texteingabe, 16
Ton-Wahlverfahren, 15, 24
Tonrufmelodie, 13, 15

U

Uhrzeit, 7

Stichwortverzeichnis

V

Verpackungsinhalt, 5

Verzögerung, 26

VMWI, 25

W

Wählen, 20

Wahlpause, 24

Wahlverfahren, 15, 24

Wahlwiederholung, 13, 20

Wecker, 13

Weiterleitung, 21

Werkseinstellungen, 14, 15, 32

Z

Zusatzdienste, 24

Table des matières

1	Consignes de sécurité	38
2	Mettre le téléphone en service	39
3	Éléments de manipulation	42
4	Introduction	43
5	Structure du menu	46
6	Répertoire	50
7	Liste d'appels	52
8	Téléphoner	54
9	Élargissement du système téléphonique . .	57
10	Fonctions particulières	58
11	Installations PABX / Services confort	58
12	Répondeur	59
13	En cas de problèmes	64
14	Caractéristiques techniques	65
15	Remarques d'entretien / Garantie	67
16	Index	68

Consignes de sécurité

1 Consignes de sécurité

Lisez très attentivement ce mode d'emploi.

Utilisation conforme aux prescriptions

Ce téléphone convient pour téléphoner à l'intérieur d'un réseau téléphonique. Tout autre utilisation est considérée comme non conforme à l'usage. Des modifications ou changements effectués d'un propre gré ne sont pas autorisés. N'ouvrez en aucun cas l'appareil et n'effectuez aucun essai de réparation vous-même.

Lieu d'installation

Évitez les nuisances causées par la fumée, la poussière, les vibrations, les produits chimiques, l'humidité, la grande chaleur ou un ensoleillement direct.

Ne vous servez pas du combiné dans des endroits exposés aux explosions.

Bloc secteur



Attention : N'utilisez que le bloc secteur fourni avec l'appareil, d'autres pouvant endommager votre téléphone. Vous ne devez pas bloquer l'accès au bloc secteur par des meubles ou d'autres objets.

Piles rechargeables



Attention : Ne jetez jamais les piles rechargeables dans le feu. N'utilisez que des piles rechargeables du même type ! Observez une polarisation correcte ! Il y a risque d'explosion lors de leur chargement si la polarisation est incorrecte.

Panne de courant

En cas de panne de courant, il n'est pas possible de téléphoner avec cet appareil. Pour les cas d'urgence, ayez à votre disposition un téléphone à fil fonctionnant sans alimentation externe en courant.

Appareils médicaux



Attention : N'utilisez pas ce téléphone à proximité d'appareils médicaux. Son influence ne peut pas être entièrement exclue.

Compatible avec les prothèses auditives

Ce téléphone est compatible avec la plupart des prothèses auditives en vente sur le marché. Cependant, un fonctionnement irréprochable ne peut être garanti pour chacune d'entre elles.

Les téléphones **DECT**¹ peuvent causer un bourdonnement désagréable dans les prothèses auditives.

¹ **DECT**: Digital Enhanced Cordless Telecommunication = Standard pour les téléphones sans fil.

Mettre le téléphone en service

Élimination

Si vous ne voulez plus vous servir de votre appareil, veuillez l'apporter au centre de collecte de l'organisme d'élimination des déchets de votre commune (par ex. centre de recyclage). L'icône ci-contre signifie que vous ne devez en aucun cas jeter votre appareil dans les ordures ménagères !

D'après la loi relative aux appareils électriques et électroniques, les propriétaires d'appareils usagés sont tenus de mettre tous les **appareils électriques et électroniques** usagés dans un collecteur séparé. Éliminez les

pile rechargeables auprès d'un revendeur spécialisé ainsi que dans des centres de collecte qui tiennent à votre disposition les collecteurs appropriés correspondants.

Éliminez les **fournitures d'emballage** conformément au règlement local.



2 Mettre le téléphone en service

Remarques concernant la sécurité



Attention : Avant de mettre votre appareil en service, lisez impérativement les consignes de sécurité mentionnées au chapitre 1.

Vérifier le contenu de l'emballage

Les éléments suivants font partie de la livraison :

Contenu	Modèle DCT627x ¹			
	6271	6272	6273	6274
Base avec bloc secteur	1	1	1	1
Chargeur avec bloc secteur	-	1	2	3
Combiné	1	2	3	4
Câble de raccordement téléphonique	1	1	1	1
Piles rechargeables	2	4	6	8
Mode d'emploi	1	1	1	1

¹ À l'adresse www.switel.com, vous apprendrez si ce téléphone/kit téléphonique est déjà disponible à la vente.

Mettre le téléphone en service

Raccorder la base



Attention : Posez la base à une distance minimum d'1 m par rapport à d'autres appareils électroniques, une distance inférieure pouvant provoquer des interactions.

Raccordez la base comme représenté sur le croquis. Pour des raisons de sécurité, n'utilisez que le bloc secteur fourni avec l'appareil ainsi que le câble de raccordement téléphonique ci-joint.

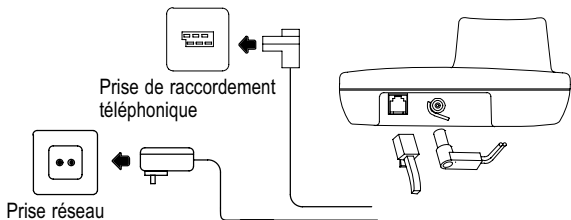

Pour la base, utilisez le bloc secteur portant le n° KG2B-075-0320D et les données de sortie 7.5 V, 320 mA.

Raccorder le chargeur¹

Raccordez le chargeur tel que représenté sur le croquis. Pour des raisons de sécurité, n'utilisez que le bloc secteur fourni avec l'appareil.

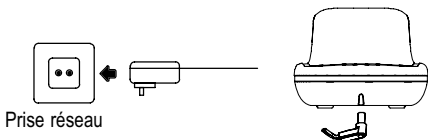

Pour le chargeur, utilisez le bloc secteur portant les données de sortie 6 V, 150 mA.

¹ Valable uniquement pour les kits téléphoniques équipés d'au moins deux combinés ➤ "Vérifier le contenu de l'emballage" à la page 39.

Mettre le téléphone en service

Mettre en place les piles rechargeables

Insérez les piles rechargeables dans le compartiment à piles ouvert. N'utilisez que des piles rechargeables de type AAA NiMH 1,2 V. Observez une polarisation correcte ! Fermez le compartiment à piles.

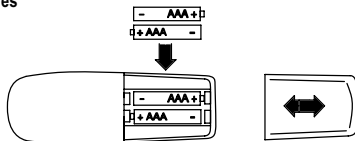

Recharger les piles rechargeables



Lors de la première mise en service, laissez le combiné pendant **au moins 16 heures** sur la base / le chargeur.

[Si vous avez placé le combiné correctement sur la base / le chargeur, un signal indicateur se fait entendre.][Si vous avez placé le combiné correctement sur la base / le chargeur, le voyant de contrôle de charge s'allume.] Le combiné chauffe lors du chargement. C'est normal et inoffensif. Ne chargez pas le combiné avec des chargeurs d'autres fabricants. Le **niveau actuel de chargement des piles rechargeables** est affiché à l'écran :



Plein



Moyen



Faible



Vide

Paramétrer la langue de l'écran

Sélectionnez la langue correspondante (voir également "Structure de menu"):

(☞) > MOBILTEIL > SPRACHE >...

(☞) > RÉGL. TÉL. > LANGUE >...

Les langues allemand, français, italien et anglais sont disponibles.

Régler l'heure et la date du combiné

Vous réglez l'heure et la date via le menu. La page 47 vous donnera la position dans le menu.

Prise d'appel automatique

Si vous avez activé cette fonction, l'appel sera automatiquement pris lorsque vous retirerez le combiné de la base. La prise d'appel automatique s'active ou se désactive via le menu. La page 48 vous donnera la position dans le menu.

Installations PABX

La page 58 vous donnera de plus amples informations au cas où vous désireriez raccorder votre téléphone à une installation PABX.

Éléments de manipulation

Réduction du rayonnement (mode ÉCO)

Le rayonnement est, comparé aux téléphones sans fil DECT standard, considérablement réduit en mode veille quand le combiné repose sur la base.

En mode de communication, le rayonnement est réduit en fonction de l'éloignement du combiné par rapport à la base.



3 Éléments de manipulation

Dans ce mode d'emploi, les touches de votre téléphone seront représentées par la suite par des icônes encadrées standardisées. Il peut donc y avoir de légères différences entre les icônes des touches de votre téléphone et celles des touches utilisées ici.

Combiné

- 1 Haut-parleur
- 2 Écran à CL
- 3 Touche OK / de menu
- 4 Touche de sélection rapide M2
- 5 Raccord du casque
- 6 Touche R / d'effacement
- 7 Touche mains-libres
- 8 Pavé numérique
- 9 Touche # / Verrouillage du clavier
- 10 Microphone
- 11 Touche de pause
- 12 Touche * / Communications internes
- 13 Touche de communication / de rattachement
- 14 Touche fléchée en bas / Liste d'appels
- 15 Touche de sélection rapide M1
- 16 Touche fléchée en haut / Répétition automatique des derniers numéros
- 17 Diode électroluminescente

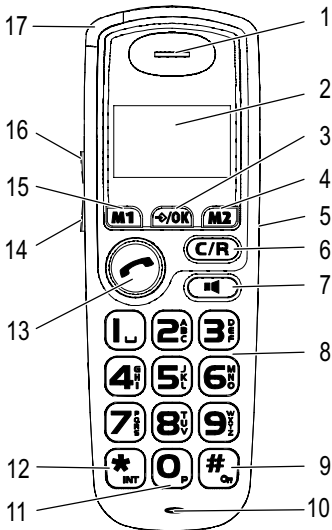

Introduction

Raccord du casque

Sur le côté droit du combiné, vous trouverez une possibilité de raccorder un casque. Utilisez un casque avec une fiche à jack stéréo de 2,5 mm. Nous ne pouvons pas garantir un fonctionnement parfait.

Base

- 1 Contacts de chargement
- 2 Haut-parleur
- 3 Écran LC
- 4 Volume sonore +
- 5 Volume sonore -
- 6 Menu en avant/
Message suivant
- 7 Reproduction / Arrêt /
Confirmer /
Terminer le réglage
- 8 Menu en arrière/
Message précédent
- 9 Effacer le message / l'annonce
- 10 Modifier le menu / le réglage
- 11 Touche de paging

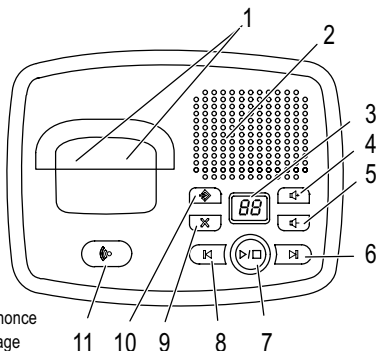





4 Introduction

Dans ce chapitre, vous trouverez des informations de base vous expliquant comment vous servir du mode d'emploi et du téléphone.









Mode de représentation dans le mode d'emploi

Visualisation	Description
	Visualisation des touches
	Appuyer brièvement sur la touche représentée
2 sec.	Appuyer 2 secondes sur la touche représentée
	Saisir des chiffres ou des lettres

Introduction

	Le combiné sonne
	Prendre le combiné de la base
	Poser le combiné sur la base
	Visualisation des textes de l'écran
	Visualisation des icônes de l'écran

Icônes et textes à l'écran du combiné

Icône	Description
	Constant : affichage de la capacité des piles. Clignotant : rechargez les piles rechargeables. Segments continus : les piles rechargeables se rechargent ☞ page 41.
1	Numéro d'appel interne du combiné ☞ page 57
12--59	Affichage de l'heure ☞ page 47
	Vous passez une communication ☞ page 54.
	Vous vous trouvez dans la liste d'appels. De nouveaux appels se trouvent dans la liste d'appels ☞ page 52.
	La sonnerie est débranchée ☞ page 47.
	Le mode mains-libres est activé ☞ page 56.
	Le verrouillage du clavier est activé ☞ page 57.
	La fonction d'alarme est branchée.
MESSAGE EN AT- TENTE	Répondeur dans le réseau téléphonique. Services confort VMWI ¹ de votre opérateur ☞ page 59.
	La liaison avec la base est bonne.

¹ **VMWI**: Visual Message Waiting Indication = Affichage optique de nouveaux messages.













Introduction

Mode veille

Toutes les descriptions dans ce mode d'emploi partent du principe que le combiné se trouve en mode veille. Le combiné se trouve en mode veille quand aucune communication n'a lieu et qu'aucun menu n'est ouvert. Appuyez, le cas échéant, plusieurs fois sur la touche  pour accéder au mode veille.

Navigation dans le menu

Vous pouvez accéder à toutes les fonctions via différents menus. La structure de menu vous montre comment accéder à la fonction désirée  page46.









	Ouvrir le menu principal
 ou 	Sélectionner le sous-menu désiré
	Ouvrir le sous-menu
 ou 	Sélectionner la fonction désirée
	Ouvrir la fonction
 ou 	Sélectionner le réglage désiré
	Saisir des chiffres ou des lettres via le pavé numérique
	Confirmer les entrées
	Reculer d'une position
Plusieurs fois, le cas échéant 	Annuler les opérations de programmation et de sauvegarde et retourner en mode veille



Chaque opération est automatiquement annulée si vous n'effectuez pas de saisie dans les 15 secondes.

Créer des enregistrements dans le répertoire - exemple

L'exemple **Créer des enregistrements du répertoire** vous explique ici comment naviguer dans les menus et effectuer des paramétrages. Pour tous les paramétrages, procédez comme dans cet exemple.

	Ouvrir le menu principal
RÉPERTOIRE 	Ouvrir le répertoire
	Sauter la sélection d'enregistrements
NOUVELLE ENTRÉE 	Sélectionner le sous-menu et confirmer
 	Saisir le nom (max. 12 caractères) et confirmer
 	Saisir le numéro d'appel (max. 24 chiffres) et confirmer

Structure du menu

5 Structure du menu

Menu principal

Vous parvenez au menu principal en appuyant sur la touche . Ensuite, sélectionnez un enregistrement à l'aide des touches ou et confirmez votre sélection avec la touche .

Pour d'autres informations relatives au menu et à la manipulation chapitre 4.

RÉPERTOIRE, / Sélectionner l'enregistrement, Sauter

NOUVELLE ENTRÉE	NOM ¹	NUMÉRO
MODIFIER	NOM	NUMÉRO
SUPPRIMER MÉMOIRE	CONFIRMER?	
SUPPR. TOUT	CONFIRMER?	

JRNAL APPELS², / Sélectionner l'enregistrement, Sauter

ENREGISTRER RÉPERTOIRE	NOM	NUMÉRO
SUPPRIMER MÉMOIRE	CONFIRMER?	
SUPPR. TOUT	CONFIRMER?	

¹ Des lettres sont gravées sur les touches numériques. En appuyant plusieurs fois sur la touche adéquate, vous pouvez saisir des lettres, des chiffres et des symboles.

² L' affichage du numéro d'appel (CLIP³) est nécessaire pour l'affichage et la sauvegarde de numéros d'appel dans les listes d'appels. L'affichage du numéro d'appel est un service confort de votre opérateur. Veuillez lui demander de plus amples informations. Pour d'autres informations sur l'affichage du numéro d'appel page 52.

³ **CLIP**: Calling Line Identification Presentation = Affichage du numéro d'appel d'un correspondant.

Structure du menu

RECOMPOSER, /↓ Sélectionner l'enregistrement, Sauter

ENREGISTRER RÉPÉ- TOIRE	NOM	NUMÉRO
SUPPRIMER MÉMOIRE	CONFIRMER?	
SUPPR. TOUT	CONFIRMER?	



ALARMES

ALARME 1	EFFACER		
	RÉGLER	HEURE	CONFIRMER?
ALARME 2	EFFACER		
	RÉGLER	HEURE	CONFIRMER?

RÉGL. TÉL.

MÉLODIE APPEL	MÉLODIE EXTERNE	MÉLODIE 1-10
	MÉLODIE INTERNE	MÉLODIE 1-10
VOLUME SONNERIE	VOLUME 1-5, OFF	
RÉGLAGE DATE/HEURE	DATE/HEURE	DATE ↘
		↘ CONFIRMER?
		HEURE ↘
		↘ CONFIRMER?
	FORMAT DATE/HEURE	DATE ↘
		↘ JJ/MM
		↘ MM/JJ



Structure du menu

↵		HEURE  ↵
		↵ 12 HEURES
		↵ 24 HEURES
MODE BOOST	ON	BAS
		MOYEN
		ÉLEVÉ
	AUTO	
	OFF	
TON. TOUCHES	ON/OFF	
CONTRASTE ÉCRAN	NIVEAU 1-8	
NOM DE COMBINÉ		
RÉGLER RÉTROÉCL.	5-30 SECONDES	
AUTO TALK	ON/OFF	
LANGUE ¹		
DÉFAUT	CONFIRMER?	



¹Pour savoir quelles langues sont disponibles, voir  chapitre 2.

Structure du menu

RÉGL. BASE, PIN ENTRÉE ¹

MÉLODIE BASE	MÉLODIE 1-5	
VOLUME SONNERIE	VOLUME 1-5, OFF	
CHANGER PIN ¹	NOUVEAU PIN 	CONFIRM. PIN 
MODE NUM	TONALITÉ	
	IMPULSION	
TPS CLIGNTMT	COURT	
	MOYEN	
	LONG	
MESSAGE VOC. ²	MSG VOC OFF?	
DÉFAUT	CONFIRMER?	

ENREGISTREMENT

ENREGISTRER	PIN ENTRÉE 	
SÉLECT. BASE	BASE 1-4	
SUPPRIMER COMBINÉ	PIN ENTRÉE 	COMBINÉ 1-4
EFFACER BASE	BASE 1-4	

¹ Le code PIN est réglé en usine sur "0000".

² **VMWI**: Visual Message Waiting Indication = Affichage optique de nouveaux messages.

Répertoire

6 Répertoire

Vous pouvez enregistrer 100 numéros d'appel et le nom y afférant dans votre répertoire.

- Saisissez toujours les numéros d'appel avec l'indicatif afin que le téléphone puisse aussi attribuer les communications locales entrantes à un enregistrement du répertoire.
- Si la capacité de mémoire est épuisée, l'écran affiche le message suivant **MÉM. PLEINE** lors du prochain enregistrement. Pour créer de la place, vous devez tout d'abord effacer un autre enregistrement.
- Les enregistrements du répertoire sont rangés par ordre alphabétique.

Saisir le nom

Des lettres sont gravées sur les touches numériques. En appuyant plusieurs fois sur la touche adéquate, vous pouvez saisir des lettres, des chiffres et des symboles.

1	Entrer des espaces
C	Effacer
▲ ou ▼	Déplacer le curseur



Pour saisir deux fois la même lettre, appuyez sur la touche correspondante. Attendez que le curseur soit passé derrière la lettre. Puis tapez la lettre une nouvelle fois.

Créer des enregistrements dans le répertoire

	Ouvrir le menu principal
RÉPERTOIRE	Ouvrir le répertoire
	Sauter la sélection d'enregistrements
NOUVELLE ENTRÉE	Sélectionner le sous-menu et confirmer
	Saisir le nom (max. 12 caractères) et confirmer
	Saisir le numéro d'appel (max. 24 chiffres) et confirmer

Répertoire

Modifier des enregistrements du répertoire

<input type="button" value="↔"/>	Ouvrir le menu principal
<input type="text" value="RÉPERTOIRE"/> <input type="button" value="↔"/>	Ouvrir le répertoire
<input type="button" value="▲ ou ▼"/> <input type="button" value="↔"/>	Sélectionner l'enregistrement, confirmer
<input type="button" value="▲ ou ▼"/> <input type="text" value="MODIFIER"/> <input type="button" value="↔"/>	Sélectionner le sous-menu et confirmer
<input type="button" value="⌨"/> <input type="button" value="↔"/>	Modifier le nom et confirmer
<input type="button" value="⌨"/> <input type="button" value="↔"/>	Modifier le numéro d'appel et confirmer

Effacer les enregistrements du répertoire

Effacer un enregistrement

<input type="button" value="↔"/>	Ouvrir le menu principal
<input type="text" value="RÉPERTOIRE"/> <input type="button" value="↔"/>	Ouvrir le répertoire
<input type="button" value="▲ ou ▼"/> <input type="button" value="↔"/>	Sélectionner l'enregistrement, confirmer
<input type="button" value="▲ ou ▼"/> <input type="text" value="SUPPRIMER MÉMOIRE"/> <input type="button" value="↔"/>	Sélection le sous-menu et confirmer
<input type="text" value="CONFIRMER?"/> <input type="button" value="↔"/> ou <input type="button" value="C"/>	Confirmer l'effacement ou annuler l'opération

Effacer tous les enregistrements

<input type="button" value="↔"/>	Ouvrir le menu principal
<input type="text" value="RÉPERTOIRE"/> <input type="button" value="↔"/>	Ouvrir le répertoire
<input type="button" value="↔"/>	Sauter la sélection d'enregistrements
<input type="button" value="▲ ou ▼"/> <input type="text" value="SUPPR. TOUT"/> <input type="button" value="↔"/>	Sélectionner le sous-menu et confirmer
<input type="text" value="CONFIRMER?"/> <input type="button" value="↔"/> ou <input type="button" value="C"/>	Confirmer l'effacement ou annuler l'opération

Liste d'appels

Sélection directe

Vous pouvez enregistrer 1 numéro d'appel comme sélection directe sur chacune des touches **M1** et **M2**.

Enregistrer des numéros d'appel comme sélection directe

Saisissez un numéro ou sélectionnez un enregistrement à partir du répertoire, de la liste de répétition automatique des derniers numéros ou de la liste d'appels.

3 sec. **M1** ou **M2**

Sélection enregistrée sur la touche de sélection directe correspondante



Des enregistrements sur les touches de sélection directe ne peuvent pas être effacés mais seulement être écrasés.

7 Liste d'appels

Dans l'ensemble, 20 numéros d'appel sont enregistrés dans une liste d'appels.



L'affichage du numéro d'appel (**CLIP**¹) est un service confort de votre opérateur. Votre téléphone affiche les numéros d'appel à l'écran si votre opérateur offre ce service. Veuillez lui demander de plus amples informations.

Messages à l'écran :

INDISPONIBLE	Le numéro est reçu partiellement ou incorrectement.
LONGUE DIST.	L'information du numéro d'appel n'est pas disponible. Il pourrait s'agir d'une communication internationale.
SECRET	Le correspondant a bloqué la transmission de son numéro d'appel.

Faire afficher des numéros de la liste d'appels

,  ou 

Ouvrir la liste d'appel et sélectionner l'enregistrement

Le cas échéant, appuyez plusieurs fois sur la touche  pour passer à l'écran, de l'affichage "Nom" à "Numéro" et à "Heure d'entrée".

¹ **CLIP**: Calling Line Identification Presentation = Affichage du numéro d'appel d'un correspondant.

Liste d'appels

Sauvegarder dans le répertoire des numéros d'appel de la liste d'appels

Vous pouvez enregistrer un numéro d'appel dans le répertoire directement à partir de la liste d'appels.



Ouvrir la liste d'appel et sélectionner l'enregistrement



Ouvrir le menu

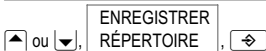

Sélectionner le sous-menu et confirmer



Saisir le nom (max. 12 caractères) et confirmer



Modifier le numéro d'appel et confirmer



Dès que le numéro a été enregistré avec un nom dans le répertoire, ce nom apparaît dans la liste d'appels.

Effacer des numéros de la liste d'appels

Effacer des numéros individuels



Ouvrir la liste d'appel et sélectionner l'enregistrement



Ouvrir le menu



Sélectionner le sous-menu et confirmer



Confirmer l'effacement ou annuler l'opération

Effacer tous les numéros d'appel



Ouvrir la liste d'appels



Ouvrir le menu



Sélectionner le sous-menu et confirmer



Confirmer l'effacement ou annuler l'opération

Téléphoner

8 Téléphoner

Prendre un appel



Prendre l'appel

Terminer la communication



Terminer la communication

Appeler



Composer le numéro d'appel (max. 24 chiffres)



En cas de saisie erronée, effacer le dernier chiffre

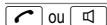

Composer le numéro d'appel



Vous pouvez aussi appuyer d'abord sur la touche , vous obtenez ainsi la tonalité. Les chiffres saisis de votre numéro d'appel seront immédiatement composés. Une correction individuelle des chiffres du numéro n'est pas possible quand la communication est établie de cette manière.

Touche de répétition automatique des derniers numéros

Votre téléphone enregistre les 10 derniers numéros composés dans une liste de répétition automatique des derniers numéros.



Ouvrir la liste de répétition automatique des derniers numéros et sélectionner l'enregistrement



Établir la communication

Le traitement de numéros d'appel placés dans une liste de répétition automatique des derniers numéros est identique à celui des numéros de la liste d'appels  chapitre 7.

Rappeler des numéros d'appel entrés

Votre téléphone enregistre 20 numéros d'appel dans une liste d'appels.



Ouvrir la liste d'appel et sélectionner l'enregistrement



Établir la communication

Composer des numéros d'appel à partir du répertoire

Vous devez avoir enregistré des numéros d'appel dans le répertoire.  chapitre 6



Ouvrir le menu principal



Ouvrir le répertoire



Sélectionner l'enregistrement, établir la communication

Téléphoner

Sélection directe

Vous devez avoir enregistré des numéros d'appel comme numéros de sélection directe ➤ chapitre 5.

3 sec. **M1** ou **M2** Procéder à la sélection directe

Téléphoner en interne¹

Téléphoner en interne

Vous devez avoir déclaré deux ou plusieurs combinés (CB1, CB2, ...) sur votre base afin de pouvoir téléphoner gratuitement en interne.

CB1 : 3 sec. **INT** Introduire la communication interne

Par ex. **2^{ABC}** Composer le numéro interne du combiné désiré

CB2 :  Prendre une communication interne sur un autre combiné

CB1 / CB2 :  Terminer une communication interne

Transférer des communications externes en interne

CB1 : 3 sec. **INT** Pendant la communication externe

Par ex. **2^{ABC}** Composer un numéro d'appel interne

CB2 :  Prendre une communication interne sur un autre combiné

CB1 :  Transférer une communication



Si le combiné appelé ne répond pas, la communication externe retourne au combiné appelant au bout de 30 sec.

Mener des conférences téléphoniques

Une communication externe peut être transformée en conférence téléphonique avec un autre correspondant interne.

CB1 : 3 sec. **INT** Pendant la communication externe

Par ex. **2^{ABC}** Composer un numéro d'appel interne

CB2 :  Prendre une communication interne sur un autre combiné

CB1 : 3 sec. **INT** Démarrer la conférence

CB1 / CB2 :  Terminer la conférence

¹ Téléphoner en interne n'est possible qu'avec au moins deux combinés ➤ "Contrôler le contenu de l'emballage" à la page 39.

Téléphoner

Réglage du volume sonore de la sonnerie de la base

Veillez effectuer le réglage suivant sur la base.



BASE RINGER IS 0, 1, 2, 3, 4, 5



Modifier le réglage

Régler le volume sonore de l'écouteur

Vous pouvez régler le volume sonore sur 5 sensibilités pendant une communication.



Sélectionner le volume sonore désiré

Amplificateur sonore

En plus des 5 sensibilités de volume, vous pouvez sélectionner d'autres amplifications sonores  chapitre 5. Activez l'amplification correspondante pour pouvoir vous en servir.

MODE BOOST	Fonction
OFF	Seul le volume sonore 1-5 est sélectionnable
ON, BAS	Amplification basse sélectionnable en plus
ON, MOYEN	Amplifications basse et moyenne sélectionnables en plus
ON, ÉLEVÉ	Amplifications basse, moyenne et forte sélectionnables en plus
AUTO	En appuyant pendant 2 sec. sur  on sélectionne automatiquement l'amplification la plus forte

Affichage de la durée de la communication

La durée d'une communication est affichée en heures, minutes et secondes.

Mode mains-libres

Utilisez cette fonction pour entendre le correspondant par l'intermédiaire du haut-parleur.



Activer le mode mains-libres



Désactiver le mode mains-libres

Mettre le microphone du combiné sur silencieux

Pendant une communication, vous pouvez activer et désactiver le microphone du combiné.

Élargissement du système téléphonique

3 sec. 

Désactiver le microphone (le mettre sur silencieux)

3 sec. 

Activer le microphone

Verrouillage du clavier

Le verrouillage du clavier doit empêcher que des fonctions soient déclenchées par inadvertance.

3 sec. 

Activer le verrouillage du clavier





Lorsque le verrouillage du clavier est activé, vous pouvez comme d'habitude réceptionner des appels entrants.

3 sec. 



Désactiver le verrouillage du clavier

Chercher le combiné (Paging)

Si vous avez égaré votre combiné, vous pouvez le retrouver facilement grâce à un son de recherche.

Sur la base , 

Démarrer le son de recherche

 ou 

Terminer le son de recherche

9 Élargissement du système téléphonique

Le mode standard international normé **GAP**¹ règle la compatibilité entre les combinés et les bases de fabricants différents. Il est ainsi possible d'intégrer ensemble des appareils SWITEL et des appareils d'autres fabricants dans un système téléphonique. Il est toutefois possible que certaines fonctions ne soient pas disponibles.

Plusieurs combinés



Vous pouvez déclarer 5 combinés sur votre base.

Déclaration de combinés

Avant de déclarer un combiné, vous devez mettre la base en mode de déclaration.

15 sec. 

Démarrer le mode de déclaration

Déclarez maintenant le combiné  chapitre 5. Pour la déclaration, utilisez le code PIN actuellement paramétré  chapitre 5.

Après la déclaration, un numéro d'appel interne est attribué au combiné. Ce numéro interne s'affiche à l'écran.



Pour déclarer des combinés d'autres fabricants, veuillez lire leur mode d'emploi.

¹ **GAP**: **Generic Access Profile** = Standard pour l'action conjointe de combinés et de bases de fabricants différents.

Fonctions particulières

Annulation de combinés



Vous ne pouvez annuler un combiné d'une base que par un autre combiné déclaré sur cette base.

Les combinés s'annulent via le menu. Vous trouverez la position dans le menu au chapitre 5.

Plusieurs bases

Vous pouvez élargir la portée de votre combiné si vous le déclarez sur plusieurs bases. Il peut être déclaré simultanément sur 4 bases différentes. Chaque base a besoin d'une prise téléphonique individuelle. Ces raccordements peuvent porter le même numéro d'appel ou bien des numéros différents.



Les communications en cours ne peuvent pas être transférées d'une base à l'autre.

10 Fonctions particulières

Système de numérotation

Vous pouvez utiliser votre téléphone tant avec les centrales téléphoniques analogiques (numérotation par impulsions) qu'avec les nouvelles centrales téléphoniques numériques (numérotation par tonalité). Le système de numérotation est programmé via le menu. Vous trouvez la position dans le menu au chapitre 5.

11 Installations PABX / Services confort

Touche R sur des installations PABX

Si votre téléphone est raccordé à une installation PABX, vous pouvez, via la **touche R**, tirer profit de certaines fonctions comme par ex. le transfert d'appels et le rappel automatique. Veuillez lire dans le mode d'emploi de votre installation PABX quel temps de flash vous devez paramétrer pour l'utilisation de ces fonctions. Le revendeur, chez lequel vous avez acheté l'installation, vous dira si votre téléphone fonctionne impeccablement sur votre installation PABX. Le temps de flash se paramètre via le menu. Vous trouverez la position dans le menu au chapitre 5.

Pause de numérotation

Dans le cas d'installations PABX, il est nécessaire de composer auparavant un code réseau pour obtenir la tonalité. Sur quelques installations PABX plus anciennes, vous devez attendre quelques instants avant de pouvoir entendre la tonalité. Pour ces installations PABX, une pause de numérotation peut être insérée après le code réseau afin de pouvoir continuer à numéroté directement sans attendre la tonalité. Vous insérez la pause de numérotation en appuyant sur la touche **P** et en la maintenant 3 sec. appuyée.

Après le code réseau, le numéro est composé au bout d'un temps déterminé.



La pause peut également être enregistrée lors de la saisie de numéros d'appel dans le répertoire.

Touche R et services confort

Votre téléphone supporte des services confort de votre opérateur tels que le va-et-vient, la signalisation d'appel en instance et la conférence. Vous pouvez les utiliser via la **touche R**. Demandez à votre opérateur quel temps de flash vous devez paramétrer pour utiliser ces services conforTs. Contactez votre opérateur pour déconnecter ces services. Le temps de flash se paramètre via le menu. Vous trouverez la position dans le menu au chapitre 5.

Affichage du numéro d'appel (CLIP¹)



L'affichage du numéro d'appel est un service confort de votre opérateur. Veuillez lui demander de plus amples informations.

Si cette fonction est disponible sur votre ligne téléphonique, le numéro d'appel du correspondant vous sera affiché dès que le téléphone sonnera. Si votre correspondant a bloqué la transmission de son numéro, un message correspondant sera affiché. Le numéro d'appel ne peut pas être affiché et ainsi ne peut pas non plus être sauvegardé dans la liste d'appels.

Répondeur dans le réseau téléphonique

Le répondeur dans le réseau téléphonique est un service confort offert par de nombreux opérateurs. Si votre opérateur met à votre disposition un répondeur dans le réseau téléphonique, vous serez informé par une icône de l'arrivée de nouveaux messages (**VMWI**²). Vous ne pouvez disposer de cette fonction que si votre opérateur offre ce service. Veuillez lui demander de plus amples informations.

Vous pouvez désactiver l'affichage de l'icône des nouveaux messages. Voir chapitre 5, MSG VOC OFF?.

12 Répondeur

Manipulations sur la base



Votre répondeur dispose d'un guide parlé de l'utilisateur. Tenez compte de ces instructions et indications.

Réglage de la langue

La réponse vocale du répondeur est en anglais.

¹ **CLIP**: Calling Line Identification Presentation = Affichage du numéro d'appel d'un correspondant.

² **VMWI** : Visual Message Waiting Indication = Affichage optique de nouveaux messages.

Répondeur

Activer / Désactiver le répondeur



ANSWER ON / ANSWER OFF



Modifier le réglage

Durée d'enregistrement maximale

La durée d'enregistrement maximale est de 19 minutes. Si la capacité de la mémoire est saturée et ne permet plus de recevoir de nouveaux messages, plus aucun appel ne sera enregistré. Si la mémoire est pleine, un "F" s'affiche à l'écran.

Régler le volume sonore

Vous pouvez régler le volume sonore sur 8 sensibilités.



Régler le volume sonore (u l-uβ)

Report de la prise d'appel

Vous pouvez sélectionner de 3 à 6 sonneries d'appel. Par ailleurs, vous avez la possibilité d'utiliser la consultation préalable à distance gratuite (TIME SAVER). Celle-ci vous permet de constater sans redevance si de nouveaux messages se trouvent sur votre répondeur.

- Si vous avez de nouveaux messages, votre appel sera pris au plus tard après la 3ème sonnerie.
- Si vous n'en avez pas, votre appel ne sera pris qu'après la 5ème sonnerie. Raccrochez avant la 5ème sonnerie. Vous ne paierez pas ainsi de redevances.

Autres informations relatives à la consultation à distance page 62

Régler le report



RING DELAY IS SET TO 3/4/5/6/TIME SAVER



Modifier le réglage

Intercepter un appel

Si le répondeur a déjà répondu à un appel, vous pouvez intercepter celui-ci. L'enregistrement du message est, dans ce cas, interrompu.



Intercepter un appel

Modes de réponse

Votre répondeur met à votre disposition deux modes de réponse. Vous pouvez laisser un message après le texte de réponse ANNOUNCE ONLY IS OFF. Dans le cas du texte de réponse ANNOUNCE ONLY IS ON, il s'agit d'une simple annonce après laquelle vous ne pouvez pas laisser de message.

Sélectionner le mode de réponse



ANNOUNCE ONLY IS OFF /
ANNOUNCE ONLY IS ON



Modifier le réglage

Régler l'annonce

Votre répondeur met à votre disposition un texte d'annonce réglé au préalable. Vous pouvez remplacer le texte d'annonce par vos propres textes. Si la mémoire du répondeur est pleine, c'est le texte d'annonce ANNOUNCE ONLY IS ON qui sera automatiquement reproduit.

Les réglages suivants vous permettent de modifier le texte d'annonce des modes de réponse.

Écouter des annonces



ANNOUNCEMENT IS...

Enregistrer des annonces



ANNOUNCEMENT IS...



Commencer l'enregistrement

Enregistrez maintenant le texte désiré en parlant clairement et distinctement dans le microphone.

Terminer l'enregistrement

Quand vous avez terminé, l'annonce est reproduite à voix haute.

Activer à nouveau le texte d'annonce standard



ANNOUNCEMENT IS...



Restaurer le texte d'annonce standard

Alarme en cas de messages enregistrés

Si un nouveau message ou un mémo a été enregistré, un signal sonore se fait entendre toutes les 10 secondes.



MESSAGE ALERT IS OFF / MESSAGE
ALERT IS ON



Modifier le réglage

Écouter / Effacer les messages enregistrés





Écouter les messages

Les messages enregistrés sont reproduits dans l'ordre dans lequel ils sont entrés. Les nouveaux messages sont reproduits en premier. Le jour de la semaine et l'heure sont toujours indiqués avant la reproduction de chaque message.





Écouter les messages

Répondeur

	Arrêter l'écoute
	Faire répéter le message
2x 	Message précédent
	Message suivant

Effacer un message





	Écouter le message à effacer
	Effacer pendant la reproduction



Les messages effacés ne peuvent pas être restaurés !

Enregistrer un mémo

Un mémo est une information qui peut être écoutée comme un message entré.

 ,  / 	MESSAGE RECORDING
	Enregistrer un mémo

Enregistrez maintenant le texte désiré en parlant clairement et distinctement dans le microphone.

	Terminer l'enregistrement
---	---------------------------





Consultation à distance

Vous pouvez appeler votre répondeur pour écouter des messages et vous servir d'autres fonctions. À condition que votre téléphone soit équipé de la fonctionnalité de numérotation par tonalité.



Code PIN pour la consultation à distance

Le code PIN est réglé à l'usine sur "1234". Il est recommandé de modifier ce code.

Modifier le code PIN

 ,  / 	REMOTE ACCES CODE IS 1234
	Introduire la modification

Sélectionner le chiffre de la première position.

 / 	Sélectionner le chiffre
	Confirmer

Procédez de même pour régler le chiffre de la deuxième, troisième et quatrième position.

Démarrer la consultation à distance



Composer le numéro d'appel personnel



Saisir le code PIN pendant l'annonce

Répondeur

Vous avez maintenant la possibilité d'opérer d'autres fonctions ☞ Tableau de fonctions des touches de la consultation à distance.

Activer la consultation à distance du répondeur



Composer le numéro d'appel personnel



Si vous avez oublié de brancher votre répondeur, votre appel ne sera réceptionné qu'au bout de 17 sonneries.



Saisir le code PIN pendant l'annonce

4

Activer le répondeur

Vous avez maintenant la possibilité de vous servir d'autres fonctions.

Fonctions des touches de la consultation à distance



La consultation à distance est automatiquement interrompue si vous n'effectuez pas de saisie dans les 10 secondes.

Le tableau suivant vous donne une vue d'ensemble des fonctions de chaque touche.

Touche	Fonctions
1	Faire répéter le message en cours
2x 1	Écouter le message précédent
2	Commencer / Arrêter la reproduction du message
3	Écouter le message suivant
4	Activer/ Désactiver le répondeur
7	Écouter le menu Aide
0	Supprimer le message pendant la reproduction
#	Terminer la consultation à distance

Écran du répondeur

L'écran du répondeur indique l'état de l'appareil.

--	Répondeur désactivé
00-XX	Constant : répondeur activé, nombre de messages enregistrés Clignotant : nouveaux messages
⋮	S'affiche lorsqu'un message / une annonce est enregistré(e)

En cas de problèmes

-F

Mémoire pleine

rR

Consultation à distance

13 En cas de problèmes

Hotline de service

Si vous avez des problèmes avec votre téléphone, contrôlez d'abord les indications suivantes. S'il s'agit de problèmes techniques, vous pouvez vous adresser à notre hotline de service en Suisse au numéro de tel. 0900 00 1675 (frais Swisscom à la date d'impression de ce manuel : CHF 2.60/min). En cas de droits de garantie, veuillez vous adresser à votre revendeur. La durée de la garantie est de 2 ans.

Questions et réponses

Questions	Réponses
Pas de communication téléphonique possible	<ul style="list-style-type: none">- Le téléphone n'est pas raccordé correctement ou est en dérangement. N'utilisez que le câble de raccordement téléphonique fourni avec l'appareil.- Testez avec un autre téléphone si votre raccordement téléphonique fonctionne.- Le bloc secteur n'est pas branché ou il y a une panne totale de courant.- Les piles rechargeables sont vides ou défectueuses.- Vous vous êtes trop éloigné de la base.- Programmation erronée du système de numérotation ☞ page 49.
Pas de connexion possible avec la base	<ul style="list-style-type: none">- Contrôlez que vous vous êtes déclaré sur la base avec le code PIN correct ☞ page 49.
La liaison est hâchée, s'interrompt	<ul style="list-style-type: none">- Vous vous êtes trop éloigné de la base.- Mauvais lieu d'installation de la base.
Le système ne réagit plus	<ul style="list-style-type: none">- Remettez toutes les fonctions en configuration usine ☞ page 48/49.- Retirez le bloc secteur de la prise de courant pendant un court instant.

Caractéristiques techniques

Les piles rechargeables se vident très rapidement	<ul style="list-style-type: none">- Les piles rechargeables sont vides ou défectueuses.- Placez le combiné correctement sur la base. Nettoyez les surfaces de contact du combiné et de la base avec un chiffon doux et sec .- Posez le combiné sur la base et laissez-le pendant 16 heures .
L'affichage du numéro d'appel (CLIP) ne fonctionne pas	<ul style="list-style-type: none">- L'affichage du numéro d'appel est un service confort de votre opérateur. Veuillez lui demander de plus amples informations.- Le correspondant a bloqué la transmission de son numéro d'appel.
Le répondeur n'enregistre pas de messages/mémos	<ul style="list-style-type: none">- Contrôlez si la mémoire du répondeur est pleine. Effacez le cas échéant des messages se trouvant dans la mémoire ☞ Page 62.
Vous ne pouvez pas consulter à distance	<ul style="list-style-type: none">- Contrôlez si vous utilisez le code de sécurité correct pour la consultation à distance ☞ Page 62.- Le téléphone que vous utilisez pour la consultation à distance doit être réglé sur la numérotation par tonalité.

14 Caractéristiques techniques

Caractéristiques techniques

Caractéristique	Valeur
Standard	DECT¹-GAP²
Alimentation en courant (base)	Entrée : 220/230 V, 50 Hz Sortie : 7.5 V, 320 mA
Alimentation en courant (chargeur)	Entrée : 220/230 V, 50 Hz Sortie : 6 V, 150 mA

¹ **DECT**: Digital Enhanced Cordless Telecommunication = Standard pour les téléphones sans fil.

² **GAP**: Generic Access Profile = Standard pour l'action conjointe de combinés et de bases de fabricants différents.

Caractéristiques techniques

Portée	À l'extérieur : env. 300 m À l'intérieur : env. 50 m
Autonomie en veille	Jusqu'à 100 h
Durée max. de communication	Jusqu'à 10 h
Piles rechargeables	2 x AAA NiMH 1.2 V
Système de numérotation	Numérotation par tonalité Numérotation par impulsions
Température ambiante autorisée	10°C à 30°C
Humidité atmosphérique relative autorisée	20% à 75%
Fonction de flash	100 ms, 300 ms, 600 ms

Réglages usine

Combiné

Les paramétrages en usine sont rétablis via le menu. La page 48 vous donnera la position dans le menu.

LANGUE = ALLEMAND	RÉPERTOIRE = vide
JRNAL APPELS = vide	RECOMPOSER = vide
M1, M2 = vide	ALARMES 1/2 = OFF
MÉLODIE EXTERNE = 1	MÉLODIE INTERNE = 2
VOLUME SONNERIE = 3	AUTO TALK = ON
MODE BOOST = AUTO	
RÉGLER RÉTROÉCL. = 10 sec.	

Base

Les paramétrages en usine sont rétablis via le menu. La page 49 vous donnera la position dans le menu.

MÉLODIE BASE = 2	VOLUME SONNERIE = 1
MODE NUM = TONALITÉ	PIN = 0000

Remarques d'entretien / Garantie

Déclaration de conformité

Cet appareil répond aux exigences des directives de l'union européenne (UE) : 1999/5/CE Directive sur les installations de radio et de télécommunication et la reconnaissance réciproque de leur conformité. La conformité à la directive ci-dessus est confirmée sur l'appareil par le symbole CE.



Pour obtenir la déclaration de conformité intégrale, veuillez vous servir du téléchargement gratuit de notre site Internet www.switel.com.

15 Remarques d'entretien / Garantie

Remarques d'entretien

- Nettoyez les surfaces du boîtier avec un chiffon doux et non pelucheux.
- N'utilisez pas de produits d'entretien ou de solvants.

Garantie

Les appareils SWITEL sont fabriqués et contrôlés selon les procédés les plus modernes. Des matériaux sélectionnés et des technologies de pointe ont pour effet un fonctionnement irréprochable et une longue durée de vie. La garantie ne rentre pas en jeu si l'exploitant du réseau téléphonique ou une installation PABX éventuellement intercalée est responsable du dysfonctionnement de l'appareil. La garantie ne s'applique pas aux piles, piles rechargeables ou packs de piles rechargeables utilisés dans les produits. La durée de la garantie est de 24 mois à partir de la date d'achat.

Pendant la période de garantie, tous les défauts dus à des vices de matériel ou de fabrication seront éliminés gratuitement. Le droit à la garantie expire en cas d'intervention de l'acheteur ou de tiers. Les dommages provenant d'un maniement ou d'une manipulation incorrects, d'une usure naturelle, d'une mauvaise mise en place ou d'une mauvaise conservation, d'un raccordement ou d'une installation incorrects ainsi que d'un cas de force majeure ou autres influences extérieures sont exclus de la garantie. En cas de réclamations, nous nous réservons le droit de réparer, de remplacer les pièces défectueuses ou d'échanger l'appareil. Les composants remplacés ou les appareils échangés deviennent notre propriété. Les demandes de dommages et intérêts sont exclues tant qu'elles ne reposent pas sur l'intention ou une négligence grossière du fabricant.

Si votre appareil devait malgré tout présenter une défectuosité pendant la période de garantie, veuillez vous adresser, muni de la quittance d'achat, exclusivement au magasin où vous avez acheté votre appareil SWITEL. Vous ne pouvez faire valoir vos droits à la garantie selon ces dispositions qu'auprès de votre revendeur exclusivement. Deux ans après l'achat et la remise de nos produits, il n'est plus possible de faire valoir les droits à la garantie.

Index

16 Index

A

Activer, 60
Activer la consultation à distance, 63
Affichage des numéros d'appel, 52
Affichage du numéro d'appel, 59
Alarme, 47, 61
Amplificateur sonore, 56
Annonce, 61
Annonces, 61
Annulation, 58
Annuler, 49
Appeler, 54

B

Base, 40, 58

C

Caractéristiques techniques, 65
Chargeur, 40
Chercher, 57
CLIP, 59
Code PIN, 62
Combiné, 57
Communications internes, 55
Composer des numéros, 54
Conférences téléphoniques, 55
Consignes de sécurité, 38
Consultation à distance, 62
Contenu de l'emballage, 39
Créer, 45, 50

D

Date, 41
Déclaration, 57
Déclaration de conformité, 67
Déclarer, 49
Désactiver, 60
Durée d'enregistrement maximale, 60
Durée de la communication, 56

E

Économiseur de taxes, 60
Écouter, 61
Écran, 44, 63
Effacer, 51, 53, 61
Effacer des messages, 62
Élargissement, 57
Éléments de manipulation, 42
Emploi, 43
Enregistrement, 61
Enregistrements dans le répertoire, 50
Enregistrements du répertoire, 45
Enregistrer, 50
Enregistrer un mémo, 62

F

Fonctions, 58
Fonctions des touches, 63

G

Garantie, 67

H

Heure, 41
Hotline de service, 64

I

Icônes, 44
Icônes à l'écran, 44
Installations PABX, 58
Interception d'appel, 60

L

Langue, 59
Langue de l'écran, 41
Liste d'appels, 46, 52

M

Manipulations sur la base, 59
Mélodie de la sonnerie d'appel, 47, 49
Menu principal, 46
Messages, 52, 61
Messages à l'écran, 52
Mettre en place les piles rechargeables, 41
Mise du micro sur silencieux, 56
Mise en service, 39
Mise sur silencieux, 56
Mode ÉCO, 42
Mode mains-libres, 56
Mode veille, 45
Modifier, 51
Modifier le code PIN, 62

N

Niveau de chargement des piles, 41
Notations, 43
Numérotation par impulsions, 49, 58
Numérotation par tonalité, 49, 58

P

Paging, 57
Pause de numérotation, 58
Prise d'appel, 41, 54
Problèmes, 64

Q

Questions et réponses, 64

R

Raccord du casque, 43
Raccrocher, 54
Rappel, 54
Recharger, 41
Réduction du rayonnement, 42
Réglages usine, 48, 49, 66
Régler l'annonce, 61
Remarques d'entretien, 67
Répertoire, 46, 50, 54
Répétition automatique des derniers numéros, 47
Répondeur, 59
Répondeur dans le réseau téléphonique, 59
Report, 60

Index

S

- Saisie de nom, 50
- Saisie de texte, 50
- Sauvegarder, 45, 53
- Sélection directe, 52, 55
- Sélectionner le mode de réponse, 60, 61
- Services confort, 58
- Structure du menu, 46
- Suppression d'erreurs, 64
- Système de numérotation, 49, 58

T

- Téléphoner, 54
- Terminer la communication, 54
- Touche de répétition automatique
des derniers numéros, 54
- Touche R, 58, 59
- Transfert, 55
- Transfert de communication, 55

V

- Verrouillage du clavier, 57
- VMWI, 59
- Volume sonore, 60
- Volume sonore de l'écouteur, 56
- Volume sonore de la sonnerie, 56

Contenuto

1	Indicazioni di sicurezza	72
2	Mettere in funzione il telefono	73
3	Elementi di comando	76
4	Informazioni introduttive	77
5	Struttura dei menu	79
6	Rubrica telefonica	84
7	Elenco chiamate	86
8	Compiere telefonate	88
9	Ampliamento del sistema telefonico	91
10	Funzioni speciali	92
11	Impianti telefonici interni / Servizi addizionali	92
12	Segreteria telefonica	94
13	In presenza di problemi	98
14	Specifiche tecniche	100
15	Consigli per la cura / Garanzia	102
16	Indice alfabetico	103

Indicazioni di sicurezza

1 Indicazioni di sicurezza

Leggere attentamente le presenti istruzioni per l'uso.

Impiego conforme agli usi previsti

Il presente telefono consente di svolgere telefonate all'interno di una rete telefonica. Qualsiasi altro impiego è considerato come non conforme agli usi previsti. Non sono consentite modifiche o trasformazioni non autorizzate. Non aprire per nessuna ragione l'apparecchio autonomamente, né compiere riparazioni di propria iniziativa.

Luogo di installazione

Evitare un'esposizione a fumo, polvere, vibrazioni, sostanze chimiche, umidità, calore e raggi solari diretti.

Non utilizzare l'unità portatile in aree esposte al rischio di deflagrazione.

Alimentatore di rete



Attenzione: Utilizzare solo l'alimentatore a spina fornito in dotazione visto che altri alimentatori di rete potrebbero addirittura danneggiare il telefono. Non ostacolare il libero accesso all'alimentatore a spina con mobili o altri oggetti simili.

Accumulatori ricaricabili



Attenzione: Non gettare gli accumulatori ricaricabili nel fuoco. Utilizzare solo accumulatori dello stesso tipo. Osservare la corretta polarità! Pericolo di esplosione durante il caricamento degli accumulatori in caso di errata polarità.

Caduta di tensione

In caso di caduta di tensione non è possibile compiere chiamate con questo telefono. Si consiglia di ricorrere in caso di emergenza ad un telefono con filo in grado di funzionare anche senza alimentazione elettrica esterna.

Apparecchiature mediche



Attenzione: Non utilizzare il telefono in prossimità di apparecchiature mediche. Non è infatti possibile escludere il rischio di possibili interferenze.

Compatibilità con apparecchi acustici

Il telefono è compatibile con il maggior numero di apparecchi acustici presenti sul mercato. Ciò nonostante non è possibile garantire un perfetto funzionamento con qualsiasi tipo di apparecchio acustico.

Telefoni DECT¹ possono causare un fastidioso ronzio in apparecchi acustici.

¹ **DECT:** Digital Enhanced Cordless Telecommunication = Standard per telefoni senza cavo.

Mettere in funzione il telefono

Smaltimento

Procedere allo smaltimento dell'apparecchio esaurito consegnandolo presso uno dei punti di raccolta istituiti dalla propria società di smaltimento rifiuti comunale (ad es. centro di riciclo materiali). Il simbolo riportato qui a lato indica che non è assolutamente consentito smaltire l'apparecchio assieme ai normali rifiuti domestici! Secondo quanto previsto dalla legge sugli apparecchi elettrici ed elettronici, i proprietari di apparecchi esauriti sono per legge tenuti alla consegna di tutti gli **apparecchi elettrici ed elettronici** presso un centro di rilievo rifiuti in raccolta differenziata.



Consegnare gli accumulatori per lo smaltimento presso rivenditori al dettaglio di batterie o centri di raccolta che mettono a disposizione appositi contenitori.



Smaltire **confezioni ed imballaggi** in base a quanto indicato dalle norme in vigore a livello locale.

2 Mettere in funzione il telefono

Indicazioni di sicurezza



Attenzione: Prima della messa in funzione, leggere attentamente le indicazioni di sicurezza riportate al capitolo 1.

Verificare il contenuto della confezione

La confezione contiene:

Contenuto	Modello DCT627x ¹			
	6271	6272	6273	6274
Stazione base con alimentatore di rete	1	1	1	1
Stazione di carica con alimentatore di rete	-	1	2	3
Unità portatile	1	2	3	4
Cavo di collegamento telefonico	1	1	1	1
Accumulatori	2	4	6	8
Istruzioni per l'uso	1	1	1	1

¹ Per ulteriori informazioni riguardo la disponibilità di questo telefono/set telefonico si prega di visitare il sito www.switel.com.

Mettere in funzione il telefono

Collegare la stazione base



Attenzione: Montare la stazione base con una distanza minima di 1 m da altri apparecchi elettronici in modo da evitare interferenze reciproche.

Procedere al collegamento della stazione base seguendo quanto raffigurato nella figura. Utilizzare per motivi di sicurezza solo l'alimentatore di rete oltre al cavo di collegamento telefonico fornito in dotazione.

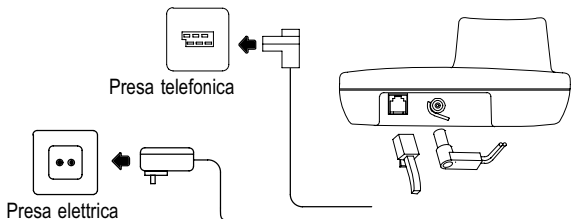

Utilizzare per la stazione base l'alimentatore di rete con il codice KG2B-075-0320D e i dati di output 7.5 V, 320 mA.

Collegare la stazione di carica¹

Procedere al collegamento della stazione di carica seguendo la figura. Per motivi di sicurezza si prega di utilizzare soltanto l'alimentatore di rete fornito in dotazione.

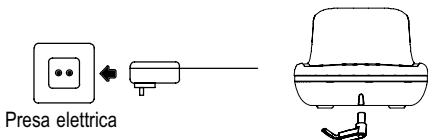

Utilizzare per la stazione di carica l'alimentatore di rete con i dati di output 6 V, 150 mA.

¹ Vale solo per set telefonici con minimo due unità portatili ➤ "Verificare il contenuto della confezione" a pagina 73.

Mettere in funzione il telefono

Inserire gli accumulatori

Inserire le batterie ricaricabili nel vano accumulatori precedentemente aperto. Utilizzare esclusivamente batterie ricaricabili di tipo AAA NiMH 1,2 V. Osservare la corretta polarità! Chiudere infine il vano accumulatori.

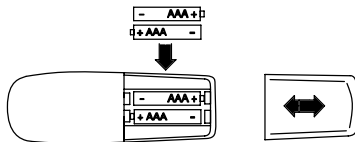

Caricare gli accumulatori



Riporre l'unità portatile in sede di prima messa in funzione per **minimo** 16 ore nella stazione base / stazione di carica.

[Non appena il portatile è posizionato correttamente nella stazione base/stazione di carica, si avverte un segnale di avviso.] [Avendo posizionato l'unità portatile nella stazione base/stazione di carica in maniera corretta, la spia di controllo dello stato di carica è accesa.] L'unità portatile si surriscalda durante il processo di carica. Questo è un fenomeno normale e non pericoloso. Evitare di caricare l'unità portatile con dispositivi di carica differenti o estranei. Lo **stato di carica** attuale è visualizzato sul display:



Carico



Metà carico



Debole



Scarico

Impostare la lingua di display

Selezionare la lingua che interessa (vedi anche "Struttura di menu"):

[] > MOBILTEIL > SPRACHE >...

[] > PORTATILE > LINGUA >...

È possibile scegliere tra le lingue tedesco, francese, italiano e inglese.

Impostare data e ora dell'unità portatile

Una voce di menu consente di impostare data e ora. A pagina 81 è indicata la posizione da scorrere nel menu.

Accettazione di chiamata automatica

L'attivazione di questa funzione consente di ricevere automaticamente una chiamata estraendo semplicemente l'unità portatile dalla stazione base. L'accettazione di chiamata automatica è attivata o disattivata nel menu. A pagina 82 è indicata la posizione da scorrere nel menu.

Elementi di comando

Impianti telefonici interni

A pagina 92 sono riportate ulteriori informazioni nel caso in cui si volesse collegare il telefono ad un impianto telefonico interno.

Riduzione delle radiazioni (modalità ECO)

La radiazione in modalità di stand-by è stata considerevolmente ridotta se paragonata a quella emessa da telefoni cordless a standard DECT, con unità portatili nella base.



In modalità di conversazione le radiazioni sono ridotte in base alla distanza dell'unità portatile rispetto alla base.

3 Elementi di comando

I tasti del telefono riportati nel presente manuale d'istruzioni per l'uso sono raffigurati sotto forma di simboli uniformi all'interno di un riquadro. Sono possibili lievi scostamenti dei simboli dei tasti sul telefono rispetto ai simboli qui raffigurati.

Unità portatile

- 1 Altoparlante
- 2 Display LCD
- 3 Tasto menu/Tasto OK
- 4 Tasto di selezione rapida M2
- 5 Collegamento per auricolare
- 6 Tasto cancella/Tasto R
- 7 Tasto di vivavoce
- 8 Tasti numerici
- 9 Tasto #/
Blocco tastiera
- 10 Microfono
- 11 Tasto pausa
- 12 Tasto */
Chiamate interne
- 13 Tasto conversazione/
Tasto di riaggancio
- 14 Tasto freccia in basso/
Elenco chiamate
- 15 Tasto di selezione rapida M1
- 16 Tasto freccia in alto/
Ripetizione di chiamata
- 17 LED

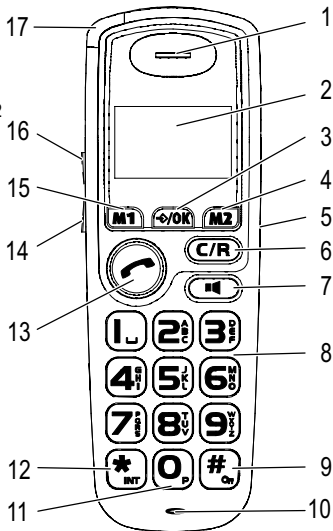

Informazioni introduttive

Presenza di collegamento per auricolare

Sul lato destro dell'unità portatile si trova una presa per l'allacciamento di una cuffia auricolare. Si consiglia di utilizzare un auricolare con una presa jack stereo da 2,5 mm. Non si assume alcuna garanzia riguardo al rispettivo funzionamento.

Stazione base

- 1 Contatti di carica
- 2 Altoparlante
- 3 Display LC
- 4 Volume +
- 5 Volume -
- 6 Navigare in avanti /
Messaggio successivo
- 7 Riproduzione / Stop /
Confermare/Concludi
impostazione
- 8 Navigare indietro /
Messaggio precedente
- 9 Cancella messaggio/annuncio
- 10 Modifica menu/impostazione
- 11 Tasto di paging

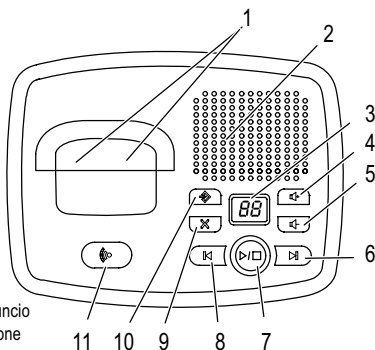

4 Informazioni introduttive

In questo capitolo sono riportate le principali informazioni riguardo l'uso delle presenti istruzioni e del telefono.

Modi di rappresentazione nelle istruzioni per l'uso

Rappresentazione	Descrizione
	Rappresentazione dei tasti
	Premere brevemente il tasto raffigurato
2 sec.	Premere il tasto raffigurato per 2 secondi
	Inserire numeri o lettere
	Unità portatile squilla
	Estrarre l'unità portatile dalla stazione base
	Riporre l'unità portatile nella stazione base

Informazioni introduttive



Rappresentazione di testi sul display



Rappresentazione di simboli sul display

Simboli e testi sul display dell'unità portatile

Simbolo	Descrizione
	Costante: Indicazione dello stato di carica delle batterie. Lampeggiante: Caricare gli accumulatori. Segmenti che scorrono: Gli accumulatori sono in fase di ricarica ☞ pagina 75.
1	Numero di chiamata interno dell'unità portatile ☞ pagina 91.
12--59	Visualizzazione dell'ora ☞ pagina 81.
	Condurre una chiamata ☞ pagina 88.
	Ci si trova nell'elenco chiamate. Presenza di nuove chiamate nell'elenco chiamate ☞ pagina 86.
	La segnalazione acustica di chiamata è disinserita ☞ pagina 81.
	La funzione vivavoce è attivata ☞ pagina 90.
	Il blocco tastiera è attivato ☞ pagina 91.
	La funzione di allarme è attivata.
ATTENDERE	Segreteria telefonica integrata nella rete telefonica. VMWI ¹ - Servizio aggiuntivo del proprio gestore di rete telefonica ☞ pagina 93.
	Collegamento con la stazione base è buono.

Modalità di stand-by

In tutte le descrizioni del presente manuale di istruzioni si considera l'unità portatile in modalità di stand-by. L'unità portatile passa alla modalità di stand-by nel momento in cui non si svolge alcuna chiamata e con menu chiusi. Premere se occorre ripetutamente il tasto per passare alla modalità di stand-by.

Navigazione nel menu

I differenti menu consentono di raggiungere tutte le funzioni del telefono. Il percorso da

Struttura dei menu

seguire per giungere alla funzione desiderata è indicata dalla struttura di menu
☞ pagina 79.

	Aprire il menu principale
o	Selezionare il sottomenu desiderato
	Aprire il sottomenu
o	Selezionare la funzione desiderata
	Aprire la funzione
o	Selezionare l'impostazione desiderata
	La tastiera consente di inserire numeri o lettere
	Confermare le immissioni
C	Tornare indietro di un livello
premere ripetutamente C	Interrompere procedure di programmazione e memorizzazione e ripassare alla modalità di stand-by



Ogni singolo processo si interrompe automaticamente se entro 15 secondi non si procede con una immissione.

Creare voci nella rubrica telefonica - Esempio

La navigazione nei menu e la procedura da seguire per compiere impostazioni è indicata a titolo esemplificativo in **Creare voci nella rubrica telefonica**. Si consiglia di seguire quanto riportato nell'esempio per tutte le impostazioni che si desiderano compiere.





	Aprire il menu principale
RUBRICA	Aprire la rubrica telefonica
	Saltare la selezione di voci
AGGIUNGI	Selezionare un sottomenu e confermare
	Immettere un nome (max. 12 segni) e confermare
	Immettere un numero di chiamata (max. 24 cifre) e confermare



5 Struttura dei menu





Menu principale

Per passare al menu principale, premere il tasto . Selezionare quindi una voce



Struttura dei menu

con i tasti  o  e confermare la scelta con il tasto .
Maggiori informazioni su menu ed esercizio  capitolo 4.

RUBRICA, selezionare /, saltare una voce 

AGGIUNGI	NOME  ¹	NUMERO 
MODIFICA	NOME 	NUMERO 
CANCELLA	CONFERMA?	
CANCELLA TUTTO	CONFERMA?	

CHIAMATE², selezionare /, saltare una voce 

SALVA IN RUBRICA	NOME 	NUMERO 
CANCELLA	CONFERMA?	
CANCELLA TUTTO	CONFERMA?	



¹ I tasti numerici riportano altresì delle lettere. Premendo ripetutamente il relativo tasto si ha modo di selezionare lettere, cifre e caratteri speciali.

² Per visualizzare e memorizzare numeri di chiamata in elenchi chiamate è necessaria la visualizzazione del numero di chiamata (**CLIP**³). La visualizzazione del numero di chiamata è un servizio addizionale offerto dal proprio gestore di rete telefonica. Si consiglia di rivolgersi al proprio gestore di rete telefonica per ricevere ulteriori informazioni a riguardo. Per ulteriori informazioni sulla visualizzazione del numero di chiamata vedi  pagina 86.



³ **CLIP**: Calling Line Identification Presentation = Visualizzazione del numero telefonico del chiamante.

Struttura dei menu











RIPETI, selezionare / , saltare una voce 

SALVA IN RUBRICA	NOME 	NUMERO 
CANCELLA	CONFERMA?	
CANCELLA TUTTO	CONFERMA?	



SVEGLIA

SVEGLIA 1	ANNULLA		
	IMPOSTA	ORA 	CONFERMA?
SVEGLIA 2	ANNULLA		
	IMPOSTA	ORA 	CONFERMA?

PORTATILE

MELODIA	MELODIA EST	MELODIA 1-10
	MELODIA INT	MELODIA 1-10
VOL.SUONERIA	VOLUME 1-5, OFF	
IMPOSTA	DATA/ORA	DATA  
		 CONFERMA?
		ORA  
		 CONFERMA?
	FORMATO	DATA  
		 GG/MM
		 MM/GG



Struttura dei menu

↖		ORA  ↗
		↗ 12 H
		↗ 24 H
AMPLIFICATO	ON	BASSO
		MEDIO
		ALTO
	AUTO	
	OFF	
TONI	ON/OFF	
CONTRASTO	LIVELLO 1-8	
NOME DEL TELEFONO		
ILLUMINAZ.	5-30 SECONDI	
RISPOSTA AUTO	ON/OFF	
LINGUA ¹		
RESET	CONFERMA?	



¹Le lingue disponibili sono riportate nel  capitolo 2.

Struttura dei menu

IMPOSTA BASE, PIN: ¹

MELODIA BASE	MELODIA 1-5	
VOL.SUONERIA	VOLUME 1-5, OFF	
MODIFICA PIN ¹	NUOVO PIN 	CONFERMA PIN 
SELEZIONE	TONI	
	IMPULSI	
FLASH	BREVE	
	MEDIO	
	LUNGO	
VMWI ²	VMWI SPENTO?	
RESET	CONFERMA?	

AFFILIAZIONE

REGISTRA	PIN: 	
SELEZIONA BASE	BASE 1-4	
DEREGISTRA	PIN: 	PORTATILE1-4
DEREGISTRA	BASE 1-4	

¹ Il codice PIN è impostato in fabbrica su "0000".

² **VMWI**: **V**isual **M**essage **W**aiting **I**ndication = Visualizzazione ottica per messaggi nuovi.

Rubrica telefonica





6 Rubrica telefonica

Nella rubrica telefonica è possibile memorizzare 100 numeri di chiamata con rispettivi nomi.

- Assegnare a tutti i numeri di chiamata sempre un prefisso in modo da poter riconoscere anche una chiamata urbana in arrivo ed abbinarla ad una voce presente nella rubrica telefonica.
- Con capacità di memoria esaurita, sul display è visualizzata l'indicazione  dopo aver memorizzato l'ultimo messaggio. Per poter disporre di nuovo spazio memoria, cancellare prima una voce già presente.
- Le voci della rubrica telefonica sono elencate in ordine alfabetico.

Immettere nomi









I tasti numerici riportano altresì delle lettere. Premendo ripetutamente il relativo tasto si ha modo di selezionare lettere, cifre e caratteri speciali.

	Immettere spazi vuoti
	Cancellare
 o 	Muovere il cursore



Per immettere la stessa lettera una seconda volta, premere il rispettivo tasto. Attendere fino a quando il cursore si sia spostato di una posizione. Immettere quindi la lettera una seconda volta.

Creare voci nella rubrica telefonica

	Aprire il menu principale
RUBRICA 	Aprire la rubrica telefonica
	Saltare la selezione di voci
AGGIUNGI 	Selezionare un sottomenu e confermare
 	Immettere un nome (max. 12 segni) e confermare
 	Immettere un numero di chiamata (max. 24 cifre) e confermare

Rubrica telefonica

Modificare voci nella rubrica telefonica

	Aprire il menu principale
RUBRICA	Aprire la rubrica telefonica
o	Selezionare la voce e confermare
o MODIFICA	Selezionare un sottomenu e confermare
	Modificare il nome e confermare
	Modificare il numero di chiamata e confermare

Cancellare voci nella rubrica telefonica

Cancellare una voce

	Aprire il menu principale
RUBRICA	Aprire la rubrica telefonica
	Selezionare la voce e confermare
o CANCELLA	Selezionare un sottomenu e confermare
CONFERMA? o C	Confermare o interrompere la procedura di cancellazione

Cancellare tutte le voci

	Aprire il menu principale
RUBRICA	Aprire la rubrica telefonica
	Saltare la selezione di voci
o CANCELLA TUTTO	Selezionare un sottomenu e confermare
CONFERMA? o C	Confermare o interrompere la procedura di cancellazione

Elenco chiamate

Selezione diretta

È possibile memorizzare 1 numero di chiamata come numero di selezione diretta rispettivamente sui tasti **M1** e **M2**.

Memorizzare numeri di chiamata come numeri di selezione diretta

Immettere un numero o selezionare una voce dalla rubrica telefonica, dall'elenco di ripetizione di chiamata o dall'elenco chiamate.

3 sec. **M1** o **M2**

La selezione è salvata sul rispettivo tasto di selezione diretta



Le voci salvate come tasti di selezione diretta non possono essere cancellati bensì soltanto sovrascritti.

7 Elenco chiamate

All'interno dell'elenco chiamate è possibile memorizzare in tutto 20 numeri telefonici.



La visualizzazione del numero di chiamata (**CLIP**¹) è un servizio aggiuntivo del proprio gestore di rete telefonica. Nel caso in cui il gestore della rete telefonica supporti il servizio, sul display del telefono è visualizzato il numero di chiamata. Per maggiori dettagli a riguardo, rivolgersi al proprio gestore di rete telefonica.

Messaggi sul display:

FUORI AREA	Il numero di chiamata è stato ricevuto solo in parte o non correttamente.
INTERNAZ.	L'informazione relativa al numero di chiamata non è disponibile. Si potrebbe anche trattare di una chiamata internazionale.
RISERVATO	Il chiamante ha disattivato la trasmissione del proprio numero di chiamata.

Visualizzare numeri di chiamata dall'elenco chiamate



Aprire l'elenco chiamate e selezionare una voce











Premere se occorre ripetutamente il tasto ***** per scorrere nel display tra le voci "Nome", "Numero" e "Data/Orario di ricezione".

¹ **CLIP**: Calling Line Identification Presentation = Visualizzazione del numero telefonico del chiamante.

Elenco chiamate

Memorizzare nella rubrica un numero di chiamata dall'elenco chiamate

È possibile memorizzare un numero di chiamata direttamente dall'elenco chiamate nella rubrica telefonica.









 ,  o 	Aprire l'elenco chiamate e selezionare una voce
	Aprire il menu
 o  , SALVA IN RUBRICA , 	Selezionare il sottomenu e confermare
 , 	Immettere un nome (max. 12 segni) e confermare
 , 	Modificare il numero di chiamata e confermare









Non appena al numero di chiamata nella rubrica telefonica è assegnato un nome, nell'elenco chiamate è visualizzato il nome inserito.

Cancellare numeri di chiamata dall'elenco chiamate

Cancellare singoli numeri di chiamata

 ,  o 	Aprire l'elenco chiamate e selezionare una voce
	Aprire il menu
 o  , CANCELLA , 	Selezionare un sottomenu e confermare
CONFERMA? ,  o C	Confermare o interrompere la procedura di cancellazione

Cancellare tutti i numeri di chiamata

	Aprire l'elenco chiamate
	Aprire il menu
 o  , CANCELLA TUTTO , 	Selezionare un sottomenu e confermare
CONFERMA? ,  o C	Confermare o interrompere la procedura di cancellazione

Compiere telefonate

8 Compiere telefonate

Accettare una chiamata

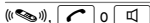

Ricevere una chiamata

Concludere una chiamata



Concludere una chiamata

Compiere telefonate



Immettere un numero di chiamata (max. 24 cifre)



In caso di immissione errata, cancellare l'ultima cifra



Selezionare il numero di chiamata



È altresì possibile premere prima il tasto  e ottenere quindi il segnale di linea libera. Le cifre immesse per la composizione del numero di chiamata desiderato sono immediatamente selezionate. Nel corso di una simile chiamata non è possibile eseguire la correzione di singole cifre che compongono il numero di chiamata.

Ripetizione di chiamata

Il telefono memorizza i 10 ultimi numeri di chiamata selezionati all'interno di un elenco di ripetizione di chiamata.



Aprire l'elenco di ripetizione di chiamata e selezionare una voce



Instaurare un collegamento

La modifica di numeri di chiamata presenti nell'elenco di ripetizione di chiamata è identica alla modifica descritta per i numeri di chiamata nell'elenco chiamate

☞ capitolo 7.

Richiamare una telefonata ricevuta

Il telefono memorizza 20 numeri telefonici in un elenco chiamate.



Aprire l'elenco chiamate e selezionare una voce



Instaurare un collegamento

Selezionare numeri di chiamata dalla rubrica telefonica

I numeri di chiamata devono risultare memorizzati nella rubrica telefonica

☞ capitolo 6.



Aprire il menu principale

Compiere telefonate

RUBRICA		Aprire la rubrica telefonica
o ,		Selezionare una voce, instaurare un collegamento

Selezione diretta

I numeri di chiamata devono risultare memorizzati come numeri di chiamata diretta capitolo 5.

3 sec. M1 o M2	Eseguire la selezione diretta
------------------------------	-------------------------------

Compiere chiamate interne¹

Condurre chiamate interne

Per condurre telefonate interne gratuite bisogna aver registrato due o più unità portatili (UP1, UP2, ...) presso la stazione base.

UP1: 3 sec. INT	Avviare una chiamata interna
ad es. 2^{ABC}	Selezionare il numero di chiamata interno del portatile desiderato
UP2:	Accettare una telefonata interna presso l'altra unità portatile
UP1 / UP2:	Concludere la telefonata interna

Trasferire internamente chiamate esterne

UP1: 3 sec. INT	Con chiamata esterna in corso
ad es. 2^{ABC}	Selezionare un numero di chiamata interno
UP2:	Accettare una telefonata interna presso l'altra unità portatile
UP1:	Trasferire la chiamata



Nel caso in cui il portatile chiamato non dovesse rispondere, trascorsi 30 sec. la telefonata è di nuovo trasferita al portatile chiamante.



Condurre chiamate a conferenza

Questa funzione consente di condurre una conferenza con una chiamata esterna ed un altro interlocutore interno.

UP1: 3 sec. INT	Con chiamata esterna in corso
ad es. 2^{ABC}	Selezionare un numero di chiamata interno





¹ Per compiere telefonate interne sono necessarie minimo due unità portatili "Verificare il contenuto della confezione" a pagina 73.

Compiere telefonate

UP2: 	Accettare una telefonata interna presso l'altra unità portatile
UP1: 3 sec. INT	Avviare la chiamata in conferenza
UP1 / UP2: 	Concludere la chiamata in conferenza

Impostare il volume di squillo base

Le seguenti impostazioni vanno eseguite sulla base.

 ,  / 	BASE RINGER IS 0, 1, 2, 3, 4, 5
	Modificare l'impostazione

Impostare il volume del ricevitore

Il volume è regolabile durante lo svolgimento di una chiamata in 5 livelli.

 o 	Selezionare il volume desiderato
---	----------------------------------

Amplificazione acustica

Oltre ai 5livelli di volume è possibile prevedere un'ulteriore amplificazione acustica del parlato  capitolo 5. Attivare la rispettiva amplificazione per poter usufruire della funzione.

AMPLIFICATO	Funzione
OFF	Possibile selezionare soltanto volume 1-5
ON, BASSO	Possibile selezionare in più un'amplificazione bassa
ON, MEDIO	Possibile selezionare in più un'amplificazione bassa e media
ON, ALTO	Possibile selezionare in più un'amplificazione bassa, media e alta
AUTO	Premendo 2 sec.  l'apparecchio applica automaticamente l'amplificazione più alta.

Visualizzazione della durata di conversazione

Durante lo svolgimento di una chiamata, la durata della conversazione è visualizzata in ore, minuti e secondi sul display.

Funzione vivavoce

Utilizzare questa funzione per ascoltare il partner di chiamata attraverso l'altoparlante.

	Attivare la funzione vivavoce
	Disattivare la funzione vivavoce

Ampliamento del sistema telefonico

Silenziamento del microfono nell'unità portatile

È possibile attivare e disattivare il microfono dell'unità portatile con chiamata telefonica in corso.

3 sec. 

Disattivare il microfono (silenziamento)

3 sec. 

Attivare il microfono

Blocco tastiera

Il blocco tastiera aiuta ad impedire l'attivazione inavvertita di determinate funzioni.

3 sec. 

Attivare il blocco tastiera





L'attivazione del blocco tastiera consente di ricevere telefonate in arrivo come di consueto.

3 sec. 

Disattivare il blocco tastiera

Cercare l'unità portatile (funzione di paging)

Avendo perso d'occhio la propria unità portatile è possibile ritrovarla facilmente grazie all'emissione di un tono di ricerca.

Presso la base , 

Avviare il tono di ricerca

 o 

Interrompere il tono di ricerca

9 Ampliamento del sistema telefonico

Lo standard internazionale **GAP**¹ regola la compatibilità di unità portatili e stazioni base di costruttori differenti. In tal modo è possibile adoperare apparecchi **SWITEL** in combinazione con apparecchi di altri costruttori all'interno di un unico sistema telefonico. Può comunque anche verificarsi la mancata disponibilità di alcune funzioni.

Maggior numero di unità portatili



È possibile registrare complessivamente fino a 5 unità portatili presso la propria stazione base.

Registrazione di unità portatili

Prima di registrare un'unità portatile, passare con la stazione base alla modalità di registrazione.

15 sec. 

Avviare la modalità di registrazione

Registrare quindi l'unità portatile  capitolo 5. Utilizzare ai fini della registrazione il codice PIN attualmente impostato  capitolo 5.

Una volta eseguita la selezione, all'unità portatile è assegnato un numero di chiamata interno. Questo numero di chiamata interno è visualizzato sul display.

¹ **GAP: Generic Access Profile** = Standard per l'interazione di unità portatili e stazioni base di altri costruttori.

Funzioni speciali



Per registrare unità portatili di altri costruttori, leggere prima le rispettive istruzioni per l'uso.

Deregistrazione di unità portatili



La deregistrazione di un'unità portatile da una stazione base è possibile solo attraverso un'altra unità portatile registrata a sua volta alla stazione base in questione.

Unità portatili sono deregistrate tramite menu. Nel capitolo 5 è possibile individuare la posizione nel menu.

Maggior numero di stazioni base

La portata della propria unità portatile può essere aumentata registrando l'apparecchio ad un numero maggiore di stazioni base. È possibile registrarsi contemporaneamente presso 4 stazioni base differenti. Ogni stazione base necessita di una propria presa telefonica. Si può trattare di allacciamenti con lo stesso o differente numero di chiamata.



Per chiamate in corso non è invece possibile compiere un trasferimento da una stazione base all'altra.

10 Funzioni speciali

Procedura di selezione

Il presente telefono funziona sia all'interno di sistemi telefonici analogici (procedura di selezione a impulsi), sia se integrato in moderni sistemi telefonici digitali (procedura di selezione a toni). La procedura di selezione è impostata tramite menu. Nel capitolo 5 è possibile individuare la posizione nel menu.

11 Impianti telefonici interni / Servizi aggiuntivi

Tasto R in impianti telefonici interni

Avendo collegato il telefono ad un impianto telefonico interno, il **tasto R** consente di accedere a tutte le altre funzioni disponibili come per es. trasferimento di chiamata e funzione di richiamata automatica. Si prega di consultare le istruzioni per l'uso del proprio impianto telefonico interno per individuare il tempo flash da impostare al fine di poter usufruire di queste funzioni. Il rivenditore autorizzato è in grado di indicare se il telefono acquistato funzionerà senza alcun problema nel proprio impianto telefonico interno. Il tempo flash è impostato tramite menu. Nel capitolo 5 è possibile individuare la posizione nel menu.

Pausa di selezione

In presenza di impianti telefonici interni è necessario preselezionare un numero di accesso alla rete esterna per ottenere un segnale di linea libera prima di poter compiere una telefonata. Alcuni impianti telefonici interni di vecchia data richiedono del tempo prima di trasmettere il segnale di libero. Per questi impianti telefonici interni è possibile

Impianti telefonici interni / Servizi addizionali

inserirne una pausa di selezione dopo il numero di accesso alla linea esterna in modo da poter proseguire con la selezione del numero senza dover attendere il segnale di libero. La pausa di selezione è inserita premendo il tasto **P** e tenendolo premuto per 3 sec.

Dopo il numero di accesso alla rete esterna si procede, trascorso un determinato intervallo di tempo, con la selezione del numero di chiamata vero e proprio.



La pausa di selezione è memorizzabile anche in sede di immissione di numeri di chiamata nella rubrica telefonica.

Tasto R e servizi addizionali

Il telefono supporta servizi addizionali messi a disposizione dal proprio gestore di rete telefonica come ad es. le funzioni di chiamata in attesa, avviso di chiamata e chiamata a conferenza. Il **tasto R** consente di accedere a questi servizi addizionali. Si prega di consultare il proprio gestore di rete telefonica per ottenere informazioni sul tempo flash necessario all'utilizzo dei servizi addizionali. Rivolgersi al proprio gestore di rete telefonica per ottenere l'abilitazione ai servizi addizionali. Il tempo flash è impostato tramite menu. Nel capitolo 5 è possibile individuare la posizione nel menu.

Visualizzazione del numero di chiamata (CLIP¹)



La visualizzazione del numero di chiamata è un servizio addizionale offerto dal proprio gestore di rete telefonica. Si consiglia di rivolgersi al proprio gestore di rete telefonica per ricevere ulteriori informazioni a riguardo.

A condizione che il collegamento telefonico disponga di questa funzione, l'apparecchio visualizza il numero telefonico del chiamante non appena il telefono squilla. Nel caso in cui il chiamante abbia soppresso la trasmissione del proprio numero di chiamata, appare un'apposita indicazione. Se il numero di chiamata non è visualizzabile, questo non sarà memorizzato nell'elenco chiamate.

Segreteria telefonica integrata nella rete telefonica

Sono numerosi i gestori di rete telefonica che offrono come servizio addizionale una segreteria telefonica integrata nella stessa rete. Se il proprio gestore di rete telefonica mette a disposizione una segreteria telefonica all'interno della propria rete telefonica, un simbolo informa sulla presenza di nuovi messaggi (VMWI²). Questa funzione è disponibile solo nel caso di abilitazione al servizio da parte del gestore di rete telefonica. Per maggiori dettagli a riguardo, rivolgersi al proprio gestore di rete telefonica.

La visualizzazione del simbolo di nuovi messaggi è altresì disattivabile. Vedi capitolo 5, VMWI SPENTO?.

¹ **CLIP**: Calling Line Identification Presentation = Visualizzazione del numero telefonico del chiamante.

² **VMWI**: Visual Message Waiting Indication = Segnalazione ottica di nuovi messaggi.

Segreteria telefonica

12 Segreteria telefonica

Esercizio sulla base



La segreteria telefonica è dotata di guida parlata. Si consiglia di osservare le rispettive istruzioni e indicazioni.

Uscita voce

L'uscita voce della segreteria telefonica è inglese.

Attivare / Disattivare la segreteria telefonica



ANSWER ON / ANSWER OFF



Modificare l'impostazione

Durata di registrazione massima

La durata di registrazione massima è di 19 minuti. Non appena la capacità di memoria risulta esaurita, non è sarà più possibile registrare dei messaggi nuovi. Con memoria piena, sul display compare "F".

Impostare il volume

Il volume è impostabile in 8 livelli.



Impostare il volume (u l-u8)

Ritardo nell'accettazione di chiamate

È possibile scegliere tra 3 - 6 segnalazioni acustiche di chiamata. In più si ha modo di servirsi della funzione di interrogazione preliminare/a distanza gratuita (TIME SAVER). Con questa funzione di interrogazione a distanza/preliminare è possibile verificare gratuitamente la presenza di nuovi messaggi sulla propria segreteria telefonica.

- Se ci sono messaggi nuovi sulla segreteria telefonica, l'apparecchio accetta la telefonata dopo massimo 3 segnalazioni di chiamata.
- Se non ci sono messaggi nuovi sulla segreteria telefonica, l'apparecchio accetta la telefonata solo dopo 5 segnalazioni di chiamata. Riagganciare prima del 5° squillo. In tal modo si evita l'addebito di scatti telefonici.

Ulteriori informazioni sull'interrogazione a distanza ☞ pagina 96.

Impostare il ritardo



RING DELAY IS SET TO 3/4/5/6/TIME SAVER



Modificare l'impostazione

Accettare una chiamata

Anche se la segreteria telefonica ha già risposto ad una chiamata è comunque possibile riprendere la telefonata. La registrazione del messaggio viene in tal caso interrotta.

Segreteria telefonica



Rispondere ad una chiamata

Modalità di risposta

La segreteria telefonica prevede due modalità di risposta. Alla fine dell'annuncio ANNOUNCE ONLY IS OFF è possibile lasciare un messaggio. L'annuncio ANNOUNCE ONLY IS ON è una modalità di solo testo che non prevede la possibilità di lasciare un messaggio.

Selezionare la modalità di risposta



ANNOUNCE ONLY IS OFF /
ANNOUNCE ONLY IS ON



Modificare l'impostazione

Impostare il messaggio di annuncio

La segreteria telefonica offre un messaggio di annuncio preimpostato. Il messaggio di annuncio può essere sostituito da messaggi individuali. Con memoria della segreteria telefonica piena, il dispositivo riproduce automaticamente il messaggio di annuncio ANNOUNCE ONLY IS ON.

Con le seguenti impostazioni è possibile modificare il messaggio di annuncio delle modalità di risposta.

Riprodurre messaggi di annuncio



ANNOUNCEMENT IS...

Registrare messaggi di annuncio

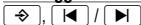

ANNOUNCEMENT IS...



Avviare la registrazione

L'annuncio che si desidera registrare va parlato in modo chiaro e forte rivolti verso il microfono della propria unità portatile.



Concludere la registrazione

A conclusione dell'annuncio, questo è ripetuto ad alta voce.

Riattivare l'annuncio standard



ANNOUNCEMENT IS...



Ripristinare il testo di annuncio standard

Allarme durante i messaggi registrati

Una volta registrato un nuovo messaggio o un promemoria, ogni 10 secondi si avverte un segnale acustico.



MESSAGE ALERT IS OFF / MESSAGE
ALERT IS ON







Modificare l'impostazione

Segreteria telefonica

Riprodurre / Cancellare messaggi registrati

Riprodurre un messaggio

I messaggi registrati sono riprodotti nell'ordine in cui sono registrati. Messaggi nuovi sono riprodotti per primi. Ogni volta che viene riprodotto un messaggio, l'apparecchio indica il giorno della settimana e l'ora di chiamata.

	Riprodurre i messaggi
	Interrompere la riproduzione
	Ripetere il messaggio
2x 	Messaggio precedente
	Messaggio successivo

Cancellare un messaggio

	Riprodurre il messaggio da cancellare
	Cancellare con riproduzione in corso



Una volta cancellati i messaggi non sarà più possibile ripristinarli!

Registrare un promemoria

Un promemoria è un messaggio che è possibile riprodurre e quindi ascoltare allo stesso modo di un messaggio ricevuto.

 ,  / 	MESSAGE RECORDING
	Registrare un promemoria

L'annuncio che si desidera registrare va parlato in modo chiaro e forte rivolti verso il microfono della propria unità portatile.

	Concludere la registrazione
---	-----------------------------





Interrogazione a distanza

È possibile chiamare la propria segreteria telefonica per ascoltare messaggi ricevuti e compiere una serie di funzioni accessorie. Requisito per questa operazione è un telefono abilitato alla selezione a toni.

Codice PIN per l'interrogazione a distanza

La configurazione iniziale del codice PIN è "1234". Si consiglia di modificare in seguito il codice PIN.

Modificare il codice PIN

 ,  / 	REMOTE ACCESS CODE IS 1234
	Avviare la modifica

Scegliere la cifra per la prima posizione.

Segreteria telefonica



Scegliere la cifra



Confermare

Per l'impostazione della seconda, terza e quarta posizione si procede allo stesso modo.

Avviare l'interrogazione a distanza



Selezionare il proprio numero di chiamata



Inserire il codice PIN durante la riproduzione del messaggio

A questo punto è dato modo di svolgere ulteriori funzioni. Tabella delle funzioni a tasti dell'interrogazione a distanza.

Attivazione a distanza della segreteria telefonica



Selezionare il proprio numero di chiamata



Avendo dimenticato di inserire la segreteria telefonica, la chiamata è ricevuta solo dopo 17 segnalazioni acustiche di chiamata.



Inserire il codice PIN durante la riproduzione del messaggio

4

Attivare la segreteria telefonica

A questo punto è dato modo di svolgere altre funzioni.

Funzioni a tasti dell'interrogazione a distanza



L'interrogazione a distanza è interrotta automaticamente se entro 10 secondi non si procede con una immissione.

La seguente tabella offre una vista generale delle funzioni dei singoli tasti.

Tasto	Funzioni
1	Ripetere il messaggio in corso
2x 1	Riprodurre il messaggio precedente
2	Avviare / Interrompere la riproduzione del messaggio
3	Riprodurre il messaggio successivo
4	Attivare / Disattivare la segreteria telefonica
7	Riprodurre il menu Aiuto
0	Cancellare il messaggio in corso di riproduzione
#	Concludere l'interrogazione a distanza

In presenza di problemi

Display della segreteria telefonica

Il display della segreteria telefonica indica lo stato dell'apparecchio.

--	Segreteria telefonica disattivata
00-XX	Costante: segreteria telefonica attivata, numero di messaggi memorizzati Lampeggia: nuovi messaggi
≡≡	Visualizzato con messaggio/annuncio in corso di registrazione
-F	Memoria piena
rR	Interrogazione a distanza

13 In presenza di problemi

Hotline di assistenza tecnica

In presenza di problemi con il telefono, seguire le indicazioni riportate qui di seguito. In caso di problemi tecnici è possibile rivolgersi alla nostra hotline di assistenza tecnica chiamando al numero 0900 00 1675 valido per la Svizzera (spese da rete Swisscom alla data di stampa: CHF 2,60/min). In caso di reclami entro il periodo di garanzia, rivolgersi al rivenditore autorizzato. Il periodo di garanzia ricopre 2 anni.

Domande e risposte

Domande	Risposte
Non è possibile condurre una chiamata telefonica	<ul style="list-style-type: none">- Il telefono non è collegato correttamente oppure presenta un guasto. Utilizzare esclusivamente il cavo di collegamento telefonico fornito.- Provare con un altro telefono se l'allacciamento telefonico in questione è funzionante.- L'alimentatore di rete non è inserito oppure si è in presenza di una caduta di tensione totale.- Le batterie ricaricabili sono scariche o difettose.- La distanza dalla stazione base è troppo grande.- Procedura di selezione non impostata correttamente ☞ pagina 83.

In presenza di problemi

Non è possibile instaurare un collegamento con la stazione base	<ul style="list-style-type: none">- Verificare se la registrazione alla stazione base è stata eseguita con il codice PIN corretto ☞ pagina 83.
Collegamento disturbato, interrotto	<ul style="list-style-type: none">- La distanza dalla stazione base è troppo grande.- Luogo di installazione della stazione base errato.
Il sistema non reagisce più	<ul style="list-style-type: none">- Ripristinare la configurazione iniziale per tutte le funzioni ☞ pagina 82/83.- Estrarre brevemente l'alimentatore di rete dalla presa di corrente.
Le batterie ricaricabili si scaricano piuttosto subito.	<ul style="list-style-type: none">- Le batterie ricaricabili sono scariche o difettose.- Riporre l'unità portatile correttamente nella stazione base. Pulire le superfici di contatto su unità portatile e stazione base con un panno morbido e asciutto.- Posizionare l'unità portatile per la durata di 16 ore nella stazione base.
La visualizzazione del numero di chiamata (CLIP) non funziona	<ul style="list-style-type: none">- La visualizzazione del numero di chiamata è un servizio aggiuntivo offerto dal proprio gestore di rete telefonica. Per maggiori dettagli a riguardo, rivolgersi al proprio gestore di rete telefonica.- Il chiamante ha disattivato la trasmissione del proprio numero di chiamata.
La segreteria telefonica non registra più nessun messaggio / nessun promemoria	<ul style="list-style-type: none">- Verificare che la memoria della segreteria telefonica non sia piena. Cancellare se necessario i messaggi dalla memoria ☞ pagina 96.
Non è possibile compiere un'interrogazione a distanza	<ul style="list-style-type: none">- Verificare se il codice di sicurezza per l'interrogazione a distanza utilizzato è corretto ☞ pagina 96.- Il telefono utilizzato per compiere l'interrogazione a distanza deve passare alla procedura di selezione a toni.

Specifiche tecniche

14 Specifiche tecniche

Specifiche tecniche

Caratteristica	Valore
Standard	DECT¹-GAP²
Alimentazione elettrica (stazione base)	Ingresso: 220/230 V, 50 Hz Uscita: 7.5 V, 320 mA
Alimentazione elettrica (stazione di carica)	Ingresso: 220/230 V, 50 Hz Uscita: 6 V, 150 mA
Portata	Esterno: ca. 300 m Interno: ca. 50 m
Durata di stand-by	fino a 100 ore
Max. autonomia di chiamata	fino a 10 ore
Accumulatori ricaricabili	2 x AAA NiMH 1.2 V
Procedura di selezione	Selezione a toni Selezione a impulsi
Temperatura ambiente ammessa	da 10 °C a 30 °C
Umidità dell'aria relativa ammessa	da 20% a 75%
Funzione flash	100 ms, 300 ms, 600 ms

¹ **DECT**: Digital Enhanced Cordless Telecommunication = Standard per telefoni senza cavo.

² **GAP**: Generic Access Profile = Standard per l'interazione di unità portatili e stazioni base di altri costruttori.

Specifiche tecniche

Configurazione iniziale

Unità portatile

La configurazione iniziale è ripristinata nel menu. A pagina 82 è indicata la posizione da scorrere nel menu.

LINGUA = DEUTSCH	RUBRICA= vuoto
CHIAMATE = vuoto	RIPETI = vuoto
M1, M2 = vuoto	SVEGLIA 1/2 = OFF
MELODIA EST =1	MELODIA INT = 2
VOL.SUONERIA = 3	RISPOSTA AUTO = ON
AMPLIFICATO = AUTO	
ILLUMINAZ. = 10 sec.	

Stazione base

La configurazione iniziale è ripristinata nel menu. A pagina 83 è indicata la posizione da scorrere nel menu.

MELODIA BASE = 2	VOL.SUONERIA = 1
SELEZIONE = TONI	PIN = 0000

Dichiarazione di conformità

Questo apparecchio risponde a quanto disposto dalla Direttiva UE 1999/5/CE concernente le apparecchiature radio, le apparecchiature terminali di telecomunicazioni e il reciproco riconoscimento della loro conformità. La conformità con la Direttiva di cui sopra viene confermata dal marchio CE applicato sull'apparecchio.



Per la dichiarazione di conformità completa si prega di voler usufruire del servizio gratuito di download dal nostro sito Internet www.switel.com.

Consigli per la cura / Garanzia

15 Consigli per la cura / Garanzia

Consigli per la cura

- Pulire le superfici degli apparecchi con un panno morbido e antipilling.
- Non utilizzare mai detersivi o solventi.

Garanzia

Gli apparecchi SWITEL sono costruiti e collaudati in osservanza dei processi di produzione più moderni. L'impiego di materiali selezionati e tecnologie altamente sviluppate sono garanti di una perfetta funzionalità e lunga durata in vita. La garanzia non viene considerata esecutiva qualora la causa del malfunzionamento dell'apparecchio sia riconducibile al gestore della rete telefonica oppure se questa è da attribuirsi ad un impianto telefonico interno interposto. La garanzia non si estende a batterie, accumulatori o batterie ricaricabili utilizzati all'interno degli apparecchi. Il periodo di garanzia ricopre 24 mesi a partire dalla data di acquisto.

Entro il periodo di garanzia si procederà all'eliminazione gratuita di tutti i guasti dovuti a difetti di materiale o produzione. Il diritto di garanzia cessa in caso di interventi da parte dell'acquirente o di terzi. Danni derivanti da un impiego o esercizio non conforme agli usi previsti, a naturale usura, a errato montaggio o errata conservazione, a collegamento o installazione impropri, dovuti a forza maggiore o ad altri influssi esterni non sono coperti da garanzia. In qualità di produttore ci riserviamo il diritto, in caso di reclami, di riparare o sostituire le parti difettose o di rimpiazzare l'apparecchio. Parti o apparecchi sostituiti passano di nostra proprietà. Sono esclusi diritti di risarcimento per danni qualora non siano dovuti a intenzione o colpa grave del costruttore.

Nel caso in cui il presente apparecchio dovesse ciò nonostante presentare un difetto durante il periodo di garanzia, si prega di rivolgersi esclusivamente al negozio di rivendita dell'apparecchio SWITEL assieme al relativo scontrino di acquisto. In base alle presenti disposizioni, tutti i diritti di garanzia dovranno essere fatti valere esclusivamente nei confronti del rivenditore autorizzato. Decorso il termine di due anni dalla data di acquisto e consegna dei nostri prodotti non sarà più possibile fare valere alcun diritto di garanzia.

16 Indice alfabetico

A

Accettare una chiamata, 94
Accettazione di chiamata, 75, 88
Agganciare il ricevitore, 88
Allarme, 95
Ampliamento, 91
Amplificazione acustica, 90
Attivare, 94
Attivazione a distanza, 97

B

Blocco tastiera, 91

C

Cancellare, 85, 87, 96
Cancellare i messaggi, 96
Caricare, 75
Cercare, 91
Chiamate a conferenza, 89
Chiamate interne, 89
CLIP, 93
Codice PIN, 96
Compiere telefonate, 88
Concludere una chiamata, 88
Configurazione iniziale, 82, 83, 101
Consigli per la cura, 102
Contenuto della confezione, 73
Creare, 79, 84

D

Data, 75
Deregistrare, 83
Deregistrazione, 92
Dichiarazione di conformità, 101
Disattivare, 94
Display, 78, 98
Domande e risposte, 98
Durata di conversazione, 90
Durata di registrazione massima, 94

E

Elementi di comando, 76
Elenco chiamate, 80, 86
Eliminare guasti, 98
Esercizio, 77
Esercizio sulla base, 94

F

Funzione di richiamata, 88
Funzione viva voce, 90
Funzioni, 92
Funzioni a tasti, 97

G

Garanzia, 102

H

Hotline di assistenza tecnica, 98

Indice alfabetico

I

Immissione di un nome, 84
Immissione di un testo, 84
Impianti telefonici interni, 92
Impostare il messaggio di annuncio, 95
Indicazioni di sicurezza, 72
Inserire gli accumulatori, 75
Interrogazione a distanza, 96

L

Lingua, 94
Lingua di display, 75

M

Melodia di suoneria, 81, 83
Memorizzare, 87
Menu principale, 79
Messa in funzione, 73
Messaggi, 86, 96
Messaggi di annuncio, 95
Messaggi di display, 86
Modalità di stand-by, 78
Modalità ECO, 76
Modi di scrittura, 77
Modifica del codice PIN, 96
Modificare, 85

O

Ora, 75

P

Paging, 91
Pausa di selezione, 92
Presenza di collegamento per auricolare, 77
Problemi, 98
Procedura di selezione, 83, 92

R

Registrare, 83, 95
Registrare un promemoria, 96
Registrazione, 91
Riduzione delle radiazioni, 76
Ripetizione di chiamata, 81, 88
Riprodurre, 95, 96
Risparmio di addebiti, 94
Ritardo, 94
Rubrica telefonica, 80, 84, 88

S

Salvare, 79, 84
Segreteria telefonica, 94
Segreteria telefonica integrata
nella rete telefonica, 93
Selezionare, 88
Selezionare la modalità di risposta, 95
Selezione a impulsi, 83, 92
Selezione a toni, 83, 92
Selezione diretta, 86, 89
Servizi aggiuntivi, 92
Silenziamiento, 91
Silenziamiento del microfono, 91
Simboli, 78
Simboli di display, 78
Specifiche tecniche, 100
Stato di carica delle batterie ricaricabili, 75
Stazione base, 74, 92
Stazione di carica, 74
Struttura dei menu, 79
Sveglia, 81

T

Tasto R, 92, 93
Trasferimento di chiamata, 89

U

Unità portatile, 91

V

Visualizzazione del numero
di chiamata, 86, 93

VMWI, 93

Voci della rubrica telefonica, 79

Voci nella rubrica telefonica, 84

Volume, 94

Volume del ricevitore, 90

Volume di squillo, 90

Contents

1	Safety Information	108
2	Preparing the Telephone	109
3	Operating Elements	112
4	Preliminary Information	113
5	Menu Structure	116
6	Phone Book	120
7	Call Log	122
8	Telephoning	124
9	Extending the Telephone System	127
10	Special Functions	127
11	PABX / Supplementary Services	128
12	Answering Machine	129
13	In Case of Problems	133
14	Technical Properties	135
15	Maintenance / Guarantee	137
16	Index	138

Safety Information

1 Safety Information

Please read this operating instruction manual thoroughly.

Intended use

The telephone is suitable for telephoning within a public telephone network system. Any other use is considered unintended use. Unauthorised modification or reconstruction is not permitted. Under no circumstances open the device or complete any repair work yourself.

Installation location

Prevent excessive exposure to smoke, dust, vibration, chemicals, moisture, heat and direct sunlight.

Do not use the handset in potentially explosive areas.

Power adapter plug



Attention: Only use the power adapter plug supplied because other power supplies could damage the telephone. Ensure access to the power adapter plug is not obstructed by furniture or such.

Rechargeable batteries



Attention: Never throw batteries into a fire. Only use batteries of the same type. Pay attention to correct polarity. Incorrect polarity of the batteries represents a risk of explosion during charging.

Power failure

The telephone cannot be used to make calls in the event of a power failure. Always keep a cord connected telephone which operates without an external power supply available in case of emergency situations.

Medical equipment



Attention: Never use the telephone in the vicinity of medical equipment. Effects on such equipment cannot be fully ruled out.

Hearing aid compatible

The telephone is compatible with most popular hearing aids on the market. However, it cannot be guaranteed that all hearing aids will work perfectly.

DECT¹ telephones can cause an unpleasant humming sound in hearing aids.

¹ **DECT:** Digital Enhanced Cordless Telecommunication = Standard for cordless telephones.

Preparing the Telephone

Disposal

In order to dispose of your device, take it to a collection point provided by your local public waste authorities (e.g. recycling centre). The adjacent symbol indicates that the device must not be disposed of in normal domestic waste! According to laws on the disposal of electronic and electrical devices, owners are obliged to dispose of old **electronic and electrical devices** in a separate waste container.

Batteries must be disposed of at the point of sale or at the appropriate collection points provided by the public waste authorities.

Packaging materials must be disposed of according to local regulations.



2 Preparing the Telephone

Safety information



Attention: It is essential to read the Safety Information in Chapter 1 before starting up.

Checking the package contents

The package contains:

Content	Model DCT627x ¹			
	6271	6272	6273	6274
Base station with power adapter plug	1	1	1	1
Charging station with power adapter plug	-	1	2	3
Handset	1	2	3	4
Telephone connection cable	1	1	1	1
Batteries	2	4	6	8
Operating instructions	1	1	1	1

Connecting the base station



Attention: Position the base station at least 1 m away from other electronic devices, otherwise there is a risk of mutual disturbance.

Connect the base station as illustrated in the diagram. For reasons of safety, only use the power adapter plug and telephone connection cable supplied with the product.

¹ Visit www.switel.com to find out whether the telephone/telephone set is already available.

Preparing the Telephone

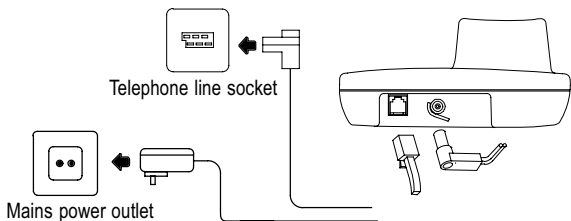

For the base station, use the power adapter plug labelled with no. KG2B-075-0320D and output data 7.5 V, 320 mA.

Connecting the charging station¹

Connect the charging station as illustrated in the diagram. For safety reasons, only use the power adapter plug supplied.

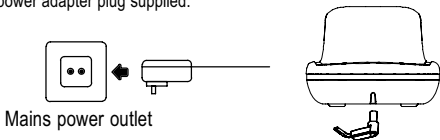

For the charging station, use the power adapter plug labelled with output data 6 V, 150 mA.

Inserting the batteries

Insert the batteries in the open battery compartment. Only use batteries of the type AAA NiMH 1.2 V. Pay attention to correct polarity. Close the battery compartment cover.

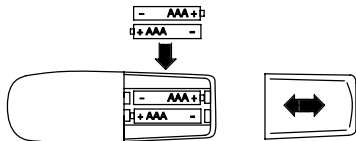

¹ Only applies to telephone sets with at least two handsets; ☞ "Checking the package contents" on Page 109.

Preparing the Telephone

Charging the batteries



Before the handset is used for the first time, insert it in the base station/charging station for **at least** 16 hours.

[When the handset is correctly inserted in the base station / charging station, an acoustic signal issued.] [When the handset is correctly inserted in the base station / charging station, the charge control lamp lights up.] The handset warms up during the charging process. This is normal and does not represent a risk. Do not charge the handset with charging units from other manufacturers. The current **battery charge status** is indicated in the display:



Full



Half empty



Low



Empty

Setting the display language

Select the required language (also refer to "Menu Structure"):



> MOBILTEIL > SPRACHE >...



> HS SETTINGS > LANGUAGE >...

The German, French, Italian and English languages are available for selection.

Setting the time and date on the handset

The time and date are set via the menu. Refer to Page 117 for the sequence of menu option selections.

Automatic answering

If the Auto Talk function is activated, an incoming call is taken when the handset is removed from the base station. The automatic answering function is activated and deactivated using the menu. Refer to Page 118 for the sequence of menu option selections.

Private branch exchanges

The information on Page 128 explains how to install your telephone in a private branch exchange.

Low-radiation operation (ECO mode)

The level of radiation is considerably lower than that of standard DECT cordless telephones when in Standby mode when the handset is in the base station.

In talk mode, radiation is reduced (depending on the distance between the handset and base station).



Operating Elements

3 Operating Elements

The buttons in this operating manual are subsequently depicted with a uniform contour. Therefore, slight deviations in the appearance of the symbols on the telephone buttons compared to those depicted here are possible.

Handset

- 1 Loudspeaker
- 2 LCD display
- 3 Menu / OK button
- 4 Quick dial button M2
- 5 Headset connection
- 6 Delete /R button
- 7 Handsfree button
- 8 Digit keys
- 9 # button / Key lock
- 10 Microphone
- 11 Pause button
- 12 * button / Internal call
- 13 Call / On-hook button
- 14 Scroll down / Call log
- 15 Quick dial button M1
- 16 Scroll up / Redial
- 17 LED

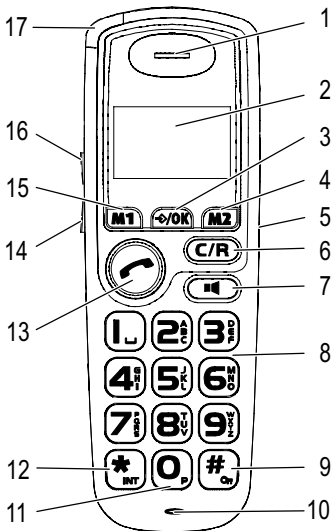

Connecting the headset

The headset can be connected using a connection port located on the right-hand side of the handset. Use a 2.5 mm stereo phone jack to connect the headset. There is no guarantee the headset will function properly.

Preliminary Information

Base station



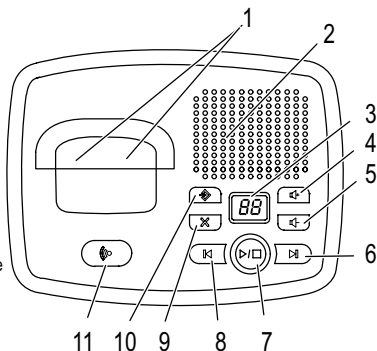





- 1 Charging contacts
- 2 Loudspeaker
- 3 LC display
- 4 Volume +
- 5 Volume -
- 6 Move forward in menu /
Skip to next message
- 7 Play / Stop /
Confirm/Cancel setting
- 8 Move back in menu /
Skip to previous message
- 9 Delete message/
outgoing message
- 10 Change menu/setting
- 11 Paging button



4 Preliminary Information

















This chapter provides basic information on using the operating instruction manual and the telephone.

Description of operating sequences in the manual

Display	Description
	Displays the contour of buttons
	Press the button depicted briefly
2 sec. 	Press the button depicted for 2 seconds
	Enter digits or letters
	Handset rings
	Remove the handset from the base station
	Place the handset in the base station
	Depicts text in the display
	Depicts icons in the display

Preliminary Information

Icons and texts in the handset display

Icon	Description
	On: Battery charge capacity indicator. Flashing: The batteries must be charged. Run-through segments: The batteries are being charged;  Page 111.
1	Internally assigned call number of the handset;  Page 127.
12--59	Displays the time;  Page 117.
	A call is currently being made  Page 124.
	You have accessed the call log. New calls have been registered in the call log;  Page 122.
	The ringing tone has been switched off;  Page 117.
	The handsfree facility is activated;  Page 126.
	The key lock function is activated;  Page 126.
	The alarm function is enabled.
MESSAGE WAITING	Answering machine provided in the telephone network. VMWI ¹ - Supplementary service offered by telephone network providers;  Page 129.
	The connection to the base station is good.

Standby mode











All descriptions in this operating manual assume that the handset is in Standby mode which is the case when you are not talking on the phone and if a menu is not open. Press the  button, several times if necessary, to enable the Standby mode.

¹ **VMWI: Visual Message Waiting Indication** = Visual indicator that new messages have been recorded.

Preliminary Information

Navigating in the menu

All the functions can be accessed via the various menus. Refer to Menu Structure Page 116 for information on how to access each respective function.









	Open the main menu
 or 	Select a submenu
	Open the submenu
 or 	Select a function
	Open the function
 or 	Select a setting
	Use the digit keys to enter numbers or letters
	Confirm the input
C	Move one level back
C several times, if necessary	Cancel the programming and saving processes and return to Standby mode



Every process is automatically cancelled if there is no input within 15 seconds.

Creating phone book entries - example





The way in which to navigate through the menus and select settings is explained by means of the example **Creating phone book entries**. Proceed as in this example for all the settings.

	Open the main menu
PHONEBOOK 	Open the phone book
	Skip selection of entries
ADD NEW ENTRY 	Select the submenu and confirm it
 	Enter the name (max. 12 characters) and confirm it
 	Enter the phone number (max. 24 digits) and confirm it





Menu Structure



5 Menu Structure



Main menu

Press the  button to open the main menu. Then move to and select an entry using the  or  button and confirm your selection by pressing the  button. Further information on the menu and operation;  Chapter 4.

PHONEBOOK, select an entry /, skip selection 

ADD NEW ENTRY	NAME  ¹	NUMBER 
EDIT	NAME 	NUMBER 
DELETE RECORD	CONFIRM?	
DELETE ALL	CONFIRM?	

CALL LOG², select an entry /, skip selection 

SAVE TO PHONEBOOK	NAME 	NUMBER 
DELETE RECORD	CONFIRM?	
DELETE ALL	CONFIRM?	

¹ Letters are also imprinted on the digit keys. Letters, digits and special characters are entered by pressing the relevant key the respective number of times.

² The call number display (**CLIP**³) is required to be able to display and store phone numbers in call log. The caller number display (CLIP) is a supplementary service offered by your telephone network provider. Contact your network provider for further information. For further information on the CLIP feature, refer to  Page 122.

³ **CLIP**: Calling Line Identification Presentation = Displays the caller's phone number.

Menu Structure

REDIAL, select entry /, skip selection

SAVE TO PHONEBOOK	NAME	NUMBER
DELETE RECORD	CONFIRM?	
DELETE ALL	CONFIRM?	



ALARMS

ALARM 1	CLEAR		
	SET	TIME	CONFIRM?
ALARM 2	CLEAR		
	SET	TIME	CONFIRM?

HS SETTINGS

RINGER MELODY	EXTERNAL CALL MELODY	MELODY 1-10
	INTERNAL CALL MELODY	MELODY 1-10
HS RINGER VOLUME	VOLUME 1-5, OFF	
DATE/TIME SETTINGS	DATE/TIME	DATE
		CONFIRM?
		TIME
		CONFIRM?
	DATE/TIME FORMAT	DATE



Menu Structure

		<ul style="list-style-type: none"> ▶ DD/MM ▶ MM/DD TIME  ▶ ▶ 12 HR ▶ 24 HR 	
	BOOST MODE	ON	LOW
			MEDIUM
		AUTO	HIGH
		OFF	
KEY TONE	ON/OFF		
DISPLAY CONTRAST	LEVEL 1-8		
HANDSET NAME			
BACKLIGHT SETTING	5-30 SECONDS		
AUTO TALK	ON/OFF		
LANGUAGE ¹			
SET DEFAULT	CONFIRM?		



¹For the languages available, refer to  Chapter 2.

Menu Structure

BS SETTINGS, INPUT PIN ¹

BASE RINGER MELODY	MELODY 1-5
HS RINGER VOLUME	VOLUME 1-5, OFF
CHANGE PIN ¹	NEW PIN  CONFIRM PIN 
DIAL MODE	TONE
	PULSE
FLASH TIME	SHORT
	MEDIUM
	LONG
VMWI ²	VMWI OFF?
SET DEFAULT	CONFIRM?

REGISTRATION

REGISTER	INPUT PIN 
SELECT BASE	BASE 1-4
REMOVE HANDSET	INPUT PIN  HANDSET 1-4
REMOVE BASE	BASE 1-4

¹ The default PIN code is "0000".

² **VMWI: Visual Message Waiting Indication** = Visual indication of new messages.

Phone Book





6 Phone Book

You can use the phone book to store up to 100 phone numbers together with the associated names.

- Always enter the area access code with the phone numbers so that incoming local calls can also be assigned to a phone book entry.
- When the memory capacity is used up, the message **MEMORY FULL** appears when an attempt is made to store another number. To create space, an existing entry must first be deleted.
- The phone book entries are arranged alphabetically.

Entering names











Letters are also imprinted on the digit keys. Letters, digits and special characters are entered by pressing the relevant key the respective number of times.

	Enter a space
	Delete characters
 or 	Moves the cursor



To enter the same letter twice, press the button to enter the letter. Wait until the cursor skips one position forwards. Enter the letter again.

Creating phone book entries

	Open the main menu
 	Open the phone book
	Skip selection of entries
 	Select the submenu and confirm it
 	Enter the name (max. 12 characters) and confirm it
 	Enter the phone number (max. 24 digits) and confirm it

Phone Book

Editing phone book entries

	Open the main menu
PHONEBOOK	Open the phone book
or ,	Select and confirm an entry
or , EDIT	Select the submenu and confirm it
,	Change the name and confirm it
,	Change the phone number and confirm it

Deleting phone book entries

Deleting an entry

	Open the main menu
PHONEBOOK	Open the phone book
or ,	Select and confirm an entry
or , DELETE RECORD	Select the submenu and confirm it
CONFIRM? , or C	Confirm the deleting process or cancel it

Deleting all entries

	Open the main menu
PHONEBOOK	Open the phone book
	Skip selection of entries
or , DELETE ALL	Select the submenu and confirm it
CONFIRM? , or C	Confirm the deleting process or cancel it

Call Log

Quick dial

You can assign one phone number each to the quick dial buttons **M1** and **M2**.

Storing phone numbers as quick dial numbers

Enter the phone number or select one from the phonebook, redialling list or call log.

3 sec. **M1** or **M2**

Assign the selection to the corresponding one-touch dialling button



Entries assigned to the quick dial buttons cannot be deleted, they must be overwritten.

7 Call Log

A total of 20 calls are stored in the calls log.



The caller number display (**CLIP**¹) is a supplementary service offered by your telephone network provider. The caller's number appears in the display if the service is offered by your telephone network provider. Contact your network provider for further information.

Messages in the display:

OUT OF AREA	The phone number is received only partially or with errors.
LONG DISTANCE	Information related to the phone number is not available. This could signify an international call.
PRIVATE	The caller has suppressed the transmission of their phone number.

Displaying numbers in the call list

, or

Display the call log and select an entry











Press the button, several times if necessary, to switch between the "Name", "Number" and "Received time/date" displays.

¹ **CLIP**: Calling Line Identification Presentation = Displays the caller's phone number.

Call Log

Storing a phone number in the calls log in the phone book

A phone number in the call list can be stored in the phone book directly.









 ,  or 	Display the call log and select an entry
	Open the menu
 or  <input type="text" value="SAVE TO PHONEBOOK"/> , 	Select and confirm the submenu
 , 	Enter the name (max. 12 characters) and confirm it
 , 	Change the phone number and confirm it









As soon as the phone number in the phone book has been saved together with a name, the name entered appears in the call list.

Deleting phone numbers from the call list

Deleting individual phone numbers

 ,  or 	Display the call log and select an entry
	Open the menu
 or  , <input type="text" value="DELETE RECORD"/> 	Select the submenu and confirm it
<input type="text" value="CONFIRM?"/> ,  or <input type="text" value="C"/>	Confirm the deleting process or cancel it

Deleting all phone numbers

	Open the call log
	Open the menu
 or  , <input type="text" value="DELETE ALL"/> 	Select the submenu and confirm it
<input type="text" value="CONFIRM?"/> ,  or <input type="text" value="C"/>	Confirm the deleting process or cancel it

Telephoning

8 Telephoning

Taking a call

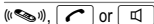

Take the call

Ending a call



End the call

Making a call



Enter the phone number (max. 24 digits)



Deletes the last digit if incorrect

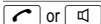

Dials the phone number



It is also possible to press the Call button first to obtain the dialling tone for an outside line. The digits then entered are dialled immediately. It is not possible to correct wrong digits individually using this dialling procedure.

Redialling

The telephone stores the last 10 phone numbers dialled in a redialling list.



Open the redialling list and select an entry



Dial the number

Editing phone numbers on the redialling list is identical to editing phone numbers on the call log; Chapter 7.

Calling back calls received

Your telephone stores 20 phone numbers in a call log.



Display the call log and select an entry



Dial the number

Dialling numbers from the phone book

Phone numbers must have been stored in the phone book for this function;

Chapter 6.



Open the main menu



Open the phone book



Select an entry and dial the number

Quick dial

Phone numbers must have been stored in the phone book for this function;

Chapter 5.

3 sec. **M1** or **M2**





Execute the quick dial call

Telephoning





Internal calls¹

Making internal calls

There must be two or more handsets (HS1, HS2, ...) registered on your base station in order to make internal calls free of charge.

HS1: 3 sec. 	Activate the internal call function
e.g. 	Dial the internal call number of the handset required
HS2: 	Other handset answers the call
HS1/HS2: 	End the internal call

Forwarding external calls internally





HS1: 3 sec. 	During an external call
e.g. 	Dial the number of the internal handset
HS2: 	Other handset answers the call
HS1: 	Forward the call



If the handset called does not answer, the external call is returned to the calling handset after 30 seconds.





Making conference calls

An external call can be transferred to another internal handset for a conference call.

HS1: 3 sec. 	During an external call
e.g. 	Dial the number of the internal handset
HS2: 	Other handset answers the call
HS1: 3 sec. 	Start the conference
HS1 / HS2: 	End the conference

Setting the base station ringing volume

Change the setting on the base station as follows.

 ,  / 	BASE RINGER IS 0, 1, 2, 3, 4, 5
	Change the setting

Setting the receiver volume

The volume can be adjusted to one of 5 levels during a call.

 or 	Select a volume level
--	-----------------------

¹ Internal calls are only possible when at least two handsets are registered in the system;  "Checking the contents of the package" on Page 109.

Telephoning

Boost mode

There are further boosted volume levels in addition to the 5 basic levels;

☞ Chapter 5. Activate the boost level required to be able to use it.

BOOST MODE	Function
OFF	Only volume levels 1-5 are available
ON, LOW	Additional low boost can be selected
ON, MEDIUM	Additional low and medium boost can be selected
ON, HIGH	Additional low, medium and high boost can be selected
AUTO	Press  for 2 sec., the loudest setting is automatically selected

Displaying the duration of a call

The duration of a call is displayed in hours, minutes and seconds during the call.

Handsfree

This function is used to listen to the caller via the loudspeaker.



Enables handsfree conversation



Disables handsfree conversation

Muting the microphone in the handset

The microphone in the handset can be activated and deactivated during a telephone conversation.

3 sec. 

Switch the microphone off (muting)

3 sec. 

Switch the microphone on

Key lock

The key lock feature prevents functions assigned to buttons being activated accidentally.

3 sec. 

Locks the keys





Incoming calls can still be taken in the normal way even when the key lock function is activated.

3 sec. 

Unlocks the keys

Searching for the handset (Paging)

If you have mislaid your handset, you can sound a paging tone to find it.

Base station , 

Sound the paging tone

Extending the Telephone System

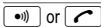

or



Stops sounding the paging tone

9 Extending the Telephone System

The internationally approved **GAP**¹ standard regulates the compatibility of handsets and base stations from different manufacturers. As a result, it is possible to integrate SWITEL devices and devices from other manufacturers together in one telephone system. It is possible, however, that some functions are not available.

Multiple handsets

Up to 5 handsets can be registered on the base station.

Registering handsets

Before starting to register a handset, switch the base station to Registration mode.

15 sec.

Enables the Registration mode

Now register the handset; Chapter 5.

Use your current PIN code, Chapter 5, to register it.

The handset is automatically assigned an internal call number following registration.

The internal call number appears in the display.



To register handsets from other manufacturers, please refer to the operating manual supplied with them.

Deregistering handsets



A handset can only be deregistered from a base station by using another handset registered to the same base station.

Handsets are deregistered via the menu. Chapter 5 indicates the position in the menu.

Multiple base stations

You can increase the range of your handset by registering it on several base stations. The handset can be registered on up to 4 different base stations simultaneously. Each base station requires its own telephone line socket. Connections can be used with the same call number or with different ones.



Calls in progress cannot be transferred from one base station to another.

10 Special Functions

Dialling mode

The telephone can be operated in analogue exchanges (PULSE mode) as well as new,

¹ **GAP: Generic Access Profile** = Standard for the interoperation of handsets and base stations from different manufacturers.

PABX / Supplementary Services

digital exchanges (TONE/DTMF mode). The dialling mode is controlled via the menu. Chapter 5 indicates the position in the menu.

11 PABX / Supplementary Services

R-button on private branch exchanges

If the telephone is connected to a private branch exchange, functions such as transferring calls and automatic call back can be used via the **R button**. Refer to the operating manual provided with your private branch exchange as to which Flash time must be set in order to use these functions. The sales outlet where you purchased the exchange can provide information as to whether the telephone will work properly with the exchange. The Flash time is set using the menu. Chapter 5 indicates the position in the menu.

Dialling pause

When using private branch exchanges, it is necessary to dial an access code to obtain the dialling tone for an outside line. When using some older private branch exchanges, it takes a little time before the dialling tone becomes audible. In the case of such private branch exchanges, a dialling pause can be inserted after the number for an outside line in order to continue dialling directly without having to wait for the dialling tone. The dialling pause is inserted by pressing and holding the **P** button for 3 seconds.

The actual phone number is dialled a certain time after the number for an outside line.



The dialling pause can also be entered with the phone numbers in the phone book.

R-button and supplementary services

Your telephone supports supplementary services provided by your telephone network provider, such as brokering, call waiting and conference facilities. These supplementary services can be used by implementing the **R button**. Please contact your telephone network provider regarding which Flash time must be set to use the supplementary services. Contact your telephone network provider with regard to enabling supplementary services. The Flash time is set using the menu. Chapter 5 indicates the position in the menu.

Caller number display (CLIP¹)



The caller number display (CLIP) is a supplementary service offered by your telephone network provider. Contact your network provider for further information.

If this function is available with your telephone line, the number of the caller appears in the display when the phone rings. If the caller has suppressed transmission of his phone number, the corresponding message appears in the display. The phone number

¹ **CLIP**: Calling Line Identification Presentation = Displays the caller's phone number.

is not displayed and, as a result, is not stored in the call list.

Answering machine in the telephone network

An answering machine in the telephone network is a supplementary service offered by many telephone network providers. If your telephone network provider offers an answering machine in the telephone network for you, an icon on the display informs you of new messages received (VMWI²). This function can only be used when your telephone network provider actually offers the service. Contact your network provider for further information.

You can switch the new message indicator icon off. Refer to Chapter 5, VMWI OFF?.

12 Answering Machine

Operating via the base station



The answering machine is equipped with a vocal operator guidance. Observe the instructions and information provided.

Language

The answering machine communicates in English.

Switching the answering machine on/off



ANSWER ON / ANSWER OFF



Change the setting

Maximum recording time

The maximum recording time is 19 minutes. When the memory capacity for new messages is exhausted, no further messages are recorded. When the memory is full, "F" appears in the display.

Setting the volume

The volume can be set to one of 8 different levels.



Change the volume (u l-uβ)

Ringling delay for taking a call

You can select from 3 to 6 rings. In addition, the TIME SAVER setting is also available for pre-remote access free of charge. The toll-saving pre-remote access feature can be used to check whether new messages have been received on your answering machine from a distant telephone.

- If new messages have been recorded on your answering machine, your call is taken after 3 rings at the latest.

² VMWI: Visual Message Waiting Indication = Visual indicator that new messages have been recorded.

Answering Machine

- If no new messages have been recorded on your answering machine, your call is taken after 5 rings. End the call before the 5th ring. This means that no charges ensue.

For further information on remote access, refer to  Page 132.

Setting the delay



RING DELAY IS SET TO 3/4/5/6/TIME
SAVER



Change the setting

Taking a call being recorded

It is possible to take a call even if the answering machine has already begun to take it. Recording of the message is stopped in this case.



Take the call

Answering modes

The answering machine is provided with two, pre-recorded outgoing messages. After the ANNOUNCE ONLY IS OFF outgoing message has been played, the caller can leave a message. The ANNOUNCE ONLY IS ON message indicates that the outgoing message is purely informative and the caller cannot leave a message.

Selecting the answering mode



ANNOUNCE ONLY IS OFF /
ANNOUNCE ONLY IS ON



Change the setting

Recording your own outgoing message

The answering machine is provided with a pre-recorded outgoing messages (OGM). The OGM can be replaced with your own text. When the answering machine's memory is full, the ANNOUNCE ONLY IS ON message is automatically played to callers.

Proceed as follows to change the answering mode outgoing message.

Playing the outgoing message



ANNOUNCEMENT IS...

Recording outgoing messages



ANNOUNCEMENT IS...



Start recording

Now speak your message clearly and precisely in the microphone.



End recording

On ending the message, it is played back.

Answering Machine

Reactivating the pre-recorded message



ANNOUNCEMENT IS...



Restore the standard outgoing message

Message waiting alarm

If a new message or a memo has been recorded, an acoustic signal is issued every 10 seconds.



MESSAGE ALERT IS OFF / MESSAGE ALERT IS ON



Change the setting

Playing/Deleting recorded messages

Playing the messages

The recorded messages are played back in the sequence they were recorded. New messages are played first. The weekday and time of recording are announced for the respective message prior to being played.



Play messages



Stop playback



Repeat playback of current message



Play the previous message



Play the next message

Deleting a message



Play the message to be deleted



Delete message while it is being played



Messages which have been deleted cannot be restored!

Recording a memo

A memo is a message left for other machine users and can be played in the same way as an incoming message.



MESSAGE RECORDING



Record a memo

Now speak your message clearly and precisely in the microphone.



End recording

Answering Machine





Remote access

You can call your answering machine from another telephone to play messages or execute other functions. A condition is that you use a telephone which implements tone dialling.



PIN code for remote access

The default setting of the PIN code is "1234". It is recommended to change the default PIN code.

Changing the PIN code



 ,  / 	REMOTE ACCES CODE IS 1234
	Initiate change

Selecting the digit for the first position.

 / 	Select the digit
	Confirm it





The procedure to set the second, third and fourth digit is identical.

Starting remote access

	Dial your own phone number
	Enter the PIN code while the OGM is playing

You can now execute other functions;  Key function assignment for remote access.

Remote activation of the answering machine

	Dial your own phone number
	If you forgot to switch your answering machine on, your call is taken after 17 rings.
	Enter the PIN code while the OGM is playing
	Activate the answering machine

You can now execute other functions.

Key function assignment for remote access

	Every remote access process is automatically cancelled if there is no input within 10 seconds.
---	--

The following table provides an overview of the respective functions assigned to the individual buttons.

Button	Function
--------	----------

In Case of Problems

1	Repeat the message currently playing
2x 1	Play the previous message
2	Start/Stop playback of a message
3	Play the next message
4	Switch the answering machine on/off
7	Play the Help menu
0	Delete the message during playback
#	End remote access

Answering machine display

The answering machine's display indicates the unit's status.

--	The answering machine is switched off
00-XX	On: Answering machine is switched on, Number of messages stored Flashing: New messages
≡≡	Appears when a message / outgoing message is being recorded
-F	Memory is full
rR	Remote access

13 In Case of Problems

Service Hotline

Should problems arise with the telephone, please refer to the following information first. In the case of technical problems, you can contact our hotline service, Tel. 0900 00 1675 within Switzerland (Swisscom fees at time of going to print: CHF 2.60/min). In the case of claims under the terms of guarantee, please contact your sales outlet. The period of guarantee is 2 years.

In Case of Problems

Problems and solutions

Problems	Solutions
No telephone calls possible	<ul style="list-style-type: none">- The telephone is not connected properly or is defective. Only use the telephone connection cable supplied.- Test whether the telephone connection is in order by using another telephone.- The power adaptor plug is not plugged in or there is a complete power failure.- The rechargeable batteries are empty or defective.- The handset is too far from the base station.- The wrong dialling mode is set; ☞ Page 119.
No connection to base station possible	<ul style="list-style-type: none">- Check that the handset has been registered on the base station with the correct PIN code; ☞ Page 119.
Connection is disturbed or cut off	<ul style="list-style-type: none">- The handset is too far from the base station.- The base station is in an unsuitable location.
The system no longer responds	<ul style="list-style-type: none">- Reset all the functions to their default settings; ☞ Page 118/119.- Disconnect the power adaptor plug briefly from the power socket.
The batteries are empty within a short time	<ul style="list-style-type: none">- The batteries are empty or defective.- Place the handset in the base station properly. Clean the contact surfaces on the handset and base station with a soft, dry cloth.- Place the handset in the base station for 16 hours.
The caller number display (CLIP ¹) does not function	<ul style="list-style-type: none">- The caller number display (CLIP) is a supplementary service offered by your telephone network provider. Contact your network provider for further information.- The caller has suppressed the transmission of their phone number.

Technical Properties

The answering machine does not record any messages/memos

- Check whether the answering machine memory is full. Delete messages from the memory, if necessary; ☞ Page 126.

No remote access functions can be executed

- Check that the correct security code has been entered for remote access; ☞ Page 132.
- The telephone used for remote access must be set to tone dialling.

14 Technical Properties

Technical data

Feature	Value
Standard	DECT1-GAP²
Power supply (base station)	Input: 220/230 V, 50 Hz Output: 7.5 V, 320 mA
Power supply (charging station)	Input: 220/230 V, 50 Hz Output: 6 V, 150 mA
Range	Outdoors: Approx. 300 m Indoors: Approx. 50 m
Standby time	Up to 100 h
Max. talk time	Up to 10 h
Rechargeable batteries	2 x AAA NiMH 1.2 V
Dialling mode	Tone dialling mode Pulse dialling mode
Permissible ambient temperature	10°C to 30°C
Permissible relative humidity	20% to 75%
Flash function	100 ms, 300 ms, 600 ms

¹ **DECT**: Digital Enhanced Cordless Telecommunication = Standard for cordless telephones.

² **GAP**: Generic Access Profile = Standard for the interoperation of handsets and base stations from different manufacturers.

Technical Properties

Default settings

Handset

The default settings can be restored via the menu. Refer to Page 118 for the sequence of menu option selections.

LANGUAGE = GERMAN	PHONEBOOK= Empty
CALL LOG = Empty	REDIAL = Empty
M1, M2 = Empty	ALARMS 1/2 = OFF
EXTERNAL CALL MELODY =1	INTERNAL CALL MELODY = 2
HS RINGER VOLUME = 3	AUTO TALK = ON
BOOST MODE = AUTO	
BACKLIGHT SETTING = 10 sec.	

Base station

The default settings can be restored via the menu. Refer to Page 119 for the sequence of menu option selections.

BASE RINGER MELODY = 2	HS RINGER VOLUME = 1
DIAL MODE = TONE	PIN = 0000

Declaration of Conformity

This device fulfils the requirements stipulated in the EU directive: 1999/5/EC directive on radio equipment and telecommunications terminal equipment and the mutual recognition of their conformity. Conformity with the above mentioned directive is confirmed by the CE symbol on the device.

To view the complete Declaration of Conformity, please refer to the free download available on our web site www.switel.com.



15 Maintenance / Guarantee

Maintenance

- Clean the housing surfaces with a soft, fluff-free cloth.
- Do not use any cleaning agents or solvents.

Guarantee

SWITEL equipment is produced and tested according to the latest production methods. The implementation of carefully chosen materials and highly developed technologies ensure trouble-free functioning and a long service life. The terms of guarantee do not apply where the cause of equipment malfunction is the fault of the telephone network operator or any interposed private branch extension system. The terms of guarantee do not apply to the batteries or power packs used in the products. The period of guarantee is 24 months from the date of purchase.

All deficiencies related to material or manufacturing errors within the period of guarantee will be redressed free of charge. Rights to claims under the terms of guarantee are annulled following tampering by the purchaser or third parties. Damage caused as the result of improper handling or operation, normal wear and tear, incorrect positioning or storage, improper connection or installation or Acts of God and other external influences are excluded from the terms of guarantee. In the case of complaints, we reserve the right to repair defect parts, replace them or replace the entire device. Replaced parts or devices become our property. Rights to compensation in the case of damage are excluded where there is no evidence of intent or gross negligence by the manufacturer.

If your device does show signs of a defect within the period of guarantee, please contact the sales outlet where you purchased the SWITEL device, producing the purchase receipt as evidence. All claims under the terms of guarantee in accordance with this agreement can only be asserted at the sales outlet. No claims under the terms of guarantee can be asserted after a period of two years from the date of purchase and hand-over of the product.

Index

16 Index

A

- Alarm, 117, 131
- Announcement, 130
- Answering machine, 129
- Answering machine in the telephone network, 129

B

- Base station, 109, 127
- Battery charge status, 111
- Boost mode, 126

C

- Call back, 124
- Call log, 116, 122
- Caller number display, 122, 128
- Change the PIN code, 132
- Charging, 111
- Charging station, 110
- CLIP, 128
- Conference calls, 125
- Connecting the headset, 112
- Creating, 115, 120

D

- Date, 111
- Declaration of Conformity, 136
- Default settings, 118, 119, 136
- Delay, 129
- Deleting, 121, 123, 131
- Deleting messages, 131
- Deregistration, 119, 127
- Dialling, 124
- Dialling mode, 119, 127
- Dialling pause, 128
- Display, 114, 133
- Display icons, 114
- Display language, 111
- Display messages, 122

E

- ECO mode, 111
- Editing, 121
- Ending a call, 124
- Entering names, 120
- Entering text, 120
- Extending, 127

F

- Forwarding calls, 125
- Functions, 127

G

- Guarantee, 137

H

- Handset, 127
- Handsfree, 126

I

- Icons, 114
- Inserting the batteries, 110
- Internal calls, 125

K

- Key function assignment, 132
- Key lock, 126

L

- Language, 129
- Low-radiation, 111

M

- Main menu, 116
- Maintenance , 137
- Making a call, 124
- Maximum recording time , 129
- Menu structure, 116
- Messages, 122, 131
- Muting, 126
- Muting button, 126

N

- Notation, 113

O

- Operating elements, 112
- Operating via the base station, 129
- Operation, 113

P

- Package contents, 109
- Paging, 126
- Phone book, 116, 120, 124
- Phone book entries, 115, 120
- PIN code, 132
- Playing, 130
- Playing back, 131
- Private branch exchanges, 128
- Problems, 133
- Problems and solutions, 134
- Pulse dialling mode, 119, 127

Q

- Quick dial, 122, 124

R

- R-button, 128
- Receiver volume, 125
- Recording, 130
- Recording a memo, 131
- Recording an outgoing message, 130
- Redialling, 117, 124
- Registering, 127
- Registration, 119
- Remote access, 132
- Remote activation, 132
- Replace receiver, 124
- Ringling melody, 117, 119
- Ringling volume, 125

Index

S

- Safety information, 108
- Saving, 115, 120
- Searching for the handset, 126
- Selecting the answering mode, 130
- Service-Hotline, 133
- Standby mode, 114
- Starting up, 109
- Storing, 123
- Supplementary services, 128
- Switching off, 129
- Switching on, 129

T

- Taking a call, 111, 124
- Taking a call being recorded, 130
- Talk time, 126
- Technical data, 135
- Telephoning, 124
- Time, 111
- Toll saver, 129
- Tone dialling mode, 119, 127
- Troubleshooting, 133

V

- VMWI, 129
- Volume, 129

Notes

Notes

Notes

Notes

SWITEL

Declaration of Conformity



Diese Anlage entspricht der europäischen R&TTE Richtlinie.
Für die komplette Konformitätserklärung nutzen Sie bitte den kostenlosen
Download von unserer Website www.switel.com.

Cet équipement est conforme à la directive européenne R&TTE.
Pour obtenir la déclaration de conformité intégrale, veuillez vous servir du
téléchargement gratuit de notre site Internet www.switel.com.

Quest'apparecchiatura è conforme alla direttiva europea R&TTE.
Per la dichiarazione di conformità completa si prega di voler usufruire del
servizio gratuito di download dal nostro sito
Internet www.switel.com.

This equipment complies with the European R&TTE directive.
To view the complete Declaration of Conformity, please refer to the free down-
load available at our web site: www.switel.com.

Service Hotline

Bei technischen Problemen können Sie sich an unsere Service-Hotline unter
Tel. 0900 00 1675 innerhalb der Schweiz (Kosten Swisscom bei Drucklegung:
CHF 2.60/min) wenden.

S'il s'agit de problèmes techniques, vous pouvez vous adresser à notre hot-
line de service en Suisse en appelant le numéro 0900 00 1675 (frais Swis-
scom à la date d'impression de ce manuel : CHF 2.60/min).

In caso di problemi tecnici è possibile rivolgersi alla nostra hotline di assi-
stenza tecnica chiamando al numero 0900 00 1675 valido per la Svizzera
(spese da rete Swisscom alla data di stampa: CHF 2.60 / min).

In the event of technical problems, you can contact our hotline service, Tel.
0900 00 1675 within Switzerland (cost via Swisscom at time of going to print:
CHF 2.60/min).