

SWITEL

SWISS BRAND 

Schnurloses DECT-/GAP-Verstärker-Telefon mit XL-Tasten

Téléphone DECT/GAP sans fil, amplifié, avec touches XL

Telefono cordless con amplificatore DECT/GAP, tasti XL

Cordless DECT/GAP amplifier telephone with XL buttons



DC68x

Bedienungsanleitung
Mode d'emploi
Istruzioni per l'uso
Operating Instructions

SWITEL

Bedienungsanleitung	3
Mode d'emploi	31
Istruzioni per l'uso	59
Operating Instructions	87
Declaration of Conformity	116

Inhaltsverzeichnis

1	Sicherheitshinweise	4
2	Telefon in Betrieb nehmen	5
3	Bedienelemente	9
4	Einführende Informationen	10
5	Menüstruktur	13
6	Telefonbuch	16
7	Anrufliste	17
8	Telefonieren	18
9	Erweitern des Telefonsystems	22
10	Besondere Funktionen	23
11	Nebenstellenanlagen / Zusatzdienste	23
12	Falls es Probleme gibt	24
13	Technische Eigenschaften	26
14	Pflegehinweise / Garantie	27
15	Stichwortverzeichnis	28

Sicherheitshinweise

1 Sicherheitshinweise

Lesen Sie diese Bedienungsanleitung sorgfältig durch.

Bestimmungsgemäße Verwendung

Dieses Telefon ist geeignet zum Telefonieren innerhalb eines Telefonnetzes. Jede andere Verwendung gilt als nicht bestimmungsgemäß. Eigenmächtige Veränderungen oder Umbauten sind nicht zulässig. Öffnen Sie das Gerät in keinem Fall selbst und führen Sie keine eigenen Reparaturversuche durch.

Aufstellungsort

Vermeiden Sie Belastungen durch Rauch, Staub, Erschütterungen, Chemikalien, Feuchtigkeit, Hitze oder direkte Sonneneinstrahlung.

Verwenden Sie das Telefon nicht in explosionsgefährdeten Bereichen.

Netzteil



Achtung: Verwenden Sie nur das mitgelieferte Steckernetzteil, da andere Netzteile das Telefon beschädigen können. Sie dürfen den Zugang zum Steckernetzteil nicht durch Möbel oder andere Gegenstände versperrern.

Aufladbare Akkus



Achtung: Werfen Sie Akkus nicht ins Feuer. Verwenden Sie nur Akkus des gleichen Typs! Achten Sie auf die richtige Polung! Bei verkehrter Polung der Akkus besteht beim Aufladen Explosionsgefahr.

Stromausfall

Bei Stromausfall kann mit diesem Telefon nicht telefoniert werden. Halten Sie für Notfälle ein schnurgebundenes Telefon bereit, welches ohne externe Stromversorgung arbeitet.

Medizinische Geräte



Achtung: Benutzen Sie das Telefon nicht in der Nähe von medizinischen Geräten. Eine Beeinflussung kann nicht völlig ausgeschlossen werden.

Hörgeräte-kompatibel

Das Telefon ist mit den meisten am Markt befindlichen Hörgeräten kompatibel. Eine einwandfreie Funktion mit jedem Hörgerät kann jedoch nicht garantiert werden.

DECT¹-Telefone können in Hörgeräten einen unangenehmen Brummtönen verursachen.

¹ **DECT:** Digital Enhanced Cordless Telecommunication = Standard für kabellose Telefone.

Telefon in Betrieb nehmen

Entsorgung

Wollen Sie Ihr Gerät entsorgen, bringen Sie es zur Sammelstelle Ihres kommunalen Entsorgungsträgers (z. B. Wertstoffhof). Nach dem Elektro- und Elektronikgerätegesetz sind Besitzer von Altgeräten gesetzlich verpflichtet, alte **Elektro- und Elektronikgeräte** einer getrennten Abfallerfassung zuzuführen. Das nebenstehende Symbol bedeutet, dass Sie das Gerät auf keinen Fall in den Hausmüll werfen dürfen!



Gefährdung von Gesundheit und Umwelt durch Akkus und Batterien!

Akkus und Batterien nie öffnen, beschädigen, verschlucken oder in die Umwelt gelangen lassen. Sie können giftige und umweltschädliche Schwermetalle enthalten. Sie sind gesetzlich verpflichtet, Akkus und Batterien beim batterievertreibenden Handel sowie bei zuständigen Sammelstellen, die entsprechende Behälter bereitstellen, sicher zu entsorgen. Die Entsorgung ist unentgeltlich. Die Symbole bedeuten, dass Sie Akkus und Batterien auf keinen Fall in den Hausmüll werfen dürfen und sie über Sammelstellen der Entsorgung zugeführt werden müssen.

Verpackungsmaterialien entsorgen Sie entsprechend den lokalen Vorschriften.

2 Telefon in Betrieb nehmen

Sicherheitshinweise



Achtung: Lesen Sie vor der Inbetriebnahme unbedingt die Sicherheitshinweise in Kapitel 1.

Verpackungsinhalt prüfen

Zum Lieferumfang gehören:

Inhalt	DC68x-Modell ¹			
	681	682	683	684
Basisstation mit Netzteil	1	1	1	1
Ladestation mit Netzteil	-	1	2	3
Mobilteil	1	2	3	4
Telefonanschlusskabel	1	1	1	1
Akkus	2	4	6	8
Bedienungsanleitung	1	1	1	1

¹ Unter www.switel.com erfahren Sie, ob dieses Telefon/Telefonset bereits erhältlich ist.

Telefon in Betrieb nehmen

Basisstation anschließen



Achtung: Stellen Sie die Basisstation mit einem Mindestabstand von 1 m zu anderen elektronischen Geräten auf, da es sonst zu gegenseitigen Störungen kommen kann.

Schließen Sie die Basisstation wie auf der Skizze abgebildet an. Verwenden Sie aus Sicherheitsgründen nur das mitgelieferte Netzteil sowie das beigelegte Telefonanschlusskabel.

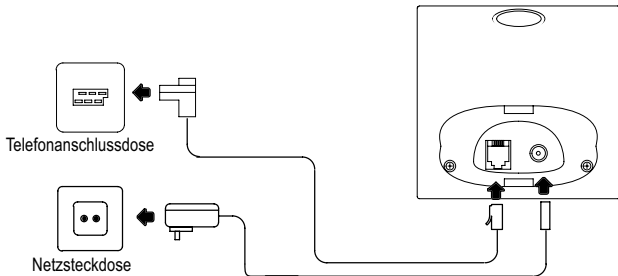

Verwenden Sie für die Basisstation das Netzteil mit Nr. SSA-5W-09 EU 075030F und den Ausgangsdaten 7,5 V, 300 mA.

Akkus einlegen

Legen Sie die Akkus in das geöffnete Akkufach ein. Verwenden Sie nur Akkus des Typs AAA NiMH 1,2 V. Achten Sie auf die richtige Polung! Schließen Sie das Akkufach.

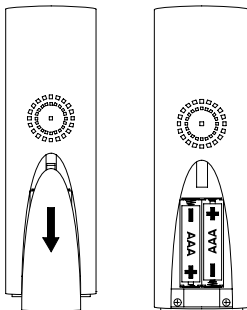

Telefon in Betrieb nehmen

Wandmontage

Ihr Telefon ist zur Wandmontage geeignet. Für die Befestigung des Telefons benötigen Sie zwei Schrauben.



Warnung: Im Bereich der zu bohrenden Löcher dürfen sich keine Leitungen (Kabel, Rohre usw.) befinden.

Bohren Sie zwei Löcher im Abstand von 55 mm waagrecht nebeneinander und lassen Sie die Schrauben 5 mm aus der Wand herausstehen. Lösen Sie die Tischhalterung der Basisstation und drehen Sie sie um 180°. Stecken Sie die Halterung anschließend wieder in die dafür vorgesehene Position, bis sie hörbar einrastet. Stecken Sie nun die Aufhängungen der Basisstation auf die Schrauben und schieben Sie sie etwas nach unten.

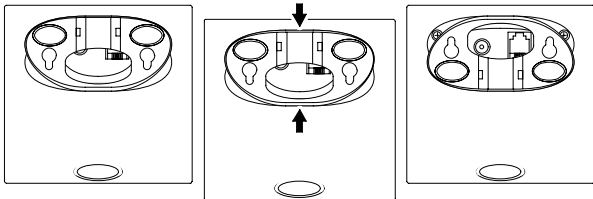

Telefon in Betrieb nehmen

Akkus aufladen



Stellen Sie das Mobilteil bei der ersten Inbetriebnahme für **mindestens 16 Stunden** in die Basisstation / Ladestation.

Haben Sie das Mobilteil richtig in die Basisstation / Ladestation gestellt, ertönt ein Hinweissignal. Das Mobilteil erwärmt sich beim Laden. Dies ist normal und ungefährlich. Laden Sie das Mobilteil nicht mit fremden Aufladegeräten. Der aktuelle **Akkuladezustand** wird im Display angezeigt:



Voll



Halb



Schwach



Leer

Displaysprache einstellen

Wählen Sie die entsprechende Sprache aus (siehe auch "Menüstruktur"):

 > EINSTELL.MT > SPRACHE >...

Es stehen 13 Sprachen zur Auswahl.

Datum und Uhrzeit des Mobilteils einstellen

Datum und Uhrzeit stellen Sie über das Menü ein. Auf Seite 13 finden Sie die Position im Menü.

Automatische Anrufannahme

Haben Sie diese Funktion aktiviert, wird ein Anruf automatisch beim Herausnehmen des Mobilteils aus der Basisstation angenommen. Die automatische Anrufannahme wird über das Menü aktiviert oder deaktiviert. Auf Seite 14 finden Sie die Position im Menü.

Nebenstellenanlagen

Auf Seite 23 erhalten Sie weitere Informationen, falls Sie Ihr Telefon an eine Nebenstellenanlage anschließen möchten.

Strahlungsreduzierung (ECO-Mode)

Die Strahlung wird im Vergleich zu Standard-DECT-Schnurlostelefonen im Bereitschaftsmodus erheblich verringert, wenn das Mobilteil in der Basis steht.

Im Gesprächsmodus wird die Strahlung abhängig von der Entfernung des Mobilteils zur Basis verringert.



3 Bedienelemente

Die Tasten Ihres Telefons werden in dieser Bedienungsanleitung nachfolgend mit vereinheitlichten umrandeten Symbolen dargestellt. Leichte Abweichungen der Tastensymbole Ihres Telefons gegenüber den hier verwendeten Tastensymbolen sind daher möglich.

Mobilteil

- 1 Hörer
- 2 LC-Display
- 3 Pfeiltaste oben / Telefonbuch
- 4 Löschen / Wahlwiederholung
- 5 Auflegetaste
- 6 Pfeiltaste unten / Anrufliste
- 7 Zifferntastenblock
- 8 #-Taste / Rufton aus
- 9 Mikrofon
- 10 *-Taste / Tastensperre
- 11 Gesprächstaste / Freisprechen
- 12 Menü-/OK-Taste
- 13 LED

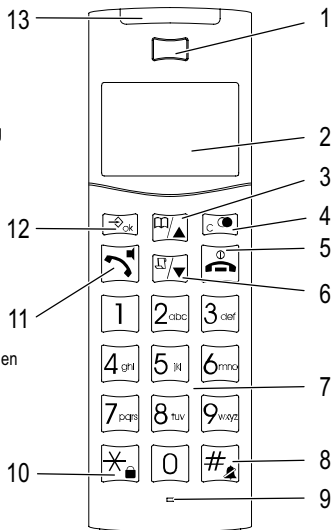

Einführende Informationen

Basisstation



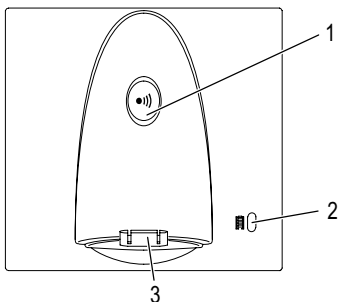





- 1 Paging-Taste
- 2 Lade-LED
- 3 Ladkontakte



4 Einführende Informationen

























In diesem Kapitel finden Sie grundlegende Informationen zur Handhabung der Bedienungsanleitung und des Telefons.

Darstellungsweise in der Bedienungsanleitung

Darstellung	Beschreibung
	Darstellung von Tasten
	Abgebildete Taste kurz drücken
2 Sek. 	Abgebildete Taste 2 Sekunden drücken
	Nummern oder Buchstaben eingeben
	Mobilteil klingelt
	Mobilteil aus der Basisstation nehmen
	Mobilteil in die Basisstation stellen
	Darstellung von Display-Texten
	Darstellung von Display-Symbolen

Einführende Informationen

Symbole und Texte im Display des Mobilteils

Symbol	Beschreibung
	Konstant: Anzeige der Akkukapazität. Leer: Die Akkus müssen geladen werden. Durchlaufende Segmente: Die Akkus werden geladen  Seite 8.
 	Sie führen ein Gespräch  Seite 18.
	Sie befinden sich im Menü  Seite 13.
	Sie befinden sich im Telefonbuch  Seite 16.
	Sie befinden sich in der Anrufliste. Es sind neue Anrufe in der Anrufliste  Seite 17.
	Der Tonruf ist ausgeschaltet  Seite 20.
	Das Mikrofon ist stummgeschaltet  Seite 21.
	Das Freisprechen ist aktiviert  Seite 20.
	Die Tastensperre ist aktiviert  Seite 21.
	Der Wecker ist eingeschaltet  Seite 13.
	Anrufbeantworter im Telefonnetz. VMWI ¹ - Zusatzdienst Ihres Netzbetreibers  Seite 24.
	Die Verbindung zur Basisstation ist gut.

Bereitschaftsmodus













Alle Beschreibungen in dieser Bedienungsanleitung gehen davon aus, dass sich das Mobilteil im Bereitschaftsmodus befindet. Das Mobilteil ist im Bereitschaftsmodus, wenn kein Gespräch geführt wird und kein Menü geöffnet ist. Drücken Sie ggf. die Taste  mehrfach, um in den Bereitschaftsmodus zu gelangen.

¹ **VMWI: Visual Message Waiting Indication** = Optische Anzeige neuer Nachrichten.

Einführende Informationen

Navigation im Menü

Alle Funktionen sind über unterschiedliche Menüs zu erreichen. Den Weg zur gewünschten Funktion entnehmen Sie der Menüstruktur  Seite 13.











	Hauptmenü öffnen
 / 	Gewünschtes Untermenü auswählen
	Untermenü öffnen
 / 	Gewünschte Funktion auswählen
	Funktion öffnen
 / 	Gewünschte Einstellung auswählen
	Über Tastenfeld Nummern oder Buchstaben eingeben
	Eingaben bestätigen
	Eine Ebene zurück
	Programmier- und Speichervorgänge abbrechen und in den Stand-by-Modus zurückkehren



Jeder Vorgang wird automatisch abgebrochen, wenn innerhalb von 20 Sekunden keine Eingabe erfolgt.





Telefonbucheinträge erstellen - Beispiel

Wie Sie in den Menüs navigieren und Einstellungen vornehmen, ist hier anhand des Beispiels **Telefonbucheinträge erstellen** erklärt. Verfahren Sie bei allen Einstellungen wie in diesem Beispiel.





	Hauptmenü öffnen
 /  TELEFONBUCH 	Telefonbuch öffnen
 NEU 	Untermenü auswählen und bestätigen
 	Namen eingeben (max. 12 Stellen) und bestätigen
 	Rufnummer eingeben (max. 20 Ziffern) und bestätigen

5 Menüstruktur



Hauptmenü

In das Hauptmenü gelangen Sie, wenn Sie die Taste  drücken. Danach wählen Sie mit den Tasten  /  einen Eintrag aus und bestätigen Sie Ihre Auswahl mit der Taste . Weitere Informationen zum Menü und zur Bedienung  Kapitel 4.

TELEFONBUCH

NEU	NAME EING.  ¹	NUMMER 
ÄNDERN	NAME EING. 	NUMMER 
LÖSCHEN		
ALLES LOSCH	BESTÄTIGEN?	
KLINGELTON VIP	AUS, 1 - 12	
KURZWahl	NEU	KURZWahl TASTE 1 - 9
	LÖSCHEN	KURZWahl TASTE 1 - 9
SPEICHER STATUS		



UHR/WECKER

DATUM & ZEIT		
WECKER EINST	EINMALIG	EIN 
		AUS
	TÄGLICH	EIN 
		AUS

¹ Die Zifferntasten sind mit Buchstaben beschriftet. Durch mehrmaliges Drücken der entsprechenden Taste können Buchstaben, Ziffern und Sonderzeichen eingegeben werden.







Menüstruktur

MT EINSTELL.

MOBIL. TÖNE	RUFTONLAUTST	LAUTST.
	RUFTONMELOD.	MELODIE 1-12
	INTERKOM	MELODIE 1-12
	TASTENTON	EIN / AUS
	AKKU WARNTON	EIN / AUS
	REICHWEITE	EIN / AUS
VERSTÄRKER	EIN / AUTO / AUS	
KONTRAST	01 - 06	
MOBIL. NAME		
AUTO ANNAHME	EIN / AUS	
SPRACHE		
BABYRUF	NUM. EING.	
	BABYRUF EIN/AUS	EIN / AUS

Menüstruktur

BS EINSTELL.

VMWI AUS ¹	BESTÄTIGEN?		
ANMELDEN	BASIS 1 - 4	PIN? ²	
BASIS WÄHLEN	BASIS 1 - 4 / AUTO		
ERW. EINST.			
PIN? 	WAHLVERFAHR.	TONWAHL / IMPULSWAHL	
	FLASH-DAUER	100 MS / 300 MS / 600 MS	
	ORTSVORWAHL		
	VORWAHL		
	ANRUFSPERRE	OPTION 1 - 4	NUM. EING. 
	SOS NUMMER	OPTION 1 - 4	NUM. EING. 
	ABMELDEN	MOBILTEIL X	
	PIN ÄNDERN	PIN? 	
	RESET	BESTÄTIGEN?	

¹ **VMWI: Visual Message Waiting Indication** = Optische Anzeige neuer Nachrichten.

² Der PIN-Code ist werkseitig auf "0000" eingestellt.

Telefonbuch

6 Telefonbuch

Im Telefonbuch können Sie 60 Rufnummern mit den dazugehörigen Namen speichern.

- Geben Sie bei allen Rufnummern immer die Vorwahl mit ein, damit auch eingehende Ortsgespräche einem Telefonbucheintrag zugeordnet werden können.
- Ist die Speicherkapazität erschöpft, zeigt das Display beim nächsten Speichern die Meldung **SPEICH. VOLL**. Um wieder Platz zu schaffen, müssen Sie zuerst einen anderen Eintrag löschen.
- Die Telefonbucheinträge sind alphabetisch geordnet.

Namen eingeben

Die Zifferntasten sind mit Buchstaben beschriftet. Durch mehrmaliges Drücken der entsprechenden Taste können Buchstaben, Ziffern und Sonderzeichen eingegeben werden.

	Leerzeichen eingeben
	Sonderzeichen eingeben
	Löschen
/	Cursor bewegen



Um den gleichen Buchstaben zweimal einzugeben, drücken Sie die entsprechende Taste. Warten Sie, bis der Cursor eine Stelle weitersprungen ist. Geben Sie den Buchstaben erneut ein.

Telefonbucheinträge erstellen

	Telefonbuch öffnen
NEU	Untermenü auswählen und bestätigen
	Namen eingeben (max. 12 Stellen) und bestätigen
	Rufnummer eingeben (max. 20 Ziffern) und bestätigen

Telefonbucheinträge ändern







	Telefonbuch öffnen
/	Eintrag auswählen, bestätigen
/ ÄNDERN	Untermenü auswählen und bestätigen
	Namen ändern und bestätigen
	Rufnummer ändern und bestätigen

Telefonbucheinträge löschen

Einen Eintrag löschen

	Telefonbuch öffnen
 /  , 	Eintrag auswählen, bestätigen
 /  , LÖSCHEN 	Untermenü auswählen und bestätigen

Alle Einträge löschen

	Telefonbuch öffnen
 ,  /  ,	
ALLES LOSCH 	Untermenü auswählen und bestätigen
BESTÄTIGEN?  oder 	Löschvorgang bestätigen oder abbrechen

7 Anrufliste

Insgesamt werden 50 Rufnummern in einer Anrufliste gespeichert.













Die Rufnummernanzeige (CLIP¹) ist ein Zusatzdienst Ihres Netzbetreibers. Ihr Telefon zeigt die Rufnummern im Display, wenn Ihr Netzbetreiber diesen Service anbietet. Bitte fragen Sie Ihren Netzbetreiber nach weiteren Informationen.

Rufnummern aus der Anrufliste anzeigen

 ,  / 	Anrufliste öffnen und Eintrag auswählen
-----------------------------------------------------------------------------------------------------------------------------------------------------------------------------------------------------------------------------------------------------------	-----------------------------------------

Rufnummer aus der Anrufliste im Telefonbuch speichern

Eine Rufnummer kann direkt aus der Anrufliste im Telefonbuch gespeichert werden.

 ,  / 	Anrufliste öffnen und Eintrag auswählen
	Menü öffnen
 / 	
NUM. SPEICH 	Untermenü auswählen und bestätigen
 , 	Namen eingeben (max. 12 Stellen) und bestätigen
 , 	Rufnummer ändern und bestätigen

¹ CLIP: Calling Line Identification Presentation = Anzeige der Rufnummer eines Anrufers.

Telefonieren

Rufnummern aus der Anrufliste löschen

Einzelne Rufnummer löschen

	Anrufliste öffnen und Eintrag auswählen
	Menü öffnen
	Untermenü auswählen und bestätigen

Alle Rufnummern löschen

	Anrufliste öffnen
	Menü öffnen
	Untermenü auswählen und bestätigen
	Löschvorgang bestätigen oder abbrechen

8 Telefonieren

Anruf annehmen

	Anruf annehmen
--	----------------

Gespräch beenden

	Gespräch beenden
--	------------------

Anrufen

	Rufnummer eingeben (max. 32 Ziffern)
	Bei Falscheingabe letzte Ziffer löschen
	Rufnummer wählen



Sie können auch zuerst die Taste drücken und erhalten damit das Freizeichen. Die eingegebenen Ziffern Ihrer gewünschten Rufnummer werden sofort gewählt. Eine Korrektur einzelner Ziffern der Rufnummer ist bei dieser Form des Gesprächsaufbaus nicht möglich.

Wahlwiederholung

Ihr Telefon speichert die 20 zuletzt gewählten Rufnummern in einer Wahlwiederholungsliste.

	Wahlwiederholungsliste öffnen und Eintrag auswählen
	Verbindung herstellen

Das Bearbeiten von Rufnummern in einer Wahlwiederholungsliste ist identisch zur Bearbeitung von Rufnummern in der Anrufliste Kapitel 7.

Telefonieren

Eingegangene Anrufe zurückrufen

Ihr Telefon speichert 50 Rufnummern in einer Anrufliste.

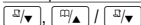

Anrufliste öffnen und Eintrag auswählen



Verbindung herstellen

Rufnummern aus dem Telefonbuch wählen

Sie müssen Rufnummern im Telefonbuch gespeichert haben Seite 16.



Telefonbuch öffnen und Eintrag auswählen



Verbindung herstellen

Intern telefonieren¹

Interne Gespräche führen

Sie müssen zwei oder mehr Mobilteile (MT1, MT2, ...) an Ihrer Basisstation angemeldet haben, um interne kostenlose Gespräche führen zu können.



Internes Telefonieren einleiten

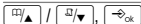

Interne Rufnummer des gewünschten Mobilteils wählen



Internes Gespräch am anderen Mobilteil annehmen



Internes Gespräch beenden

Externe Gespräche intern weiterleiten

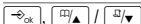

Während des externen Gesprächs

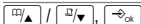

Interne Rufnummer wählen



Internes Gespräch am anderen Mobilteil annehmen



Gespräch weiterleiten

¹ Das interne Telefonieren ist nur mit mindestens zwei Mobilteilen möglich "Verpackungsinhalt prüfen" auf Seite 5.

Telefonieren

Rücksprache / Makeln



INTERKOM

Während des externen Gesprächs



Interne Rufnummer wählen



Internes Gespräch am anderen Mobilteil annehmen



MAKELN

Gesprächspartner wechseln

Konferenzgespräche führen

Ein externes Gespräch kann mit einem weiteren internen Gesprächspartner zum Konferenzgespräch geschaltet werden.



INTERKOM

Während des externen Gesprächs



Interne Rufnummer wählen



Internes Gespräch am anderen Mobilteil annehmen



KONFERENZ

Konferenz starten



Konferenz beenden

Einstellen der Hörerlautstärke

Sie können während eines Gesprächs die Lautstärke in 5 Stufen anpassen.



Gewünschte Lautstärke auswählen

Anzeige der Gesprächsdauer

Während eines Gesprächs wird die Gesprächsdauer in Stunden, Minuten und Sekunden angezeigt.

Rufton ausschalten

Sie können den Rufton des Mobilteils ausschalten



Rufton ausschalten



Rufton einschalten

Freisprechen

Nutzen Sie diese Funktion, um den Gesprächspartner über den Lautsprecher zu hören.



Freisprechen einschalten



Freisprechen ausschalten

Telefonieren

Mikrofon im Mobilteil stummschalten

Sie können während eines Telefongesprächs das Mikrofon des Mobilteils aus- und einschalten.

 STUMM EIN  Mikrofon ausschalten (stummschalten)

 STUMM AUS  Mikrofon einschalten

Tastensperre

Die Tastensperre soll verhindern, dass versehentlich Funktionen ausgelöst werden.

3 Sek.  Tastensperre einschalten



Bei eingeschalteter Tastensperre können eingehende Anrufe wie gewohnt angenommen werden.

3 Sek.  Tastensperre ausschalten

Mobilteil suchen (Paging)

Wenn Sie Ihr Mobilteil verlegt haben, können Sie es über einen Suchton leicht wiederfinden.

An der Basis   Suchton starten

 oder  Suchton beenden

Erweitern des Telefonsystems

9 Erweitern des Telefonsystems

Über den international genormten **GAP**¹-Standard ist die Kompatibilität von Mobilteilen und Basisstationen unterschiedlicher Hersteller geregelt. So ist es möglich, SWITEL-Geräte und Geräte anderer Hersteller zusammen in ein Telefonsystem zu integrieren. Es ist jedoch möglich, dass einige Funktionen nicht zur Verfügung stehen.

Mehrere Mobilteile



Sie können insgesamt 6 Mobilteile an Ihre Basisstation anmelden.

Anmelden von Mobilteilen

Bevor Sie ein Mobilteil anmelden, müssen Sie die Basisstation in den Registriermodus setzen.

10 Sek. 

Registriermodus starten

Melden Sie nun das Mobilteil an  Kapitel 5. Benutzen Sie zur Anmeldung den aktuell eingestellten PIN-Code  Kapitel 5.

Nach dem Anmelden wird dem Mobilteil eine interne Rufnummer zugeteilt. Diese interne Rufnummer wird im Display angezeigt.



Um Mobilteile anderer Hersteller anzumelden, lesen Sie bitte deren Bedienungsanleitungen.

Abmelden von Mobilteilen



Sie können ein Mobilteil von einer Basisstation nur durch ein weiteres an dieser Basisstation angemeldetes Mobilteil abmelden.

Mobilteile werden über das Menü abgemeldet. Im Kapitel 5 finden Sie die Position im Menü.

Mehrere Basisstationen

Sie können die Reichweite Ihres Mobilteils vergrößern, wenn Sie es an mehrere Basisstationen anmelden. Es kann gleichzeitig an 4 verschiedenen Basisstationen angemeldet sein. Jede Basisstation benötigt eine eigene Telefonsteckdose. Es können Anschlüsse mit derselben und auch mit unterschiedlichen Rufnummern sein.



Laufende Gespräche können nicht von einer zur anderen Basisstation übertragen werden.

¹ **GAP: Generic Access Profile** = Standard für das Zusammenwirken von Mobilteilen und Basisstationen unterschiedlicher Hersteller.

10 Besondere Funktionen



Wahlverfahren

Sie können Ihr Telefon sowohl an den analogen Vermittlungsstellen (Impuls-Wahlverfahren) als auch an den neuen digitalen Vermittlungsstellen (Ton-Wahlverfahren) betreiben. Das Wahlverfahren wird über das Menü eingestellt. Auf Seite 15 finden Sie die Position im Menü.

Wecker

Mit dieser Funktion können Sie sich zu einer bestimmten Zeit von Ihrem Mobilteil wecken lassen.

Babyruf

Mit dieser Funktion haben Sie die Möglichkeit, eine bestimmte Rufnummer zu speichern, die bei Betätigen einer beliebigen Taste (außer  und ) automatisch angerufen wird.

Anrufsperr

Die Rufnummernsperr hindert Mobilteile daran, von Ihnen hinterlegte Rufnummern zu wählen. Sie können 4 Sperrnummern, die aus jeweils 8 Ziffern bestehen können, hinterlegen. Auf Seite 15 finden Sie die Position im Menü.

SOS Nummer

Sie können bis zu 4 Rufnummern hinterlegen, die trotz aktivierter Rufnummernsperr gewählt werden können. Auf Seite 15 finden Sie die Position im Menü.

11 Nebenstellenanlagen / Zusatzdienste

R-Taste und Zusatzdienste

Ihr Telefon unterstützt Zusatzdienste Ihres Netzbetreibers, wie z. B. Makeln, Anklopfen und Konferenz. Über die Taste  können Sie diese Zusatzdienste nutzen. Bitte fragen Sie Ihren Netzbetreiber, welche Flash-Zeit Sie zur Nutzung von Zusatzdiensten einstellen müssen. Zur Freischaltung von Zusatzdiensten wenden Sie sich bitte an Ihren Netzbetreiber. Die Flash-Zeit stellen Sie über das Menü ein. Auf Seite 15 finden Sie die Position im Menü.

R-Taste an Nebenstellenanlagen

Ist Ihr Telefon an einer Nebenstellenanlage angeschlossen, können Sie über die Taste  Funktionen, wie z. B. Anrufe weiterleiten und automatischen Rückruf, nutzen. Lesen Sie bitte in der Bedienungsanleitung Ihrer Nebenstellenanlage, welche Flash-Zeit Sie zur Nutzung dieser Funktionen einstellen müssen. Ob Ihr Telefon an Ihrer Nebenstellenanlage einwandfrei funktioniert, erfahren Sie bei dem Händler, bei dem die Anlage gekauft wurde. Die Flash-Zeit stellen Sie über das Menü ein. Auf Seite 15 finden Sie die Position im Menü.

Falls es Probleme gibt

Wahlpause

Bei Nebenstellenanlagen ist es erforderlich, eine Amtskennzahl vorzuwählen, um ein Freizeichen zu bekommen. Bei wenigen älteren Nebenstellenanlagen dauert es einige Zeit, bis das Freizeichen zu hören ist. Für diese Nebenstellenanlagen kann nach der Amtskennzahl eine Wahlpause eingefügt werden, um direkt weiterwählen zu können, ohne das Freizeichen abzuwarten. Die Wahlpause fügen Sie durch Drücken und 3 Sek. halten der Taste  ein.

Nach der Amtskennzahl erfolgt die Wahl der eigentlichen Rufnummer nach einer bestimmten Zeit.



Die Wahlpause kann auch bei der Eingabe von Rufnummern im Telefonbuch gespeichert werden.

Rufnummernanzeige (CLIP¹)



Die Rufnummernanzeige ist ein Zusatzdienst Ihres Netzbetreibers. Fragen Sie Ihren Netzbetreiber nach weiteren Informationen.

Wenn diese Funktion an Ihrer Telefonleitung zur Verfügung steht, wird Ihnen bereits die Rufnummer des Anrufers angezeigt, wenn das Telefon klingelt. Hat der Anrufer das Übertragen seiner Rufnummer unterdrückt, wird eine entsprechende Meldung angezeigt. Die Rufnummer kann nicht angezeigt und somit auch nicht in der Anrufliste gespeichert werden.

Anrufbeantworter im Telefonnetz

Der Anrufbeantworter im Telefonnetz ist ein Zusatzdienst vieler Netzbetreiber. Wenn Ihr Netzbetreiber einen Anrufbeantworter im Telefonnetz für Sie bereitstellt, werden Sie mit einem Symbol über neue Nachrichten informiert (**VMWI**²). Über diese Funktion können Sie nur dann verfügen, wenn Ihr Netzbetreiber diesen Zusatzdienst anbietet. Bitte fragen Sie Ihren Netzbetreiber nach weiteren Informationen.

12 Falls es Probleme gibt

Service-Hotline

Haben Sie Probleme mit Ihrem Telefon, kontrollieren Sie zuerst die folgenden Hinweise. Bei technischen Problemen können Sie sich an unsere Service-Hotline unter Tel. 0900 00 1675 innerhalb der Schweiz (Kosten Swisscom bei Drucklegung: CHF 2.60/min) wenden. Bei Garantiesprüchen wenden Sie sich an Ihren Fachhändler. Die Garantiezeit beträgt 2 Jahre.

¹ **CLIP**: Calling Line Identification Presentation = Anzeige der Rufnummer eines Anrufers.

² **VMWI**: Visual Message Waiting Indication = Optische Anzeige neuer Nachrichten.

Falls es Probleme gibt

Fragen und Antworten

Fragen	Antworten
Kein Telefongespräch möglich	<ul style="list-style-type: none">- Das Telefon ist nicht korrekt angeschlossen oder gestört. Verwenden Sie nur das mitgelieferte Telefonanschlusskabel.- Testen Sie mit einem anderen Telefon, ob Ihr Telefonanschluss in Ordnung ist.- Das Netzteil ist nicht eingesteckt oder es liegt ein totaler Stromausfall vor.- Die aufladbaren Akkus sind leer oder defekt.- Sie haben sich zu weit von der Basisstation entfernt.- Wahlverfahren falsch eingestellt ☞ Seite 15.
Keine Verbindung zur Basisstation möglich	<ul style="list-style-type: none">- Prüfen Sie, ob Sie sich mit dem richtigen PIN-Code an der Basisstation angemeldet haben ☞ Seite 15.
Verbindung abgehackt, fällt aus	<ul style="list-style-type: none">- Sie haben sich zu weit von der Basisstation entfernt.- Falscher Aufstellungsort der Basisstation.
Das System reagiert nicht mehr	<ul style="list-style-type: none">- Setzen Sie alle Funktionen in den Werkszustand zurück ☞ Seite 15.- Ziehen Sie kurzzeitig das Netzteil aus der Steckdose.
Die Akkus sind in kürzester Zeit leer	<ul style="list-style-type: none">- Die Akkus sind leer oder defekt.- Stellen Sie das Mobilteil richtig auf die Basisstation. Reinigen Sie die Kontaktflächen am Mobilteil und an der Basisstation mit einem weichen trockenen Tuch.- Stellen Sie das Mobilteil für 16 Stunden in die Basisstation.
Die Rufnummernanzeige (CLIP) funktioniert nicht	<ul style="list-style-type: none">- Die Rufnummernanzeige ist ein Zusatzdienst Ihres Netzbetreibers. Bitte fragen Sie Ihren Netzbetreiber nach weiteren Informationen.- Der Anrufer hat das Übertragen seiner Rufnummer unterdrückt.

Technische Eigenschaften

13 Technische Eigenschaften

Technische Daten

Merkmal	Wert
Standard	DECT ¹ -GAP ²
Stromversorgung (Basisstation)	Eingang: 230 V, 50 Hz Ausgang: 7,5 V, 300 mA
Stromversorgung (Ladestation)	Eingang: 230 V, 50 Hz Ausgang: 7,5 V, 100 mA
Reichweite	Außen: ca. 300 m Innen: ca. 50 m
Stand-by-Zeit	Bis zu 100 h
Max. Gesprächsdauer	Bis zu 10 h
Aufladbare Akkus	2 x AAA NiMH 1,2 V
Wahlverfahren	Ton-Wahlverfahren Impuls-Wahlverfahren
Flash-Funktion	100 ms, 300 ms, 600 ms

Konformitätserklärung

Dieses Gerät erfüllt die Anforderungen der EU-Richtlinie: 1999/5/EG Richtlinie über Funkanlagen und Telekommunikationsend-einrichtungen und die gegenseitige Anerkennung ihrer Konformität. Die Konformität mit der o. a. Richtlinie wird durch das CE-Zeichen auf dem Gerät bestätigt.



Für die komplette Konformitätserklärung nutzen Sie bitte den kostenlosen Download von unserer Website www.switel.com.

¹ **DECT**: Digital Enhanced Cordless Telecommunication = Standard für kabellose Telefone.

² **GAP**: Generic Access Profile = Standard für das Zusammenwirken von Mobilteilen und Basisstationen unterschiedlicher Hersteller.

14 Pflegehinweise / Garantie

Pflegehinweise

- Reinigen Sie die Gehäuseoberflächen mit einem weichen und fusselfreien Tuch.
- Verwenden Sie keine Reinigungs- oder Lösungsmittel.

Garantie

SWITEL - Geräte werden nach den modernsten Produktionsverfahren hergestellt und geprüft. Ausgesuchte Materialien und hoch entwickelte Technologien sorgen für einwandfreie Funktion und lange Lebensdauer. Ein Garantiefall liegt nicht vor, wenn die Ursache einer Fehlfunktion des Geräts bei dem Telefonnetzbetreiber oder einer eventuell zwischengeschalteten Nebenstellenanlage liegt. Die Garantie gilt nicht für die in den Produkten verwendeten Batterien, Akkus oder Akkupacks. Die Garantiezeit beträgt 24 Monate, gerechnet vom Tage des Kaufs.

Innerhalb der Garantiezeit werden alle Mängel, die auf Material- oder Herstellungsfehler zurückzuführen sind, kostenlos beseitigt. Der Garantieanspruch erlischt bei Eingriffen durch den Käufer oder durch Dritte. Schäden, die durch unsachgemäße Behandlung oder Bedienung, natürliche Abnutzung, durch falsches Aufstellen oder Aufbewahren, durch unsachgemäßen Anschluss oder Installation sowie durch höhere Gewalt oder sonstige äußere Einflüsse entstehen, fallen nicht unter die Garantieleistung. Wir behalten uns vor, bei Reklamationen die defekten Teile auszubessern, zu ersetzen oder das Gerät auszutauschen. Ausgetauschte Teile oder ausgetauschte Geräte gehen in unser Eigentum über. Schadenersatzansprüche sind ausgeschlossen, soweit sie nicht auf Vorsatz oder grober Fahrlässigkeit des Herstellers beruhen.

Sollte Ihr Gerät dennoch einen Defekt innerhalb der Garantiezeit aufweisen, wenden Sie sich bitte unter Vorlage Ihrer Kaufquittung ausschließlich an das Geschäft, in dem Sie Ihr SWITEL - Gerät gekauft haben. Alle Gewährleistungsansprüche nach diesen Bestimmungen sind ausschließlich gegenüber Ihrem Fachhändler geltend zu machen. Nach Ablauf von zwei Jahren nach Kauf und Übergabe unserer Produkte können Gewährleistungsrechte nicht mehr geltend gemacht werden.

Stichwortverzeichnis

15 Stichwortverzeichnis

A

Abmelden, 22
Akkuladezustand, 8
Akkus einlegen, 6
Ändern, 16
Anmelden, 22
Anrufannahme, 8, 18
Anrufbeantworter im Telefonnetz, 24
Anrufen, 18
Anrufliste, 17
Anrufsperrung, 23
Aufladen, 8
Auflegen, 18

B

Babyruf, 23
Basisstation, 6, 22
Bedienelemente, 9
Bedienung, 10

C

CLIP, 24

D

Datum, 8
Display, 11
Displaysprache, 8
Displaysymbole, 11

E

ECO-Mode, 8
Erstellen, 12
Erweiterung, 22

F

Fehlerbehebung, 24
Fragen und Antworten, 25
Freisprechen, 20
Funktionen, 23

G

Garantie, 27
Gespräch beenden, 18
Gesprächsdauer, 20
Gesprächsweiterleitung, 19

H

Hauptmenü, 13
Hörerlautstärke, 20

I

Inbetriebnahme, 5
Interngespräche, 19

K

Konferenzgespräche, 20
Konformitätserklärung, 26

L

Löschen, 17, 18

M

Makeln, 20
Menüstruktur, 13
Mikrofonstummschaltung, 21
Mobilteil, 22

N

Namenseingabe, 16
Nebenstellenanlagen, 23
Notruf, 23

Stichwortverzeichnis

P

Paging, 21
Pflegehinweise, 27
Probleme, 24

R

R-Taste, 23
Rückruf, 19
Rücksprache, 20
Rufnummernanzeige, 17, 24
Rufton, 20

S

Schreibweisen, 10
Service-Hotline, 24
Sicherheitshinweise, 4
Speichern, 12, 17
Stand-by-Modus, 11
Strahlungsreduzierung, 8
Stummschaltung, 21
Suchen, 21
Symbole, 11

T

Tastensperre, 21
Technische Daten, 26
Telefonbuch, 16, 19
Telefonbucheinträge, 12, 16
Telefonieren, 18
Texteingabe, 16

U

Uhrzeit, 8

V

Verpackungsinhalt, 5
VMWI, 24

W

Wählen, 19
Wahlpause, 24
Wahlverfahren, 23
Wahlwiederholung, 18
Wandmontage, 7
Wecker, 23
Weiterleitung, 19

Z

Zusatzdienste, 23

Notizen

Notizen

Table des matières

1	Consignes de sécurité	32
2	Mettre le téléphone en service	33
3	Éléments de manipulation	37
4	Introduction	38
5	Structure du menu	41
6	Répertoire	44
7	Liste d'appels	45
8	Téléphoner	46
9	Élargissement du système téléphonique . .	50
10	Fonctions particulières	51
11	Installations à postes supplémentaires / Services confort	51
12	En cas de problèmes	52
13	Caractéristiques techniques	54
14	Remarques d'entretien / Garantie	55
15	Index	56

Consignes de sécurité

1 Consignes de sécurité

Lisez très attentivement ce mode d'emploi.

Utilisation conforme à l'usage

Ce téléphone convient pour téléphoner à l'intérieur d'un réseau téléphonique. Toute autre utilisation est considérée comme non conforme à son usage. Des modifications ou transformations effectuées de façon arbitraire ne sont pas autorisées. N'ouvrez en aucun cas l'appareil et ne tentez pas de le réparer vous-même.

Lieu d'installation

Évitez les nuisances causées par la fumée, la poussière, les vibrations, les produits chimiques, l'humidité, la grande chaleur ou un ensoleillement direct.

Ne vous servez pas du téléphone dans des endroits exposés aux explosions.

Bloc secteur



Attention : N'utilisez que le bloc secteur fourni avec l'appareil, d'autres pouvant endommager votre téléphone. Vous ne devez pas en bloquer l'accès par des meubles ou d'autres objets.

Piles rechargeables



Attention : Ne jetez jamais les piles rechargeables dans le feu. N'utilisez que des piles rechargeables du même type ! Observez une polarisation correcte ! Risque d'explosion lors de leur chargement si la polarisation est incorrecte.

Panne de courant

En cas de panne de courant, il ne vous est pas possible de téléphoner avec cet appareil. Pour les cas d'urgence, prévoyez un téléphone avec fil fonctionnant sans alimentation externe en courant.

Appareils médicaux



Attention : N'utilisez pas ce téléphone à proximité d'appareils médicaux. Son influence sur ceux-ci ne pouvant pas être entièrement exclue.

Compatible avec les aides auditives

Ce téléphone est compatible avec la plupart des aides auditives en vente sur le marché. Cependant, un fonctionnement irréprochable ne peut être garanti pour chacune d'entre elles.

Les téléphones **DECT**¹ peuvent causer un bourdonnement désagréable dans les aides auditives.

¹ **DECT**: Digital Enhanced Cordless Telecommunication = Standard pour les téléphones sans fil.

Mettre le téléphone en service

Élimination

Si vous voulez mettre votre appareil au rebut, veuillez l'apporter au centre de collecte de l'organisme d'élimination des déchets de votre commune (par ex. centre de recyclage). D'après la loi relative aux appareils électriques et électroniques, les propriétaires d'**appareils électriques et électroniques** usagés sont tenus de les déposer dans un collecteur séparé. L'icône ci-contre signifie que vous ne devez en aucun cas jeter votre appareil dans les ordures ménagères !



Mise en danger de l'homme et de l'environnement causée par les piles et les piles rechargeables !



Ne jamais ouvrir, endommager, avaler les piles rechargeables et les piles ou ne jamais faire pénétrer leur contenu dans l'environnement. Elles peuvent contenir des métaux lourds toxiques et nuisibles pour celui-ci. Vous êtes tenus par la loi d'éliminer vos piles rechargeables et piles auprès d'un revendeur de piles ainsi qu'auprès de centres de collecte responsables de leur élimination qui mettent des conteneurs adéquats à disposition. L'élimination des piles est gratuite. L'icône ci-contre signifie que vous ne devez en aucun cas jeter les piles rechargeables et piles dans les ordures ménagères, mais que vous devez les éliminer auprès de centres de collecte.

Éliminez les **fournitures d'emballage** conformément au règlement local.

2 Mettre le téléphone en service

Remarques concernant la sécurité



Attention : Avant de mettre votre appareil en service, lisez impérativement les consignes de sécurité mentionnées au chapitre 1.

Vérifier le contenu du coffret

Les éléments suivants font partie du coffret :

Contenu	Modèle DC68x ¹			
	681	682	683	684
Base avec bloc secteur	1	1	1	1
Station d'accueil avec bloc secteur	-	1	2	3
Combiné	1	2	3	4
Câble de raccordement téléphonique	1	1	1	1

¹ À l'adresse www.switel.com, vous apprendrez si ce téléphone/kit téléphonique est déjà commercialisé.

Mettre le téléphone en service

Piles rechargeables	2	4	6	8
Mode d'emploi	1	1	1	1

Raccorder la base



Attention : Posez la base à une distance minimum d'1 m par rapport à d'autres appareils électroniques, une distance inférieure pouvant provoquer des interactions.

Raccordez la base comme représenté sur le croquis. Pour des raisons de sécurité, n'utilisez que le bloc secteur ainsi que le câble de raccordement téléphonique fournis avec l'appareil.

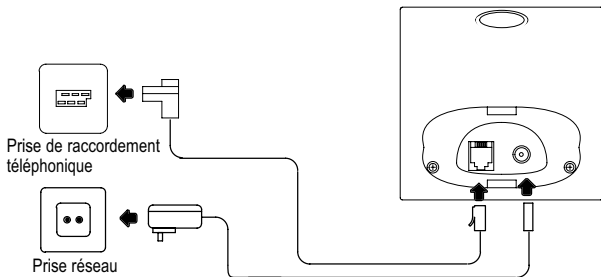

Pour la base, utilisez le bloc secteur portant le n° SSA-5W-09 EU 075030F et les données de sortie 7,5 V, 300 mA.

Insérer les piles rechargeables

Insérez les piles rechargeables dans leur compartiment ouvert y réservé. N'utilisez que des piles de type AAA NiMH 1,2 V. Observez une polarisation correcte ! Fermez le compartiment.

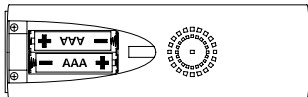
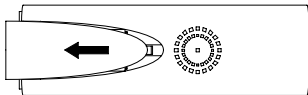

Mettre le téléphone en service

Montage mural

Votre téléphone est conçu pour le montage mural. Vous avez besoin de deux vis pour fixer le téléphone.



Avertissement : Il ne doit pas se trouver de conduites (câbles, tuyaux etc.) dans la zone de perforation des trous.

Percez deux trous l'un à côté de l'autre à une distance de 55 mm et faites dépasser les vis du mur de 5mm. Desserrez le support de table de la base et faites le pivoter de 180°. Posez ensuite le support à la position prévue à cet effet jusqu'à ce vous entendiez qu'il s'enclenche. Fixez maintenant les encoches de la base sur les vis et poussez celle-ci légèrement vers le bas.

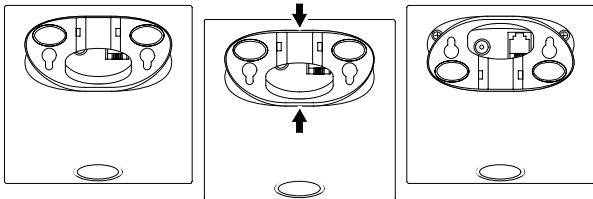

Recharger les piles rechargeables



Lors de la première mise en service, laissez le combiné pendant **au moins 16 heures** sur la base / la station d'accueil.

Si vous avez placé le combiné correctement sur la base / le chargeur, un signal indicateur se fait entendre. Le combiné chauffe lors de la charge. Ceci est normal et sans danger. Ne chargez pas le combiné avec des chargeurs d'autres fabricants. Le **niveau de chargement des piles rechargeables** est affiché à l'écran :



Plein



Moyen



Faible



Vide

Programmer la langue de l'écran

Sélectionnez la langue correspondante (voir également "structure de menu"):

 > RÉGL.MT > LANGUE>...

Vous disposez de 13 langues.

Mettre le téléphone en service

Programmer l'heure et la date du combiné

Vous programmez la date et l'heure via le menu. La page 41 vous donnera la position dans le menu.

Prise d'appel automatique

Si vous avez activé cette fonction, l'appel sera automatiquement pris lorsque vous retirerez le combiné de la base. La prise d'appel automatique s'active ou se désactive via le menu. La page 42 vous donnera la position dans le menu.

Installations PABX

La page 51 vous donnera de plus amples informations au cas où vous désireriez raccorder votre téléphone à une installation PABX.

Réduction du rayonnement (mode ÉCO)

Comparé aux téléphones sans fil DECT standard, le rayonnement est considérablement réduit en mode veille quand le combiné repose sur la base.

En mode de communication, le rayonnement est réduit en fonction de l'éloignement du combiné par rapport à la base.



Éléments de manipulation

3 Éléments de manipulation

Dans ce mode d'emploi, les touches de votre téléphone sont représentées par des icônes encadrées standardisées. Il peut donc y avoir de légères différences entre les icônes des touches de votre téléphone et celles des touches utilisées ici.

Combiné

- 1 Écouteur
- 2 Écran LCD
- 3 Touche fléchée vers le haut / Répertoire
- 4 Effacer / Touche Bis
- 5 Touche Raccrocher
- 6 Touche fléchée vers le bas / Liste d'appels
- 7 Clavier numérique
- 8 Touche # / Sonnerie désactivée
- 9 Microphone
- 10 Touche * / Verrouillage du clavier
- 11 Touche de communication / Mode mains-libres
- 12 Touche OK / de menu
- 13 DEL

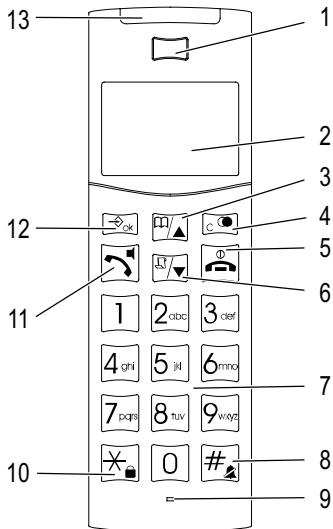

Introduction

Base



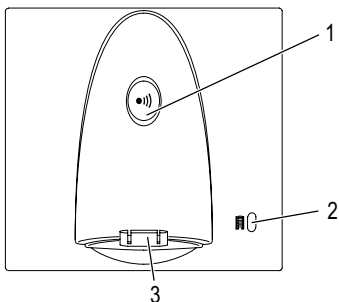





- 1 Touche de paging
- 2 DEL de chargement
- 3 Contacts de chargement















4 Introduction

Vous trouverez dans ce chapitre des informations de base vous expliquant comment vous servir du mode d'emploi et du téléphone.

Mode de représentation dans le mode d'emploi

Visualisation	Description
	Visualisation des touches
	Appuyer brièvement sur la touche représentée
2 sec. 	Appuyer 2 secondes sur la touche représentée
	Saisir des chiffres ou des lettres
	Le combiné sonne
	Retirer le combiné de la base
	Poser le combiné sur la base
REPertoire	Visualisation des textes de l'écran
	Visualisation des icônes de l'écran

Icônes et textes à l'écran du combiné

Icône	Description
	Constant : affichage de la capacité des piles rechargeables. Vide : les piles doivent être rechargées. Segments continus : les piles rechargeables se rechargent ☞ page 35.
	Vous passez une communication ☞ page 46.
	Vous vous trouvez au menu ☞ page 41.
	Vous vous trouvez dans le répertoire ☞ page 44.
	Vous vous trouvez dans la liste d'appels. Vous avez de nouveaux appels dans la liste d'appels ☞ page 45.
	La sonnerie est débranchée ☞ page 48.
	Le microphone est réglé sur silencieux ☞ page 49.
	Le mode mains-libres est activé ☞ page 48.
	Le verrouillage du clavier est activé ☞ page 49.
	Le réveil est activé ☞ page 41.
	Répondeur dans le réseau téléphonique. Service confort VMW¹ de votre opérateur ☞ page 52.
	La liaison avec la base est bonne.

Mode veille













Toutes les descriptions contenues dans ce mode d'emploi partent du principe que le combiné se trouve en mode veille. Le combiné se trouve en mode veille quand aucune communication n'est passée et qu'aucun menu n'est ouvert. Appuyez, le cas échéant, plusieurs fois sur la touche  pour accéder au mode veille.

¹ **VMWI: Visual Message Waiting Indication** = Affichage optique de nouveaux messages.

Introduction

Navigation dans le menu

Vous pouvez accéder à toutes les fonctions via différents menus. La structure de menu vous montre comment accéder à la fonction désirée  page 41.











	Ouvrir le menu principal
 / 	Sélectionner le sous-menu voulu
	Ouvrir le sous-menu
 / 	Sélectionner la fonction voulue
	Ouvrir la fonction
 / 	Sélectionner la fonction voulue
	Saisir des chiffres ou des lettres via le clavier numérique
	Confirmer les saisies
	Reculer d'une position
	Annuler les opérations de programmation et de sauvegarde et retourner en mode veille



Chaque opération est automatiquement interrompue si vous n'effectuez pas de saisie dans les 20 secondes.

Ajouter des contacts dans le répertoire - exemple





L'exemple **Ajouter des contacts dans le répertoire** vous explique ici comment naviguer dans les menus et réaliser des réglages. Pour toutes les programmations, procédez comme dans cet exemple.

	Ouvrir le menu principal
 /  REPertoire 	Ouvrir le répertoire
 AJOUTER 	Sélectionner le sous-menu et valider
 	Saisir le nom (max. 12 chiffres) et valider
 	Saisir le numéro d'appel (max. 20 chiffres) et valider





Structure du menu

5 Structure du menu

Menu principal

Vous accédez au menu principal en appuyant sur la touche . Ensuite, sélectionnez un contact à l'aide des touches  /  et validez avec la touche . Pour obtenir d'autres informations relatives au menu et à la manipulation  chapitre 4.

REPERTOIRE

AJOUTER	ENTRER NOM  ¹	NUMERO 
MODIFIER	ENTRER NOM 	NUMERO 
EFFACER		
EFFACER TOUT	CONFIRMER?	
MELODIE GROUPE	NON, 1 - 12	
NUM. RAPIDE	AJOUTER	CHOIS TOUCHE 1 - 9
	EFFACER	CHOIS TOUCHE 1 - 9
STATUS MEMOIRE		



HORL./REVEIL

DATE & HEURE		
REGLER REV.	UNE FOIS	OUI 
		NON
	TS LES JOURS	OUI 
		NON

¹ Des lettres sont gravées sur les touches numériques. En appuyant plusieurs fois sur la touche adéquate, vous pouvez saisir des lettres, des chiffres et des symboles.







Structure du menu

MENU COMBINÉ

MELODIES	VOLUME SON.	VOLUME
	MELODIE	MELODIE
	INTERPHONE	MELODIE
	BIPS TOUCHES	OUI / NON
	BATTER. VIDE	OUI / NON
	HORS PORTÉE	OUI / NON
BOOSTER	OUI / AUTO / NON	
CONTRASTE	01 - 06	
NOM COMBINÉ		
DECROCH AUTO	OUI / NON	
LANGUE		
BABY CALL	ENTRER NUM.	
	APPEL DE BEBE MARCHE	OUI / NON

Structure du menu

MENU BASE

MSG VOC DESA ¹	CONFIRMER?	
ASSOCIER	BASE 1 - 4	CODE? ² 
CHOIX BASE	BASE 1 - 4 / AUTO	
REG. AVANCES		
CODE? 	MODE NUM.	FREQ VOCALES / NUM DECIMALE
	DUREE FLASH	100 MS / 300 MS / 600 MS
	CODE ZONE	
	PRÉFIXE	
	BLOQUAGE	OPTION 1 - 4 ENTRER NUM. 
	NUMERO SOS	OPTION 1 - 4 ENTRER NUM. 
	SUPPRIMER	COMBINE X
	CHANGER PIN	CODE? 
	DEFAULT	CONFIRMER?

¹ **VMWI: Visual Message Waiting Indication** = Affichage optique de nouveaux messages.

² Le code PIN est réglé en usine sur "0000".

Répertoire

6 Répertoire

Vous pouvez enregistrer 60 numéros d'appel et le nom y afférant dans votre répertoire.

- Saisissez toujours les numéros d'appel avec l'indicatif afin que le téléphone puisse aussi attribuer les communications locales entrantes à un contact du répertoire.
- Si la capacité de mémoire est épuisée, l'écran affiche le message suivant **MEM. PLEINE** à la sauvegarde suivante. Pour créer de la place, vous devez tout d'abord effacer un autre contact.
- Les contacts du répertoire sont rangés par ordre alphabétique.

Saisir le nom

Des lettres sont gravées sur les touches numériques. En appuyant plusieurs fois sur la touche adéquate, vous pouvez saisir des lettres, des chiffres et des symboles.

	Entrer des espaces
	Entrer les caractères spéciaux
	Effacer
	Déplacer le curseur



Pour saisir deux fois la même lettre, appuyez sur la touche correspondante. Attendez que le curseur soit passé derrière la lettre. Puis tapez la lettre une nouvelle fois.

Ajouter des contacts dans le répertoire

	Ouvrir le répertoire
AJOUTER	Sélectionner le sous-menu et valider
	Saisir le nom (max. 12 chiffres) et valider
	Saisir le numéro d'appel (max. 20 chiffres) et valider

Modifier des contacts dans le répertoire

	Ouvrir le répertoire
	Sélectionner le contact et valider
MODIFIER	Sélectionner le sous-menu et valider
	Modifier le numéro d'appel et valider
	Modifier le numéro d'appel et valider

Liste d'appels

Effacer des contacts du répertoire

Effacer un contact

	Ouvrir le répertoire
/ ,	Sélectionner le contact, valider
/ , EFFACER	Sélectionner le sous-menu et valider

Effacer tous les contacts

	Ouvrir le répertoire
, / , EFFACER TOUT	Sélectionner le sous-menu et valider
CONFIRMER? , ou	Confirmer l'effacement ou annuler

7 Liste d'appels

50 numéros d'appel en tout peuvent être sauvegardés dans une liste d'appels.



L'affichage du numéro d'appel (**CLIP**¹) est un service confort de votre opérateur. Votre téléphone affiche les numéros d'appel à l'écran si votre opérateur offre ce service. Veuillez lui demander de plus amples informations.

Faire afficher des numéros de la liste d'appels

, /	Ouvrir la liste d'appels et sélectionner un contact
------	-----------------------------------------------------

Sauvegarder dans le répertoire des numéros d'appel de la liste d'appels

Vous pouvez enregistrer un numéro d'appel dans le répertoire directement à partir de la liste d'appels.

, /	Ouvrir la liste d'appels et sélectionner un contact
	Ouvrir le menu
/	
ENREG NUMERO ,	Sélectionner le sous-menu et valider
,	Saisir le nom (max. 12 chiffres) et valider
,	Modifier le numéro d'appel et valider

¹ **CLIP** : Calling Line Identification Presentation = Affichage du numéro d'appel d'un correspondant.

Téléphoner

Effacer des numéros de la liste d'appels

Effacer des numéros individuels



Ouvrir la liste d'appels et sélectionner un contact



Ouvrir le menu

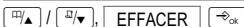

Sélectionner le sous-menu et valider

Effacer tous les numéros d'appel



Ouvrir la liste d'appels



Ouvrir le menu



Sélectionner le sous-menu et valider

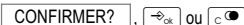

Confirmer l'effacement ou annuler

8 Téléphoner

Prendre un appel



Prendre la communication

Terminer la communication



Terminer la communication

Appeler



Composer le numéro d'appel (max. 32 chiffres)



En cas de saisie erronée, effacer le dernier chiffre



Composer le numéro



Vous pouvez aussi appuyer d'abord sur la touche , vous obtenez ainsi la tonalité. Les chiffres saisis de votre numéro d'appel seront immédiatement composés. Une correction individuelle des chiffres du numéro n'est pas possible quand la communication est établie de cette manière.

Répétition des derniers numéros

Votre téléphone enregistre les 20 derniers numéros composés dans une liste de répétition des derniers numéros.

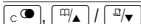

Ouvrir la liste de répétition des derniers numéros et sélectionner un contact



Établir la communication

Téléphoner

L'édition de numéros d'appel placés dans une liste de répétition des derniers numéros est identique à celle des numéros de la liste d'appels  chapitre 7.

Rappeler des numéros d'appel entrés

Votre téléphone enregistre 50 numéros d'appel dans une liste d'appels.

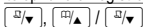

Ouvrir la liste d'appels et sélectionner un contact



Établir la communication

Composer des numéros d'appel à partir du répertoire

Vous devez avoir enregistré des numéros dans le répertoire  page 44 .

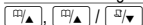

Ouvrir le répertoire et sélectionner le contact



Établir la communication

Téléphoner en interne¹

Téléphoner en interne

Vous devez avoir déclaré deux ou plusieurs combinés (CB1, CB2, ...) sur votre base afin de pouvoir téléphoner gratuitement en interne.



Activer la communication en interne



Composer le numéro d'appel interne du combiné voulu



Prendre une communication interne sur un autre combiné

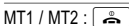

Terminer une communication interne

Transférer des communications externes en interne



Pendant la communication externe,



Composer le numéro d'appel interne



Prendre une communication interne sur un autre combiné















Transférer une communication

¹ Téléphoner en interne n'est possible qu'avec au moins deux combinés  "Contrôler le contenu du coffret" à la page 33.













Téléphoner

Intercommunication / Va-et-vient

 ,  / 	
INTERPHONE , 	Pendant la communication externe,
 /  , 	Composer le numéro d'appel interne
MT2 : 	Prendre une communication interne sur un autre combiné
 ,  / 	
COMMUTATION 	Changer de correspondant

Mener des conférences téléphoniques

Une communication externe peut être transformée en conférence téléphonique avec un autre correspondant interne.

 ,  / 	
INTERPHONE , 	Pendant la communication externe,
 /  , 	Composer le numéro d'appel interne
MT2 : 	Prendre une communication interne sur un autre combiné
 ,  / 	
CONFERENCE , 	Commencer la conférence
MT1 / MT2 : 	Terminer la conférence

Régler le volume sonore de l'écouteur

Vous pouvez régler le volume sonore sur 5 sensibilités pendant une communication.

 / 	Sélectionner le volume voulu
-----------------------------------------------------------------------------------------------------------------------------------------------------------------------	------------------------------

Affichage de la durée de la communication

La durée d'une communication est affichée en heures, minutes et secondes.

Désactiver la sonnerie

Vous pouvez désactiver la sonnerie du combiné.

3 sec. 	Désactiver la sonnerie
3 sec. 	Activer la sonnerie

Mode mains-libres

Utilisez cette fonction pour entendre le correspondant par l'intermédiaire du haut-parleur.

	Activer le mode mains-libres
	Désactiver le mode mains-libres

Téléphoner

Mettre le microphone du combiné sur muet

Pendant une communication, vous pouvez activer et désactiver le microphone du combiné.



Désactiver le microphone (le mettre sur silencieux)

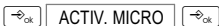

Activer le microphone

Verrouillage des touches

Le verrouillage des touches doit empêcher que des fonctions soient déclenchées par inadvertance.



Activer le verrouillage du clavier



Lorsque le verrouillage du clavier est activé, vous pouvez comme d'habitude réceptionner des appels entrants.



Désactiver le verrouillage du clavier

Chercher le combiné (Paging)

Si vous avez égaré votre combiné, vous pouvez le retrouver facilement grâce à un son de recherche.

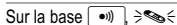

Lancer le son de recherche

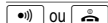

Arrêter le son de recherche

Élargissement du système téléphonique

9 Élargissement du système téléphonique

Le mode standard international normé **GAP**¹ règle la compatibilité entre les combinés et les bases de fabricants différents. Il est ainsi possible d'intégrer ensemble des appareils SWITEL et des appareils d'autres fabricants dans un système téléphonique. Il est toutefois possible que certaines fonctions ne soient pas disponibles.

Plusieurs combinés



Vous pouvez déclarer 6 combinés sur votre base.

Déclaration de combinés

Avant de déclarer un combiné, vous devez mettre la base en mode de déclaration.

10 sec. 

Démarrer le mode de déclaration

Déclarez maintenant le combiné  chapitre 5. Pour la déclaration, utilisez le code PIN actuellement paramétré  chapitre 5.

Après la déclaration, un numéro d'appel interne est attribué au combiné. Ce numéro interne s'affiche.



Pour déclarer des combinés d'autres fabricants, veuillez lire leur mode d'emploi.

Annulation de combinés



Vous ne pouvez annuler un combiné d'une base que par un autre combiné déclaré sur cette base.

Les combinés s'annulent via le menu. Vous trouverez la position dans le menu au chapitre 5.

Plusieurs bases

Vous pouvez élargir la portée de votre combiné si vous le déclarez sur plusieurs bases. Il peut être déclaré simultanément sur 4 bases différentes. Chaque base a besoin d'une prise téléphonique individuelle. Ces raccordements peuvent porter le même numéro d'appel ou bien des numéros différents.



Les communications en cours ne peuvent pas être transférées d'une base à l'autre.

¹ **GAP: Generic Access Profile** = Standard pour l'action conjointe de combinés et de bases de fabricants différents.

10 Fonctions particulières



Système de numérotation

Vous pouvez utiliser votre téléphone tant avec les centrales téléphoniques analogiques (numérotation par impulsions) qu'avec les nouvelles centrales téléphoniques numériques (numérotation par tonalité). Le système de numérotation est programmé via le menu. La page 43 vous donnera la position dans le menu.

Réveil

Cette fonction vous permet de vous faire réveiller par votre combiné à un moment précis.

Appel bébé

Cette fonction vous permet de sauvegarder un numéro d'appel précis qui sera automatiquement appelé quand vous appuyerez sur une touche quelconque (sauf  et ).

blochage d'appel

Le blocage d'appel empêche les combinés de composer des numéros que vous avez enregistrés. Vous pouvez enregistrer 4 numéros de blocage d'appel pouvant se composer de 8 chiffres. La page 43 vous donnera la position dans le menu.

Numéros SOS

Vous pouvez enregistrer jusqu'à 4 numéros d'appel pouvant être composés malgré le blocage d'appel activé. La page 43 vous donnera la position dans le menu.

11 Installations à postes supplémentaires / Services confort

Touche R et services confort

Votre téléphone supporte des services confort de votre opérateur tels que le va-et-vient, la signalisation d'appel en instance et la conférence. Vous pouvez les utiliser via la touche . Demandez à votre opérateur le temps de flash à paramétrer pour utiliser ces services conforfs. Contactez-le pour déconnecter ces services. Le temps de flash se paramètre via le menu. La page 43 vous donnera la position dans le menu.

Touche R sur des installations PABX

Si votre téléphone est raccordé à une installation PABX, vous pouvez, via la touche , bénéficier de certaines fonctions comme par ex. le transfert d'appels et le rappel automatique. Veuillez lire dans le mode d'emploi de votre installation PABX le temps de flash à paramétrer pour l'utilisation de ces fonctions. Le revendeur auprès duquel vous avez acheté l'installation vous dira si votre téléphone fonctionne parfaitement sur votre installation PABX. Le temps de flash se paramètre via le menu. La page 43 vous donnera la position dans le menu.

En cas de problèmes

Pause de numérotation

Dans le cas d'installations PABX, il faut composer auparavant un code réseau pour obtenir la tonalité. Sur quelques installations PABX plus anciennes, vous devez attendre quelques instants avant de pouvoir entendre la tonalité. Pour ces installations PABX, une pause de numérotation peut être insérée après le code réseau afin de pouvoir continuer à numéroté directement sans attendre la tonalité. Vous insérez la pause de numérotation en appuyant 3 sec. sur la touche .

Après le code réseau, le numéro d'appel proprement dit est composé au bout d'un temps déterminé.



La pause peut également être enregistrée lors de la saisie de numéros d'appel dans le répertoire.

Affichage du numéro d'appel (CLIP¹)



L'affichage du numéro d'appel est un service confort de votre opérateur. Veuillez lui demander de plus amples informations.

Si cette fonction est disponible sur votre ligne téléphonique, le numéro d'appel du correspondant vous sera affiché dès que le téléphone sonnera. Si votre correspondant a bloqué la transmission de son numéro, un message correspondant sera affiché. Le numéro d'appel ne peut pas être affiché et ne peut donc être enregistré dans la liste d'appels.

Répondeur dans le réseau téléphonique

Le répondeur dans le réseau téléphonique est un service confort offert par de nombreux opérateurs. Si votre opérateur met à votre disposition un répondeur dans le réseau téléphonique, vous serez informé par une icône de l'arrivée de nouveaux messages (VMWI²). Vous ne pouvez disposer de cette fonction que si votre opérateur offre ce service confort. Veuillez lui demander de plus amples informations.

12 En cas de problèmes

Hotline de service

Si vous avez des problèmes avec votre téléphone, observez d'abord les remarques suivantes. S'il s'agit de problèmes techniques, vous pouvez vous adresser à notre hotline de service en Suisse au numéro de tél. 0900 00 1675 (frais Swisscom à la date d'impression de ce manuel : CHF 2,60/min). Si vous jouissez de droits de garantie, adressez-vous à votre revendeur. La durée de la garantie est de 2 ans.

¹ **CLIP** : Calling Line Identification Presentation = Affichage du numéro d'appel d'un correspondant.

² **VMWI** : Visual Message Waiting Indication = Affichage optique de nouveaux messages.

En cas de problèmes

Questions et réponses

Questions	Réponses
Pas de communication téléphonique possible	<ul style="list-style-type: none">- Le téléphone n'est pas raccordé correctement ou est en dérangement. N'utilisez que le câble de raccordement téléphonique fourni avec l'appareil.- Testez avec un autre téléphone si votre raccordement téléphonique fonctionne.- Le bloc secteur n'est pas branché ou il y a une panne totale de courant.- Les batteries rechargeables sont vides ou défectueuses.- Vous vous êtes trop éloigné de la base.- Réglage erroné du système de numérotation ☞ page 43.
Pas de connexion possible avec la base	<ul style="list-style-type: none">- Contrôlez que vous vous êtes déclaré sur la base avec le code PIN correct ☞ page 43.
La liaison est hachée, coupée	<ul style="list-style-type: none">- Vous vous êtes trop éloigné de la base.- Mauvais lieu d'installation de la base.
Le système ne réagit plus	<ul style="list-style-type: none">- Remettez toutes les fonctions en configuration usine ☞ page 43.- Retirez le bloc secteur de la prise de courant pendant un court instant.
Les piles rechargeables se vident très rapidement	<ul style="list-style-type: none">- Les piles rechargeables sont vides ou défectueuses.- Placez le combiné correctement sur la base. Nettoyez les surfaces de contact du combiné et de la base avec un chiffon doux et sec.- Posez le combiné sur la base et laissez-le pendant 16 heures .
L'affichage du numéro d'appel (CLIP) ne fonctionne pas	<ul style="list-style-type: none">- L'affichage du numéro d'appel est un service confort de votre opérateur. Veuillez lui demander de plus amples informations.- Le correspondant a bloqué la transmission de son numéro d'appel.

Caractéristiques techniques

13 Caractéristiques techniques

Caractéristiques techniques

Caractéristique	Valeur
Standard	DECT ¹ -GAP ²
Alimentation en courant (base)	Entrée : 230 V, 50 Hz Sortie : 7,5 V, 300 mA
Alimentation en courant (chargeur)	Entrée : 230 V, 50 Hz Sortie : 7,5 V, 100 mA
Portée	À l'extérieur : env. 300 m À l'intérieur : env. 50 m
Autonomie en veille	Jusqu'à 100 h
Durée max. de communication	Jusqu'à 10 h
Piles rechargeables	2 x AAA NiMH 1,2 V
Système de numérotation	Numérotation par tonalité Numérotation par impulsions
Fonction de flash	100 ms, 300 ms, 600 ms

Déclaration de conformité

Cet appareil répond aux exigences des directives de l'union européenne (UE) : 1999/5/CE : Directive sur les installations de radio et de télécommunication et la reconnaissance réciproque de leur conformité. La conformité à la directive ci-dessus est confirmée sur l'appareil par le symbole CE.

Pour obtenir la déclaration de conformité intégrale, veuillez vous servir du téléchargement gratuit de notre site Internet www.switel.com.



¹ **DECT**: Digital Enhanced Cordless Telecommunication = Standard pour les téléphones sans fil.

² **GAP** : Generic Access Profile = Standard pour l'action conjointe de combinés et de bases de fabricants différents.

Remarques d'entretien / Garantie

14 Remarques d'entretien / Garantie

Remarques d'entretien

- Nettoyez les surfaces du boîtier avec un chiffon doux et non pelucheux.
- N'utilisez pas de produits d'entretien ou de solvants.

Garantie

Les appareils SWITEL sont fabriqués et contrôlés selon les procédés les plus modernes. Des matériaux sélectionnés et des technologies de pointe garantissent un fonctionnement irréprochable et une longue durée de vie. La garantie ne rentre pas en jeu si l'exploitant du réseau téléphonique ou une installation PABX éventuellement intercalée est responsable du dysfonctionnement de l'appareil. La garantie ne s'applique pas aux batteries, batteries rechargeables ou packs de batteries rechargeables utilisés dans les produits. La durée de la garantie est de 24 mois à partir de la date d'achat. Pendant la période de garantie, tous les défauts dus à des vices de matériel ou de fabrication seront éliminés gratuitement. Le droit à la garantie expire en cas d'intervention de l'acheteur ou de tiers. Les dommages provenant d'un maniement ou d'une manipulation incorrects, d'une usure naturelle, d'une mauvaise mise en place ou d'une mauvaise conservation, d'un raccordement ou d'une installation incorrects ainsi que d'un cas de force majeure ou autres influences extérieures sont exclus de la garantie. En cas de réclamations, nous nous réservons le droit de réparer, de remplacer les pièces défectueuses ou d'échanger l'appareil. Les composants remplacés ou les appareils échangés deviennent notre propriété. Les demandes de dommages et intérêts sont exclues tant qu'elles ne reposent pas sur l'intention ou une négligence grossière du fabricant.

Si votre appareil devait malgré tout présenter une défectuosité pendant la période de garantie, veuillez vous adresser, muni de votre reçu, exclusivement au magasin où vous avez acheté votre appareil SWITEL. Vous ne pouvez faire valoir vos droits à la garantie selon ces dispositions qu'exclusivement auprès de votre revendeur. Deux ans après l'achat et la remise de nos produits, il n'est plus possible de faire valoir les droits en matière de garantie.

Index

15 Index

A

Affichage des numéros d'appel, 45
Affichage du numéro d'appel, 52
Ajouter des, 40
Annulation, 50
Appel bébé, 51
Appel d'urgence, 51
Appeler, 46

B

Base, 34, 50
Blocage d'appel, 51

C

Caractéristiques techniques, 54
Chercher, 49
CLIP, 52
Combiné, 50
Communications internes, 47
Composer des numéros, 47
Conférences téléphoniques, 48
Consignes de sécurité, 32
Contacts dans le répertoire, 44
contacts dans le répertoire, 40
Contenu du coffret, 33

D

Date, 36
Déclaration, 50
Déclaration de conformité, 54
Durée de la communication, 48

E

Écran, 39
Effacer, 45, 46
Élargissement, 50
Éléments de manipulation, 37
Emploi, 38

F

Fonctions, 51

G

Garantie, 55

H

Heure, 36
Hotline de service, 52

I

Icônes, 39
Icônes à l'écran, 39
Insérer les piles rechargeables, 34
Installations à postes supplémentaires, 51
Intercommunication, 48

L

Langue de l'écran, 35
Liste d'appels, 45

M

- Menu principal, 41
- Mise du micro sur muet, 49
- Mise en service, 33
- Mise sur muet, 49
- Mode ÉCO, 36
- Mode mains-libres, 48
- Mode veille, 39
- Modifier, 44
- Montage mural, 35

N

- Niveau de charge des piles, 35
- Notations, 38

P

- Paging, 49
- Pause de numérotation, 52
- Prise d'appel, 36, 46
- Problèmes, 52

Q

- Questions et réponses, 53

R

- Raccrocher, 46
- Rappel, 47
- Recharger, 35
- Réduction du rayonnement, 36
- Remarques d'entretien, 55
- Répertoire, 44, 47
- Répétition des derniers numéros, 46
- Répondeur dans
le réseau téléphonique, 52
- Réveil, 51

S

- Saisie de nom, 44
- Saisie de texte, 44
- Sauvegarder, 40, 45
- Services confort, 51
- Sonnerie, 48
- Structure du menu, 41
- Suppression d'erreurs, 52
- Système de numérotation, 51

T

- Téléphoner, 46
- Terminer la communication, 46
- Touche R, 51
- Transfert, 47
- Transfert de communication, 47

V

- Va-et-vient, 48
- Verrouillage des touches, 49
- VMWI, 52
- Volume sonore de l'écouteur, 48

Notes

Notes

Contenuto

1	Indicazioni di sicurezza	60
2	Mettere in funzione il telefono	61
3	Elementi di comando	65
4	Informazioni introduttive	66
5	Struttura del menu	69
6	Rubrica telefonica	72
7	Elenco chiamate	73
8	Compiere telefonate	74
9	Ampliamento del sistema telefonico	78
10	Funzioni speciali	79
11	Impianti tel. interni / Servizi addizionali	79
12	In presenza di problemi	81
13	Specifiche tecniche	83
14	Consigli per la cura / Garanzia	84
15	Indice alfabetico	85

Indicazioni di sicurezza

1 Indicazioni di sicurezza

Leggere attentamente le presenti istruzioni per l'uso.

Impiego conforme agli usi previsti

Questo telefono consente di compiere telefonate in una rete telefonica. Qualsiasi altro impiego è considerato come non conforme agli usi previsti. Non sono consentite modifiche o trasformazioni non autorizzate. Non aprire per nessuna ragione l'apparecchio autonomamente, né compiere riparazioni di propria iniziativa.

Luogo di installazione

Evitare un'esposizione a fumo, polvere, vibrazioni, sostanze chimiche, umidità, calore e raggi solari diretti.

Non utilizzare il telefono in aree esposte al rischio di esplosioni.

Alimentatore di rete



Attenzione: Utilizzare solo l'alimentatore a spina fornito in dotazione visto che altri alimentatori di rete potrebbero addirittura danneggiare il telefono. Non ostacolare il libero accesso all'alimentatore a spina con mobili o oggetti simili.

Accumulatori ricaricabili



Attenzione: Non gettare gli accumulatori ricaricabili nel fuoco. Utilizzare solo accumulatori dello stesso tipo. Osservare la corretta polarità! Pericolo di esplosione in caso di inversione della polarità durante la carica degli accumulatori.

Caduta di tensione

In assenza di tensione non è possibile compiere chiamate con questo telefono. Si consiglia di ricorrere in caso di emergenza ad un telefono a filo in grado di funzionare anche senza alimentazione elettrica esterna.

Apparecchiature mediche



Attenzione: Non utilizzare il telefono in prossimità di apparecchiature mediche. Non è infatti possibile escludere il rischio di possibili interferenze.

Compatibilità con apparecchi acustici

Il telefono è compatibile con il maggior numero di apparecchi acustici presenti sul mercato. Ciò nonostante non è possibile garantire un perfetto funzionamento con qualsiasi tipo di apparecchio acustico.

Telefoni **DECT**¹ possono causare un fastidioso ronzio in apparecchi acustici.

¹ **DECT:** Digital Enhanced Cordless Telecommunication = Standard per telefoni senza cavo.

Mettere in funzione il telefono

Smaltimento

Smaltire l'apparecchio consegnandolo presso uno dei punti di raccolta istituiti dalla propria società di smaltimento rifiuti comunale (ad es. centro di riciclo materiali). La legge sugli apparecchi elettrici ed elettronici prescrive ai proprietari di apparecchi esauriti la consegna di tutti gli **apparecchi elettrici ed elettronici** presso un centro di rilievo rifiuti in raccolta differenziata. Il simbolo qui a lato indica che non è assolutamente consentito smaltire l'apparecchio assieme ai normali rifiuti domestici!



Accumulatori e batterie possono provocare danni alla salute e all'ambiente!



Non aprire, danneggiare, ingerire o disperdere nell'ambiente accumulatori e batterie. Questi possono contenere metalli pesanti nocivi ed essere dannosi per l'ambiente. Per legge sussiste l'obbligo di smaltire correttamente accumulatori e batterie utilizzando gli appositi contenitori di raccolta in uso presso i rivenditori di batterie. Lo smaltimento è gratuito. I simboli indicano che non è assolutamente consentito gettare accumulatori e batterie nei rifiuti domestici, consegnandoli ai fini dello smaltimento nei rispettivi punti di raccolta.

Smaltire **confezioni ed imballaggi** secondo quanto indicato dalle norme in vigore a livello locale.

2 Mettere in funzione il telefono

Indicazioni di sicurezza



Attenzione: Prima della messa in funzione, leggere attentamente le indicazioni di sicurezza riportate al capitolo 1.

Verificare il contenuto della confezione

La confezione contiene:

Contenuto	Modello DC68x ¹			
	681	682	683	684
Stazione base con alimentatore di rete	1	1	1	1
Stazione di carica con alimentatore di rete	-	1	2	3
Unità portatile	1	2	3	4
Cavo di collegamento telefonico	1	1	1	1

¹ Per ulteriori informazioni sulla disponibilità di questo telefono/set telefonico si prega di visitare il sito www.switel.com.

Mettere in funzione il telefono

Accumulatori	2	4	6	8
Istruzioni per l'uso	1	1	1	1

Collegare l'unità base



Attenzione: Montare l'unità base a una distanza minima di 1 m da altri apparecchi elettronici in modo da escludere interferenze reciproche.

Procedere al collegamento dell'unità base seguendo quanto raffigurato nella figura. Utilizzare per motivi di sicurezza solo l'alimentatore di rete oltre al cavo di collegamento telefonico fornito in dotazione.

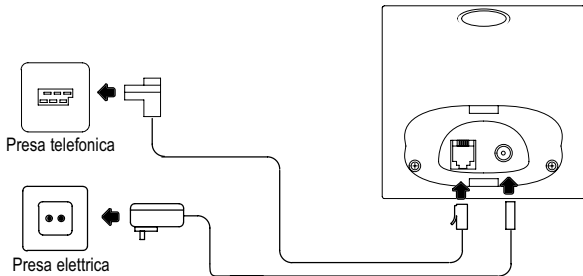

Utilizzare per la stazione base l'alimentatore di rete con codice SSA-5W-09 EU 075030F e dati di output 7,5 V, 300 mA.

Inserire gli accumulatori

Inserire gli accumulatori nel vano accumulatori precedentemente aperto. Utilizzare esclusivamente accumulatori di tipo AAA NiMH da 1,2 V. Osservare la corretta polarità! Chiudere infine il vano accumulatori.

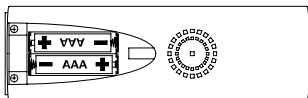
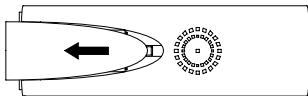

Mettere in funzione il telefono

Montaggio a parete

Il telefono è concepito per il montaggio a parete. Il fissaggio del telefono richiede due viti.



Avvertenza: Sincerarsi che nel settore in cui è prevista la trapanatura dei fori non vi siano linee e condutture (cavi, tubi e così via).

Prevedere due fori disposti orizzontalmente con una distanza di 55 mm tra loro e lasciare sporgere le viti di 5 mm dal muro. Rimuovere il supporto da tavolo della stazione base e girarla di 180°. Riapplicare quindi il supporto nella posizione a ciò preposta facendolo scattare in posizione in modo udibile. Poggiare i dispositivi di aggancio della stazione base sulle viti e tirarli in basso.

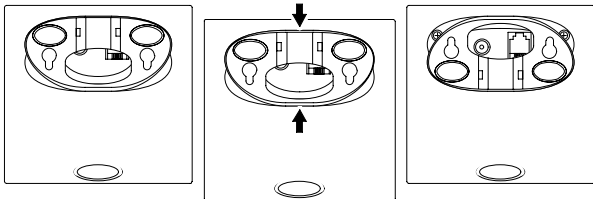

Mettere in funzione il telefono

Caricare gli accumulatori



Riporre l'unità portatile in sede di prima messa in funzione per **minimo 16 ore** nell'unità base / stazione di carica.

Una volta posizionato il portatile correttamente nella stazione base / stazione di carica, si avverte un segnale acustico di avviso. L'unità portatile si surriscalda durante il processo di carica. Questo è un fenomeno normale e non pericoloso. Evitare di caricare l'unità portatile con dispositivi di carica differenti o estranei. Lo **stato di carica** attuale è visualizzato sul display:



Carico



Metà carico



Debole



Scarico

Impostare la lingua di display

Selezionare la lingua che interessa (vedi anche "Struttura menu"):

 > EINSTELL.MT > SPRACHE >...

È possibile scegliere tra 13 lingue.

Impostare data e ora dell'unità portatile

Una voce di menu consente di impostare data e ora. A pagina 69 è indicata la posizione da scorrere nel menu.

Accettazione di chiamata automatica

L'attivazione di questa funzione consente di ricevere automaticamente una chiamata estraendo semplicemente l'unità portatile dalla stazione base. L'accettazione di chiamata automatica è attivata o disattivata nel menu. A pagina 70 è indicata la posizione da scorrere nel menu.

Impianti telefonici interni

A pagina 79 sono riportate ulteriori informazioni riguardo l'eventuale collegamento del telefono ad un impianto telefonico interno.

Riduzione delle radiazioni (modalità ECO)

Le radiazioni in modalità di stand-by sono state considerevolmente ridotte se paragonate a quelle emesse da telefoni cordless a standard DECT, con unità portatile nella base.

In modalità di conversazione, le radiazioni sono tanto basse quanto più piccola è la distanza dell'unità portatile dalla base.



Elementi di comando

3 Elementi di comando

I tasti del telefono illustrati in questo manuale d'istruzioni sono raffigurati come simboli uniformi all'interno di un riquadro. Sono possibili lievi scostamenti dei simboli dei tasti sul telefono rispetto ai simboli qui raffigurati.

Unità portatile

- 1 Ricevitore
- 2 Display LC
- 3 Tasto freccia su / Rubrica telefonica
- 4 Cancella / Ripetizione di chiamata
- 5 Tasto di riaggancio
- 6 Tasto freccia giù / Elenco chiamate
- 7 Tasti numerici
- 8 Tasto # / Segnale di chiamata spento
- 9 Microfono
- 10 Tasto * / Blocco tastiera
- 11 Tasto di chiamata / Funzione vivavoce
- 12 Tasto menu/Tasto OK
- 13 LED

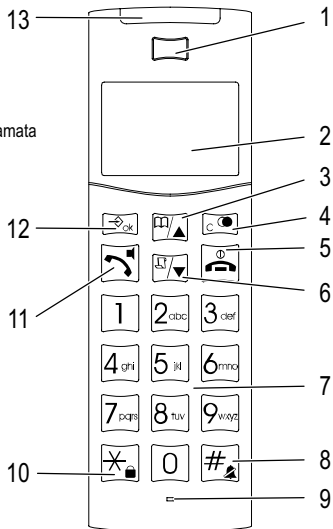

Informazioni introduttive

Stazione base



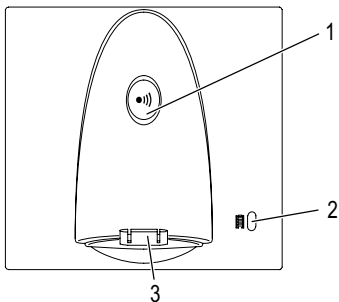





- 1 Tasto di paging
- 2 LED caricamento
- 3 Contatti di carica



4 Informazioni introduttive













Il capitolo riporta le principali informazioni sull'uso delle presenti istruzioni e del telefono.

Modi di rappresentazione nelle istruzioni per l'uso

Rappresentazione	Descrizione
	Rappresentazione dei tasti
	Premere brevemente il tasto raffigurato
2 sec. 	Premere il tasto raffigurato per 2 secondi
	Inserire numeri o lettere
	Unità portatile squilla
	Estrarre l'unità portatile dalla stazione base
	Riporre l'unità portatile nella stazione base
	Rappresentazione di testi sul display
	Rappresentazione di simboli sul display

Informazioni introduttive

Simboli e testi sul display dell'unità portatile

Simbolo	Descrizione
	Costante: indica lo stato di carica degli accumulatori. Scarico: gli accumulatori vanno caricati. Segmenti che scorrono: gli accumulatori sono in fase di ricarica ☞ pagina 64.
 	Condurre una chiamata ☞ pagina 74.
	Si è nel menu ☞ pagina 69.
	Si è nella rubrica telefonica ☞ pagina 72.
	Ci si trova nell'elenco chiamate. Presenza di nuove chiamate nell'elenco chiamate ☞ pagina 73.
	Segnalazione acustica di chiamata disinserita ☞ pagina 77.
	Microfono in modalità silenziamento ☞ pagina 77.
	Funzione vivavoce attivata ☞ pagina 77.
	Blocco tastiera attivato ☞ pagina 77.
	Sveglia attivata ☞ pagina 69.
	Segreteria telefonica integrata nella rete telefonica. VMWI ¹ - Servizio aggiuntivo del proprio gestore di rete telefonica ☞ pagina 80.
	Collegamento con la stazione base è buono.

Modalità di stand-by











In tutte le descrizioni del presente manuale di istruzioni si considera l'unità portatile in modalità di stand-by. L'unità portatile passa alla modalità di stand-by nel momento in cui non si svolge alcuna chiamata e con menu chiusi. Premere se occorre ripetutamente il tasto  per passare alla modalità di stand-by.

¹ **VMWI**: Visual Message Waiting Indication = Segnalazione ottica di nuovi messaggi.

Informazioni introduttive

Navigazione nel menu

I differenti menu consentono di raggiungere tutte le funzioni del telefono. Il percorso da seguire per giungere alla funzione desiderata è indicata dalla struttura di menu  pagina 69.









	Aprire il menu principale
	Selezionare il sottomenu richiesto
	Aprire il sottomenu
	Selezionare la funzione richiesta
	Aprire la funzione
	Selezionare l'impostazione richiesta
	La tastiera consente di inserire numeri o lettere
	Confermare l'immissione
	Tornare indietro di un livello
	Interrompere le procedure di programmazione e memorizzazione e tornare indietro alla modalità di stand-by



Ogni singolo processo si interrompe automaticamente se entro 20 secondi non si procede con una immissione.

Creare voci della rubrica telefonica - Esempio





La navigazione nei menu e la procedura da seguire per compiere impostazioni è indicata a titolo esemplificativo in **Creare voci della rubrica telefonica**. Si consiglia di seguire quanto riportato nell'esempio per tutte le impostazioni da compiere.

	Aprire il menu principale
 RUBRICA 	Aprire la rubrica telefonica
 NUOVA 	Selezionare il sottomenu e confermare
 	Immettere il nome (max. 12 segni) e confermare
 	Immettere il numero di chiamata (max. 20 cifre) e confermare





Struttura del menu

5 Struttura del menu

Menu principale

Per passare al menu principale, premere il tasto . Selezionare quindi una voce con i tasti  /  e confermare la scelta con il tasto . Maggiori informazioni su menu ed esercizio  capitolo 4.

RUBRICA

NUOVA	INSER NOME  ¹	NUMERO 
MODIFICA	INSER NOME 	NUMERO 
CANCELLA		
CANC TUTTI	OK?	
MELODIA VIP	DISATTIVA, 1 - 12	
CHIAM.RAPIDA	NUOVA	HOT KEY 1 - 9
	CANCELLA	HOT KEY 1 - 9
STATO MEM.		



OROL/SVEGLIA

DATA E ORA		
IMP. SVEGLIA	UNA VOLTA	ATTIVA 
		DISATTIVA
	GIORNALMENTE	ATTIVA 
		DISATTIVA

¹ I tasti numerici riportano altresì delle lettere. Premendo ripetutamente il relativo tasto si ha modo di selezionare lettere, cifre e caratteri speciali.







Struttura del menu

CONF.PORT.?

TONI RICEV.	VOL SUONERIA	VOLUME
	SUONERIA	SUONERIA 1-12
	INTERCOM	SUONERIA 1-12
	TONI CHIAVE	ATTIVA/DISATTIVA
	BT SCARICA	ATTIVA/DISATTIVA
	FUORI CAMPO	ATTIVA/DISATTIVA
FORTE	ATTIVA / AUTO / DISATTIVA	
CONTRASTO	01 - 06	
NOME RICEV.		
RISP. AUTOM.	ATTIVA/DISATTIVA	
LINGUA		
BABY CALL	INSER NUM	
	BABYCALL ON/OFF	ATTIVA/DISATTIVA

Struttura del menu

CONF.BASE?

VMWI SPENTO? ¹	OK?		
AFFILIA	BASE 1 - 4	PIN? ²	
SELEZIONA BS	BASE 1 - 4 / AUTO		
IMP AVANZATE			
PIN? 	MODAL CHIAM	TONI / IMPULSI	
	AVVISO RICH.	100 MS / 300 MS / 600 MS	
	CODICE AREA		
	PREFISSO		
	FILTRO CHIAM	OPTION 1 - 4	INSER NUM 
	NUMERO SOS	OPTION 1 - 4	INSER NUM 
	SCOLLEGARE	PORTATILE X	
	MODIFICA PIN	PIN? 	
	RESET	OK?	

¹ **VMWI: Visual Message Waiting Indication** = Segnalazione ottica di nuovi messaggi.

² Il codice PIN è impostato in fabbrica su "0000".

Rubrica telefonica

6 Rubrica telefonica

Nella rubrica telefonica è possibile memorizzare 60 numeri di chiamata con rispettivi nomi.

- Assegnare a tutti i numeri di chiamata sempre un prefisso in modo da poter riconoscere anche una chiamata urbana in arrivo ed abbinarla ad una voce presente nella rubrica telefonica.
- Con capacità di memoria esaurita, sul display è visualizzata l'indicazione **MEM PIENA** dopo aver memorizzato l'ultimo messaggio. Per poter disporre di nuovo spazio memoria, cancellare prima una voce già presente.
- Le voci della rubrica telefonica sono elencate in ordine alfabetico.

Immettere nomi

I tasti numerici riportano altresì delle lettere. Premendo ripetutamente il relativo tasto si ha modo di selezionare lettere, cifre e caratteri speciali.

	Immettere spazi vuoti
	Immettere caratteri speciali
	Cancellare
	Spostare il cursore



Per immettere la stessa lettera una seconda volta, premere il rispettivo tasto. Attendere fino a quando il cursore si sia spostato di una posizione. Immettere quindi la lettera una seconda volta.

Creare voci della rubrica telefonica

	Aprire la rubrica telefonica
NUOVA	Selezionare il sottomenu e confermare
	Immettere il nome (max. 12 segni) e confermare
	Immettere il numero di chiamata (max. 20 cifre) e confermare

Modificare voci nella rubrica telefonica

	Aprire la rubrica telefonica
	Selezionare la voce e confermare
MODIFICA	Selezionare il sottomenu e confermare
	Modificare il nome e confermare
	Modificare il numero di chiamata e confermare

Elenco chiamate

Cancellare voci nella rubrica telefonica

Cancellare una voce

	Aprire la rubrica telefonica
/ ,	Selezionare la voce e confermare
/ , CANCELLA	Selezionare il sottomenu e confermare

Cancellare tutte le voci

	Aprire la rubrica telefonica
, / , CANC TUTTI	Selezionare il sottomenu e confermare
OK? , o	Confermare o interrompere la procedura di cancellazione

7 Elenco chiamate

All'interno dell'elenco chiamate è possibile memorizzare in tutto 50 numeri telefonici.



La visualizzazione del numero di chiamata (**CLIP**¹) è un servizio aggiuntivo del proprio gestore di rete telefonica. Nel caso in cui il gestore di rete telefonica supporti il servizio, sul display del telefono è visualizzato il numero di chiamata. Per maggiori dettagli a riguardo, rivolgersi al proprio gestore di rete telefonica.

Visualizzare numeri di chiamata dall'elenco chiamate

, /	Aprire l'elenco chiamate e selezionare una voce
------	-------------------------------------------------

Memorizzare nella rubrica un numero di chiamata dall'elenco chiamate

È possibile memorizzare un numero di chiamata direttamente dall'elenco chiamate nella rubrica telefonica.

, /	Aprire l'elenco chiamate e selezionare una voce
	Aprire il menu
/ SALVA NUMERO	Selezionare il sottomenu e confermare
,	Immettere il nome (max. 12 segni) e confermare
,	Modificare il numero di chiamata e confermare

¹ **CLIP**: Calling Line Identification Presentation = Visualizzazione del numero telefonico del chiamante.

Compiere telefonate

Cancellare numeri di chiamata dall'elenco chiamate

Cancellare singoli numeri di chiamata

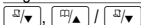

Aprire l'elenco chiamate e selezionare una voce



Aprire il menu



Selezionare il sottomenu e confermare

Cancellare tutti i numeri di chiamata



Aprire l'elenco chiamate



Aprire il menu



Selezionare il sottomenu e confermare



Confermare o interrompere la procedura di cancellazione

8 Compiere telefonate

Accettare una chiamata



Ricevere una chiamata

Concludere una chiamata



Concludere una chiamata

Compiere telefonate



Immettere un numero di chiamata (max. 32 cifre)



In caso di immissione errata, cancellare l'ultima cifra



Selezionare un numero di chiamata



È altresì possibile premere prima il tasto  e ottenere quindi il segnale di linea libera. Le cifre immesse per la composizione del numero di chiamata desiderato sono immediatamente selezionate. Nel corso di una simile chiamata non è possibile eseguire la correzione di singole cifre che compongono il numero di chiamata.

Compiere telefonate

Ripetizione di chiamata

Il telefono memorizza i 20 ultimi numeri di chiamata selezionati all'interno di un elenco di ripetizione di chiamata.



Aprire l'elenco di ripetizione di chiamata e selezionare una voce



Instaurare un collegamento

Per modificare i numeri di chiamata presenti nell'elenco di ripetizione di chiamata, seguire la procedura descritta per i numeri di chiamata dell'elenco chiamate ➤ capitolo 7.

Richiamare un interlocutore perso

Il telefono memorizza 50 numeri telefonici in un elenco chiamate.

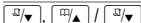

Aprire l'elenco chiamate e selezionare una voce



Instaurare un collegamento

Selezionare numeri di chiamata dalla rubrica telefonica

Per fare questo è necessario aver precedentemente memorizzato dei numeri nella rubrica telefonica ➤ pagina 72.



Aprire la rubrica telefonica e selezionare una voce



Instaurare il collegamento

Compiere chiamate interne¹

Condurre chiamate interne

Per condurre telefonate interne gratuite bisogna aver registrato due o più unità portatili (UP1, UP2, ...) presso la stazione base.



Avviare una chiamata interna

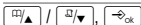

Selezionare il numero di chiamata del portatile richiesto



Accettare una telefonata interna presso l'altra unità portatile

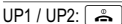









Concludere la telefonata interna













¹ Per compiere telefonate interne sono necessarie minimo due unità portatili ➤ "Verificare il contenuto della confezione" a pagina 61.

Compiere telefonate

Trasferire internamente chiamate esterne













 ,  / 	
INTERCOM , 	Con chiamata esterna in corso
 /  , 	Selezionare il numero di chiamata interno
UP2: 	Accettare una telefonata interna presso l'altra unità portatile
UP1: 	Trasferire la chiamata

Riscontro / Chiamata in attesa

 ,  / 	
INTERCOM , 	Con chiamata esterna in corso
 /  , 	Selezionare il numero di chiamata interno
UP2: 	Accettare una telefonata interna presso l'altra unità portatile
 ,  / 	
COMMUTA , 	Saltare tra i partner di chiamata

Condurre chiamate a conferenza

Questa funzione consente di condurre una conferenza con una chiamata esterna ed un altro interlocutore interno.

 ,  / 	
INTERCOM , 	Con chiamata esterna in corso
 /  , 	Selezionare il numero di chiamata interno
UP2: 	Accettare una telefonata interna presso l'altra unità portatile
 ,  / 	
CONFERENZA , 	Avviare una chiamata in conferenza
UP1 / UP2: 	Concludere la chiamata in conferenza

Impostare il volume del ricevitore

Il volume è regolabile durante lo svolgimento di una chiamata in 5 livelli.

 / 	Selezionare il volume richiesto
---------------------------------------------------------------------------------------------------------------------------------------------------------------------------	---------------------------------

Visualizzare la durata di conversazione

Durante lo svolgimento di una chiamata, la durata di conversazione è visualizzata in ore, minuti e secondi sul display.

Compiere telefonate

Disattivare il segnale di chiamata

Il segnale di chiamata dell'unità portatile può essere disattivato

3 sec. 

Disattivare il segnale di chiamata

3 sec. 

Attivare il segnale di chiamata

Funzione vivavoce

Utilizzare questa funzione per ascoltare il partner di chiamata attraverso l'altoparlante.



Avviare la funzione vivavoce



Disattivare la funzione vivavoce

Silenziamento del microfono nell'unità portatile

È possibile attivare e disattivare il microfono dell'unità portatile con chiamata telefonica in corso.



SILENZIO



Disattivare il microfono (silenziamento)



DISATTIVA



Attivare il microfono

Blocco tastiera

Il blocco tastiera aiuta ad impedire l'attivazione inavvertita di determinate funzioni.

3 sec. 

Attivare il blocco tastiera





L'attivazione del blocco tastiera consente di ricevere telefonate in arrivo come di consueto.

3 sec. 

Disattivare il blocco tastiera

Cercare l'unità portatile (funzione di paging)

Avendo perso d'occhio la propria unità portatile è possibile ritrovarla facilmente grazie all'emissione di un tono di ricerca.

Presso la base  

Avviare il tono di ricerca



Concludere il tono di ricerca

Ampliamento del sistema telefonico

9 Ampliamento del sistema telefonico

Lo standard internazionale **GAP**¹ regola la compatibilità di unità portatili e stazioni base di costruttori differenti. In tal modo è possibile adoperare apparecchi SWITEL in combinazione con apparecchi di altri costruttori all'interno di un unico sistema telefonico. Può comunque verificarsi la mancata disponibilità di alcune funzioni.

Maggior numero di unità portatili



È possibile registrare complessivamente fino a 6 unità portatili presso la propria stazione base.

Selezionare unità portatili

Prima di selezionare un'unità portatile, passare con la stazione base alla modalità di selezione.

10 sec. 

Avviare la modalità di registrazione

Registrare quindi l'unità portatile  capitolo 5. Utilizzare ai fini della registrazione il codice PIN attualmente impostato  capitolo 5.

Una volta eseguita la selezione, all'unità portatile è assegnato un numero di chiamata interno. Questo numero di chiamata interno è visualizzato sul display.



Per selezionare unità portatili di altri costruttori, leggere prima le rispettive istruzioni per l'uso.

Deselezionare unità portatili



La deselegazione di un'unità portatile da una stazione base è possibile solo attraverso un'altra unità portatile registrata a sua volta alla stazione base in questione.

Unità portatili sono deselezionate tramite menu. Nel capitolo 5 è possibile individuare la posizione nel menu.

Maggior numero di stazioni base

La portata della propria unità portatile può essere aumentata registrando l'apparecchio ad un numero maggiore di stazioni base. È possibile registrarsi contemporaneamente presso 4 stazioni base differenti. Ogni stazione base necessita di una propria presa telefonica. Si può trattare di allacciamenti con lo stesso o differente numero di chiamata.



Per chiamate in corso non è invece possibile compiere un trasferimento da una stazione base all'altra.

¹ **GAP: Generic Access Profile** = Standard per l'interazione di unità portatili e stazioni base di altri costruttori.

10 Funzioni speciali



Procedura di selezione

Il presente telefono funziona sia all'interno di sistemi telefonici analogici (procedura di selezione a impulsi), sia se integrato in moderni sistemi telefonici digitali (procedura di selezione a toni). La procedura di selezione è impostata tramite menu. A pagina 71 è indicata la posizione da scorrere nel menu.

Sveglia

Con la funzione è possibile farsi svegliare dalla propria unità portatile all'orario precedentemente impostato.

Funzione sorveglianza-bébé

Con questa funzione è dato modo di memorizzare un determinato numero di chiamata che sarà richiamato automaticamente premendo un tasto qualsiasi (tranne  e ).

Blocco di chiamata

Il blocco di numeri di chiamata impedisce a unità portatili di selezionare determinati numeri di chiamata precedentemente memorizzati. L'apparecchio consente la memorizzazione di 4 numeri di chiamata da bloccare composti da rispettivamente 8 cifre.

A pagina 71 è indicata la posizione da scorrere nel menu.

Numero SOS

È possibile memorizzare fino a 4 numeri di chiamata selezionabili nonostante l'attivazione del blocco di numeri di chiamata. A pagina 71 è indicata la posizione da scorrere nel menu.

11 Impianti tel. interni / Servizi aggiuntivi

Tasto R e servizi aggiuntivi

Il telefono supporta servizi aggiuntivi messi a disposizione dal proprio gestore di rete telefonica come ad es. le funzioni di chiamata in attesa, avviso di chiamata e chiamata a conferenza. Il tasto  consente di accedere a questi servizi aggiuntivi. Si prega di consultare il proprio gestore di rete telefonica per ottenere informazioni sul tempo flash necessario all'utilizzo dei servizi aggiuntivi. Rivolgersi al proprio gestore di rete telefonica per ottenere l'abilitazione ai servizi aggiuntivi. Il tempo flash è impostato tramite menu. A pagina 71 è indicata la posizione da scorrere nel menu.

Tasto R in impianti telefonici interni

Avendo collegato il telefono ad un impianto telefonico interno, il tasto  consente di accedere a tutte le altre funzioni disponibili, come ad es. trasferimento di chiamata e funzione di richiamata automatica. Si prega di consultare le istruzioni per l'uso del proprio impianto telefonico interno per individuare il tempo flash da impostare al fine di poter usufruire di queste funzioni. Il rivenditore autorizzato è in grado di indicare se il tele-

Impianti tel. interni / Servizi aggiuntivi

fono acquistato funzionerà senza alcun problema nel proprio impianto telefonico interno. Il tempo flash è impostato tramite menu. A pagina 71 è indicata la posizione da scorrere nel menu.

Pausa di selezione

In presenza di impianti telefonici interni è necessario preselezionare un numero di accesso alla rete esterna per ottenere un segnale di linea libera prima di poter compiere una telefonata. Alcuni impianti telefonici interni di vecchia data richiedono del tempo prima di trasmettere il segnale di libero. Per questi impianti telefonici interni è possibile inserire una pausa di selezione dopo il numero di accesso alla linea esterna in modo da poter proseguire con la selezione del numero senza dover attendere il segnale di libero. La pausa di selezione è inserita premendo il tasto  e tenendolo premuto per 3 sec.

Dopo il numero di accesso alla rete esterna si procede, trascorso un determinato intervallo di tempo, con la selezione del numero di chiamata vero e proprio.



La pausa di selezione è memorizzabile anche in sede di immissione di numeri di chiamata nella rubrica telefonica.

Visualizzazione del numero di chiamata (CLIP¹)



La visualizzazione del numero di chiamata è un servizio aggiuntivo offerto dal proprio gestore di rete telefonica. Si consiglia di rivolgersi al proprio gestore di rete telefonica per ricevere ulteriori informazioni a riguardo.

A condizione che il collegamento telefonico disponga di questa funzione, l'apparecchio visualizza il numero telefonico del chiamante non appena il telefono squilla. Nel caso in cui il chiamante abbia soppresso la trasmissione del proprio numero di chiamata, appare un'apposita indicazione. Se il numero di chiamata non è visualizzabile, questo non sarà memorizzato nell'elenco chiamate.

Segreteria telefonica integrata nella rete telefonica

Sono numerosi i gestori di rete telefonica che offrono come servizio aggiuntivo una segreteria telefonica integrata nella stessa rete. Se il proprio gestore di rete telefonica mette a disposizione una segreteria telefonica all'interno della propria rete telefonica, un simbolo informa sulla presenza di nuovi messaggi (VMWI²). Questa funzione è disponibile solo nel caso di abilitazione al servizio da parte del gestore di rete telefonica. Per maggiori dettagli a riguardo, rivolgersi al proprio gestore di rete telefonica.

¹ CLIP: Calling Line Identification Presentation = Visualizzazione del numero telefonico del chiamante.

² VMWI: Visual Message Waiting Indication = Segnalazione ottica di nuovi messaggi.

In presenza di problemi

12 In presenza di problemi

Linea di assistenza

In presenza di problemi con il telefono, seguire le indicazioni riportate qui di seguito. In caso di problemi tecnici è possibile rivolgersi alla linea diretta d'assistenza chiamando al numero 0900 00 1675 valido per la Svizzera (spese da rete Swisscom alla data di stampa: CHF 2.60 / min). In caso di reclami entro il periodo di garanzia, rivolgersi al rivenditore autorizzato. Il periodo di garanzia ricopre 2 anni.

Domande e risposte

Domande	Risposte
Non è possibile condurre una chiamata telefonica	<ul style="list-style-type: none">- Il telefono non è collegato correttamente oppure presenta un guasto. Utilizzare esclusivamente il cavo di collegamento telefonico fornito.- Provare con un altro telefono se l'allacciamento telefonico in questione è funzionante.- L'alimentatore di rete non è inserito oppure si è in presenza di una caduta di tensione totale.- Le batterie ricaricabili sono scariche o difettose.- La distanza dalla stazione base è troppo grande.- Procedura di selezione non impostata correttamente ➤ pagina 71.
Non è possibile collegarsi alla stazione base	<ul style="list-style-type: none">- Verificare se la registrazione alla stazione base è stata eseguita con il codice PIN corretto ➤ pagina 71.
Collegamento disturbato, interrotto	<ul style="list-style-type: none">- La distanza dalla stazione base è troppo grande.- Luogo di installazione della stazione base errato.
Il sistema non reagisce più	<ul style="list-style-type: none">- Ripristinare la configurazione iniziale per tutte le funzioni ➤ pagina 71.- Estrarre brevemente l'alimentatore di rete dalla presa di corrente.

In presenza di problemi

Le batterie ricaricabili si scaricano piuttosto subito

- Le batterie ricaricabili sono scariche o difettose.
- Riporre l'unità portatile correttamente nella stazione base. Pulire le superfici di contatto su unità portatile e stazione base con un panno morbido e asciutto.
- Posizionare l'unità portatile per la durata di 16 ore nella stazione base.

La visualizzazione del numero di chiamata (CLIP) non funziona

- La visualizzazione del numero di chiamata è un servizio addizionale offerto dal proprio gestore di rete telefonica. Per maggiori dettagli a riguardo, rivolgersi al proprio gestore di rete telefonica.
- Il chiamante ha disattivato la trasmissione del proprio numero di chiamata.

13 Specifiche tecniche

Specifiche tecniche

Caratteristica	Valore
Standard	DECT ¹ -GAP ²
Alimentazione elettrica (stazione base)	Ingresso: 230 V, 50 Hz Uscita: 7,5 V, 300 mA
Alimentazione elettrica (stazione di carica)	Ingresso: 230 V, 50 Hz Uscita: 7,5 V, 100 mA
Portata	Esterno: ca. 300 m Interno: ca. 50 m
Durata di stand-by	fino a 100 ore
Max. durata di conversazione	fino a 10 ore
Accumulatori ricaricabili	2 x AAA NiMH 1,2 V
Procedura di selezione	Selezione a toni Selezione a impulsi
Funzione flash	100 ms, 300 ms, 600 ms

Dichiarazione di conformità

Questo apparecchio risponde a quanto disposto dalla Direttiva UE 1999/5/CE concernente le apparecchiature radio, le apparecchiature terminali di telecomunicazioni e il reciproco riconoscimento della loro conformità. La conformità con la Direttiva di cui sopra viene confermata dal marchio CE applicato sull'apparecchio.

Per la dichiarazione di conformità completa si prega di voler usufruire del servizio gratuito di download dal nostro sito Internet www.switel.com.



¹ **DECT**: Digital Enhanced Cordless Telecommunication = Standard per telefoni senza cavo.

² **GAP**: Generic Access Profile = Standard per l'interazione di unità portatili e stazioni base di altri costruttori.

Consigli per la cura / Garanzia

14 Consigli per la cura / Garanzia

Consigli per la cura

- Pulire le superfici degli apparecchi con un panno morbido e antipelucchi.
- Non utilizzare mai detersivi o solventi.

Garanzia

Gli apparecchi SWITEL sono costruiti e collaudati in osservanza dei processi di produzione più moderni. L'impiego di materiali selezionati e tecnologie altamente sviluppate sono garanti di una perfetta funzionalità e lunga durata in vita. La garanzia non viene considerata esecutiva qualora la causa del malfunzionamento dell'apparecchio sia riconducibile al gestore della rete telefonica oppure se questa è da attribuirsi ad un impianto telefonico interno interposto. La garanzia non si estende a batterie, accumulatori o pacchi batteria utilizzati all'interno degli apparecchi. Il periodo di garanzia ricopre 24 mesi a partire dalla data di acquisto.

Entro il periodo di garanzia si procederà all'eliminazione gratuita di tutti i guasti dovuti a difetti di materiale o produzione. Il diritto di garanzia cessa in caso di interventi da parte dell'acquirente o di terzi. Danni derivanti da un impiego o esercizio non conforme agli usi previsti, a naturale usura, a errato montaggio o errata conservazione, a collegamento o installazione impropri, dovuti a forza maggiore o ad altri influssi esterni non sono coperti da garanzia. In qualità di produttore ci riserviamo il diritto, in caso di reclami, di riparare o sostituire le parti difettose o di rimpiazzare l'apparecchio. Parti o apparecchi sostituiti passano di nostra proprietà. Sono esclusi diritti di risarcimento per danni qualora non siano dovuti a intenzione o colpa grave del costruttore.

Nel caso in cui il presente apparecchio dovesse ciò nonostante presentare un difetto durante il periodo di garanzia, si prega di rivolgersi esclusivamente al negozio di rivendita dell'apparecchio SWITEL assieme al relativo scontrino di acquisto. In base alle presenti disposizioni, tutti i diritti di garanzia dovranno essere fatti valere esclusivamente nei confronti del rivenditore autorizzato. Decorso il termine di due anni dalla data di acquisto e consegna dei nostri prodotti non sarà più possibile fare valere alcun diritto di garanzia.

15 Indice alfabetico

A

Accettazione di chiamata, 64, 74
Agganciare il ricevitore, 74
Ampliamento, 78

B

Blocco di chiamata, 79
Blocco tastiera, 77

C

Cancellare, 73, 74
Caricare, 64
Cercare, 77
Chiamata d'emergenza, 79
Chiamata in attesa, 76
Chiamate a conferenza, 76
Chiamate interne, 75
CLIP, 80
Compiere telefonate, 74
Concludere una chiamata, 74
Consigli per la cura, 84
Contenuto della confezione, 61
Creare, 68

D

Data, 64
Deselezione, 78
Dichiarazione di conformità, 83
Display, 67
Domande e risposte, 81
Durata di conversazione, 76

E

Elementi di comando, 65
Elenco chiamate, 73
Eliminazione di guasti, 81
Esercizio, 66

F

Funzione di richiamata, 75
Funzione sorveglianza-bebé, 79
Funzione vivavoce, 77
Funzioni, 79

G

Garanzia, 84

I

Immettere un nome, 72
Immettere un testo, 72
Impianti telefonici interni, 79
Indicazioni di sicurezza, 60
Inserire gli accumulatori, 62

L

Linea di assistenza, 81
Lingua di display, 64

M

Memorizzare, 73
Menu principale, 69
Messa in funzione, 61
Modalità di stand-by, 67
Modalità ECO, 64
Modi di scrittura, 66
Modificare, 72
Montaggio a parete, 63

O

Ora, 64

P

Paging, 77
Pausa di selezione, 80
Problemi, 81
Procedura di selezione, 79

Indice alfabetico

R

- Riduzione delle radiazioni, 64
- Ripetizione di chiamata, 75
- Riscontro, 76
- Rubrica telefonica, 72, 75

S

- Salvare, 68
- Segnale di chiamata, 77
- Segreteria telefonica
 - integrata nella rete telefonica, 80
- Selezionare, 75
- Selezione, 78
- Servizi addizionali, 79
- Silenziamento, 77
- Silenziamento del microfono, 77
- Simboli, 67
- Simboli di display, 67
- Specifiche tecniche, 83
- Stato di carica degli accumulatori, 64
- Stazione base, 78
- Struttura del menu, 69
- Sveglia, 79

T

- Tasto R, 79
- Trasferimento di chiamata, 76

U

- Unità base, 62
- Unità portatile, 78

V

- Visualizzazione del
 - numero di chiamata, 73, 80
- VMWI, 80
- Voci della rubrica telefonica, 68, 72
- Volume del ricevitore, 76

Contents

1	Safety Information	88
2	Preparing the Telephone	89
3	Operating Elements	93
4	Preliminary Information	94
5	Menu Structure	97
6	Phone Book	100
7	Calls List	101
8	Telephoning	102
9	Extending the Telephone System	106
10	Special Functions	107
11	PBX / Supplementary Services	107
12	In Case of Problems	108
13	Technical Properties	110
14	Maintenance / Guarantee	111
15	Index	112

Safety Information

1 Safety Information

Please read this operating instruction manual thoroughly.

Intended use

The telephone is suitable for telephoning within a public telephone network system. Any other use is considered unintended use. Unauthorised modification or reconstruction is not permitted. Under no circumstances open the device or complete any repair work yourself.

Installation location

Prevent excessive exposure to smoke, dust, vibration, chemicals, moisture, heat and direct sunlight.

Do not use the telephone in potentially explosive areas.

Power adapter plug



Attention: Only use the power adapter plug supplied because other power supplies could damage the telephone. Ensure access to the power adapter plug is not obstructed by furniture or such.

Rechargeable batteries



Attention: Never throw batteries into a fire. Only use batteries of the same type. Pay attention to correct polarity. Incorrect polarity of the batteries presents a risk of explosion during charging.

Power failure

The telephone cannot be used to make calls in the event of a power failure. Always keep a wired telephone which operates without an external power supply available in case of emergency situations.

Medical equipment



Attention: Never use the telephone in the vicinity of medical equipment. Effects on such equipment cannot be fully ruled out.

Hearing aid compatible

The telephone is compatible with most popular hearing aids on the market. However, it cannot be guaranteed that all hearing aids will work perfectly.

DECT¹ telephones can cause an unpleasant humming sound in hearing aids.

¹ DECT: Digital Enhanced Cordless Telecommunication = Standard for cordless telephones.

Preparing the Telephone

Disposal

In order to dispose of your device, take it to a collection point provided by your local public waste authorities (e.g. recycling centre). According to laws on the disposal of electronic and electrical devices, owners are obliged to dispose of old **electronic and electrical devices** in a separate waste container.

The adjacent symbol indicates that the device must not be disposed of in normal domestic waste!

Risks to health and the environment from batteries!

Never open, damage or swallow batteries or allow them to pollute the environment. They could contain toxic and ecologically harmful heavy metals. You are legally obliged to dispose of power packs and batteries at the point of sale or in the corresponding containers provided at collection points by local public waste authorities. Disposal is free of charge. The above symbols indicate that the batteries must not be disposed of in domestic waste and that they must be disposed of at an authorised collection point.

Packaging materials must be disposed of according to local regulations.



2 Preparing the Telephone

Safety information



Attention: It is essential to read the Safety Information in Chapter 1 before starting up.

Checking the package contents

The package contains:

Content	Model DC68x ¹			
	681	682	683	684
Base station with power adapter plug	1	1	1	1
Charging station with power adapter plug	-	1	2	3
Handset	1	2	3	4
Telephone connection line	1	1	1	1
Batteries	2	4	6	8
Operating instructions	1	1	1	1

¹ Visit www.switel.com to find out whether the telephone/telephone set is already available.

Preparing the Telephone

Connecting the base station



Attention: Position the base station at least 1 m away from other electronic devices, otherwise there is a risk of mutual disturbance.

Connect the base station as illustrated in the diagram. For reasons of safety, only use the power adapter plug and telephone connection line supplied.

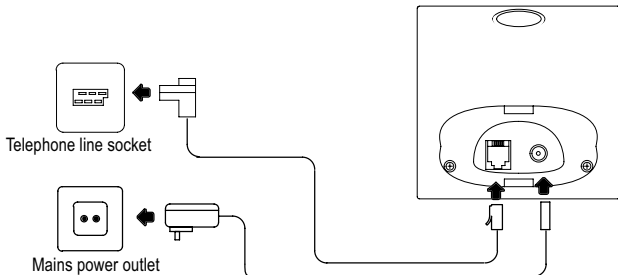

For the base station, use the power adapter plug labelled with No. SSA-5W-09 EU 075030F and output data 7.5 V, 300 mA.

Inserting the batteries

Insert the batteries in the open battery compartment. Only use batteries of the type AAA NiMH 1.2 V. Pay attention to correct polarity. Close the battery compartment cover.

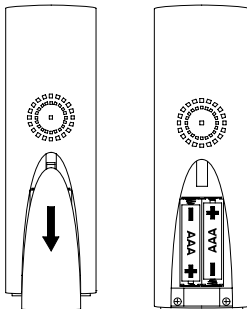

Preparing the Telephone

Wall installation

The telephone can also be installed on a wall. You require two screws in order to fix the telephone on a wall.



Warning: Ensure that there are no lines (cables or pipes etc.) under the surface of the wall where you want to drill the holes.

Drill two holes 55 mm apart and horizontal to each other and insert the screws leaving approx. 5 mm projecting from the wall. Remove the base station's desk support and turn it 180°. Then insert the desk support at the attachment points provided until it audibly snaps into place. Hook the base station support on the screws protruding from the wall and slide it down a little.

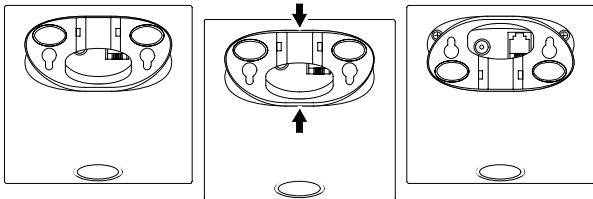

Preparing the Telephone

Charging the batteries



Before the handset is used for the first time, insert it in the base/charging station for **at least 16 hours**.

When the handset is properly inserted in the base station / charging station, you will hear an acoustic signal. The handset warms up during the charging process. This is normal and does not represent a risk. Do not charge the handset with charging units from other manufacturers. The current **battery charge status** is indicated in the display:



Full



Half empty



Low



Empty

Setting the display language

Select a language (cf. "Menu Structure"):

 > HS SETUP > LANGUAGE >...

There are 13 languages available for selection.

Setting the time and date on the handset

The time and date are set via the menu. Refer to Page 97 for the sequence of menu option selections.

Automatic answering

If this function is activated, an incoming call is taken when the handset is removed from the base station. The automatic answering function is activated and deactivated using the menu. Refer to Page 98 for the sequence of menu option selections.

Private branch exchanges

The information on Page 107 explains how to install your telephone in a private branch exchange.

Low-radiation operation (ECO mode)

The level of radiation is considerably lower than that of standard DECT cordless telephones when in Standby mode when the handset is in the base station.

In talk mode, radiation is reduced (depending on the distance between the handset and base station).



Operating Elements

3 Operating Elements

The buttons in this operating manual are subsequently depicted with a uniform contour. Therefore, slight deviations in the appearance of the symbols on the telephone buttons compared to those depicted here are possible.

Handset

- 1 Earpiece
- 2 LC display
- 3 Scroll up / Phone book
- 4 Delete / Redialling
- 5 On-hook button
- 6 Scroll down / Call list
- 7 Digit keys
- 8 # button / Ringing tone off
- 9 Microphone
- 10 * button / Key lock
- 11 Call button / Handsfree
- 12 Menu / OK button
- 13 LED

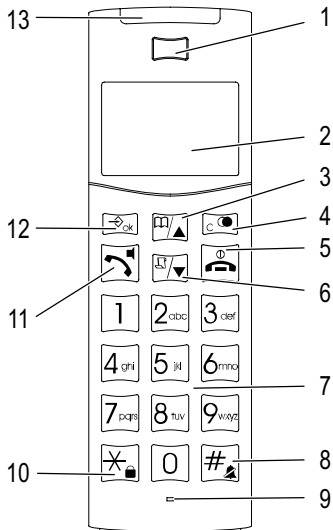

Preliminary Information

Base station

- 1 Paging button
- 2 Charging LED
- 3 Charging contacts

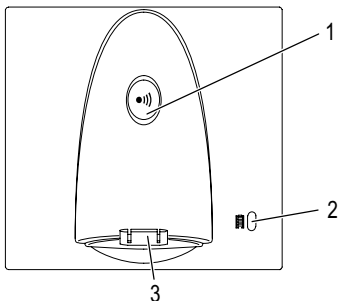

4 Preliminary Information













This chapter provides basic information on using the operating instruction manual and the telephone.

Description of operating sequences in the manual

Display	Description
	Displays the contour of buttons
	Press the button depicted briefly
2 sec.	Press the button depicted for 2 seconds
	Enter digits or letters
	Handset rings
	Remove the handset from the base station
	Place the handset in the base station
	Depicts text in the display
	Depicts icons in the display

Preliminary Information

Icons and texts in the handset display

Icon	Description
	On: Indicates the battery charge status. Off: The batteries must be charged. Run-through segments: The batteries are being charged; ☞ Page 92.
	A call is currently being made; ☞ Page 102.
	You have opened the menu; ☞ Page 97.
	You have opened the phone book; ☞ Page 100.
	You have opened the call list. New calls have been registered in the call list; ☞ Page 101.
	The ringing tone has been switched off; ☞ Page 104.
	The microphone is deactivated (muted); ☞ Page 105.
	The handsfree facility is activated; ☞ Page 104.
	The key lock function is activated; ☞ Page 105.
	The alarm clock is switched on; ☞ Page 97.
	Answering machine provided in the telephone network. VMWI ¹ - Supplementary service offered by telephone network providers; ☞ Page 108.
	The connection to the base station is good.

Standby mode











All descriptions in this operating manual assume that the handset is in Standby mode. This is the case when you are not talking on the phone and if a menu is not open. Press the , several times if necessary, to activate Standby mode.

¹ **VMWI: Visual Message Waiting Indication** = Visual indicator that new messages have been recorded.

Preliminary Information

Navigating in the menu

All the functions can be accessed via the various menus. Refer to Menu Structure;  Page 97 for information on how to access each respective function.









	Open the main menu
	Select the required submenu
	Open the submenu
	Select the required function
	Open the function
	Select the required setting
	Use the digit keys to enter numbers or letters
	Confirm the input
	Move one level back
	Interrupt the programming and saving processes and return to Standby mode



Every process is automatically cancelled if there is no input within 20 seconds.





Creating phone book entries - example

The way in which to navigate through the menus and select settings is explained by means of the example **Creating phone book entries**. Proceed as in this example for all the settings.





	Open the main menu
 PHONEBOOK 	Open the phone book
 ADD 	Select the submenu and confirm it
 	Enter the name (max. 12 characters) and confirm it
 	Enter the phone number (max. 20 digits) and confirm it

5 Menu Structure



Main menu

Press the  button to open the main menu. Then use the  /  buttons to select an entry and confirm it by pressing the  button. Further information on the menu and operation:  Chapter 4.

PHONEBOOK

ADD	ENTER NAME  ¹	NUMBER 
EDIT	ENTER NAME 	NUMBER 
DELETE		
DELETE ALL	CONFIRM?	
MUSIC GROUP	OFF, 1 - 12	
SPEED DIAL	ADD	HOT KEY 1 - 9
	DELETE	HOT KEY 1 - 9
MEMORY STATUS		



CLOCK/ALARM

DATE & TIME		
SET ALARM	ON ONCE	ON 
		OFF
	ON DAILY	ON 
		OFF

¹ Letters are also imprinted on the digit keys. Letters, digits and special characters are entered by pressing the relevant key the respective number of times.







Menu Structure

HS SETUP

HANDSET TONE	RING VOLUME	VOLUME
	RING MELODY	MELODY 1-12
	INTERCOM	MELODY 1-12
	KEY TONE	ON/OFF
	LOW BATT	ON/OFF
	RANGE	ON/OFF
Boost	ON / AUTO / OFF	
CONTRAST	01 - 06	
HANDSET NAME		
AUTO ANSWER	ON/OFF	
LANGUAGE		
BABY CALL	ENTER NUMBER	
	BABYCALL ON/OFF	ON/OFF

Menu Structure

BS SETUP

VMWI OFF? ¹	CONFIRM?	
REGISTER	BASE 1 - 4	PIN? ² 
SEL BASE	BASE 1 - 4 / AUTO	
ADVANCE SET		
PIN? 	DIAL MODE	TONE/PULSE
	RECALL TIME	100 MS / 300 MS / 600 MS
	AREA CODE	
	PREFIX	
	CALL BARRING	OPTION 1 - 4 ENTER NUMBER 
	SOS NUMBER	OPTION 1 - 4 ENTER NUMBER 
	UNREGISTER	HANDSET X
	CHANGE PIN	PIN? 
	DEFAULT	CONFIRM?

¹ **VMWI: Visual Message Waiting Indication** = Visual indicator that new messages have been recorded.

² The default PIN code is "0000".

Phone Book

6 Phone Book

You can use the phone book to store up to 60 phone numbers together with the associated names.

- Always enter the area access code with the phone numbers so that incoming local calls can also be assigned to a phone book entry.
- When the memory capacity is used up, the message **MEMORY FULL** appears when an attempt is made to store another number. To create space, an existing entry must first be deleted.
- The phone book entries are arranged alphabetically.

Entering names

Letters are also imprinted on the digit keys. Letters, digits and special characters are entered by pressing the relevant key the respective number of times.

	Enter a space
	Enter a special character
	Delete characters
	Move the cursor



To enter the same letter twice, press the button to enter the letter. Wait until the cursor skips one position forwards. Enter the letter again.

Creating phone book entries

	Open the phone book
ADD	Select the submenu and confirm it
	Enter the name (max. 12 characters) and confirm it
	Enter the phone number (max. 20 digits) and confirm it

Editing phone book entries

	Open the phone book
	Select an entry and confirm it
EDIT	Select the submenu and confirm it
	Change the name and confirm it
	Change the phone number and confirm it

Deleting phone book entries

Deleting an entry

	Open the phone book
/ / ,	Select an entry and confirm it
/ / , DELETE ,	Select the submenu and confirm it

Deleting all entries

	Open the phone book
, / / , DELETE ALL ,	Select the submenu and confirm it
CONFIRM? , or	Confirm the deleting process or cancel it

7 Calls List

A total of 50 phone numbers are stored in a call list.



The caller number display (**CLIP**¹) is a supplementary service offered by your telephone network provider. The caller's number appears in the display if the service is offered by your telephone network provider. Contact your network provider for further information.

Displaying numbers in the call list

, /	Open the call list and select an entry
------	----------------------------------------

Storing a phone number in the call list in the phone book

A phone number in the call list can be stored in the phone book directly.







, /	Open the call list and select an entry
	Open the menu
/	
SAVE NUMBER ,	Select the submenu and confirm it
,	Enter the name (max. 12 characters) and confirm it
,	Change the phone number and confirm it

¹ **CLIP**: Calling Line Identification Presentation = Displays the caller's phone number.









Telephoning

Deleting phone numbers from the call log

Deleting individual phone numbers

 /  / 	Open the call list and select an entry
	Open the menu
 /  , DELETE 	Select the submenu and confirm it

Deleting all phone numbers

	Open the call list
	Open the menu
 ,  /  ,	
DELETE ALL 	Select the submenu and confirm it
CONFIRM?  or 	Confirm the deleting process or cancel it

8 Telephoning



Taking a call

 , 	Take the call
-----------------------------------------------------------------------------------------------------------------------------------------------------------------------	---------------

Ending a call

	End the call
-----------------------------------------------------------------------------------	--------------

Making a call





	Enter the phone number (max. 32 digits)
	Delete the last digit if incorrect
	Dial the phone number



It is also possible to press the Call button  first to obtain the dialling tone for an outside line. The digits then entered are dialled immediately. It is not possible to correct wrong digits individually using this dialling procedure.

Redialling

The telephone stores the last 20 numbers dialled in a redialling list.





 ,  / 	Open the redialling list and select an entry
 	Dial the number

Editing phone numbers in the redialling list is identical to editing phone numbers in the call list;  Chapter 7.

Telephoning





Calling back calls received

Your telephone stores 50 phone numbers in a call list.

  / 	Open the call list and select an entry
 	Dial the number

Dialling numbers from the phone book







Phone numbers must have been stored in the phone book for this function;  Page 100.

  / 	Open the phone book and select an entry
 	Dial the number









Internal calls¹

Making internal calls

There must be two or more handsets (HS1, HS2, ...) registered on your base station in order to make internal calls free of charge.

 INTERCOM 	Initiate internal call
 /  	Dial the number of the internal phone required
HS2: 	Internal call is taken on the other handset
HS1 / HS2: 	End the internal call













Forwarding external calls internally

  / 	
INTERCOM 	During the external call
 /  	Dial the internal call number
HS2: 	Internal call is taken on the other handset
HS1: 	Forward the call

¹ Internal calls are only possible when at least two handsets are registered in the system;  "Checking the contents of the package" on Page 89.













Telephoning

Holding a call / brokering

 ,  / 	
INTERCOM , 	During the external call
 /  , 	Dial the internal call number
HS2: 	Internal call is taken on the other handset
 ,  / 	
SWITCHING , 	Switch to other caller



Making conference calls

An external call can be transferred to another internal handset for a conference call.

 ,  / 	
INTERCOM , 	During the external call
 /  , 	Dial the internal call number
HS2: 	Internal call is taken on the other handset
 ,  / 	
CONFERENCE , 	Start the conference call
HS1 / HS2: 	End the conference

Setting the receiver volume

The volume can be adjusted to one of 5 levels during a call.





 / 	Select the required volume
-----------------------------------------------------------------------------------------------------------------------------------------------------------------------	----------------------------

Displaying the duration of a call

The duration of a call is displayed in hours, minutes and seconds during the call.



Switching the ringing tone off

The handset's ringing tone can be switched off.

3 sec.  	Switch off the ringing tone
3 sec.  	Switch on the ringing tone

Handsfree

This function is used to listen to the caller via the loudspeaker.

	Activate handsfree talking
	Deactivate handsfree talking

Telephoning

Muting the microphone in the handset

The microphone in the handset can be activated and deactivated during a telephone conversation.

 **MUTE**  Deactivate the microphone (muting on)

 **UNMUTE**  Activate the microphone

Key lock

The key lock feature prevents functions assigned to buttons being activated accidentally.

3 sec.  Activate the key lock function



Incoming calls can still be taken in the normal way even when the key lock function is activated.

3 sec.  Deactivate the key lock function

Searching for the handset (Paging)

If you have mislaid your handset, you can sound a paging tone to find it.

Base station   Start the paging tone

 or  Stop the paging tone

Extending the Telephone System

9 Extending the Telephone System

The internationally approved **GAP**¹ regulates the compatibility of handsets and base stations from different manufacturers. As a result, it is possible to integrate SWITEL devices and devices from other manufacturers together in one telephone system. It is possible, however, that some functions are not available.

Multiple handsets

Up to 6 handsets can be registered on the base station.

Registering handsets

Before starting to register a handset, switch the base station to Registration mode.

10 sec.



Enable Registration mode

Now register the handset; Chapter 5.

Use your current PIN code to register it; Chapter 5.

The handset is automatically assigned an internal call number following registration.

The internal call number appears in the display.



To register handsets from other manufacturers, please refer to the operating manual supplied with them.

Deregistering handsets



A handset can only be deregistered from a base station by using another handset registered to the same base station.

Handsets are deregistered via the menu. Chapter 5 indicates the position in the menu.

Multiple base stations

You can increase the range of your handset by registering it on several base stations.

The handset can be registered on up to 4 different base stations simultaneously. Each base station requires its own telephone line socket. Connections can be used with the same call number or with different ones.



Calls in progress cannot be transferred from one base station to another.

¹ **GAP: Generic Access Profile** = Standard for the interoperation of handsets and base stations from different manufacturers.

10 Special Functions



Dialling mode

The telephone can be operated in analogue exchanges (PULSE mode) as well as new, digital exchanges (TONE/DTMF mode). The dialling mode is controlled via the menu. Refer to Page 99 for the sequence of menu option selections.

Alarm clock

The "Alarm clock" function can be used so that you are alerted by the handset at a specific time.

Baby call

Use this function to store a set phone number that will be dialled automatically when any button (except  and ) is pressed.

Call barring

The call barring function prevents call numbers, which you have programmed, from being dialled. You can define 4 numbers, each comprised of 8 digits, to be barred. Refer to Page 99 for the sequence of menu option selections.

SOS number (emergency call)

You can store up to 4 phone numbers which can still be dialled even when the call barring function is activated. Refer to Page 99 for the sequence of menu option selections.

11 PBX / Supplementary Services

R-button and supplementary services

Your telephone supports supplementary services provided by your telephone network provider, such as brokering, call waiting and conference facilities. These supplementary services can be used by implementing the  button. Please contact your telephone network provider regarding which Recall time must be set to use the supplementary services. Also contact your telephone network provider with regard to enabling supplementary services. The Recall time is set using the menu. Refer to Page 99 for the sequence of menu option selections.

R-button on private branch exchanges

If the telephone is connected to a private branch exchange, functions such as transferring calls and automatic call back can be used via the  button. Refer to the operating manual provided with your private branch exchange as to which Recall time must be set in order to use these functions. The sales outlet where you purchased the exchange can provide information as to whether the telephone will work properly with the exchange. The Recall time is set using the menu. Refer to Page 99 for the sequence of menu option selections.

In Case of Problems

Dialling pause

When using private branch exchanges, it is necessary to dial an access code to obtain the dialling tone for an outside line. When using some older private branch exchanges, it takes a little time before the dialling tone becomes audible. In the case of such private branch exchanges, a dialling pause can be inserted after the number for an outside line in order to continue dialling directly without having to wait for the dialling tone. The dialling pause is inserted by pressing and holding the  button for 3 seconds.

The actual phone number is dialled a certain time after the number for an outside line.



The dialling pause can also be entered with the phone numbers in the phone book.

Caller number display (CLIP¹)



The caller number display (CLIP) is a supplementary service offered by your telephone network provider. Contact your network provider for further information.

If this function is available with your telephone line, the number of the caller appears in the display when the phone rings. If the caller has suppressed transmission of his phone number, the corresponding message appears in the display. The phone number is not displayed and, as a result, is not stored in the call list.

Answering machine in the telephone network

An answering machine in the telephone network is a supplementary service offered by many telephone network providers. If your telephone network provider offers an answering machine in the telephone network for you, an icon on the display informs you of new messages received (VMWI²). This function can only be used when your telephone network provider actually offers the service. Contact your network provider for further information.

12 In Case of Problems

Service Hotline



Should problems arise with the telephone, please refer to the following information first. In the case of technical problems, you can contact our hotline service, Tel. 0900 00 1675 within Switzerland (Swisscom fees at time of going to print: CHF 2.60/min). In the case of claims under the terms of guarantee, please contact your sales outlet. There is a 2 year period of guarantee.

¹ **CLIP**: Calling Line Identification Presentation = Displays the caller's phone number.

² **VMWI**: Visual Message Waiting Indication = Visual indicator that new messages have been recorded.

In Case of Problems

Problems and solutions

Problems	Solutions
No telephone calls possible	<ul style="list-style-type: none">- The telephone is not connected properly or is defective. Only use the telephone connection cable supplied.- Test whether the telephone connection is in order by using another telephone.- The power adaptor plug is not plugged in or there is a complete power failure.- The rechargeable batteries are empty or defective.- The handset is too far from the base station.- The wrong dialling mode is set;  Page 99.
No connection to base station possible	<ul style="list-style-type: none">- Check that the handset has been registered on the base station with the correct PIN code;  Page 99.
Connection is disturbed or cut off	<ul style="list-style-type: none">- The handset is too far from the base station.- The base station is in an unsuitable location.
The system no longer responds	<ul style="list-style-type: none">- Reset all the functions to their default settings;  Page 99.- Disconnect the power adaptor plug briefly from the power socket.
The batteries are empty within a short time	<ul style="list-style-type: none">- The batteries are empty or defective.- Place the handset in the base station properly. Clean the contact surfaces on the handset and base station with a soft, dry cloth.- Place the handset in the base station for 16 hours.
The caller number display (CLIP) does not function	<ul style="list-style-type: none">- The caller number display (CLIP) is a supplementary service offered by your telephone network provider. Contact your network provider for further information.- The caller has suppressed the transmission of their phone number.

Technical Properties

13 Technical Properties

Technical data

Feature	Value
Standard	DECT ¹ -GAP ²
Power supply (base station)	Input: 230 V, 50 Hz Output: 7.5 V, 300 mA
Power supply (charging station)	Input: 230 V, 50 Hz Output: 7.5 V, 100 mA
Range	Outdoors: Approx. 300 m Indoors: Approx. 50 m
Standby time	Up to 100 h
Max. talk time	Up to 10 h
Rechargeable batteries	2 x AAA NiMH 1.2 V
Dialling mode	Tone dialling mode Pulse dialling mode
Recall (Flash) function	100 ms, 300 ms, 600 ms

Declaration of Conformity

This device fulfils the requirements stipulated in the EU directive: 1999/5/EC directive on radio equipment and telecommunications terminal equipment and the mutual recognition of their conformity. Conformity with the above mentioned directive is confirmed by the CE mark on the device.



To view the complete Declaration of Conformity, please refer to the free download available on our web site at www.switel.com.

¹ **DECT**: Digital Enhanced Cordless Telecommunication = Standard for cordless telephones.

² **GAP**: Generic Access Profile = Standard for the interoperation of handsets and base stations from different manufacturers.

14 Maintenance / Guarantee

Maintenance

- Clean the housing surfaces with a soft, fluff-free cloth.
- Do not use any cleaning agents or solvents.

Guarantee

SWITEL equipment is produced and tested according to the latest production methods. The implementation of carefully chosen materials and highly developed technologies ensure trouble-free functioning and a long service life. The terms of guarantee do not apply where the cause of equipment malfunction is the fault of the telephone network operator or any interposed private branch extension system. The terms of guarantee do not apply to the batteries or power packs used in the products. The period of guarantee is 24 months from the date of purchase.

All deficiencies related to material or manufacturing errors within the period of guarantee will be redressed free of charge. Rights to claims under the terms of guarantee are annulled following tampering by the purchaser or third parties. Damage caused as the result of improper handling or operation, normal wear and tear, incorrect positioning or storage, improper connection or installation or Acts of God and other external influences are excluded from the terms of guarantee. In the case of complaints, we reserve the right to repair defective parts, replace them or replace the entire device. Replaced parts or devices become our property. Rights to compensation in the case of damage are excluded where there is no evidence of intent or gross negligence by the manufacturer.

If your device does show signs of a defect within the period of guarantee, please contact the sales outlet where you purchased the SWITEL device, producing the purchase receipt as evidence. All claims under the terms of guarantee in accordance with this agreement can only be asserted at the sales outlet. No claims under the terms of guarantee can be asserted after a period of two years from the date of purchase and hand-over of the product.

Index

15 Index

A

- Alarm clock, 107
- Answering machine
 - in the telephone network, 108

B

- Baby call, 107
- Base station, 90, 106
- Battery charge status, 92
- Brokering, 104

C

- Call back, 103
- Call barring, 107
- Caller number display, 101, 108
- Calls list , 101
- Charging, 92
- CLIP, 108
- Conference calls, 104
- Creating, 96

D

- Date, 92
- Declaration of Conformity, 110
- Deleting, 101, 102
- Deregistration, 106
- Dialling, 103
- Dialling mode, 107
- Dialling pause, 108
- Display, 95
- Display icons, 95
- Display language, 92

E

- ECO mode, 92
- Editing, 100
- Emergency calls, 107
- Ending a call, 102
- Entering names, 100
- Entering text, 100
- Extending, 106

F

- Forwarding calls, 103
- Functions, 107

G

- Guarantee, 111

H

- Handset, 106
- Handsfree, 104
- Holding a call, 104

I

- Icons, 95
- Inserting the batteries, 90
- Internal calls, 103

K

- Key lock, 105

L

- Low-radiation, 92

M

Main menu, 97
Maintenance , 111
Making a call, 102
Menu structure, 97
Muting, 105
Muting button, 105

N

Notation, 94

O

Operating elements, 93
Operation, 94

P

Package contents, 89
Paging, 105
PBX systems, 107
Phone book, 100, 103
Phone book entries, 96, 100
Problems, 108
Problems and solutions, 109

R

R-button, 107
Receiver volume, 104
Redialling, 102
Registering, 106
Replace receiver, 102
Ringing tone, 104

S

Safety information, 88
Saving, 96
Searching for the handset, 105
Service-Hotline, 108
Standby mode, 95
Starting up, 89
Storing, 101
Supplementary services, 107

T

Taking a call, 92, 102
Talk time, 104
Technical data, 110
Telephoning, 102
Time, 92
Troubleshooting, 108

V

VMWI, 108

W

Wall installation, 91

Wichtiger Hinweis

Die Basisstation Ihres Telefons ist mit einem energieeffizienten Schaltnetzteil SSA-5W-09 EU 075030F (Input 230 V_{AC}, Output 7,5 V_{DC}, 300 mA) ausgestattet. Die Nulllast beträgt ca. 0,08 W. Die durchschnittliche Effizienz beträgt ca. 57,3 %. Die Leistungsaufnahme der Basisstation beträgt:

- im Betrieb (Bereitschaft/Gespräch): ca. 0,412 W / 0,487 W
- während der Ladung des Mobilteils: ca. 1,05 W

Die mit einem Telefonset gelieferte(n) Ladestation(en) ist/sind mit einem energieeffizienten Schaltnetzteil SSA-5W-09 EU 075010F (Input 230 V_{AC}, Output 7,5 V_{DC}, 100 mA) ausgestattet. Die Nulllast beträgt ca. 0,08 W.

Die durchschnittliche Effizienz beträgt ca. 36,8 %.

Die Leistungsaufnahme der Ladestation beträgt:

- ohne Mobilteil: ca. 0,08 W
- während der Ladung des Mobilteils: ca. 1,05 W

Note importante

La station de base de votre téléphone est équipée d'une alimentation à découpage SSA-5W-09 EU 075030F à haut rendement énergétique (entrée 230 V_{AC}, sortie 7,5 V_{DC}, 300 mA). Sans charge, le courant entrant s'élève à env. 0,08 W. Le rendement moyen est d'env. 57,3 %.

Puissance absorbée de la station de base :

- en mode de fonctionnement (disponible/conversation) : env. 0,412 W / 0,487 W
- pendant le chargement du combiné : env. 1,05 W

La(Les) station(s) de chargement livrée(s) avec un set de téléphone est (sont) équipée(s) d'une alimentation à découpage SSA-5W-09 EU 075010F à haut rendement énergétique (entrée 230 V_{AC}, sortie 7,5 V_{DC}, 100 mA).

Sans charge, le courant entrant s'élève à 0,08 W. Le rendement moyen est d'env. 36,8 %. Puissance absorbée de la station de chargement :

- sans le combiné : env. 0,08 W
- pendant le chargement du combiné : env. 1,05 W

Avvertimento importante

La stazione base del vostro telefono è dotata di un circuito di alimentazione rete ad efficienza energetica SSA-5W-09 EU 075030F (Input 230 V_{AC}, Output 7,5 V_{DC}, 300 mA). Il carico nullo è pari a circa 0,08 W.

L'efficienza media è pari a circa il 57,3 %.

La potenza assorbita dalla stazione base ammonta a:

- in servizio (stand-by/conversazione): ca. 0,412 W / 0,487 W
- durante la carica dell'unità mobile: ca. 1,05 W

La(e) stazione(i) di carica fornita(e) con un set telefonico è/sono dotata(e) di un circuito di alimentazione rete ad efficienza energetica SSA-5W-09 EU 075010F (Input 230 V_{AC}, Output 7,5 V_{DC}, 100 mA). Il carico nullo è pari a circa 0,08 W. L'efficienza media è pari a circa il 36,8 %.

La potenza assorbita dalla stazione di carica ammonta a:

- senza unità mobile: ca. 0,08 W
- durante la carica dell'unità mobile: ca. 1,05 W

Important note

Your phone's base station is supplied with an energy-efficient switching power supply SSA-5W-09 EU 075030F (Input 230 V_{AC}, Output 7.5 V_{DC}, 300 mA). The adaptor input power without load is approx. 0.08 W. The average efficiency is approx. 57.3 %. The electrical consumption of the base is:

- in operation mode (idle/call): approx. 0.412 W / 0.487 W
- during charging of the handset: approx. 1.05 W

The charger(s) delivered with a telephone set is/are supplied with an energy-efficient switching power supply SSA-5W-09 EU 075010F (Input 230 V_{AC}, Output 7.5 V_{DC}, 100 mA). The adaptor input power without load is approx. 0.08 W. The average efficiency is approx. 36.8 %.

The electrical consumption of the charger is:

- without handset charging: approx. 0.08 W
- during charging of the handset: approx. 1.05 W

SWITEL

Declaration of Conformity



Diese Anlage entspricht der europäischen R&TTE Richtlinie.
Für die komplette Konformitätserklärung nutzen Sie bitte den kostenlosen
Download von unserer Website www.switel.com.

Cet équipement est conforme à la directive européenne R&TTE.
Pour obtenir la déclaration de conformité intégrale, veuillez vous servir du
téléchargement gratuit de notre site Internet www.switel.com.

Quest'apparecchiatura è conforme alla direttiva europea R&TTE.
Per la dichiarazione di conformità completa si prega di voler usufruire del
servizio gratuito di download dal nostro sito Internet www.switel.com.

This equipment complies with the European R&TTE directive.
To view the complete Declaration of Conformity, please refer to the free
download available at our web site: www.switel.com.

Service Hotline

Bei technischen Problemen können Sie sich an unsere Service-Hotline unter
Tel. 0900 00 1675 innerhalb der Schweiz (Kosten Swisscom bei Drucklegung:
CHF 2.60/min) wenden.

S'il s'agit de problèmes techniques, vous pouvez vous adresser à notre
hotline de service en Suisse en appelant le numéro 0900 00 1675
(frais Swisscom à la date d'impression de ce manuel : CHF 2.60/min).

In caso di problemi tecnici è possibile rivolgersi alla nostra hotline di
assistenza tecnica chiamando al numero 0900 00 1675 valido per la Svizzera
(spese da rete Swisscom alla data di stampa: CHF 2.60 / min).

In the event of technical problems, you can contact our hotline service, Tel.
0900 00 1675 within Switzerland (cost via Swisscom at time of going to print:
CHF 2.60/min).