

# **SWITEL**

**COMMUNICATION PRODUCTS**

Schnurloses DECT-/GAP-Verstärker-Telefon mit XL-Tasten

Téléphone DECT/GAP sans fil, amplifié, avec touches XL

Telefono cordless con amplificatore DECT/GAP, tasti XL

Cordless DECT/GAP amplifier telephone with XL buttons



## **DC62x**

**Bedienungsanleitung**  
**Mode d'emploi**  
**Istruzioni per l'uso**  
**Operating Instructions**

**D**

**F**

**I**

**GB**

---

# ***SWITEL***

Bedienungsanleitung . . . . .	3
Mode d'emploi . . . . .	33
Istruzioni per l'uso . . . . .	63
Operating Instructions . . . . .	93
Declaration of Conformity . . . . .	124

# Inhaltsverzeichnis

---

1	Sicherheitshinweise . . . . .	4
2	Telefon in Betrieb nehmen . . . . .	5
3	Bedienelemente . . . . .	8
4	Einführende Informationen . . . . .	9
5	Menüstruktur . . . . .	12
6	Telefonbuch . . . . .	16
7	Anrufliste . . . . .	18
8	Telefonieren . . . . .	20
9	Erweitern des Telefonsystems . . . . .	23
10	Besondere Funktionen . . . . .	24
11	Nebenstellenanlagen / Zusatzdienste . . . . .	24
12	Falls es Probleme gibt . . . . .	25
13	Technische Eigenschaften . . . . .	27
14	Pflegehinweise / Garantie . . . . .	29
15	Stichwortverzeichnis . . . . .	30

# Sicherheitshinweise

---

## 1 Sicherheitshinweise

Lesen Sie diese Bedienungsanleitung sorgfältig durch.

### Bestimmungsgemäße Verwendung

Dieses Telefon ist geeignet zum Telefonieren innerhalb eines Telefonnetzes. Jede andere Verwendung gilt als nicht bestimmungsgemäß. Eigenmächtige Veränderungen oder Umbauten sind nicht zulässig. Öffnen Sie das Gerät in keinem Fall selbst und führen Sie keine eigenen Reparaturversuche durch.

### Aufstellungsort

Vermeiden Sie Belastungen durch Rauch, Staub, Erschütterungen, Chemikalien, Feuchtigkeit, Hitze oder direkte Sonneneinstrahlung.

Verwenden Sie das Mobilteil nicht in explosionsgefährdeten Bereichen.

### Netzteil



**Achtung:** Verwenden Sie nur das mitgelieferte Steckernetzteil, da andere Netzteile das Telefon beschädigen können. Sie dürfen den Zugang zum Steckernetzteil nicht durch Möbel oder andere Gegenstände versperren.

### Aufladbare Akkus



**Achtung:** Werfen Sie Akkus nicht ins Feuer. Verwenden Sie nur Akkus des gleichen Typs! Achten Sie auf die richtige Polung! Bei verkehrter Polung der Akkus besteht beim Aufladen Explosionsgefahr.

### Stromausfall

Bei Stromausfall kann mit diesem Telefon nicht telefoniert werden. Halten Sie für Notfälle ein schnurgebundenes Telefon bereit, welches ohne externe Stromversorgung arbeitet.

### Medizinische Geräte



**Achtung:** Benutzen Sie das Telefon nicht in der Nähe von medizinischen Geräten. Eine Beeinflussung kann nicht völlig ausgeschlossen werden.

### Hörgeräte-kompatibel

Das Telefon ist mit den meisten am Markt befindlichen Hörgeräten kompatibel. Eine einwandfreie Funktion mit jedem Hörgerät kann jedoch nicht garantiert werden.

DECT<sup>1</sup>-Telefone können in Hörgeräten einen unangenehmen Brummtönen verursachen.

<sup>1</sup> DECT: Digital Enhanced Cordless Telecommunication = Standard für kabellose Telefone.

# Telefon in Betrieb nehmen

## Entsorgung

Wollen Sie Ihr Gerät entsorgen, bringen Sie es zur Sammelstelle Ihres kommunalen Entsorgungsträgers (z. B. Wertstoffhof). Das nebenstehende Symbol bedeutet, dass Sie das Gerät auf keinen Fall in den Hausmüll werfen dürfen! Nach dem Elektro- und Elektronikgerätegesetz sind Besitzer von Altgeräten gesetzlich gehalten, alte **Elektro- und Elektronikgeräte** einer getrennten Abfallerfassung zuzuführen.



**Akkus** entsorgen Sie beim batterievertreibenden Handel sowie bei zuständigen Sammelstellen, die entsprechende Behälter bereitstellen.



**Verpackungsmaterialien** entsorgen Sie entsprechend den lokalen Vorschriften.

## 2 Telefon in Betrieb nehmen

### Sicherheitshinweise



**Achtung:** Lesen Sie vor der Inbetriebnahme unbedingt die Sicherheitshinweise in Kapitel 1.

### Verpackungsinhalt prüfen

Zum Lieferumfang gehören:

Inhalt	DC62x-Modell <sup>1</sup>			
	621	622	623	624
Basisstation mit Netzteil	1	1	1	1
Ladestation mit Netzteil	-	1	2	3
Mobilteil	1	2	3	4
Telefonanschlusskabel	1	1	1	1
Akkus	2	4	6	8
Bedienungsanleitung	1	1	1	1

### Basisstation anschließen



**Achtung:** Stellen Sie die Basisstation mit einem Mindestabstand von 1 m zu anderen elektronischen Geräten auf, da es sonst zu gegenseitigen Störungen kommen kann.

<sup>1</sup> Unter [www.switel.com](http://www.switel.com) erfahren Sie, ob dieses Telefon/Telefonset bereits erhältlich ist.

# Telefon in Betrieb nehmen

Schließen Sie die Basisstation wie auf der Skizze abgebildet an. Verwenden Sie aus Sicherheitsgründen nur das mitgelieferte Netzteil sowie das beigelegte Telefonanschlusskabel.

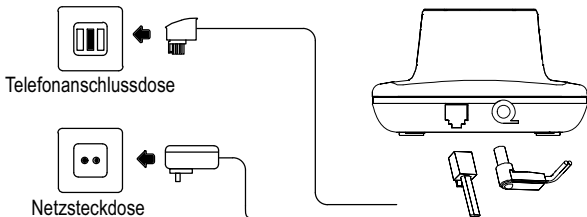

Verwenden Sie für die Basisstation das Netzteil mit der Nr. VD060025D (oder BD060025D) und den Ausgangsdaten 6 V, 250 mA.

## Ladestation anschließen<sup>1</sup>

Schließen Sie die Ladestation wie auf der Skizze abgebildet an. Verwenden Sie aus Sicherheitsgründen nur das mitgelieferte Netzteil.

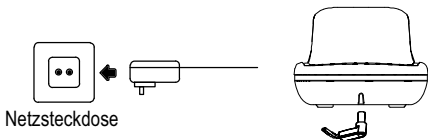

Verwenden Sie für die Ladestation das Netzteil mit der Nr. VD060015D (oder BD060015D) und den Ausgangsdaten 6 V, 150 mA.

## Akkus einlegen

Legen Sie die Akkus in das geöffnete Akkufach ein. Verwenden Sie nur Akkus des Typs AAA NiMH 1,2 V. Achten Sie auf die richtige Polung! Schließen Sie das Akkufach.

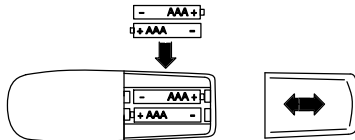

<sup>1</sup> Gilt nur für Telefonsets mit mindestens zwei Mobilteilen ☞ "Verpackungsinhalt prüfen" auf Seite 5.

# Telefon in Betrieb nehmen

## Akkus aufladen



Stellen Sie das Mobilteil bei der ersten Inbetriebnahme für **mindestens 16 Stunden** in die Basisstation / Ladestation.

[Haben Sie das Mobilteil richtig in die Basisstation / Ladestation gestellt, ertönt ein Hinweissignal.] [Haben Sie das Mobilteil richtig in die Basisstation / Ladestation gestellt, leuchtet die Ladekontrollleuchte.] Das Mobilteil erwärmt sich beim Laden. Dies ist normal und ungefährlich. Laden Sie das Mobilteil nicht mit fremden Aufladegeräten. Der aktuelle **Akkuladestatus** wird im Display angezeigt:



Voll



Halb



Schwach



Leer

## Displaysprache einstellen

Wählen Sie die entsprechende Sprache aus (siehe auch "Menü-Struktur"):

☞ > MOBILTEIL > SPRACHE >...

Es stehen die Sprachen Deutsch, Französisch, Italienisch und Englisch zur Verfügung.

## Datum und Uhrzeit des Mobilteils einstellen

Datum und Uhrzeit stellen Sie über das Menü ein. Auf Seite 13 finden Sie die Position im Menü.

## Automatische Anrufannahme

Haben Sie diese Funktion aktiviert, wird ein Anruf automatisch beim Herausnehmen des Mobilteils aus der Basisstation angenommen. Die automatische Anrufannahme wird über das Menü aktiviert oder deaktiviert. Auf Seite 14 finden Sie die Position im Menü.

## Nebenstellenanlagen

Auf Seite 24 erhalten Sie weitere Informationen, falls Sie Ihr Telefon an eine Nebenstellenanlage anschließen möchten.

## Strahlungsreduzierung (ECO-Mode)

Die Strahlung wird im Vergleich zu Standard-DECT-Schnurlostelefonen im Bereitschaftsmodus erheblich verringert, wenn das Mobilteil in der Basis steht.

Im Gesprächsmodus wird die Strahlung abhängig von der Entfernung des Mobilteils zur Basis verringert.



# Bedienelemente

## 3 Bedienelemente

Die Tasten Ihres Telefons werden in dieser Bedienungsanleitung nachfolgend mit vereinheitlichten umrandeten Symbolen dargestellt. Leichte Abweichungen der Tastensymbole Ihres Telefons gegenüber den hier verwendeten Tastensymbolen sind daher möglich.

### Mobilteil

- 1 Lautsprecher
- 2 LCD-Display
- 3 Menü-/OK-Taste
- 4 Schnellwahl Taste M2
- 5 Headsetanschluss
- 6 Lösch-/R-Taste
- 7 Freisprechtaste
- 8 Zifferntastenblock
- 9 #-Taste / Tastensperre
- 10 Mikrofon
- 11 Pausetaste
- 12 \*-Taste / Interngespräche
- 13 Gesprächs-/Auflegetaste
- 14 Pfeiltaste unten / Anrufliste
- 15 Schnellwahl Taste M1
- 16 Pfeiltaste oben / Wahlwiederholung
- 17 LED

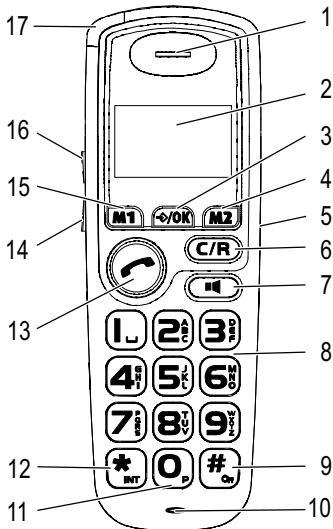

### Headsetanschluss

Auf der rechten Seite des Mobilteils finden Sie eine Anschlussmöglichkeit für ein Headset. Verwenden Sie ein Headset mit einem 2,5 mm Stereoklinkenstecker. Eine Funktionsgarantie kann nicht übernommen werden.



# Einführende Informationen

## Basisstation



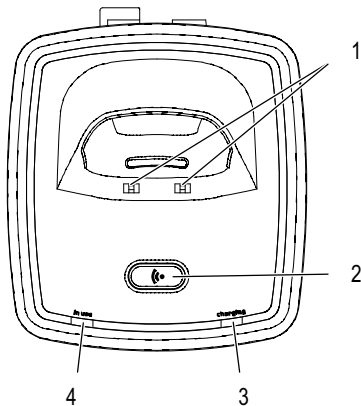



- 1 Ladekontakte
- 2 Paging-Taste
- 3 Lade-LED
- 4 Betriebszustand-LED





## 4 Einführende Informationen

In diesem Kapitel finden Sie grundlegende Informationen zur Handhabung der Bedienungsanleitung und des Telefons.









### Darstellungsweise in der Bedienungsanleitung

Darstellung	Beschreibung
	Darstellung von Tasten
	Abgebildete Taste kurz drücken
2 Sek. 	Abgebildete Taste 2 Sekunden drücken
	Nummern oder Buchstaben eingeben
	Mobilteil klingelt
	Mobilteil aus der Basisstation nehmen
	Mobilteil in die Basisstation stellen

# Einführende Informationen

	Darstellung von Display-Texten
	Darstellung von Display-Symbolen

## Symbole und Texte im Display des Mobilteils

Symbol	Beschreibung
	Konstant: Anzeige der Batteriekapazität. Blinkend: Laden Sie die Akkus. Durchlaufende Segmente: Die Akkus werden geladen ➞ Seite 7.
1	Interne Rufnummer des Mobilteils ➞ Seite 23.
12--59	Anzeige der Uhrzeit ➞ Seite 13.
	Sie führen ein Gespräch ➞ Seite 20.
	Sie befinden sich in der Anrufliste. Es sind neue Anrufe in der Anrufliste ➞ Seite 18.
	Der Tonruf ist ausgeschaltet ➞ Seite 13.
	Das Freisprechen ist aktiviert ➞ Seite 22.
	Die Tastensperre ist aktiviert ➞ Seite 22.
	Die Alarmfunktion ist eingeschaltet.
NEUE NACHRICHT	Anrufbeantworter im Telefonnetz. <b>VMWI</b> <sup>1</sup> - Zusatzdienst Ihres Netzbetreibers ➞ Seite 25.
	Die Verbindung zur Basisstation ist gut.

## Bereitschaftsmodus

Alle Beschreibungen in dieser Bedienungsanleitung gehen davon aus, dass sich das Mobilteil im Bereitschaftsmodus befindet. Das Mobilteil ist im Bereitschaftsmodus, wenn kein Gespräch geführt wird und kein Menü geöffnet ist. Drücken Sie ggf. die Taste  mehrfach, um in den Bereitschaftsmodus zu gelangen.













<sup>1</sup> **VMWI**: Visual Message Waiting Indication = Optische Anzeige neuer Nachrichten.

# Einführende Informationen

## Navigation im Menü

Alle Funktionen sind über unterschiedliche Menüs zu erreichen. Den Weg zur gewünschten Funktion entnehmen Sie der Menüstruktur

☞ Seite 12.









	Hauptmenü öffnen
 oder 	Gewünschtes Untermenü auswählen
	Untermenü öffnen
 oder 	Gewünschte Funktion auswählen
	Funktion öffnen
 oder 	Gewünschte Einstellung auswählen
	Über Tastenfeld Nummern oder Buchstaben eingeben
	Eingaben bestätigen
	Eine Ebene zurück
ggf. mehrfach 	Programmier- und Speichervorgänge abbrechen und in den Stand-by-Modus zurückkehren



Jeder Vorgang wird automatisch abgebrochen, wenn innerhalb von 15 Sekunden keine Eingabe erfolgt.

## Telefonbucheinträge erstellen - Beispiel





Wie Sie in den Menüs navigieren und Einstellungen vornehmen, ist hier anhand des Beispiels **Telefonbucheinträge erstellen** erklärt. Verfahren Sie bei allen Einstellungen wie in diesem Beispiel.

	Hauptmenü öffnen
TELEFONBUCH 	Telefonbuch öffnen
	Auswahl von Einträgen überspringen
NEUER EINTRAG 	Untermenü auswählen und bestätigen
 	Namen eingeben (max. 12 Stellen) und bestätigen
 	Rufnummer eingeben (max. 24 Ziffern) und bestätigen



# Menüstruktur





## 5 Menüstruktur



### Hauptmenü



In das Hauptmenü gelangen Sie, wenn Sie die Taste  drücken. Danach wählen Sie mit den Tasten  oder  einen Eintrag aus und bestätigen Sie Ihre Auswahl mit der Taste .

Weitere Informationen zum Menü und zur Bedienung  Kapitel 4.

TELEFONBUCH, / Eintrag auswählen,  überspringen

NEUER EINTRAG	NAME  <sup>1</sup>	NUMMER 
ÄNDERN	NAME 	NUMMER 
LÖSCHEN	BESTÄTIGEN?	
ALLE LÖSCH.	BESTÄTIGEN?	

ANRUFLISTE<sup>2</sup>, / Eintrag auswählen,  überspringen

SPEICHERN	NAME 	NUMMER 
LÖSCHEN	BESTÄTIGEN?	
ALLE LÖSCH.	BESTÄTIGEN?	

<sup>1</sup> Die Zifferntasten sind mit Buchstaben beschriftet. Durch mehrmaliges Drücken der entsprechenden Taste können Buchstaben, Ziffern und Sonderzeichen eingegeben werden.

<sup>2</sup> Für das Anzeigen und Speichern von Rufnummern in Anruflisten wird die Rufnummernanzeige (**CLIP**<sup>3</sup>) benötigt. Die Rufnummernanzeige ist ein Zusatzdienst Ihres Netzbetreibers. Fragen Sie Ihren Netzbetreiber nach weiteren Informationen. Weitere Informationen zur Rufnummernanzeige  Seite 18.

<sup>3</sup> **CLIP**: Calling Line Identification Presentation = Anzeige der Rufnummer eines Anrufers.

# Menüstruktur

WAHLWIEDERH., /↓ Eintrag auswählen, überspringen

SPEICHERN	NAME	NUMMER
LÖSCHEN	BESTÄTIGEN?	
ALLE LÖSCH.	BESTÄTIGEN?	



## ALARM

ALARM 1	AUS		
	AN	UHRZEIT	BESTÄTIGEN?
ALARM 2	AUS		
	AN	UHRZEIT	BESTÄTIGEN?

## MOBILTEIL

RUFTÖNE	RUFTON EXT.	MELODIE 1-10
	RUFTON INT.	MELODIE 1-10
LAUTSTÄRKE	LAUTSTÄRKE 1-5, AUS	
DATUM/ZEIT	DATUM/ZEIT EINSTELL.	DATUM  ↘
		↘ BESTÄTIGEN?
		UHRZEIT  ↘
		↘ BESTÄTIGEN?
	DATUM/ZEIT FORMAT	DATUM  ↘
		↘ TT/MM
		↘ MM/TT



# Menüstruktur

↙		UHRZEIT  ↘
		↘ 12 STD.
		↘ 24 STD.
HÖRVERSTÄRK.	AN	LEISE
		MITTEL
		LAUT
	AUTOMATISCH	
	AUS	
TASTENTON	AN/AUS	
DISPLAY KONTRAST	STUFE 1-8	
MT-NAME		
BELEUCHTUNGS EIN- STELLUNG	5-30 SEKUNDEN	
AUTO ANNAHME	AN/AUS	
SPRACHE <sup>1</sup>		
RÜCKSETZEN	BESTÄTIGEN?	



<sup>1</sup>Welche Sprachen zur Verfügung stehen siehe  Kapitel 2.

# Menüstruktur

## BASIS, PIN EINGEBEN 1

RUFTÖNE	MELODIE 1-5	
LAUTSTÄRKE	LAUTSTÄRKE 1-5, AUS	
PIN ÄNDERN <sup>1</sup>	NEUER PIN 	PIN BESTÄT. 
WAHLVERFAHR.	TONWAHL	
	PULSWAHL	
FLASH-ZEIT	KURZ	
	MITTEL	
	LANG	
VMWI <sup>2</sup>	VMWI OFF?	
RESET	BESTÄTIGEN?	

## AN-/ABMELDEN

ANMELDEN	PIN EINGEBEN 	
BASIS WÄHLEN	BASIS 1-4	
MOBILTEIL ABMELDEN	PIN EINGEBEN 	MOBILTEIL 1-4
BASIS ABMEL.	BASIS 1-4	

<sup>1</sup> Der PIN-Code ist werkseitig auf "0000" eingestellt.

<sup>2</sup> **VMWI**: Visual **M**essage **W**aiting **I**ndication = Optische Anzeige neuer Nachrichten.

# Telefonbuch

## 6 Telefonbuch

Im Telefonbuch können Sie 100 Rufnummern mit den dazugehörigen Namen speichern.

- Geben Sie bei allen Rufnummern immer die Vorwahl mit ein, damit auch eingehende Ortsgespräche einem Telefonbucheintrag zugeordnet werden können.
- Ist die Speicherkapazität erschöpft, zeigt das Display beim nächsten Speichern die Meldung . Um wieder Platz zu schaffen, müssen Sie zuerst einen anderen Eintrag löschen.
- Die Telefonbucheinträge sind alphabetisch geordnet.

### Namen eingeben

Die Zifferntasten sind mit Buchstaben beschriftet. Durch mehrmaliges Drücken der entsprechenden Taste können Buchstaben, Ziffern und Sonderzeichen eingegeben werden.

<input type="text" value="1"/>	Leerzeichen eingeben
<input type="text" value="C"/>	Löschen
<input type="text" value="▲"/> oder <input type="text" value="▼"/>	Cursor bewegen



Um den gleichen Buchstaben zweimal einzugeben, drücken Sie die entsprechende Taste. Warten Sie, bis der Cursor eine Stelle weitersprungen ist. Geben Sie den Buchstaben erneut ein.

### Telefonbucheinträge erstellen

<input type="text" value="↔"/>	Hauptmenü öffnen
<input type="text" value="TELEFONBUCH"/> <input type="text" value="↔"/>	Telefonbuch öffnen
<input type="text" value="↔"/>	Auswahl von Einträgen überspringen
<input type="text" value="NEUER EINTRAG"/> <input type="text" value="↔"/>	Untermenü auswählen und bestätigen
<input type="text" value="☰, ↔"/>	Namen eingeben (max. 12 Stellen) und bestätigen
<input type="text" value="☰, ↔"/>	Rufnummer eingeben (max. 24 Ziffern) und bestätigen



# Telefonbuch

## Telefonbucheinträge ändern

	Hauptmenü öffnen
TELEFONBUCH	Telefonbuch öffnen
oder ,	Eintrag auswählen, bestätigen
oder , <b>ÄNDERN</b>	Untermenü auswählen und bestätigen
,	Namen ändern und bestätigen
,	Rufnummer ändern und bestätigen

## Telefonbucheinträge löschen

### Einen Eintrag löschen

	Hauptmenü öffnen
TELEFONBUCH	Telefonbuch öffnen
oder ,	Eintrag auswählen, bestätigen
oder , <b>LÖSCHEN</b>	Untermenü auswählen und bestätigen
<b>BESTÄTIGEN?</b> oder <b>C</b>	Löschvorgang bestätigen oder abbrechen

### Alle Einträge löschen

	Hauptmenü öffnen
TELEFONBUCH	Telefonbuch öffnen
	Auswahl von Einträgen überspringen
oder , <b>ALLE LÖSCH.</b>	Untermenü auswählen und bestätigen
<b>BESTÄTIGEN?</b> oder <b>C</b>	Löschvorgang bestätigen oder abbrechen

# Anrufliste

## Direktwahl

Sie können jeweils 1 Rufnummer als Direktwahl auf den Tasten **M1** und **M2** speichern.

## Rufnummern als Direktwahl speichern

Geben Sie eine Nummer ein oder wählen Sie einen Eintrag aus dem Telefonbuch, der Wahlwiederholung oder der Anrufliste.

3 Sek. **M1** oder **M2**

Auswahl auf entsprechender Direktwahl-Taste gespeichert



Einträge auf Direktwahltasten können nicht gelöscht, sondern nur überschrieben werden.

## 7 Anrufliste

Insgesamt werden 20 Rufnummern in einer Anrufliste gespeichert.



Die Rufnummernanzeige (**CLIP**<sup>1</sup>) ist ein Zusatzdienst Ihres Netzbetreibers. Ihr Telefon zeigt die Rufnummern im Display, wenn Ihr Netzbetreiber diesen Service anbietet. Bitte fragen Sie Ihren Netzbetreiber nach weiteren Informationen.

Meldungen im Display:

UNBEKANNT	Die Rufnummer wurde nur teilweise oder fehlerhaft empfangen.
UNBEKANNT	Die Information der Rufnummer ist nicht verfügbar. Es könnte sich um ein internationales Gespräch handeln.
PRIVAT	Der Anrufer hat das Senden seiner Rufnummer unterdrückt.

## Rufnummern aus der Anrufliste anzeigen

, oder

Anrufliste öffnen und Eintrag auswählen











Drücken Sie die Taste ggf. mehrfach, um im Display zwischen den Anzeigen "Name", "Nummer" und "Eingangs-Uhrzeit/Datum" zu wechseln.

<sup>1</sup> **CLIP**: Calling Line Identification Presentation = Anzeige der Rufnummer eines Anrufers.

# Anrufliste

## Rufnummer aus der Anrufliste im Telefonbuch speichern

Eine Rufnummer kann direkt aus der Anrufliste im Telefonbuch gespeichert werden.









 ,  oder 	Anrufliste öffnen und Eintrag auswählen
	Menü öffnen
 oder  , <b>SPEICHERN</b> , 	Untermenü auswählen und bestätigen
 , 	Namen eingeben (max. 12 Stellen) und bestätigen
 , 	Rufnummer ändern und bestätigen









Sobald die Rufnummer im Telefonbuch mit einem Namen gespeichert wurde, erscheint in der Anrufliste der eingegebene Name.

## Rufnummern aus der Anrufliste löschen

Einzelne Rufnummer löschen

 ,  oder 	Anrufliste öffnen und Eintrag auswählen
	Menü öffnen
 oder  , <b>LÖSCHEN</b> , 	Untermenü auswählen und bestätigen
<b>BESTÄTIGEN?</b> ,  oder <b>C</b>	Löschvorgang bestätigen oder abbrechen

Alle Rufnummern löschen

	Anrufliste öffnen
	Menü öffnen
 oder  , <b>ALLE LÖSCH.</b> , 	Untermenü auswählen und bestätigen
<b>BESTÄTIGEN?</b> ,  oder <b>C</b>	Löschvorgang bestätigen oder abbrechen

# Telefonieren

## 8 Telefonieren

### Anruf annehmen

,  oder  Anruf annehmen

### Gespräch beenden

 Gespräch beenden

### Anrufen

 Rufnummer eingeben (max. 24 Ziffern)

 Bei Falscheingabe letzte Ziffer löschen



 oder  Rufnummer wählen



Sie können auch zuerst die Taste  drücken und erhalten damit das Freizeichen. Die eingegebenen Ziffern Ihrer gewünschten Rufnummer werden sofort gewählt. Eine Korrektur einzelner Ziffern der Rufnummer ist bei dieser Form des Gesprächsaufbaus nicht möglich.

### Wahlwiederholung

Ihr Telefon speichert die 10 zuletzt gewählten Rufnummern in einer Wahlwiederholungsliste.

,  oder  Wahlwiederholungsliste öffnen und Eintrag auswählen

 Verbindung herstellen

Das Bearbeiten von Rufnummern in einer Wahlwiederholungsliste ist identisch zur Bearbeitung von Rufnummern in der Anruferliste

 Kapitel 7.

### Eingegangene Anrufe zurückrufen

Ihr Telefon speichert 20 Rufnummern in einer Anrufliste.

,  oder  Anrufliste öffnen und Eintrag auswählen

 Verbindung herstellen

### Rufnummern aus dem Telefonbuch wählen

Sie müssen Rufnummern im Telefonbuch gespeichert haben

 Kapitel 6.

 Hauptmenü öffnen

TELEFONBUCH  Telefonbuch öffnen

 oder ,  Eintrag auswählen, Verbindung herstellen

# Telefonieren

## Direktwahl

Sie müssen Rufnummern als Direktwahlnummer gespeichert haben  Kapitel 5.

3 Sek. **M1** oder **M2** Direktwahl durchführen

## Intern telefonieren<sup>1</sup>

Interne Gespräche führen

Sie müssen zwei oder mehr Mobilteile (MT1, MT2, ...) an Ihrer Basisstation angemeldet haben, um interne kostenlose Gespräche führen zu können.

MT1: 3 Sek. **INT** Internes Telefonieren einleiten

z. B. **2<sup>ABC</sup>** Interne Rufnummer des gewünschten Mobilteils wählen

MT2:  Internes Gespräch am anderen Mobilteil annehmen

MT1 / MT2:  Internes Gespräch beenden

Externe Gespräche intern weiterleiten

MT1: 3 Sek. **INT** Während des externen Gesprächs

z. B. **2<sup>ABC</sup>** Interne Rufnummer wählen

MT2:  Internes Gespräch am anderen Mobilteil annehmen

MT1:  Gespräch weiterleiten



Sollte sich das gerufene Mobilteil nicht melden, wird das externe Gespräch nach 30 Sek. an das rufende Mobilteil zurückgestellt.

Konferenzgespräche führen

Ein externes Gespräch kann mit einem weiteren internen Gesprächspartner zum Konferenzgespräch geschaltet werden.

MT1: 3 Sek. **INT** Während des externen Gesprächs

z. B. **2<sup>ABC</sup>** Interne Rufnummer wählen

MT2:  Internes Gespräch am anderen Mobilteil annehmen

MT1: 3 Sek. **INT** Konferenz starten

MT1 / MT2:  Konferenz beenden

## Einstellen der Hörerlautstärke

Sie können während eines Gesprächs die Lautstärke in 5 Stufen anpassen.

 oder  Gewünschte Lautstärke auswählen

<sup>1</sup> Das interne Telefonieren ist nur mit mindestens zwei Mobilteilen möglich  "Verpackungsinhalt prüfen" auf Seite 5.

# Telefonieren

## Hörverstärker

Sie können neben den 5 Lautstärkestufen noch weitere Hörverstärkungen auswählen  
 Kapitel 5. Aktivieren Sie die entsprechende Verstärkung, um diese nutzen zu können.

HÖRVERSTÄRK.	Funktion
AUS	nur Lautstärke 1-5 wählbar
AN, LEISE	zusätzlich niedrige Verstärkung wählbar
AN, MITTEL	zusätzlich niedrige und mittlere Verstärkung wählbar
AN, LAUT	zusätzlich niedrige, mittlere und laute Verstärkung wählbar
AUTOMATISCH	Durch 2 Sek.  Drücken, wird die lauteste Verstärkung automatisch gewählt

## Anzeige der Gesprächsdauer

Während eines Gesprächs wird die Gesprächsdauer in Stunden, Minuten und Sekunden angezeigt.

## Freisprechen

Nutzen Sie diese Funktion, um den Gesprächspartner über den Lautsprecher zu hören.



Freisprechen einschalten



Freisprechen ausschalten

## Mikrofon im Mobilteil stummschalten

Sie können während eines Telefongesprächs das Mikrofon des Mobilteils aus- und einschalten.

3 Sek. 

Mikrofon ausschalten (stummschalten)

3 Sek. 

Mikrofon einschalten

## Tastensperre

Die Tastensperre soll verhindern, dass versehentlich Funktionen ausgelöst werden.

3 Sek. 

Tastensperre einschalten



Bei eingeschalteter Tastensperre können eingehende Anrufe wie gewohnt angenommen werden.



3 Sek. 

Tastensperre ausschalten



# Erweitern des Telefonsystems

## Mobilteil suchen (Paging)

Wenn Sie Ihr Mobilteil verlegt haben, können Sie es über einen Suchton leicht wiederfinden.

An der Basis , 

Suchton starten

 oder 

Suchton beenden

## 9 Erweitern des Telefonsystems

Über den international genormten **GAP**<sup>1</sup>-Standard ist die Kompatibilität von Mobilteilen und Basisstationen unterschiedlicher Hersteller geregelt. So ist es möglich, **SWITEL**-Geräte und Geräte anderer Hersteller zusammen in ein Telefonsystem zu integrieren. Es ist jedoch möglich, dass einige Funktionen nicht zur Verfügung stehen.

### Mehrere Mobilteile



Sie können insgesamt 5 Mobilteile an Ihre Basisstation anmelden.

#### Anmelden von Mobilteilen

Bevor Sie ein Mobilteil anmelden, müssen Sie die Basisstation in den Registriermodus setzen.

15 Sek. 

Registriermodus starten

Melden Sie nun das Mobilteil an  Kapitel 5. Benutzen Sie zur Anmeldung den aktuell eingestellten PIN-Code  Kapitel 5.

Nach dem Anmelden wird dem Mobilteil eine interne Rufnummer zugeteilt. Diese interne Rufnummer wird im Display angezeigt.



Um Mobilteile anderer Hersteller anzumelden, lesen Sie bitte deren Bedienungsanleitungen.

#### Abmelden von Mobilteilen



Sie können ein Mobilteil von einer Basisstation nur durch ein weiteres an dieser Basisstation angemeldetes Mobilteil abmelden.

Mobilteile werden über das Menü abgemeldet. Im Kapitel 5 finden Sie die Position im Menü.

<sup>1</sup> **GAP: Generic Access Profile** = Standard für das Zusammenwirken von Mobilteilen und Basisstationen unterschiedlicher Hersteller.

# Besondere Funktionen

## Mehrere Basisstationen

Sie können die Reichweite Ihres Mobilteils vergrößern, wenn Sie es an mehrere Basisstationen anmelden. Es kann gleichzeitig an 4 verschiedenen Basisstationen angemeldet sein. Jede Basisstation benötigt eine eigene Telefonsteckdose. Es können Anschlüsse mit derselben und auch mit unterschiedlichen Rufnummern sein.



Laufende Gespräche können nicht von einer zur anderen Basisstation übertragen werden.

## 10 Besondere Funktionen

### Wahlverfahren

Sie können Ihr Telefon sowohl an den analogen Vermittlungsstellen (Impuls-Wahlverfahren) als auch an den neuen digitalen Vermittlungsstellen (Ton-Wahlverfahren) betreiben. Das Wahlverfahren wird über das Menü eingestellt. Im Kapitel 5 finden Sie die Position im Menü.

## 11 Nebenstellenanlagen / Zusatzdienste

### R-Taste an Nebenstellenanlagen

Ist Ihr Telefon an einer Nebenstellenanlage angeschlossen, können Sie über die **R-Taste** Funktionen, wie z. B. Anrufe weiterleiten und automatischen Rückruf, nutzen. Lesen Sie bitte in der Bedienungsanleitung Ihrer Nebenstellenanlage, welche Flash-Zeit Sie zur Nutzung dieser Funktionen einstellen müssen. Ob Ihr Telefon an Ihrer Nebenstellenanlage einwandfrei funktioniert, erfahren Sie bei dem Händler, bei dem die Anlage gekauft wurde. Die Flash-Zeit stellen Sie über das Menü ein. Im Kapitel 5 finden Sie die Position im Menü.

### Wahlpause

Bei Nebenstellenanlagen ist es erforderlich, eine Amtskennzahl vorzuwählen, um ein Freizeichen zu bekommen. Bei wenigen älteren Nebenstellenanlagen dauert es einige Zeit, bis das Freizeichen zu hören ist. Für diese Nebenstellenanlagen kann nach der Amtskennzahl eine Wahlpause eingefügt werden, um direkt weiterwählen zu können, ohne das Freizeichen abzuwarten. Die Wahlpause fügen Sie durch Drücken und 3 Sek. halten der Taste  ein.

Nach der Amtskennzahl erfolgt die Wahl der eigentlichen Rufnummer nach einer bestimmten Zeit.



Die Wahlpause kann auch bei der Eingabe von Rufnummern im Telefonbuch gespeichert werden.



# Falls es Probleme gibt

## R-Taste und Zusatzdienste

Ihr Telefon unterstützt Zusatzdienste Ihres Netzbetreibers, wie z. B. Makeln, Anklopfen und Konferenz. Über die **R-Taste** können Sie diese Zusatzdienste nutzen. Bitte fragen Sie Ihren Netzbetreiber, welche Flash-Zeit Sie zur Nutzung von Zusatzdiensten einstellen müssen. Zur Freischaltung von Zusatzdiensten wenden Sie sich bitte an Ihren Netzbetreiber. Die Flash-Zeit stellen Sie über das Menü ein. Im Kapitel 5 finden Sie die Position im Menü.

## Rufnummernanzeige (CLIP<sup>1</sup>)



Die Rufnummernanzeige ist ein Zusatzdienst Ihres Netzbetreibers. Fragen Sie Ihren Netzbetreiber nach weiteren Informationen.

Wenn diese Funktion an Ihrer Telefonleitung zur Verfügung steht, wird Ihnen bereits die Rufnummer des Anrufers angezeigt, wenn das Telefon klingelt. Hat der Anrufer das Übertragen seiner Rufnummer unterdrückt, wird eine entsprechende Meldung angezeigt. Die Rufnummer kann nicht angezeigt und somit auch nicht in der Anrufliste gespeichert werden.

## Anrufbeantworter im Telefonnetz

Der Anrufbeantworter im Telefonnetz ist ein Zusatzdienst vieler Netzbetreiber. Wenn Ihr Netzbetreiber einen Anrufbeantworter im Telefonnetz für Sie bereitstellt, werden Sie mit einem Symbol über neue Nachrichten informiert (**VMWI**<sup>2</sup>). Über diese Funktion können Sie nur dann verfügen, wenn Ihr Netzbetreiber diesen Zusatzdienst anbietet. Bitte fragen Sie Ihren Netzbetreiber nach weiteren Informationen.

Sie können die Anzeige des Symbols für neue Nachrichten ausschalten.

Siehe Kapitel 5, VMWI OFF?.

## 12 Falls es Probleme gibt

### Service-Hotline

Haben Sie Probleme mit Ihrem Telefon, kontrollieren Sie zuerst die folgenden Hinweise. Bei technischen Problemen können Sie sich an unsere Service-Hotline unter Tel. 0900 00 1675 innerhalb der Schweiz (Kosten Swisscom bei Drucklegung: CHF 2.60/min) wenden. Bei Garantieansprüchen wenden Sie sich an Ihren Fachhändler. Die Garantiezeit beträgt 2 Jahre.

<sup>1</sup> **CLIP**: Calling Line Identification Presentation = Anzeige der Rufnummer eines Anrufers.

<sup>2</sup> **VMWI**: Visual Message Waiting Indication = Optische Anzeige neuer Nachrichten.

# Falls es Probleme gibt

## Fragen und Antworten

Fragen	Antworten
Kein Telefongespräch möglich	<ul style="list-style-type: none"><li>- Das Telefon ist nicht korrekt angeschlossen oder gestört. Verwenden Sie nur das mitgelieferte Telefonanschlusskabel.</li><li>- Testen Sie mit einem anderen Telefon, ob Ihr Telefonanschluss in Ordnung ist.</li><li>- Das Netzteil ist nicht eingesteckt oder es liegt ein totaler Stromausfall vor.</li><li>- Die aufladbaren Akkus sind leer oder defekt.</li><li>- Sie haben sich zu weit von der Basisstation entfernt.</li><li>- Wahlverfahren falsch eingestellt ☞ Seite 15.</li></ul>
Keine Verbindung zur Basisstation möglich	<ul style="list-style-type: none"><li>- Prüfen Sie, ob Sie sich mit dem richtigen PIN-Code an der Basisstation angemeldet haben ☞ Seite 15.</li></ul>
Verbindung abgehackt, fällt aus	<ul style="list-style-type: none"><li>- Sie haben sich zu weit von der Basisstation entfernt.</li><li>- Falscher Aufstellungsort der Basisstation.</li></ul>
Das System reagiert nicht mehr	<ul style="list-style-type: none"><li>- Setzen Sie alle Funktionen in den Werkstatus zurück ☞ Seite 14/15.</li><li>- Ziehen Sie kurzzeitig das Netzteil aus der Steckdose.</li></ul>
Die Akkus sind in kürzester Zeit leer	<ul style="list-style-type: none"><li>- Die Akkus sind leer oder defekt.</li><li>- Stellen Sie das Mobilteil richtig auf die Basisstation. Reinigen Sie die Kontaktflächen am Mobilteil und an der Basisstation mit einem weichen trockenen Tuch.</li><li>- Stellen Sie das Mobilteil für 16 Stunden in die Basisstation.</li></ul>
Die Rufnummernanzeige (CLIP <sup>1</sup> ) funktioniert nicht	<ul style="list-style-type: none"><li>- Die Rufnummernanzeige ist ein Zusatzdienst Ihres Netzbetreibers. Bitte fragen Sie Ihren Netzbetreiber nach weiteren Informationen.</li><li>- Der Anrufer hat das Übertragen seiner Rufnummer unterdrückt.</li></ul>

# Technische Eigenschaften

## 13 Technische Eigenschaften

### Technische Daten

Merkmal	Wert
Standard	DECT <sup>1</sup> -GAP <sup>2</sup>
Stromversorgung (Basisstation)	Eingang: 220/230 V, 50 Hz Ausgang: 6 V, 250 mA
Stromversorgung (Ladestation)	Eingang: 220/230 V, 50 Hz Ausgang: 6 V, 150 mA
Reichweite	Außen: ca. 300 m Innen: ca. 50 m
Stand-by-Zeit	Bis zu 100 h
Max. Gesprächsdauer	Bis zu 10 h
Aufladbare Akkus	2 x AAA NiMH 1.2 V
Wahlverfahren	Ton-Wahlverfahren Impuls-Wahlverfahren
Zulässige Umgebungstemperatur	10 °C bis 30 °C
Zulässige relative Luftfeuchtigkeit	20 % bis 75 %
Flash-Funktion	100 ms, 300 ms, 600 ms

<sup>1</sup> **DECT**: Digital Enhanced Cordless Telecommunication = Standard für kabellose Telefone.

<sup>2</sup> **GAP**: Generic Access Profile = Standard für das Zusammenwirken von Mobilteilen und Basisstationen unterschiedlicher Hersteller.

# Technische Eigenschaften

## Werkseinstellungen

### Mobilteil

Die Werkseinstellungen werden über das Menü wiederhergestellt. Auf Seite 14 finden Sie die Position im Menü.

SPRACHE = DEUTSCH	TELEFONBUCH = leer
ANRUFLISTE = leer	WAHLWIEDERH. = leer
M1, M2 = leer	ALARM 1/2 = AUS
RUFTON EXT. =1	RUFTON INT. = 2
LAUTSTÄRKE = 3	AUTO ANNAHME = AN
HÖRVERSTÄRK. = AUTOMATISCH	
BELEUCHTUNGS EINSTELLUNG = 10 Sek.	

### Basisstation

Die Werkseinstellungen werden über das Menü wiederhergestellt. Auf Seite 15 finden Sie die Position im Menü.

RUFTÖNE = 2	LAUTSTÄRKE = 1
WAHLVERFAHR. = TONWAHL	PIN = 0000

## Konformitätserklärung

Dieses Gerät erfüllt die Anforderungen der EU-Richtlinie:

1999/5/EG Richtlinie über Funkanlagen und Telekommunikationsendeinrichtungen und die gegenseitige Anerkennung ihrer Konformität. Die Konformität mit der o. a. Richtlinie wird durch das CE-Zeichen auf dem Gerät bestätigt.

Für die komplette Konformitätserklärung nutzen Sie bitte den kostenlosen Download von unserer Website [www.switel.com](http://www.switel.com).



## 14 Pflegehinweise / Garantie

### Pflegehinweise

- Reinigen Sie die Gehäuseoberflächen mit einem weichen und fusselfreien Tuch.
- Verwenden Sie keine Reinigungs- oder Lösungsmittel.

### Garantie

SWITEL - Geräte werden nach den modernsten Produktionsverfahren hergestellt und geprüft. Ausgesuchte Materialien und hoch entwickelte Technologien sorgen für einwandfreie Funktion und lange Lebensdauer. Ein Garantiefall liegt nicht vor, wenn die Ursache einer Fehlfunktion des Geräts bei dem Telefonnetzbetreiber oder einer eventuell zwischengeschalteten Nebenstellenanlage liegt. Die Garantie gilt nicht für die in den Produkten verwendeten Batterien, Akkus oder Akkupacks. Die Garantiezeit beträgt 24 Monate, gerechnet vom Tage des Kaufs.

Innerhalb der Garantiezeit werden alle Mängel, die auf Material- oder Herstellungsfehler zurückzuführen sind, kostenlos beseitigt. Der Garantieanspruch erlischt bei Eingriffen durch den Käufer oder durch Dritte. Schäden, die durch unsachgemäße Behandlung oder Bedienung, natürliche Abnutzung, durch falsches Aufstellen oder Aufbewahren, durch unsachgemäßen Anschluss oder Installation sowie durch höhere Gewalt oder sonstige äußere Einflüsse entstehen, fallen nicht unter die Garantieleistung. Wir behalten uns vor, bei Reklamationen die defekten Teile auszubessern, zu ersetzen oder das Gerät auszutauschen. Ausgetauschte Teile oder ausgetauschte Geräte gehen in unser Eigentum über. Schadenersatzansprüche sind ausgeschlossen, soweit sie nicht auf Vorsatz oder grober Fahrlässigkeit des Herstellers beruhen.

Sollte Ihr Gerät dennoch einen Defekt innerhalb der Garantiezeit aufweisen, wenden Sie sich bitte unter Vorlage Ihrer Kaufquittung ausschließlich an das Geschäft, in dem Sie Ihr SWITEL - Gerät gekauft haben. Alle Gewährleistungsansprüche nach diesen Bestimmungen sind ausschließlich gegenüber Ihrem Fachhändler geltend zu machen. Nach Ablauf von zwei Jahren nach Kauf und Übergabe unserer Produkte können Gewährleistungsrechte nicht mehr geltend gemacht werden.

# Stichwortverzeichnis

---

## 15 Stichwortverzeichnis

### A

Abmelden, 15, 23  
Akkuladezustand, 7  
Akkus einlegen, 6  
Ändern, 17  
Anmelden, 15, 23  
Anrufannahme, 7, 20  
Anrufbeantworter im Telefonnetz, 25  
Anrufen, 20  
Anrufliste, 12, 18  
Aufladen, 7  
Auflegen, 20

### B

Basisstation, 5, 24  
Bedienelemente, 8  
Bedienung, 9

### C

CLIP, 25

### D

Datum, 7  
Direktwahl, 18, 21  
Display, 10  
Displaymeldungen, 18  
Displaysprache, 7  
Displaysymbole, 10

### E

ECO-Mode, 7  
Erstellen, 11, 16  
Erweiterung, 23

### F

Fehlerbehebung, 25  
Fragen und Antworten, 26  
Freisprechen, 22  
Funktionen, 24

### G

Garantie, 29  
Gespräch beenden, 20  
Gesprächsdauer, 22  
Gesprächsweiterleitung, 21

### H

Hauptmenü, 12  
Headsetanschluss, 8  
Hörerlautstärke, 21  
Hörverstärker, 22

### I

Impuls-Wahlverfahren, 15, 24  
Inbetriebnahme, 5  
Interngespräche, 21

### K

Konferenzgespräche, 21  
Konformitätserklärung, 28

### L

Ladestation, 6  
Löschen, 17, 19

### M

Meldungen, 18  
Menüstruktur, 12  
Mikrofonstummschaltung, 22  
Mobilteil, 23

# Stichwortverzeichnis

---

## N

Namenseingabe, 16  
Nebenstellenanlagen, 24

## P

Paging, 23  
Pflegehinweise, 29  
Probleme, 25

## R

R-Taste, 24, 25  
Rückruf, 20  
Rufnummernanzeige, 18, 25

## S

Schreibweisen, 9  
Service-Hotline, 25  
Sicherheitshinweise, 4  
Speichern, 11, 16, 19  
Stand-by-Modus, 10  
Strahlungsreduzierung, 7  
Stummschaltung, 22  
Suchen, 23  
Symbole, 10

## T

Tastensperre, 22  
Technische Daten, 27  
Telefonbuch, 12, 16, 20  
Telefonbucheinträge, 11, 16  
Telefonieren, 20  
Texteingabe, 16  
Ton-Wahlverfahren, 15, 24  
Tonrufmelodie, 13, 15

## U

Uhrzeit, 7

## V

Verpackungsinhalt, 5  
VMWI, 25

## W

Wählen, 20  
Wahlpause, 24  
Wahlverfahren, 15, 24  
Wahlwiederholung, 13, 20  
Wecker, 13  
Weiterleitung, 21  
Werkseinstellungen, 14, 15, 28

## Z

Zusatzdienste, 24

# Notizen

---

## Notizen



## Table des matières

1	Consignes de sécurité . . . . .	34
2	Mettre le téléphone en service . . . . .	35
3	Éléments de manipulation . . . . .	38
4	Introduction . . . . .	39
5	Structure du menu . . . . .	42
6	Répertoire . . . . .	46
7	Liste d'appels . . . . .	48
8	Téléphoner . . . . .	50
9	Élargissement du système téléphonique . .	53
10	Fonctions particulières . . . . .	54
11	Installations PABX / Services confort . . . .	54
12	En cas de problèmes . . . . .	55
13	Caractéristiques techniques . . . . .	57
14	Remarques d'entretien / Garantie . . . . .	59
15	Index . . . . .	60

# Consignes de sécurité

---

## 1 Consignes de sécurité

Lisez très attentivement ce mode d'emploi.

### Utilisation conforme aux prescriptions

Ce téléphone convient pour téléphoner à l'intérieur d'un réseau téléphonique. Tout autre utilisation est considérée comme non conforme à l'usage. Des modifications ou changements effectués d'un propre gré ne sont pas autorisés. N'ouvrez en aucun cas l'appareil et n'effectuez aucun essai de réparation vous-même.

### Lieu d'installation

Évitez les nuisances causées par la fumée, la poussière, les vibrations, les produits chimiques, l'humidité, la grande chaleur ou un ensoleillement direct.

Ne vous servez pas du combiné dans des endroits exposés aux explosions.

### Bloc secteur



**Attention** : N'utilisez que le bloc secteur fourni avec l'appareil, d'autres pouvant endommager votre téléphone. Vous ne devez pas bloquer l'accès au bloc secteur par des meubles ou d'autres objets.

### Piles rechargeables



**Attention** : Ne jetez jamais les piles rechargeables dans le feu. N'utilisez que des piles rechargeables du même type ! Observez une polarisation correcte ! Il y a risque d'explosion lors de leur chargement si la polarisation est incorrecte.

### Panne de courant

En cas de panne de courant, il n'est pas possible de téléphoner avec cet appareil. Pour les cas d'urgence, ayez à votre disposition un téléphone à fil fonctionnant sans alimentation externe en courant.

### Appareils médicaux



**Attention** : N'utilisez pas ce téléphone à proximité d'appareils médicaux. Son influence ne peut pas être entièrement exclue.

### Compatible avec les prothèses auditives

Ce téléphone est compatible avec la plupart des prothèses auditives en vente sur le marché. Cependant, un fonctionnement irréprochable ne peut être garanti pour chacune d'entre elles.

Les téléphones **DECT**<sup>1</sup> peuvent causer un bourdonnement désagréable dans les prothèses auditives.

<sup>1</sup> **DECT**: Digital Enhanced Cordless Telecommunication = Standard pour les téléphones sans fil.

# Mettre le téléphone en service

## Élimination

Si vous ne voulez plus vous servir de votre appareil, veuillez l'apporter au centre de collecte de l'organisme d'élimination des déchets de votre commune (par ex. centre de recyclage). L'icône ci-contre signifie que vous ne devez en aucun cas jeter votre appareil dans les ordures ménagères !

D'après la loi relative aux appareils électriques et électroniques, les propriétaires d'appareils usagés sont tenus de mettre tous les **appareils électriques et électroniques** usagés dans un collecteur séparé. Éliminez les

**pile rechargeables** auprès d'un revendeur spécialisé ainsi que dans des centres de collecte qui tiennent à votre disposition les collecteurs appropriés correspondants.

Éliminez les **fournitures d'emballage** conformément au règlement local.



## 2 Mettre le téléphone en service

### Remarques concernant la sécurité



**Attention** : Avant de mettre votre appareil en service, lisez impérativement les consignes de sécurité mentionnées au chapitre 1.

### Vérifier le contenu de l'emballage

Les éléments suivants font partie de la livraison :

Contenu	Modèle DC62x <sup>1</sup>			
	621	622	623	624
Base avec bloc secteur	1	1	1	1
Chargeur avec bloc secteur	-	1	2	3
Combiné	1	2	3	4
Câble de raccordement téléphonique	1	1	1	1
Piles rechargeables	2	4	6	8
Mode d'emploi	1	1	1	1

<sup>1</sup> À l'adresse [www.switel.com](http://www.switel.com), vous apprendrez si ce téléphone/kit téléphonique est déjà disponible à la vente.

# Mettre le téléphone en service

## Raccorder la base



**Attention** : Posez la base à une distance minimum d'1 m par rapport à d'autres appareils électroniques, une distance inférieure pouvant provoquer des interactions.

Raccordez la base comme représenté sur le croquis. Pour des raisons de sécurité, n'utilisez que le bloc secteur fourni avec l'appareil ainsi que le câble de raccordement téléphonique ci-joint.

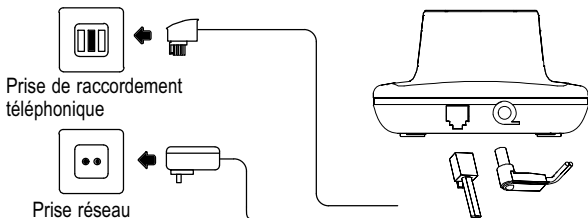

Pour la base, utilisez le bloc secteur portant le n° VD760025D (ou BD060025D) et les données de sortie 6 V, 250 mA.

## Raccorder le chargeur<sup>1</sup>

Raccordez le chargeur tel que représenté sur le croquis. Pour des raisons de sécurité, n'utilisez que le bloc secteur fourni avec l'appareil.

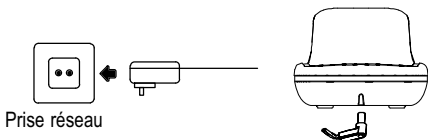

Pour le chargeur, utilisez le bloc secteur portant le n° VD060015D (ou BD060015D) et les données de sortie 6 V, 150 mA.

<sup>1</sup> Valable uniquement pour les kits téléphoniques équipés d'au moins deux combinés ➤ "Vérifier le contenu de l'emballage" à la page 35.

# Mettre le téléphone en service

## Mettre en place les piles rechargeables

Insérez les piles rechargeables dans le compartiment à piles ouvert. N'utilisez que des piles rechargeables de type AAA NiMH 1,2 V. Observez une polarisation correcte ! Fermez le compartiment à piles.

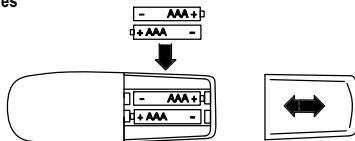

## Recharger les piles rechargeables



Lors de la première mise en service, laissez le combiné pendant **au moins 16 heures** sur la base / le chargeur.

[Si vous avez placé le combiné correctement sur la base / le chargeur, un signal indicateur se fait entendre.][Si vous avez placé le combiné correctement sur la base / le chargeur, le voyant de contrôle de charge s'allume.] Le combiné chauffe lors du chargement. C'est normal et inoffensif. Ne chargez pas le combiné avec des chargeurs d'autres fabricants. Le **niveau actuel de chargement des piles rechargeables** est affiché à l'écran :



Plein



Moyen



Faible



Vide

## Paramétrer la langue de l'écran

Sélectionnez la langue correspondante (voir également "Structure de menu"):

(☞) > MOBILTEIL > SPRACHE >...

(☞) > RÉGL. TÉL. > LANGUE >...

Les langues allemand, français, italien et anglais sont disponibles.

## Régler l'heure et la date du combiné

Vous réglez l'heure et la date via le menu. La page 43 vous donnera la position dans le menu.

## Prise d'appel automatique

Si vous avez activé cette fonction, l'appel sera automatiquement pris lorsque vous retirerez le combiné de la base. La prise d'appel automatique s'active ou se désactive via le menu. La page 44 vous donnera la position dans le menu.

## Installations PABX

La page 54 vous donnera de plus amples informations au cas où vous désireriez raccorder votre téléphone à une installation PABX.

# Éléments de manipulation

## Réduction du rayonnement (mode ÉCO)

Le rayonnement est, comparé aux téléphones sans fil DECT standard, considérablement réduit en mode veille quand le combiné repose sur la base.

En mode de communication, le rayonnement est réduit en fonction de l'éloignement du combiné par rapport à la base.



## 3 Éléments de manipulation

Dans ce mode d'emploi, les touches de votre téléphone seront représentées par la suite par des icônes encadrées standardisées. Il peut donc y avoir de légères différences entre les icônes des touches de votre téléphone et celles des touches utilisées ici.

### Combiné

- 1 Haut-parleur
- 2 Écran à CL
- 3 Touche OK / de menu
- 4 Touche de sélection rapide M2
- 5 Raccord du casque
- 6 Touche R / d'effacement
- 7 Touche mains-libres
- 8 Pavé numérique
- 9 Touche # / Verrouillage du clavier
- 10 Microphone
- 11 Touche de pause
- 12 Touche \* / Communications internes
- 13 Touche de communication / de rattachement
- 14 Touche fléchée en bas / Liste d'appels
- 15 Touche de sélection rapide M1
- 16 Touche fléchée en haut / Répétition automatique des derniers numéros
- 17 Diode électroluminescente

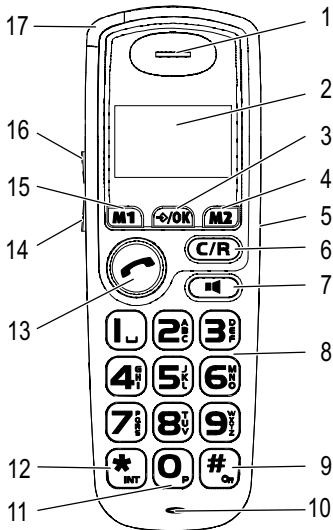

## Raccord du casque

Sur le côté droit du combiné, vous trouverez une possibilité de raccorder un casque. Utilisez un casque avec une fiche à jack stéréo de 2,5 mm. Nous ne pouvons pas garantir un fonctionnement parfait.

## Base

- 1 Contacts de chargement
- 2 Touche de paging
- 3 DEL de chargement
- 4 DEL d'état de fonctionnement

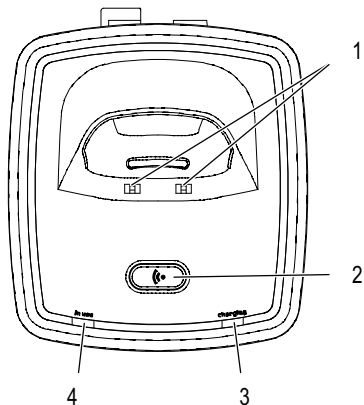





## 4 Introduction

Dans ce chapitre, vous trouverez des informations de base vous expliquant comment vous servir du mode d'emploi et du téléphone.









### Mode de représentation dans le mode d'emploi

Visualisation	Description
	Visualisation des touches
	Appuyer brièvement sur la touche représentée
2 sec.	Appuyer 2 secondes sur la touche représentée
	Saisir des chiffres ou des lettres

# Introduction

	Le combiné sonne
	Prendre le combiné de la base
	Poser le combiné sur la base
	Visualisation des textes de l'écran
	Visualisation des icônes de l'écran

## Icônes et textes à l'écran du combiné

Icône	Description
	Constant : affichage de la capacité des piles. Clignotant : rechargez les piles rechargeables. Segments continus : les piles rechargeables se rechargent ☞ page 37.
1	Numéro d'appel interne du combiné ☞ page 53
12--59	Affichage de l'heure ☞ page 43
	Vous passez une communication ☞ page 50.
	Vous vous trouvez dans la liste d'appels. De nouveaux appels se trouvent dans la liste d'appels ☞ page 48.
	La sonnerie est débranchée ☞ page 43.
	Le mode mains-libres est activé ☞ page 52.
	Le verrouillage du clavier est activé ☞ page 53.
	La fonction d'alarme est branchée.
MESSAGE EN AT- TENTE	Répondeur dans le réseau téléphonique. <b>Services confort VMWI</b> <sup>1</sup> de votre opérateur ☞ page 55.
	La liaison avec la base est bonne.

<sup>1</sup> **VMWI**: **V**isual **M**essage **W**aiting **I**ndication = Affichage optique de nouveaux messages.

















# Introduction

## Mode veille

Toutes les descriptions dans ce mode d'emploi partent du principe que le combiné se trouve en mode veille. Le combiné se trouve en mode veille quand aucune communication n'a lieu et qu'aucun menu n'est ouvert. Appuyez, le cas échéant, plusieurs fois sur la touche  pour accéder au mode veille.

## Navigation dans le menu

Vous pouvez accéder à toutes les fonctions via différents menus. La structure de menu vous montre comment accéder à la fonction désirée  page42.









	Ouvrir le menu principal
 ou 	Sélectionner le sous-menu désiré
	Ouvrir le sous-menu
 ou 	Sélectionner la fonction désirée
	Ouvrir la fonction
 ou 	Sélectionner le réglage désiré
	Saisir des chiffres ou des lettres via le pavé numérique
	Confirmer les entrées
	Reculer d'une position
Plusieurs fois, le cas échéant 	Annuler les opérations de programmation et de sauvegarde et retourner en mode veille



Chaque opération est automatiquement annulée si vous n'effectuez pas de saisie dans les 15 secondes.

## Créer des enregistrements dans le répertoire - exemple

L'exemple **Créer des enregistrements du répertoire** vous explique ici comment naviguer dans les menus et effectuer des paramétrages. Pour tous les paramétrages, procédez comme dans cet exemple.

	Ouvrir le menu principal
RÉPERTOIRE 	Ouvrir le répertoire
	Sauter la sélection d'enregistrements
NOUVELLE ENTRÉE 	Sélectionner le sous-menu et confirmer
 	Saisir le nom (max. 12 caractères) et confirmer
 	Saisir le numéro d'appel (max. 24 chiffres) et confirmer

# Structure du menu





## 5 Structure du menu

### Menu principal



Vous parvenez au menu principal en appuyant sur la touche . Ensuite, sélectionnez un enregistrement à l'aide des touches  ou  et confirmez votre sélection avec la touche .

Pour d'autres informations relatives au menu et à la manipulation  chapitre 4.

RÉPERTOIRE, / Sélectionner l'enregistrement,  Sauter

NOUVELLE ENTRÉE	NOM  <sup>1</sup>	NUMÉRO 
MODIFIER	NOM 	NUMÉRO 
SUPPRIMER MÉMOIRE	CONFIRMER?	
SUPPR. TOUT	CONFIRMER?	

JRNAL APPELS<sup>2</sup>, / Sélectionner l'enregistrement,  Sauter

ENREGISTRER RÉPERTOIRE	NOM 	NUMÉRO 
SUPPRIMER MÉMOIRE	CONFIRMER?	
SUPPR. TOUT	CONFIRMER?	

<sup>1</sup> Des lettres sont gravées sur les touches numériques. En appuyant plusieurs fois sur la touche adéquate, vous pouvez saisir des lettres, des chiffres et des symboles.

<sup>2</sup> L' affichage du numéro d'appel (**CLIP**<sup>3</sup>) est nécessaire pour l'affichage et la sauvegarde de numéros d'appel dans les listes d'appels. L'affichage du numéro d'appel est un service confort de votre opérateur. Veuillez lui demander de plus amples informations. Pour d'autres informations sur l'affichage du numéro d'appel  page 48.

<sup>3</sup> **CLIP**: Calling Line Identification Presentation = Affichage du numéro d'appel d'un correspondant.

# Structure du menu

RECOMPOSER, /↓ Sélectionner l'enregistrement, Sauter

ENREGISTRER RÉPÉ- TOIRE	NOM	NUMÉRO
SUPPRIMER MÉMOIRE	CONFIRMER?	
SUPPR. TOUT	CONFIRMER?	



## ALARMES

ALARME 1	EFFACER		
	RÉGLER	HEURE	CONFIRMER?
ALARME 2	EFFACER		
	RÉGLER	HEURE	CONFIRMER?

## RÉGL. TÉL.

MÉLODIE APPEL	MÉLODIE EXTERNE	MÉLODIE 1-10
	MÉLODIE INTERNE	MÉLODIE 1-10
VOLUME SONNERIE	VOLUME 1-5, OFF	
RÉGLAGE DATE/HEURE	DATE/HEURE	DATE  ↗
		↗ CONFIRMER?
		HEURE  ↗
		↗ CONFIRMER?
	FORMAT DATE/HEURE	DATE  ↗
		↗ JJ/MM
		↗ MM/JJ



# Structure du menu

↵		HEURE  ↵
		↵ 12 HEURES
		↵ 24 HEURES
MODE BOOST	ON	BAS
		MOYEN
		ÉLEVÉ
	AUTO	
	OFF	
TON. TOUCHES	ON/OFF	
CONTRASTE ÉCRAN	NIVEAU 1-8	
NOM DE COMBINÉ		
RÉGLER RÉTROÉCL.	5-30 SECONDES	
AUTO TALK	ON/OFF	
LANGUE <sup>1</sup>		
DÉFAUT	CONFIRMER?	



<sup>1</sup>Pour savoir quelles langues sont disponibles, voir  chapitre 2.

# Structure du menu

## RÉGL. BASE, PIN ENTRÉE <sup>1</sup>

MÉLODIE BASE	MÉLODIE 1-5	
VOLUME SONNERIE	VOLUME 1-5, OFF	
CHANGER PIN <sup>1</sup>	NOUVEAU PIN 	CONFIRM. PIN 
MODE NUM	TONALITÉ	
	IMPULSION	
TPS CLIGNTMT	COURT	
	MOYEN	
	LONG	
MESSAGE VOC. <sup>2</sup>	MSG VOC OFF?	
DÉFAUT	CONFIRMER?	

## ENREGISTREMENT

ENREGISTRER	PIN ENTRÉE 	
SÉLECT. BASE	BASE 1-4	
SUPPRIMER COMBINÉ	PIN ENTRÉE 	COMBINÉ 1-4
EFFACER BASE	BASE 1-4	

<sup>1</sup> Le code PIN est réglé en usine sur "0000".

<sup>2</sup> **VMWI**: **V**isual **M**essage **W**aiting **I**ndication = Affichage optique de nouveaux messages.

# Répertoire

## 6 Répertoire

Vous pouvez enregistrer 100 numéros d'appel et le nom y afférant dans votre répertoire.

- Saisissez toujours les numéros d'appel avec l'indicatif afin que le téléphone puisse aussi attribuer les communications locales entrantes à un enregistrement du répertoire.
- Si la capacité de mémoire est épuisée, l'écran affiche le message suivant **MÉM. PLEINE** lors du prochain enregistrement. Pour créer de la place, vous devez tout d'abord effacer un autre enregistrement.
- Les enregistrements du répertoire sont rangés par ordre alphabétique.

### Saisir le nom

Des lettres sont gravées sur les touches numériques. En appuyant plusieurs fois sur la touche adéquate, vous pouvez saisir des lettres, des chiffres et des symboles.

<b>1</b>	Entrer des espaces
<b>C</b>	Effacer
<b>▲</b> ou <b>▼</b>	Déplacer le curseur



Pour saisir deux fois la même lettre, appuyez sur la touche correspondante. Attendez que le curseur soit passé derrière la lettre. Puis tapez la lettre une nouvelle fois.

### Créer des enregistrements dans le répertoire

	Ouvrir le menu principal
RÉPERTOIRE	Ouvrir le répertoire
	Sauter la sélection d'enregistrements
NOUVELLE ENTRÉE	Sélectionner le sous-menu et confirmer
	Saisir le nom (max. 12 caractères) et confirmer
	Saisir le numéro d'appel (max. 24 chiffres) et confirmer

## Modifier des enregistrements du répertoire

<input type="button" value="↩"/>	Ouvrir le menu principal
<input type="button" value="RÉPERTOIRE"/> <input type="button" value="↩"/>	Ouvrir le répertoire
<input type="button" value="▲ ou ▼"/> <input type="button" value="↩"/>	Sélectionner l'enregistrement, confirmer
<input type="button" value="▲ ou ▼"/> <input type="button" value="MODIFIER"/> <input type="button" value="↩"/>	Sélectionner le sous-menu et confirmer
<input type="button" value="⌨"/> <input type="button" value="↩"/>	Modifier le nom et confirmer
<input type="button" value="⌨"/> <input type="button" value="↩"/>	Modifier le numéro d'appel et confirmer

## Effacer les enregistrements du répertoire

### Effacer un enregistrement

<input type="button" value="↩"/>	Ouvrir le menu principal
<input type="button" value="RÉPERTOIRE"/> <input type="button" value="↩"/>	Ouvrir le répertoire
<input type="button" value="▲ ou ▼"/> <input type="button" value="↩"/>	Sélectionner l'enregistrement, confirmer
<input type="button" value="▲ ou ▼"/> <input type="button" value="SUPPRIMER MÉMOIRE"/> <input type="button" value="↩"/>	Sélection le sous-menu et confirmer
<input type="button" value="CONFIRMER?"/> <input type="button" value="↩"/> ou <input type="button" value="C"/>	Confirmer l'effacement ou annuler l'opération

### Effacer tous les enregistrements

<input type="button" value="↩"/>	Ouvrir le menu principal
<input type="button" value="RÉPERTOIRE"/> <input type="button" value="↩"/>	Ouvrir le répertoire
<input type="button" value="↩"/>	Sauter la sélection d'enregistrements
<input type="button" value="▲ ou ▼"/> <input type="button" value="SUPPR. TOUT"/> <input type="button" value="↩"/>	Sélectionner le sous-menu et confirmer
<input type="button" value="CONFIRMER?"/> <input type="button" value="↩"/> ou <input type="button" value="C"/>	Confirmer l'effacement ou annuler l'opération

# Liste d'appels

## Sélection directe

Vous pouvez enregistrer 1 numéro d'appel comme sélection directe sur chacune des touches **M1** et **M2**.

Enregistrer des numéros d'appel comme sélection directe

Saisissez un numéro ou sélectionnez un enregistrement à partir du répertoire, de la liste de répétition automatique des derniers numéros ou de la liste d'appels.

3 sec. **M1** ou **M2**

Sélection enregistrée sur la touche de sélection directe correspondante



Des enregistrements sur les touches de sélection directe ne peuvent pas être effacés mais seulement être écrasés.

## 7 Liste d'appels

Dans l'ensemble, 20 numéros d'appel sont enregistrés dans une liste d'appels.



L'affichage du numéro d'appel (**CLIP**<sup>1</sup>) est un service confort de votre opérateur. Votre téléphone affiche les numéros d'appel à l'écran si votre opérateur offre ce service. Veuillez lui demander de plus amples informations.

Messages à l'écran :

INDISPONIBLE	Le numéro est reçu partiellement ou incorrectement.
LONGUE DIST.	L'information du numéro d'appel n'est pas disponible. Il pourrait s'agir d'une communication internationale.
SECRET	Le correspondant a bloqué la transmission de son numéro d'appel.

## Faire afficher des numéros de la liste d'appels

, ou

Ouvrir la liste d'appel et sélectionner l'enregistrement

Le cas échéant, appuyez plusieurs fois sur la touche pour passer à l'écran, de l'affichage "Nom" à "Numéro" et à "Heure d'entrée".

<sup>1</sup> **CLIP**: Calling Line Identification Presentation = Affichage du numéro d'appel d'un correspondant.



# Liste d'appels

## Sauvegarder dans le répertoire des numéros d'appel de la liste d'appels

Vous pouvez enregistrer un numéro d'appel dans le répertoire directement à partir de la liste d'appels.



Ouvrir la liste d'appel et sélectionner l'enregistrement



Ouvrir le menu



ENREGISTRER  
RÉPERTOIRE



Sélectionner le sous-menu et confirmer



Saisir le nom (max. 12 caractères) et confirmer



Modifier le numéro d'appel et confirmer



Dès que le numéro a été enregistré avec un nom dans le répertoire, ce nom apparaît dans la liste d'appels.

## Effacer des numéros de la liste d'appels

Effacer des numéros individuels



Ouvrir la liste d'appel et sélectionner l'enregistrement



Ouvrir le menu



SUPPRIMER  
MÉMOIRE



Sélectionner le sous-menu et confirmer

CONFIRMER?



Confirmer l'effacement ou annuler l'opération

Effacer tous les numéros d'appel



Ouvrir la liste d'appels



Ouvrir le menu



SUPPR. TOUT



Sélectionner le sous-menu et confirmer

CONFIRMER?



Confirmer l'effacement ou annuler l'opération

# Téléphoner

## 8 Téléphoner

### Prendre un appel



Prendre l'appel

### Terminer la communication



Terminer la communication

### Appeler



Composer le numéro d'appel (max. 24 chiffres)



En cas de saisie erronée, effacer le dernier chiffre

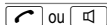

Composer le numéro d'appel



Vous pouvez aussi appuyer d'abord sur la touche , vous obtenez ainsi la tonalité. Les chiffres saisis de votre numéro d'appel seront immédiatement composés. Une correction individuelle des chiffres du numéro n'est pas possible quand la communication est établie de cette manière.

### Touche de répétition automatique des derniers numéros

Votre téléphone enregistre les 10 derniers numéros composés dans une liste de répétition automatique des derniers numéros.



Ouvrir la liste de répétition automatique des derniers numéros et sélectionner l'enregistrement



Établir la communication

Le traitement de numéros d'appel placés dans une liste de répétition automatique des derniers numéros est identique à celui des numéros de la liste d'appels  chapitre 7.

### Rappeler des numéros d'appel entrés

Votre téléphone enregistre 20 numéros d'appel dans une liste d'appels.



Ouvrir la liste d'appel et sélectionner l'enregistrement



Établir la communication

### Composer des numéros d'appel à partir du répertoire

Vous devez avoir enregistré des numéros d'appel dans le répertoire.  chapitre 6



Ouvrir le menu principal



Ouvrir le répertoire



Sélectionner l'enregistrement, établir la communication

# Téléphoner

## Sélection directe

Vous devez avoir enregistré des numéros d'appel comme numéros de sélection directe ➤ chapitre 5.

3 sec. **M1** ou **M2** Procéder à la sélection directe

## Téléphoner en interne<sup>1</sup>

Téléphoner en interne

Vous devez avoir déclaré deux ou plusieurs combinés (CB1, CB2, ...) sur votre base afin de pouvoir téléphoner gratuitement en interne.

CB1 : 3 sec. **INT** Introduire la communication interne

Par ex. **2<sup>ABC</sup>** Composer le numéro interne du combiné désiré

CB2 :  Prendre une communication interne sur un autre combiné

CB1 / CB2 :  Terminer une communication interne

## Transférer des communications externes en interne

CB1 : 3 sec. **INT** Pendant la communication externe

Par ex. **2<sup>ABC</sup>** Composer un numéro d'appel interne

CB2 :  Prendre une communication interne sur un autre combiné

CB1 :  Transférer une communication



Si le combiné appelé ne répond pas, la communication externe retourne au combiné appelant au bout de 30 sec.

## Mener des conférences téléphoniques

Une communication externe peut être transformée en conférence téléphonique avec un autre correspondant interne.

CB1 : 3 sec. **INT** Pendant la communication externe

Par ex. **2<sup>ABC</sup>** Composer un numéro d'appel interne

CB2 :  Prendre une communication interne sur un autre combiné

CB1 : 3 sec. **INT** Démarrer la conférence

CB1 / CB2 :  Terminer la conférence

<sup>1</sup> Téléphoner en interne n'est possible qu'avec au moins deux combinés ➤ "Contrôler le contenu de l'emballage" à la page 35.

# Téléphoner

## Régler le volume sonore de l'écouteur

Vous pouvez régler le volume sonore sur 5 sensibilités pendant une communication.



Sélectionner le volume sonore désiré

## Amplificateur sonore

En plus des 5 sensibilités de volume, vous pouvez sélectionner d'autres amplifications sonores  chapitre 5. Activez l'amplification correspondante pour pouvoir vous en servir.

MODE BOOST	Fonction
OFF	Seul le volume sonore 1-5 est sélectionnable
ON, BAS	Amplification basse sélectionnable en plus
ON, MOYEN	Amplifications basse et moyenne sélectionnables en plus
ON, ÉLEVÉ	Amplifications basse, moyenne et forte sélectionnables en plus
AUTO	En appuyant pendant 2 sec. sur  on sélectionne automatiquement l'amplification la plus forte

## Affichage de la durée de la communication

La durée d'une communication est affichée en heures, minutes et secondes.

## Mode mains-libres

Utilisez cette fonction pour entendre le correspondant par l'intermédiaire du haut-parleur.



Activer le mode mains-libres



Désactiver le mode mains-libres

## Mettre le microphone du combiné sur silencieux

Pendant une communication, vous pouvez activer et désactiver le microphone du combiné.



Désactiver le microphone (le mettre sur silencieux)



Activer le microphone

# Élargissement du système téléphonique

## Verrouillage du clavier

Le verrouillage du clavier doit empêcher que des fonctions soient déclenchées par inadvertance.

3 sec. 

Activer le verrouillage du clavier





Lorsque le verrouillage du clavier est activé, vous pouvez comme d'habitude réceptionner des appels entrants.

3 sec. 



Désactiver le verrouillage du clavier

## Chercher le combiné (Paging)

Si vous avez égaré votre combiné, vous pouvez le retrouver facilement grâce à un son de recherche.

Sur la base , 

Démarrer le son de recherche

 ou 

Terminer le son de recherche

## 9 Élargissement du système téléphonique

Le mode standard international normé **GAP**<sup>1</sup> règle la compatibilité entre les combinés et les bases de fabricants différents. Il est ainsi possible d'intégrer ensemble des appareils **SWITEL** et des appareils d'autres fabricants dans un système téléphonique. Il est toutefois possible que certaines fonctions ne soient pas disponibles.

### Plusieurs combinés

Vous pouvez déclarer 5 combinés sur votre base.

#### Déclaration de combinés

Avant de déclarer un combiné, vous devez mettre la base en mode de déclaration.

15 sec. 

Démarrer le mode de déclaration

Déclarez maintenant le combiné ☞ chapitre 5. Pour la déclaration, utilisez le code PIN actuellement paramétré ☞ chapitre 5.

Après la déclaration, un numéro d'appel interne est attribué au combiné. Ce numéro interne s'affiche à l'écran.



Pour déclarer des combinés d'autres fabricants, veuillez lire leur mode d'emploi.

#### Annulation de combinés



Vous ne pouvez annuler un combiné d'une base que par un autre combiné déclaré sur cette base.

Les combinés s'annulent via le menu. Vous trouverez la position dans le menu au chapitre 5.

<sup>1</sup> **GAP**: **Generic Access Profile** = Standard pour l'action conjointe de combinés et de bases de fabricants différents.

# Fonctions particulières

## Plusieurs bases

Vous pouvez élargir la portée de votre combiné si vous le déclarez sur plusieurs bases. Il peut être déclaré simultanément sur 4 bases différentes. Chaque base a besoin d'une prise téléphonique individuelle. Ces raccordements peuvent porter le même numéro d'appel ou bien des numéros différents.



Les communications en cours ne peuvent pas être transférées d'une base à l'autre.

## 10 Fonctions particulières

### Système de numérotation

Vous pouvez utiliser votre téléphone tant avec les centrales téléphoniques analogiques (numérotation par impulsions) qu'avec les nouvelles centrales téléphoniques numériques (numérotation par tonalité). Le système de numérotation est programmé via le menu. Vous trouvez la position dans le menu au chapitre 5.

## 11 Installations PABX / Services confort

### Touche R sur des installations PABX

Si votre téléphone est raccordé à une installation PABX, vous pouvez, via la **touche R**, tirer profit de certaines fonctions comme par ex. le transfert d'appels et le rappel automatique. Veuillez lire dans le mode d'emploi de votre installation PABX quel temps de flash vous devez paramétrer pour l'utilisation de ces fonctions. Le revendeur, chez lequel vous avez acheté l'installation, vous dira si votre téléphone fonctionne impeccablement sur votre installation PABX. Le temps de flash se paramètre via le menu. Vous trouverez la position dans le menu au chapitre 5.

### Pause de numérotation

Dans le cas d'installations PABX, il est nécessaire de composer auparavant un code réseau pour obtenir la tonalité. Sur quelques installations PABX plus anciennes, vous devez attendre quelques instants avant de pouvoir entendre la tonalité. Pour ces installations PABX, une pause de numérotation peut être insérée après le code réseau afin de pouvoir continuer à numérotter directement sans attendre la tonalité. Vous insérez la pause de numérotation en appuyant sur la touche **P** et en la maintenant 3 sec. appuyée.

Après le code réseau, le numéro est composé au bout d'un temps déterminé.



La pause peut également être enregistrée lors de la saisie de numéros d'appel dans le répertoire.

# En cas de problèmes

## Touche R et services confort

Votre téléphone supporte des services confort de votre opérateur tels que le va-et-vient, la signalisation d'appel en instance et la conférence. Vous pouvez les utiliser via la **touche R**. Demandez à votre opérateur quel temps de flash vous devez paramétrer pour utiliser ces services conforfs. Contactez votre opérateur pour déconnecter ces services. Le temps de flash se paramètre via le menu. Vous trouverez la position dans le menu au chapitre 5.

## Affichage du numéro d'appel (CLIP<sup>1</sup>)



L'affichage du numéro d'appel est un service confort de votre opérateur. Veuillez lui demander de plus amples informations.

Si cette fonction est disponible sur votre ligne téléphonique, le numéro d'appel du correspondant vous sera affiché dès que le téléphone sonnera. Si votre correspondant a bloqué la transmission de son numéro, un message correspondant sera affiché. Le numéro d'appel ne peut pas être affiché et ainsi ne peut pas non plus être sauvegardé dans la liste d'appels.

## Répondeur dans le réseau téléphonique

Le répondeur dans le réseau téléphonique est un service confort offert par de nombreux opérateurs. Si votre opérateur met à votre disposition un répondeur dans le réseau téléphonique, vous serez informé par une icône de l'arrivée de nouveaux messages (**VMWI**<sup>2</sup>). Vous ne pouvez disposer de cette fonction que si votre opérateur offre ce service. Veuillez lui demander de plus amples informations.

Vous pouvez désactiver l'affichage de l'icône des nouveaux messages. Voir chapitre 5, MSG VOC OFF?.

## 12 En cas de problèmes

### Hotline de service

Si vous avez des problèmes avec votre téléphone, contrôlez d'abord les indications suivantes. S'il s'agit de problèmes techniques, vous pouvez vous adresser à notre hotline de service en Suisse au numéro de tel. 0900 00 1675 (frais Swisscom à la date d'impression de ce manuel : CHF 2.60/min). En cas de droits de garantie, veuillez vous adresser à votre revendeur. La durée de la garantie est de 2 ans.

<sup>1</sup> **CLIP**: Calling Line Identification Presentation = Affichage du numéro d'appel d'un correspondant.

<sup>2</sup> **VMWI** : Visual Message Waiting Indication = Affichage optique de nouveaux messages.

# En cas de problèmes

## Questions et réponses

Questions	Réponses
Pas de communication téléphonique possible	<ul style="list-style-type: none"><li>- Le téléphone n'est pas raccordé correctement ou est en dérangement. N'utilisez que le câble de raccordement téléphonique fourni avec l'appareil.</li><li>- Testez avec un autre téléphone si votre raccordement téléphonique fonctionne.</li><li>- Le bloc secteur n'est pas branché ou il y a une panne totale de courant.</li><li>- Les piles rechargeables sont vides ou défectueuses.</li><li>- Vous vous êtes trop éloigné de la base.</li><li>- Programmation erronée du système de numérotation ☞ page 45.</li></ul>
Pas de connexion possible avec la base	<ul style="list-style-type: none"><li>- Contrôlez que vous vous êtes déclaré sur la base avec le code PIN correct ☞ page 45.</li></ul>
La liaison est hâchée, s'interrompt	<ul style="list-style-type: none"><li>- Vous vous êtes trop éloigné de la base.</li><li>- Mauvais lieu d'installation de la base.</li></ul>
Le système ne réagit plus	<ul style="list-style-type: none"><li>- Remettez toutes les fonctions en configuration usine ☞ page 44/45.</li><li>- Retirez le bloc secteur de la prise de courant pendant un court instant.</li></ul>
Les piles rechargeables se vident très rapidement	<ul style="list-style-type: none"><li>- Les piles rechargeables sont vides ou défectueuses.</li><li>- Placez le combiné correctement sur la base. Nettoyez les surfaces de contact du combiné et de la base avec un chiffon doux et sec .</li><li>- Posez le combiné sur la base et laissez-le pendant 16 heures .</li></ul>
L'affichage du numéro d'appel (CLIP <sup>1</sup> ) ne fonctionne pas	<ul style="list-style-type: none"><li>- L'affichage du numéro d'appel est un service confort de votre opérateur. Veuillez lui demander de plus amples informations.</li><li>- Le correspondant a bloqué la transmission de son numéro d'appel.</li></ul>



# Caractéristiques techniques

## 13 Caractéristiques techniques

### Caractéristiques techniques

Caractéristique	Valeur
Standard	<b>DECT1-GAP<sup>2</sup></b>
Alimentation en courant (base)	Entrée : 220/230 V, 50 Hz Sortie : 6 V, 250 mA
Alimentation en courant (chargeur)	Entrée : 220/230 V, 50 Hz Sortie : 6 V, 150 mA
Portée	À l'extérieur : env. 300 m À l'intérieur : env. 50 m
Autonomie en veille	Jusqu'à 100 h
Durée max. de communication	Jusqu'à 10 h
Piles rechargeables	2 x AAA NiMH 1.2 V
Système de numérotation	Numérotation par tonalité Numérotation par impulsions
Température ambiante autorisée	10°C à 30°C
Humidité atmosphérique relative autorisée	20% à 75%
Fonction de flash	100 ms, 300 ms, 600 ms

<sup>1</sup> **DECT**: Digital Enhanced Cordless Telecommunication = Standard pour les téléphones sans fil.

<sup>2</sup> **GAP**: Generic Access Profile = Standard pour l'action conjointe de combinés et de bases de fabricants différents.

# Caractéristiques techniques

## Réglages usine

### Combiné

Les paramétrages en usine sont rétablis via le menu. La page 44 vous donnera la position dans le menu.

LANGUE = ALLEMAND	RÉPERTOIRE = vide
JRNAL APPELS = vide	RECOMPOSER = vide
M1, M2 = vide	ALARME 1/2 = OFF
MÉLODIE EXTERNE = 1	MÉLODIE INTERNE = 2
VOLUME SONNERIE = 3	AUTO TALK = ON
MODE BOOST = AUTO	
RÉGLER RÉTROÉCL. = 10 sec.	

### Base

Les paramétrages en usine sont rétablis via le menu. La page 45 vous donnera la position dans le menu.

MÉLODIE BASE = 2	VOLUME SONNERIE = 1
MODE NUM = TONALITÉ	PIN = 0000

## Déclaration de conformité

Cet appareil répond aux exigences des directives de l'union européenne (UE) : 1999/5/CE Directive sur les installations de radio et de télécommunication et la reconnaissance réciproque de leur conformité. La conformité à la directive ci-dessus est confirmée sur l'appareil par le symbole CE.

Pour obtenir la déclaration de conformité intégrale, veuillez vous servir du téléchargement gratuit de notre site Internet [www.switel.com](http://www.switel.com).



# Remarques d'entretien / Garantie

## 14 Remarques d'entretien / Garantie

### Remarques d'entretien

- Nettoyez les surfaces du boîtier avec un chiffon doux et non pelucheux.
- N'utilisez pas de produits d'entretien ou de solvants.

### Garantie

Les appareils SWITEL sont fabriqués et contrôlés selon les procédés les plus modernes. Des matériaux sélectionnés et des technologies de pointe ont pour effet un fonctionnement irréprochable et une longue durée de vie. La garantie ne rentre pas en jeu si l'exploitant du réseau téléphonique ou une installation PABX éventuellement intercalée est responsable du dysfonctionnement de l'appareil. La garantie ne s'applique pas aux piles, piles rechargeables ou packs de piles rechargeables utilisés dans les produits. La durée de la garantie est de 24 mois à partir de la date d'achat.

Pendant la période de garantie, tous les défauts dus à des vices de matériel ou de fabrication seront éliminés gratuitement. Le droit à la garantie expire en cas d'intervention de l'acheteur ou de tiers. Les dommages provenant d'un maniement ou d'une manipulation incorrects, d'une usure naturelle, d'une mauvaise mise en place ou d'une mauvaise conservation, d'un raccordement ou d'une installation incorrects ainsi que d'un cas de force majeure ou autres influences extérieures sont exclus de la garantie. En cas de réclamations, nous nous réservons le droit de réparer, de remplacer les pièces défectueuses ou d'échanger l'appareil. Les composants remplacés ou les appareils échangés deviennent notre propriété. Les demandes de dommages et intérêts sont exclues tant qu'elles ne reposent pas sur l'intention ou une négligence grossière du fabricant.

Si votre appareil devait malgré tout présenter une défectuosité pendant la période de garantie, veuillez vous adresser, muni de la quittance d'achat, exclusivement au magasin où vous avez acheté votre appareil SWITEL. Vous ne pouvez faire valoir vos droits à la garantie selon ces dispositions qu'auprès de votre revendeur exclusivement. Deux ans après l'achat et la remise de nos produits, il n'est plus possible de faire valoir les droits à la garantie.

# Index

---

## 15 Index

### A

Affichage des numéros d'appel, 48  
Affichage du numéro d'appel, 55  
Alarme, 43  
Amplificateur sonore, 52  
Annulation, 53  
Annuler, 45  
Appeler, 50

### B

Base, 36, 54

### C

Caractéristiques techniques, 57  
Chargeur, 36  
Chercher, 53  
CLIP, 55  
Combiné, 53  
Communications internes, 51  
Composer des numéros, 50  
Conférences téléphoniques, 51  
Consignes de sécurité, 34  
Contenu de l'emballage, 35  
Créer, 41, 46

### D

Date, 37  
Déclaration, 53  
Déclaration de conformité, 58  
Déclarer, 45  
Durée de la communication, 52

### E

Écran, 40  
Effacer, 47, 49  
Élargissement, 53  
Éléments de manipulation, 38  
Emploi, 39  
Enregistrements dans le répertoire, 46  
Enregistrements du répertoire, 41  
Enregistrer, 46

### F

Fonctions, 54

### G

Garantie, 59

### H

Heure, 37  
Hotline de service, 55

### I

Icônes, 40  
 Icônes à l'écran, 40  
 Installations PABX, 54

### L

Langue de l'écran, 37  
Liste d'appels, 42, 48

## M

- Mélodie de la sonnerie d'appel, 43, 45
- Menu principal, 42
- Messages, 48
- Messages à l'écran, 48
- Mettre en place
  - les piles rechargeables, 37
- Mise du micro sur silencieux, 52
- Mise en service, 35
- Mise sur silencieux, 52
- Mode ÉCO, 38
- Mode mains-libres, 52
- Mode veille, 41
- Modifier, 47

## N

- Niveau de chargement des piles, 37
- Notations, 39
- Numérotation par impulsions, 45, 54
- Numérotation par tonalité, 45, 54

## P

- Paging, 53
- Pause de numérotation, 54
- Prise d'appel, 37, 50
- Problèmes, 55

## Q

- Questions et réponses, 56

## R

- Raccord du casque, 39
- Raccrocher, 50
- Rappel, 50
- Recharger, 37
- Réduction du rayonnement, 38
- Réglages usine, 44, 45, 58
- Remarques d'entretien, 59
- Répertoire, 42, 46, 50
- Répétition automatique
  - des derniers numéros, 43
- Répondeur dans
  - le réseau téléphonique, 55

## S

- Saisie de nom, 46
- Saisie de texte, 46
- Sauvegarder, 41, 49
- Sélection directe, 48, 51
- Services confort, 54
- Structure du menu, 42
- Suppression d'erreurs, 55
- Système de numérotation, 45, 54

## T

- Téléphoner, 50
- Terminer la communication, 50
- Touche de répétition automatique
  - des derniers numéros, 50
- Touche R, 54, 55
- Transfert, 51
- Transfert de communication, 51

## V

- Verrouillage du clavier, 53
- VMWI, 55
- Volume sonore de l'écouteur, 52

# Notes

---

## Notes

## Contenuto

---

1	Indicazioni di sicurezza . . . . .	64
2	Mettere in funzione il telefono . . . . .	65
3	Elementi di comando . . . . .	68
4	Informazioni introduttive . . . . .	69
5	Struttura dei menu . . . . .	72
6	Rubrica telefonica . . . . .	76
7	Elenco chiamate . . . . .	78
8	Compiere telefonate . . . . .	80
9	Ampliamento del sistema telefonico . . . . .	83
10	Funzioni speciali . . . . .	84
11	Impianti telefonici interni / Servizi addizionali	84
12	In presenza di problemi . . . . .	86
13	Specifiche tecniche . . . . .	87
14	Consigli per la cura / Garanzia . . . . .	89
15	Indice alfabetico . . . . .	90

# Indicazioni di sicurezza

## 1 Indicazioni di sicurezza

Leggere attentamente le presenti istruzioni per l'uso.

### Impiego conforme agli usi previsti

Il presente telefono consente di svolgere telefonate all'interno di una rete telefonica. Qualsiasi altro impiego è considerato come non conforme agli usi previsti. Non sono consentite modifiche o trasformazioni non autorizzate. Non aprire per nessuna ragione l'apparecchio autonomamente, né compiere riparazioni di propria iniziativa.

### Luogo di installazione

Evitare un'esposizione a fumo, polvere, vibrazioni, sostanze chimiche, umidità, calore e raggi solari diretti.

Non utilizzare l'unità portatile in aree esposte al rischio di deflagrazione.

### Alimentatore di rete



**Attenzione:** Utilizzare solo l'alimentatore a spina fornito in dotazione visto che altri alimentatori di rete potrebbero addirittura danneggiare il telefono. Non ostacolare il libero accesso all'alimentatore a spina con mobili o altri oggetti simili.

### Accumulatori ricaricabili



**Attenzione:** Non gettare gli accumulatori ricaricabili nel fuoco. Utilizzare solo accumulatori dello stesso tipo. Osservare la corretta polarità! Pericolo di esplosione durante il caricamento degli accumulatori in caso di errata polarità.

### Caduta di tensione

In caso di caduta di tensione non è possibile compiere chiamate con questo telefono. Si consiglia di ricorrere in caso di emergenza ad un telefono con filo in grado di funzionare anche senza alimentazione elettrica esterna.

### Apparecchiature mediche



**Attenzione:** Non utilizzare il telefono in prossimità di apparecchiature mediche. Non è infatti possibile escludere il rischio di possibili interferenze.

### Compatibilità con apparecchi acustici

Il telefono è compatibile con il maggior numero di apparecchi acustici presenti sul mercato. Ciò nonostante non è possibile garantire un perfetto funzionamento con qualsiasi tipo di apparecchio acustico.

**Telefoni DECT<sup>1</sup>** possono causare un fastidioso ronzio in apparecchi acustici.

<sup>1</sup> **DECT:** Digital Enhanced Cordless Telecommunication = Standard per telefoni senza cavo.



# Mettere in funzione il telefono

## Smaltimento

Procedere allo smaltimento dell'apparecchio esaurito consegnandolo presso uno dei punti di raccolta istituiti dalla propria società di smaltimento rifiuti comunale (ad es. centro di riciclo materiali). Il simbolo riportato qui a lato indica che non è assolutamente consentito smaltire l'apparecchio assieme ai normali rifiuti domestici! Secondo quanto previsto dalla legge sugli apparecchi elettrici ed elettronici, i proprietari di apparecchi esauriti sono per legge tenuti alla consegna di tutti gli **apparecchi elettrici ed elettronici** presso un centro di rilievo rifiuti in raccolta differenziata.



**Consegnare gli accumulatori** per lo smaltimento presso rivenditori al dettaglio di batterie o centri di raccolta che mettono a disposizione appositi contenitori.



Smaltire **confezioni ed imballaggi** in base a quanto indicato dalle norme in vigore a livello locale.

## 2 Mettere in funzione il telefono

### Indicazioni di sicurezza



**Attenzione:** Prima della messa in funzione, leggere attentamente le indicazioni di sicurezza riportate al capitolo 1.

### Verificare il contenuto della confezione

La confezione contiene:

Contenuto	Modello DC62x <sup>1</sup>			
	621	622	623	624
Stazione base con alimentatore di rete	1	1	1	1
Stazione di carica con alimentatore di rete	-	1	2	3
Unità portatile	1	2	3	4
Cavo di collegamento telefonico	1	1	1	1
Accumulatori	2	4	6	8
Istruzioni per l'uso	1	1	1	1

<sup>1</sup> Per ulteriori informazioni riguardo la disponibilità di questo telefono/set telefonico si prega di visitare il sito [www.switel.com](http://www.switel.com).

# Mettere in funzione il telefono

## Collegare la stazione base



**Attenzione:** Montare la stazione base con una distanza minima di 1 m da altri apparecchi elettronici in modo da evitare interferenze reciproche.

Procedere al collegamento della stazione base seguendo quanto raffigurato nella figura. Utilizzare per motivi di sicurezza solo l'alimentatore di rete oltre al cavo di collegamento telefonico fornito in dotazione.

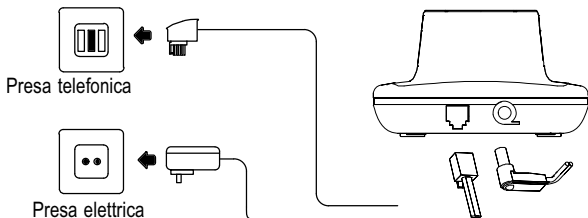

Utilizzare per la stazione base l'alimentatore di rete con il codice VD060025D (o BD060025D) e i dati di output 6 V, 250 mA.

## Collegare la stazione di carica<sup>1</sup>

Procedere al collegamento della stazione di carica seguendo la figura. Per motivi di sicurezza si prega di utilizzare soltanto l'alimentatore di rete fornito in dotazione.

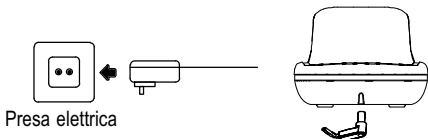

Utilizzare per la stazione di carica l'alimentatore di rete con il codice VD060015D (o BD060015D) e i dati di output 6 V, 150 mA.

<sup>1</sup> Vale solo per set telefonici con minimo due unità portatili  "Verificare il contenuto della confezione" a pagina 65.

# Mettere in funzione il telefono

## Inserire gli accumulatori

Inserire le batterie ricaricabili nel vano accumulatori precedentemente aperto. Utilizzare esclusivamente batterie ricaricabili di tipo AAA NiMH 1,2 V. Osservare la corretta polarità! Chiudere infine il vano accumulatori.

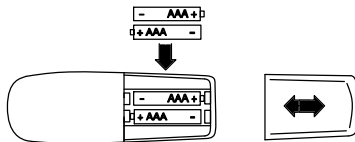

## Caricare gli accumulatori



Riporre l'unità portatile in sede di prima messa in funzione per **minimo** 16 ore nella stazione base / stazione di carica.

[Non appena il portatile è posizionato correttamente nella stazione base/stazione di carica, si avverte un segnale di avviso.] [Avendo posizionato l'unità portatile nella stazione base/stazione di carica in maniera corretta, la spia di controllo dello stato di carica è accesa.] L'unità portatile si surriscalda durante il processo di carica. Questo è un fenomeno normale e non pericoloso. Evitare di caricare l'unità portatile con dispositivi di carica differenti o estranei. Lo **stato di carica** attuale è visualizzato sul display:



Carico



Metà carico



Debole



Scarico

## Impostare la lingua di display

Selezionare la lingua che interessa (vedi anche "Struttura di menu"):

[<img alt="arrow icon" data-bbox="131 608 168 625"/>] > MOBILTEIL > SPRACHE >...

[<img alt="arrow icon" data-bbox="131 635 168 652"/>] > PORTATILE > LINGUA >...

È possibile scegliere tra le lingue tedesco, francese, italiano e inglese.

## Impostare data e ora dell'unità portatile

Una voce di menu consente di impostare data e ora. A pagina 73 è indicata la posizione da scorrere nel menu.

## Accettazione di chiamata automatica

L'attivazione di questa funzione consente di ricevere automaticamente una chiamata estraendo semplicemente l'unità portatile dalla stazione base. L'accettazione di chiamata automatica è attivata o disattivata nel menu. A pagina 74 è indicata la posizione da scorrere nel menu.

# Elementi di comando

## Impianti telefonici interni

A pagina 84 sono riportate ulteriori informazioni nel caso in cui si volesse collegare il telefono ad un impianto telefonico interno.

## Riduzione delle radiazioni (modalità ECO)

La radiazione in modalità di stand-by è stata considerevolmente ridotta se paragonata a quella emessa da telefoni cordless a standard DECT, con unità portatili nella base.



In modalità di conversazione le radiazioni sono ridotte in base alla distanza dell'unità portatile rispetto alla base.

## 3 Elementi di comando

I tasti del telefono riportati nel presente manuale d'istruzioni per l'uso sono raffigurati sotto forma di simboli uniformi all'interno di un riquadro. Sono possibili lievi scostamenti dei simboli dei tasti sul telefono rispetto ai simboli qui raffigurati.

### Unità portatile

- 1 Altoparlante
- 2 Display LCD
- 3 Tasto menu/Tasto OK
- 4 Tasto di selezione rapida M2
- 5 Collegamento per auricolare
- 6 Tasto cancella/Tasto R
- 7 Tasto di vivavoce
- 8 Tasti numerici
- 9 Tasto #/  
Blocco tastiera
- 10 Microfono
- 11 Tasto pausa
- 12 Tasto \*/  
Chiamate interne
- 13 Tasto conversazione/  
Tasto di riaggancio
- 14 Tasto freccia in basso/  
Elenco chiamate
- 15 Tasto di selezione rapida M1
- 16 Tasto freccia in alto/  
Ripetizione di chiamata
- 17 LED

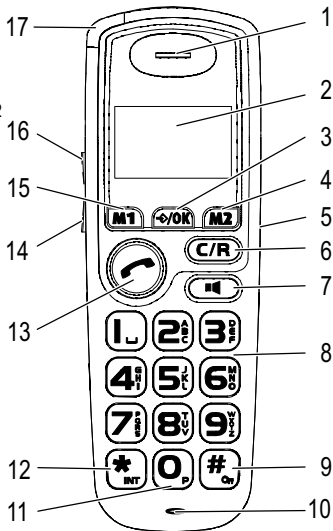

# Informazioni introduttive

## Presa di collegamento per auricolare

Sul lato destro dell'unità portatile si trova una presa per l'allacciamento di una cuffia auricolare. Si consiglia di utilizzare un auricolare con una presa jack stereo da 2,5 mm. Non si assume alcuna garanzia riguardo il rispettivo funzionamento.

## Stazione base

- 1 Contatti di carica
- 2 Tasto di paging
- 3 LED caricamento
- 4 LED stato di esercizio

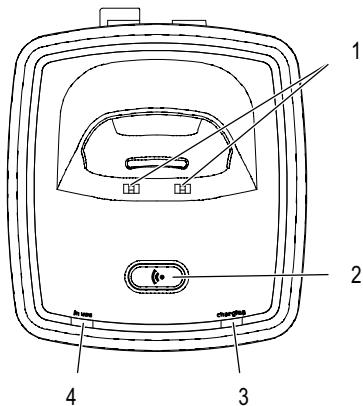

## 4 Informazioni introduttive







In questo capitolo sono riportate le principali informazioni riguardo l'uso delle presenti istruzioni e del telefono.

### Modi di rappresentazione nelle istruzioni per l'uso









Rappresentazione	Descrizione
	Rappresentazione dei tasti
	Premere brevemente il tasto raffigurato
2 sec.	Premere il tasto raffigurato per 2 secondi

<sup>1</sup> **VMWI: Visual Message Waiting Indication** = Segnalazione ottica di nuovi messaggi.

# Informazioni introduttive

	Inserire numeri o lettere
	Unità portatile squilla
	Estrarre l'unità portatile dalla stazione base
	Riporre l'unità portatile nella stazione base
	Rappresentazione di testi sul display
	Rappresentazione di simboli sul display

## Simboli e testi sul display dell'unità portatile

Simbolo	Descrizione
	Costante: Indicazione dello stato di carica delle batterie. Lampeggiante: Caricare gli accumulatori. Segmenti che scorrono: Gli accumulatori sono in fase di ricarica ☞ pagina 67.
1	Numero di chiamata interno dell'unità portatile ☞ pagina 83.
12--59	Visualizzazione dell'ora ☞ pagina 73.
	Condurre una chiamata ☞ pagina 80.
	Ci si trova nell'elenco chiamate. Presenza di nuove chiamate nell'elenco chiamate ☞ pagina 78.
	La segnalazione acustica di chiamata è disinserita ☞ pagina 73.
	La funzione vivavoce è attivata ☞ pagina 82.
	Il blocco tastiera è attivato ☞ pagina 83.
	La funzione di allarme è attivata.
ATTENDERE	Segreteria telefonica integrata nella rete telefonica. <b>VMWI</b> <sup>1</sup> - Servizio aggiuntivo del proprio gestore di rete telefonica ☞ pagina 85.
	Collegamento con la stazione base è buono.











# Informazioni introduttive

## Modalità di stand-by

In tutte le descrizioni del presente manuale di istruzioni si considera l'unità portatile in modalità di stand-by. L'unità portatile passa alla modalità di stand-by nel momento in cui non si svolge alcuna chiamata e con menu chiusi. Premere se occorre ripetutamente il tasto **C** per passare alla modalità di stand-by.

## Navigazione nel menu

I differenti menu consentono di raggiungere tutte le funzioni del telefono. Il percorso da seguire per giungere alla funzione desiderata è indicata dalla struttura di menu  pagina 72.





	Aprire il menu principale
 o 	Selezionare il sottomenu desiderato
	Aprire il sottomenu
 o 	Selezionare la funzione desiderata
	Aprire la funzione
 o 	Selezionare l'impostazione desiderata
	La tastiera consente di inserire numeri o lettere
	Confermare le immissioni
<b>C</b>	Tornare indietro di un livello
premere ripetutamente <b>C</b>	Interrompere procedure di programmazione e memorizzazione e ripassare alla modalità di stand-by



Ogni singolo processo si interrompe automaticamente se entro 15 secondi non si procede con una immissione.

## Creare voci nella rubrica telefonica - Esempio

La navigazione nei menu e la procedura da seguire per compiere impostazioni è indicata a titolo esemplificativo in **Creare voci nella rubrica telefonica**. Si consiglia di seguire quanto riportato nell'esempio per tutte le impostazioni che si desiderano compiere.

	Aprire il menu principale
RUBRICA 	Aprire la rubrica telefonica
	Saltare la selezione di voci
AGGIUNGI 	Selezionare un sottomenu e confermare

# Struttura dei menu



Immettere un nome (max. 12 segni) e confermare



Immettere un numero di chiamata (max. 24 cifre) e confermare

## 5 Struttura dei menu

### Menu principale

Per passare al menu principale, premere il tasto . Selezionare quindi una voce con i tasti o e confermare la scelta con il tasto .

Maggiori informazioni su menu ed esercizio capitolo 4.

RUBRICA, selezionare /, saltare una voce

AGGIUNGI	NOME	NUMERO
MODIFICA	NOME	NUMERO
CANCELLA	CONFERMA?	
CANCELLA TUTTO	CONFERMA?	

CHIAMATE<sup>2</sup>, selezionare /, saltare una voce

SALVA IN RUBRICA	NOME	NUMERO
CANCELLA	CONFERMA?	
CANCELLA TUTTO	CONFERMA?	

<sup>1</sup> I tasti numerici riportano altresì delle lettere. Premendo ripetutamente il relativo tasto si ha modo di selezionare lettere, cifre e caratteri speciali.



<sup>2</sup> Per visualizzare e memorizzare numeri di chiamata in elenchi chiamate è necessaria la visualizzazione del numero di chiamata (**CLIP**<sup>3</sup>). La visualizzazione del numero di chiamata è un servizio aggiuntivo offerto dal proprio gestore di rete telefonica. Si consiglia di rivolgersi al proprio gestore di rete telefonica per ricevere ulteriori informazioni a riguardo. Per ulteriori informazioni sulla visualizzazione del numero di chiamata vedi pagina 78.

<sup>3</sup> **CLIP**: Calling Line Identification Presentation = Visualizzazione del numero telefonico del chiamante.





# Struttura dei menu











RIPETI, selezionare / , saltare una voce 

SALVA IN RUBRICA	NOME 	NUMERO 
CANCELLA	CONFERMA?	
CANCELLA TUTTO	CONFERMA?	

## SVEGLIA



SVEGLIA 1	ANNULLA		
	IMPOSTA	ORA 	CONFERMA?
SVEGLIA 2	ANNULLA		
	IMPOSTA	ORA 	CONFERMA?

## PORTATILE

MELODIA	MELODIA EST	MELODIA 1-10
	MELODIA INT	MELODIA 1-10
VOL.SUONERIA	VOLUME 1-5, OFF	
IMPOSTA	DATA/ORA	DATA  
		 CONFERMA?
		ORA  
		 CONFERMA?
	FORMATO	DATA  
		 GG/MM
		 MM/GG

# Struttura dei menu



---

↖		ORA  ↘
		↘ 12 H
		↘ 24 H
AMPLIFICATO	ON	BASSO
		MEDIO
		ALTO
	AUTO	
	OFF	
TONI	ON/OFF	
CONTRASTO	LIVELLO 1-8	
NOME DEL TELEFONO		
ILLUMINAZ.	5-30 SECONDI	
RISPOSTA AUTO	ON/OFF	
LINGUA <sup>1</sup>		
RESET	CONFERMA?	



<sup>1</sup>Le lingue disponibili sono riportate nel  capitolo 2.

# Struttura dei menu

IMPOSTA BASE, PIN: <sup>1</sup>

MELODIA BASE	MELODIA 1-5	
VOL.SUONERIA	VOLUME 1-5, OFF	
MODIFICA PIN <sup>1</sup>	NUOVO PIN 	CONFERMA PIN 
SELEZIONE	TONI	
	IMPULSI	
FLASH	BREVE	
	MEDIO	
	LUNGO	
VMWI <sup>2</sup>	VMWI SPENTO?	
RESET	CONFERMA?	

AFFILIAZIONE

REGISTRA	PIN: 	
SELEZIONA BASE	BASE 1-4	
DEREGISTRA	PIN: 	PORTATILE1-4
DEREGISTRA	BASE 1-4	

<sup>1</sup> Il codice PIN è impostato in fabbrica su "0000".

<sup>2</sup> **VMWI**: **V**isual **M**essage **W**aiting **I**ndication = Visualizzazione ottica per messaggi nuovi.

# Rubrica telefonica





## 6 Rubrica telefonica

Nella rubrica telefonica è possibile memorizzare 100 numeri di chiamata con rispettivi nomi.

- Assegnare a tutti i numeri di chiamata sempre un prefisso in modo da poter riconoscere anche una chiamata urbana in arrivo ed abbinarla ad una voce presente nella rubrica telefonica.
- Con capacità di memoria esaurita, sul display è visualizzata l'indicazione  dopo aver memorizzato l'ultimo messaggio. Per poter disporre di nuovo spazio memoria, cancellare prima una voce già presente.
- Le voci della rubrica telefonica sono elencate in ordine alfabetico.

### Immettere nomi









I tasti numerici riportano altresì delle lettere. Premendo ripetutamente il relativo tasto si ha modo di selezionare lettere, cifre e caratteri speciali.

	Immettere spazi vuoti
	Cancellare
 o 	Muovere il cursore



Per immettere la stessa lettera una seconda volta, premere il rispettivo tasto. Attendere fino a quando il cursore si sia spostato di una posizione. Immettere quindi la lettera una seconda volta.

### Creare voci nella rubrica telefonica

	Aprire il menu principale
RUBRICA 	Aprire la rubrica telefonica
	Saltare la selezione di voci
AGGIUNGI 	Selezionare un sottomenu e confermare
 	Immettere un nome (max. 12 segni) e confermare
 	Immettere un numero di chiamata (max. 24 cifre) e confermare

# Rubrica telefonica

## Modificare voci nella rubrica telefonica

	Aprire il menu principale
RUBRICA	Aprire la rubrica telefonica
o	Selezionare la voce e confermare
o MODIFICA	Selezionare un sottomenu e confermare
	Modificare il nome e confermare
	Modificare il numero di chiamata e confermare

## Cancellare voci nella rubrica telefonica

### Cancellare una voce

	Aprire il menu principale
RUBRICA	Aprire la rubrica telefonica
o	Selezionare la voce e confermare
o CANCELLA	Selezionare un sottomenu e confermare
CONFERMA?  o <b>C</b>	Confermare o interrompere la procedura di cancellazione

### Cancellare tutte le voci

	Aprire il menu principale
RUBRICA	Aprire la rubrica telefonica
	Saltare la selezione di voci
o CANCELLA TUTTO	Selezionare un sottomenu e confermare
CONFERMA?  o <b>C</b>	Confermare o interrompere la procedura di cancellazione

# Elenco chiamate

## Selezione diretta

È possibile memorizzare 1 numero di chiamata come numero di selezione diretta rispettivamente sui tasti **M1** e **M2**.

Memorizzare numeri di chiamata come numeri di selezione diretta

Immettere un numero o selezionare una voce dalla rubrica telefonica, dall'elenco di ripetizione di chiamata o dall'elenco chiamate.

3 sec. **M1** o **M2**

La selezione è salvata sul rispettivo tasto di selezione diretta



Le voci salvate come tasti di selezione diretta non possono essere cancellati bensì soltanto sovrascritti.

## 7 Elenco chiamate

All'interno dell'elenco chiamate è possibile memorizzare in tutto 20 numeri telefonici.



La visualizzazione del numero di chiamata (**CLIP**<sup>1</sup>) è un servizio aggiuntivo del proprio gestore di rete telefonica. Nel caso in cui il gestore della rete telefonica supporti il servizio, sul display del telefono è visualizzato il numero di chiamata. Per maggiori dettagli a riguardo, rivolgersi al proprio gestore di rete telefonica.

Messaggi sul display:

FUORI AREA	Il numero di chiamata è stato ricevuto solo in parte o non correttamente.
INTERNAZ.	L'informazione relativa al numero di chiamata non è disponibile. Si potrebbe anche trattare di una chiamata internazionale.
RISERVATO	Il chiamante ha disattivato la trasmissione del proprio numero di chiamata.

## Visualizzare numeri di chiamata dall'elenco chiamate



Aprire l'elenco chiamate e selezionare una voce











Premere se occorre ripetutamente il tasto **\*** per scorrere nel display tra le voci "Nome", "Numero" e "Data/Orario di ricezione".

<sup>1</sup> **CLIP**: Calling Line Identification Presentation = Visualizzazione del numero telefonico del chiamante.

# Elenco chiamate

## Memorizzare nella rubrica un numero di chiamata dall'elenco chiamate

È possibile memorizzare un numero di chiamata direttamente dall'elenco chiamate nella rubrica telefonica.









 ,  o 	Aprire l'elenco chiamate e selezionare una voce
	Aprire il menu
 o  , SALVA IN RUBRICA, 	Selezionare il sottomenu e confermare
 , 	Immettere un nome (max. 12 segni) e confermare
 , 	Modificare il numero di chiamata e confermare









Non appena al numero di chiamata nella rubrica telefonica è assegnato un nome, nell'elenco chiamate è visualizzato il nome inserito.

## Cancellare numeri di chiamata dall'elenco chiamate

Cancellare singoli numeri di chiamata

 ,  o 	Aprire l'elenco chiamate e selezionare una voce
	Aprire il menu
 o  , CANCELLA, 	Selezionare un sottomenu e confermare
CONFERMA?,  o 	Confermare o interrompere la procedura di cancellazione

Cancellare tutti i numeri di chiamata

	Aprire l'elenco chiamate
	Aprire il menu
 o  , CANCELLA TUTTO, 	Selezionare un sottomenu e confermare
CONFERMA?,  o 	Confermare o interrompere la procedura di cancellazione

# Compiere telefonate

## 8 Compiere telefonate

### Accettare una chiamata



Ricevere una chiamata

### Concludere una chiamata



Concludere una chiamata

### Compiere telefonate



Immettere un numero di chiamata (max. 24 cifre)



In caso di immissione errata, cancellare l'ultima cifra



Selezionare il numero di chiamata



È altresì possibile premere prima il tasto  e ottenere quindi il segnale di linea libera. Le cifre immesse per la composizione del numero di chiamata desiderato sono immediatamente selezionate. Nel corso di una simile chiamata non è possibile eseguire la correzione di singole cifre che compongono il numero di chiamata.

### Ripetizione di chiamata

Il telefono memorizza i 10 ultimi numeri di chiamata selezionati all'interno di un elenco di ripetizione di chiamata.



Aprire l'elenco di ripetizione di chiamata e selezionare una voce



Instaurare un collegamento

La modifica di numeri di chiamata presenti nell'elenco di ripetizione di chiamata è identica alla modifica descritta per i numeri di chiamata nell'elenco chiamate

☞ capitolo 7.

### Richiamare una telefonata ricevuta

Il telefono memorizza 20 numeri telefonici in un elenco chiamate.



Aprire l'elenco chiamate e selezionare una voce



Instaurare un collegamento

### Selezionare numeri di chiamata dalla rubrica telefonica

I numeri di chiamata devono risultare memorizzati nella rubrica telefonica

☞ capitolo 6.



Aprire il menu principale



# Compiere telefonate

RUBRICA		Aprire la rubrica telefonica
o		Selezionare una voce, instaurare un collegamento

## Selezione diretta

I numeri di chiamata devono risultare memorizzati come numeri di chiamata diretta capitolo 5.

3 sec. <b>M1</b> o <b>M2</b>	Eseguire la selezione diretta
------------------------------	-------------------------------

## Compiere chiamate interne<sup>1</sup>

Condurre chiamate interne

Per condurre telefonate interne gratuite bisogna aver registrato due o più unità portatili (UP1, UP2, ...) presso la stazione base.

UP1: 3 sec. <b>INT</b>	Avviare una chiamata interna
ad es. <b>2</b> <sup>ABC</sup>	Selezionare il numero di chiamata interno del portatile desiderato
UP2:	Accettare una telefonata interna presso l'altra unità portatile
UP1 / UP2:	Concludere la telefonata interna

Trasferire internamente chiamate esterne

UP1: 3 sec. <b>INT</b>	Con chiamata esterna in corso
ad es. <b>2</b> <sup>ABC</sup>	Selezionare un numero di chiamata interno
UP2:	Accettare una telefonata interna presso l'altra unità portatile
UP1:	Trasferire la chiamata



Nel caso in cui il portatile chiamato non dovesse rispondere, trascorsi 30 sec. la telefonata è di nuovo trasferita al portatile chiamante.

Condurre chiamate a conferenza

Questa funzione consente di condurre una conferenza con una chiamata esterna ed un altro interlocutore interno.

UP1: 3 sec. <b>INT</b>	Con chiamata esterna in corso
ad es. <b>2</b> <sup>ABC</sup>	Selezionare un numero di chiamata interno

<sup>1</sup> Per compiere telefonate interne sono necessarie minimo due unità portatili "Verificare il contenuto della confezione" a pagina 65.

# Compiere telefonate

UP2: 

Accettare una telefonata interna presso l'altra unità portatile

UP1: 3 sec. 

Avviare la chiamata in conferenza

UP1 / UP2: 

Concludere la chiamata in conferenza

## Impostare il volume del ricevitore

Il volume è regolabile durante lo svolgimento di una chiamata in 5 livelli.



Selezionare il volume desiderato

## Amplificazione acustica

Oltre ai 5 livelli di volume è possibile prevedere un'ulteriore amplificazione acustica del parlato  capitolo 5. Attivare la rispettiva amplificazione per poter usufruire della funzione.

AMPLIFICATO	Funzione
OFF	Possibile selezionare soltanto volume 1-5
ON, BASSO	Possibile selezionare in più un'amplificazione bassa
ON, MEDIO	Possibile selezionare in più un'amplificazione bassa e media
ON, ALTO	Possibile selezionare in più un'amplificazione bassa, media e alta
AUTO	Premendo 2 sec.  l'apparecchio applica automaticamente l'amplificazione più alta.

## Visualizzazione della durata di conversazione

Durante lo svolgimento di una chiamata, la durata della conversazione è visualizzata in ore, minuti e secondi sul display.

## Funzione vivavoce

Utilizzare questa funzione per ascoltare il partner di chiamata attraverso l'altoparlante.



Attivare la funzione vivavoce



Disattivare la funzione vivavoce

## Silenziamento del microfono nell'unità portatile

È possibile attivare e disattivare il microfono dell'unità portatile con chiamata telefonica in corso.

3 sec. 

Disattivare il microfono (silenziamento)

3 sec. 

Attivare il microfono

# Ampliamento del sistema telefonico

## Blocco tastiera

Il blocco tastiera aiuta ad impedire l'attivazione inavvertita di determinate funzioni.

3 sec. 

Attivare il blocco tastiera



L'attivazione del blocco tastiera consente di ricevere telefonate in arrivo come di consueto.

3 sec. 

Disattivare il blocco tastiera

## Cercare l'unità portatile (funzione di paging)

Avendo perso d'occhio la propria unità portatile è possibile ritrovarla facilmente grazie all'emissione di un tono di ricerca.

Presso la base , 

Avviare il tono di ricerca

 o 

Interrompere il tono di ricerca

## 9 Ampliamento del sistema telefonico

Lo standard internazionale **GAP**<sup>1</sup> regola la compatibilità di unità portatili e stazioni base di costruttori differenti. In tal modo è possibile adoperare apparecchi **SWITEL** in combinazione con apparecchi di altri costruttori all'interno di un unico sistema telefonico. Può comunque anche verificarsi la mancata disponibilità di alcune funzioni.

### Maggior numero di unità portatili



È possibile registrare complessivamente fino a 5 unità portatili presso la propria stazione base.

### Registrazione di unità portatili

Prima di registrare un'unità portatile, passare con la stazione base alla modalità di registrazione.

15 sec. 

Avviare la modalità di registrazione

Registrare quindi l'unità portatile  capitolo 5. Utilizzare ai fini della registrazione il codice PIN attualmente impostato  capitolo 5.

Una volta eseguita la selezione, all'unità portatile è assegnato un numero di chiamata interno. Questo numero di chiamata interno è visualizzato sul display.



Per registrare unità portatili di altri costruttori, leggere prima le rispettive istruzioni per l'uso.

<sup>1</sup> **GAP: Generic Access Profile** = Standard per l'interazione di unità portatili e stazioni base di altri costruttori.

# Funzioni speciali

## Deregistrazione di unità portatili



La deregistrazione di un'unità portatile da una stazione base è possibile solo attraverso un'altra unità portatile registrata a sua volta alla stazione base in questione.

Unità portatili sono deregistrate tramite menu. Nel capitolo 5 è possibile individuare la posizione nel menu.

## Maggior numero di stazioni base

La portata della propria unità portatile può essere aumentata registrando l'apparecchio ad un numero maggiore di stazioni base. È possibile registrarsi contemporaneamente presso 4 stazioni base differenti. Ogni stazione base necessita di una propria presa telefonica. Si può trattare di allacciamenti con lo stesso o differente numero di chiamata.



Per chiamate in corso non è invece possibile compiere un trasferimento da una stazione base all'altra.

## 10 Funzioni speciali

### Procedura di selezione

Il presente telefono funziona sia all'interno di sistemi telefonici analogici (procedura di selezione a impulsi), sia se integrato in moderni sistemi telefonici digitali (procedura di selezione a toni). La procedura di selezione è impostata tramite menu. Nel capitolo 5 è possibile individuare la posizione nel menu.

## 11 Impianti telefonici interni / Servizi aggiuntivi

### Tasto R in impianti telefonici interni

Avendo collegato il telefono ad un impianto telefonico interno, il **tasto R** consente di accedere a tutte le altre funzioni disponibili come per es. trasferimento di chiamata e funzione di richiamata automatica. Si prega di consultare le istruzioni per l'uso del proprio impianto telefonico interno per individuare il tempo flash da impostare al fine di poter usufruire di queste funzioni. Il rivenditore autorizzato è in grado di indicare se il telefono acquistato funzionerà senza alcun problema nel proprio impianto telefonico interno. Il tempo flash è impostato tramite menu. Nel capitolo 5 è possibile individuare la posizione nel menu.

### Pausa di selezione

In presenza di impianti telefonici interni è necessario preselezionare un numero di accesso alla rete esterna per ottenere un segnale di linea libera prima di poter compiere una telefonata. Alcuni impianti telefonici interni di vecchia data richiedono del tempo prima di trasmettere il segnale di libero. Per questi impianti telefonici interni è possibile inserire una pausa di selezione dopo il numero di accesso alla linea esterna in modo da poter proseguire con la selezione del numero senza dover attendere il segnale di libero. La pausa di selezione è inserita premendo il tasto **P** e tenendolo premuto per 3 sec.

# Impianti telefonici interni / Servizi aggiuntionali

Dopo il numero di accesso alla rete esterna si procede, trascorso un determinato intervallo di tempo, con la selezione del numero di chiamata vero e proprio.



La pausa di selezione è memorizzabile anche in sede di immissione di numeri di chiamata nella rubrica telefonica.

## Tasto R e servizi aggiuntionali

Il telefono supporta servizi aggiuntionali messi a disposizione dal proprio gestore di rete telefonica come ad es. le funzioni di chiamata in attesa, avviso di chiamata e chiamata a conferenza. Il **tasto R** consente di accedere a questi servizi aggiuntionali. Si prega di consultare il proprio gestore di rete telefonica per ottenere informazioni sul tempo flash necessario all'utilizzo dei servizi aggiuntionali. Rivolgersi al proprio gestore di rete telefonica per ottenere l'abilitazione ai servizi aggiuntionali. Il tempo flash è impostato tramite menu. Nel capitolo 5 è possibile individuare la posizione nel menu.

## Visualizzazione del numero di chiamata (CLIP<sup>1</sup>)



La visualizzazione del numero di chiamata è un servizio aggiuntionale offerto dal proprio gestore di rete telefonica. Si consiglia di rivolgersi al proprio gestore di rete telefonica per ricevere ulteriori informazioni a riguardo.

A condizione che il collegamento telefonico disponga di questa funzione, l'apparecchio visualizza il numero telefonico del chiamante non appena il telefono squilla. Nel caso in cui il chiamante abbia soppresso la trasmissione del proprio numero di chiamata, appare un'apposita indicazione. Se il numero di chiamata non è visualizzabile, questo non sarà memorizzato nell'elenco chiamate.

## Segreteria telefonica integrata nella rete telefonica

Sono numerosi i gestori di rete telefonica che offrono come servizio aggiuntionale una segreteria telefonica integrata nella stessa rete. Se il proprio gestore di rete telefonica mette a disposizione una segreteria telefonica all'interno della propria rete telefonica, un simbolo informa sulla presenza di nuovi messaggi (**VMWI**<sup>2</sup>). Questa funzione è disponibile solo nel caso di abilitazione al servizio da parte del gestore di rete telefonica. Per maggiori dettagli a riguardo, rivolgersi al proprio gestore di rete telefonica.

La visualizzazione del simbolo di nuovi messaggi è altresì disattivabile. Vedi capitolo 5, VMWI SPENTO?.

<sup>1</sup> **CLIP**: Calling Line Identification Presentation = Visualizzazione del numero telefonico del chiamante.

<sup>2</sup> **VMWI**: Visual Message Waiting Indication = Segnalazione ottica di nuovi messaggi.

# In presenza di problemi

## 12 In presenza di problemi

### Hotline di assistenza tecnica

In presenza di problemi con il telefono, seguire le indicazioni riportate qui di seguito. In caso di problemi tecnici è possibile rivolgersi alla nostra hotline di assistenza tecnica chiamando al numero 0900 00 1675 valido per la Svizzera (spese da rete Swisscom alla data di stampa: CHF 2,60/min). In caso di reclami entro il periodo di garanzia, rivolgersi al rivenditore autorizzato. Il periodo di garanzia ricopre 2 anni.

### Domande e risposte

Domande	Risposte
Non è possibile condurre una chiamata telefonica	<ul style="list-style-type: none"><li>- Il telefono non è collegato correttamente oppure presenta un guasto. Utilizzare esclusivamente il cavo di collegamento telefonico fornito.</li><li>- Provare con un altro telefono se l'allacciamento telefonico in questione è funzionante.</li><li>- L'alimentatore di rete non è inserito oppure si è in presenza di una caduta di tensione totale.</li><li>- Le batterie ricaricabili sono scariche o difettose.</li><li>- La distanza dalla stazione base è troppo grande.</li><li>- Procedura di selezione non impostata correttamente ☞ pagina 75.</li></ul>
Non è possibile instaurare un collegamento con la stazione base	<ul style="list-style-type: none"><li>- Verificare se la registrazione alla stazione base è stata eseguita con il codice PIN corretto ☞ pagina 75.</li></ul>
Collegamento disturbato, interrotto	<ul style="list-style-type: none"><li>- La distanza dalla stazione base è troppo grande.</li><li>- Luogo di installazione della stazione base errato.</li></ul>
Il sistema non reagisce più	<ul style="list-style-type: none"><li>- Ripristinare la configurazione iniziale per tutte le funzioni ☞ pagina 74/75.</li><li>- Estrarre brevemente l'alimentatore di rete dalla presa di corrente.</li></ul>

## Specifiche tecniche

Le batterie ricaricabili si scaricano piuttosto subito.	<ul style="list-style-type: none"><li>- Le batterie ricaricabili sono scariche o difettose.</li><li>- Riporre l'unità portatile correttamente nella stazione base. Pulire le superfici di contatto su unità portatile e stazione base con un panno morbido e asciutto.</li><li>- Posizionare l'unità portatile per la durata di 16 ore nella stazione base.</li></ul>
La visualizzazione del numero di chiamata (CLIP <sup>1</sup> ) non funziona	<ul style="list-style-type: none"><li>- La visualizzazione del numero di chiamata è un servizio aggiuntivo offerto dal proprio gestore di rete telefonica. Per maggiori dettagli a riguardo, rivolgersi al proprio gestore di rete telefonica.</li><li>- Il chiamante ha disattivato la trasmissione del proprio numero di chiamata.</li></ul>

### 13 Specifiche tecniche

#### Specifiche tecniche

Caratteristica	Valore
Standard	<b>DECT1-GAP<sup>2</sup></b>
Alimentazione elettrica (stazione base)	Ingresso: 220/230 V, 50 Hz Uscita: 6 V, 250 mA
Alimentazione elettrica (stazione di carica)	Ingresso: 220/230 V, 50 Hz Uscita: 6 V, 150 mA
Portata	Esterno: ca. 300 m Interno: ca. 50 m
Durata di stand-by	fino a 100 ore
Max. autonomia di chiamata	fino a 10 ore
Accumulatori ricaricabili	2 x AAA NiMH 1.2 V

<sup>1</sup> **DECT**: Digital Enhanced Cordless Telecommunication = Standard per telefoni senza cavo.

<sup>2</sup> **GAP**: Generic Access Profile = Standard per l'interazione di unità portatili e stazioni base di altri costruttori.

# Specifiche tecniche

Procedura di selezione	Selezione a toni Selezione a impulsi
Temperatura ambiente ammessa	da 10 °C a 30 °C
Umidità dell'aria relativa ammessa	da 20% a 75%
Funzione flash	100 ms, 300 ms, 600 ms

## Configurazione iniziale

### Unità portatile

La configurazione iniziale è ripristinata nel menu. A pagina 74 è indicata la posizione da scorrere nel menu.

LINGUA = DEUTSCH	RUBRICA= vuoto
CHIAMATE = vuoto	RIPETI = vuoto
M1, M2 = vuoto	SVEGLIA 1/2 = OFF
MELODIA EST = 1	MELODIA INT = 2
VOL.SUONERIA = 3	RISPOSTA AUTO = ON
AMPLIFICATO = AUTO	
ILLUMINAZ. = 10 sec.	

### Stazione base

La configurazione iniziale è ripristinata nel menu. A pagina 75 è indicata la posizione da scorrere nel menu.

MELODIA BASE = 2	VOL.SUONERIA = 1
SELEZIONE = TONI	PIN = 0000

## Dichiarazione di conformità

Questo apparecchio risponde a quanto disposto dalla Direttiva UE 1999/5/CE concernente le apparecchiature radio, le apparecchiature terminali di telecomunicazioni e il reciproco riconoscimento della loro conformità. La conformità con la Direttiva di cui sopra viene confermata dal marchio CE applicato sull'apparecchio.

Per la dichiarazione di conformità completa si prega di voler usufruire del servizio gratuito di download dal nostro sito Internet [www.switel.com](http://www.switel.com).





## 14 Consigli per la cura / Garanzia

### Consigli per la cura

- Pulire le superfici degli apparecchi con un panno morbido e antipilling.
- Non utilizzare mai detersivi o solventi.

### Garanzia

Gli apparecchi SWITEL sono costruiti e collaudati in osservanza dei processi di produzione più moderni. L'impiego di materiali selezionati e tecnologie altamente sviluppate sono garanti di una perfetta funzionalità e lunga durata in vita. La garanzia non viene considerata esecutiva qualora la causa del malfunzionamento dell'apparecchio sia riconducibile al gestore della rete telefonica oppure se questa è da attribuirsi ad un impianto telefonico interno interposto. La garanzia non si estende a batterie, accumulatori o batterie ricaricabili utilizzati all'interno degli apparecchi. Il periodo di garanzia ricopre 24 mesi a partire dalla data di acquisto.

Entro il periodo di garanzia si procederà all'eliminazione gratuita di tutti i guasti dovuti a difetti di materiale o produzione. Il diritto di garanzia cessa in caso di interventi da parte dell'acquirente o di terzi. Danni derivanti da un impiego o esercizio non conforme agli usi previsti, a naturale usura, a errato montaggio o errata conservazione, a collegamento o installazione impropri, dovuti a forza maggiore o ad altri influssi esterni non sono coperti da garanzia. In qualità di produttore ci riserviamo il diritto, in caso di reclami, di riparare o sostituire le parti difettose o di rimpiazzare l'apparecchio. Parti o apparecchi sostituiti passano di nostra proprietà. Sono esclusi diritti di risarcimento per danni qualora non siano dovuti a intenzione o colpa grave del costruttore.

Nel caso in cui il presente apparecchio dovesse ciò nonostante presentare un difetto durante il periodo di garanzia, si prega di rivolgersi esclusivamente al negozio di rivendita dell'apparecchio SWITEL assieme al relativo scontrino di acquisto. In base alle presenti disposizioni, tutti i diritti di garanzia dovranno essere fatti valere esclusivamente nei confronti del rivenditore autorizzato. Decorso il termine di due anni dalla data di acquisto e consegna dei nostri prodotti non sarà più possibile fare valere alcun diritto di garanzia.

# Indice alfabetico

---

## 15 Indice alfabetico

### A

Accettazione di chiamata, 67, 80  
Agganciare il ricevitore, 80  
Ampliamento, 83  
Amplificazione acustica, 82

### B

Blocco tastiera, 83

### C

Cancellare, 77, 79  
Caricare, 67  
Cercare, 83  
Chiamate a conferenza, 81  
Chiamate interne, 81  
CLIP, 85  
Compiere telefonate, 80  
Concludere una chiamata, 80  
Configurazione iniziale, 74, 75, 88  
Consigli per la cura, 89  
Contenuto della confezione, 65  
Creare, 71, 76

### D

Data, 67  
Deregistrare, 75  
Deregistrazione, 84  
Dichiarazione di conformità, 88  
Display, 70  
Domande e risposte, 86  
Durata di conversazione, 82

### E

Elementi di comando, 68  
Elenco chiamate, 72, 78  
Eliminare guasti, 86  
Esercizio, 69

### F

Funzione di richiamata, 80  
Funzione vivavoce, 82  
Funzioni, 84

### G

Garanzia, 89

### H

Hotline di assistenza tecnica, 86

### I

Immissione di un nome, 76  
Immissione di un testo, 76  
Impianti telefonici interni, 84  
Indicazioni di sicurezza, 64  
Inserire gli accumulatori, 67

### L

Lingua di display, 67

# Indice alfabetico

---

## M

Melodia di suoneria, 73, 75  
Memorizzare, 79  
Menu principale, 72  
Messa in funzione, 65  
Messaggi, 78  
Messaggi di display, 78  
Modalità di stand-by, 71  
Modalità ECO, 68  
Modi di scrittura, 69  
Modificare, 77

## O

Ora, 67

## P

Paging, 83  
Pausa di selezione, 84  
Presenza di collegamento per auricolare, 69  
Problemi, 86  
Procedura di selezione, 75, 84

## R

Registrare, 75  
Registrazione, 83  
Riduzione delle radiazioni, 68  
Ripetizione di chiamata, 73, 80  
Rubrica telefonica, 72, 76, 80

## S

Salvare, 71, 76  
Segreteria telefonica integrata  
nella rete telefonica, 85  
Selezionare, 80  
Selezione a impulsi, 75, 84  
Selezione a toni, 75, 84  
Selezione diretta, 78, 81  
Servizi aggiuntivi, 84  
Silenziamiento, 82  
Silenziamiento del microfono, 82  
Simboli, 70  
Simboli di display, 70  
Specifiche tecniche, 87  
Stato di carica delle batterie ricaricabili, 67  
Stazione base, 66, 84  
Stazione di carica, 66  
Struttura dei menu, 72  
Sveglia, 73

## T

Tasto R, 84, 85  
Trasferimento di chiamata, 81

## U

Unità portatile, 83

## V

Visualizzazione del numero  
di chiamata, 78, 85  
VMWI, 85  
Voci della rubrica telefonica, 71  
Voci nella rubrica telefonica, 76  
Volume del ricevitore, 82



## Contents

---

1	Safety Information . . . . .	94
2	Preparing the Telephone . . . . .	95
3	Operating Elements . . . . .	98
4	Preliminary Information . . . . .	99
5	Menu Structure . . . . .	102
6	Phone Book . . . . .	106
7	Call Log . . . . .	108
8	Telephoning . . . . .	110
9	Extending the Telephone System . . . . .	113
10	Special Functions . . . . .	114
11	PABX / Supplementary Services . . . . .	114
12	In Case of Problems . . . . .	115
13	Technical Properties . . . . .	117
14	Maintenance / Guarantee . . . . .	119
15	Index . . . . .	120

# Safety Information

---

## 1 Safety Information

Please read this operating instruction manual thoroughly.

### Intended use

The telephone is suitable for telephoning within a public telephone network system. Any other use is considered unintended use. Unauthorised modification or reconstruction is not permitted. Under no circumstances open the device or complete any repair work yourself.

### Installation location

Prevent excessive exposure to smoke, dust, vibration, chemicals, moisture, heat and direct sunlight.

Do not use the handset in potentially explosive areas.

### Power adapter plug



**Attention:** Only use the power adapter plug supplied because other power supplies could damage the telephone. Ensure access to the power adapter plug is not obstructed by furniture or such.

### Rechargeable batteries



**Attention:** Never throw batteries into a fire. Only use batteries of the same type. Pay attention to correct polarity. Incorrect polarity of the batteries represents a risk of explosion during charging.

### Power failure

The telephone cannot be used to make calls in the event of a power failure. Always keep a cord connected telephone which operates without an external power supply available in case of emergency situations.

### Medical equipment



**Attention:** Never use the telephone in the vicinity of medical equipment. Effects on such equipment cannot be fully ruled out.

### Hearing aid compatible

The telephone is compatible with most popular hearing aids on the market. However, it cannot be guaranteed that all hearing aids will work perfectly.

DECT<sup>1</sup> telephones can cause an unpleasant humming sound in hearing aids.

<sup>1</sup> **DECT:** Digital Enhanced Cordless Telecommunication = Standard for cordless telephones.

# Preparing the Telephone

## Disposal

In order to dispose of your device, take it to a collection point provided by your local public waste authorities (e.g. recycling centre). The adjacent symbol indicates that the device must not be disposed of in normal domestic waste! According to laws on the disposal of electronic and electrical devices, owners are obliged to dispose of old **electronic and electrical devices** in a separate waste container.

**Batteries** must be disposed of at the point of sale or at the appropriate collection points provided by the public waste authorities.

**Packaging materials** must be disposed of according to local regulations.



## 2 Preparing the Telephone

### Safety information



**Attention:** It is essential to read the Safety Information in Chapter 1 before starting up.

### Checking the package contents

The package contains:

Content	Model DC62x <sup>1</sup>			
	621	622	623	624
Base station with power adapter plug	1	1	1	1
Charging station with power adapter plug	-	1	2	3
Handset	1	2	3	4
Telephone connection cable	1	1	1	1
Batteries	2	4	6	8
Operating instructions	1	1	1	1

### Connecting the base station



**Attention:** Position the base station at least 1 m away from other electronic devices, otherwise there is a risk of mutual disturbance.

Connect the base station as illustrated in the diagram. For reasons of safety, only use the power adapter plug and telephone connection cable supplied with the product.

<sup>1</sup> Visit [www.switel.com](http://www.switel.com) to find out whether the telephone/telephone set is already available.

# Preparing the Telephone

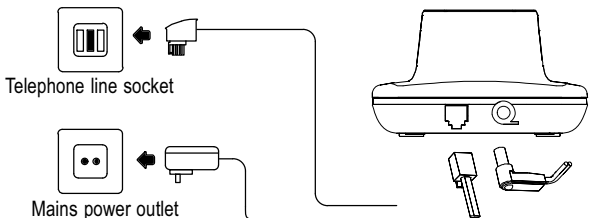

For the base station, use the power adapter plug labelled with no. VD060025D (or BD060025D) and output data 6 V, 250 mA.

## Connecting the charging station<sup>1</sup>

Connect the charging station as illustrated in the diagram. For safety reasons, only use the power adapter plug supplied.

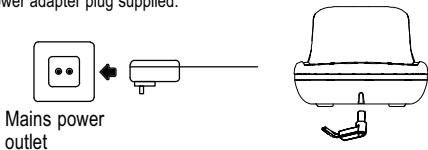

For the charging station, use the power adapter plug labelled with no. VD060015D (or BD060015D) and output data 6 V, 150 mA.

## Inserting the batteries

Insert the batteries in the open battery compartment. Only use batteries of the type AAA NiMH 1.2 V. Pay attention to correct polarity. Close the battery compartment cover.

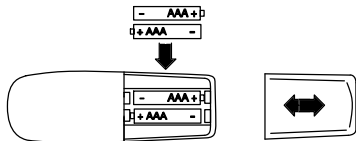

<sup>1</sup> Only applies to telephone sets with at least two handsets; "Checking the package contents" on Page 95.



# Preparing the Telephone

## Charging the batteries



Before the handset is used for the first time, insert it in the base station/charging station for **at least** 16 hours.

[When the handset is correctly inserted in the base station / charging station, an acoustic signal issued.] [When the handset is correctly inserted in the base station / charging station, the charge control lamp lights up.] The handset warms up during the charging process. This is normal and does not represent a risk. Do not charge the handset with charging units from other manufacturers. The current **battery charge status** is indicated in the display:



Full



Half empty



Low



Empty

## Setting the display language

Select the required language (also refer to "Menu Structure"):

[Left arrow] > MOBILTEIL > SPRACHE >...

[Right arrow] > HS SETTINGS > LANGUAGE >...

The German, French, Italian and English languages are available for selection.

## Setting the time and date on the handset

The time and date are set via the menu. Refer to Page 103 for the sequence of menu option selections.

## Automatic answering

If the Auto Talk function is activated, an incoming call is taken when the handset is removed from the base station. The automatic answering function is activated and deactivated using the menu. Refer to Page 104 for the sequence of menu option selections.

## Private branch exchanges

The information on Page 114 explains how to install your telephone in a private branch exchange.

## Low-radiation operation (ECO mode)

The level of radiation is considerably lower than that of standard DECT cordless telephones when in Standby mode when the handset is in the base station.

In talk mode, radiation is reduced (depending on the distance between the handset and base station).



# Operating Elements

## 3 Operating Elements

The buttons in this operating manual are subsequently depicted with a uniform contour. Therefore, slight deviations in the appearance of the symbols on the telephone buttons compared to those depicted here are possible.

### Handset

- 1 Loudspeaker
- 2 LCD display
- 3 Menu / OK button
- 4 Quick dial button M2
- 5 Headset connection
- 6 Delete /R button
- 7 Handsfree button
- 8 Digit keys
- 9 # button / Key lock
- 10 Microphone
- 11 Pause button
- 12 \* button / Internal call
- 13 Call / On-hook button
- 14 Scroll down / Call log
- 15 Quick dial button M1
- 16 Scroll up / Redial
- 17 LED

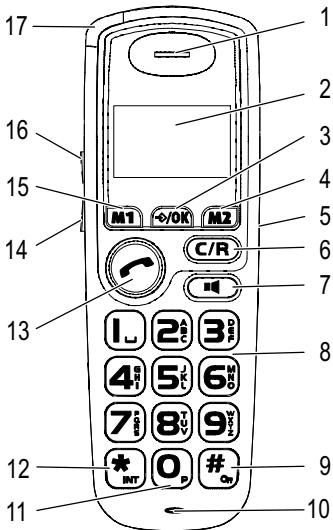

### Connecting the headset

The headset can be connected using a connection port located on the right-hand side of the handset. Use a 2.5 mm stereo phone jack to connect the headset. There is no guarantee the headset will function properly.

# Preliminary Information

## Base station



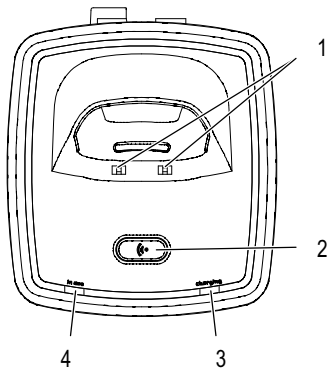





- 1 Charging contacts
- 2 Paging button
- 3 Charging LED
- 4 Operating status LED



## 4 Preliminary Information

This chapter provides basic information on using the operating instruction manual and the telephone.

### Description of operating sequences in the manual

Display	Description
	Displays the contour of buttons
	Press the button depicted briefly
2 sec. 	Press the button depicted for 2 seconds
	Enter digits or letters
	Handset rings
	Remove the handset from the base station
	Place the handset in the base station
	Depicts text in the display

# Preliminary Information



Depicts icons in the display

## Icons and texts in the handset display

Icon	Description
	On: Battery charge capacity indicator. Flashing: The batteries must be charged. Run-through segments: The batteries are being charged; Page 97.
1	Internally assigned call number of the handset;  Page 113.
12--59	Displays the time;  Page 103.
	A call is currently being made  Page 110.
	You have accessed the call log. New calls have been registered in the call log;  Page 108.
	The ringing tone has been switched off;  Page 103.
	The handsfree facility is activated;  Page 112.
	The key lock function is activated;  Page 112.
	The alarm function is enabled.
MESSAGE WAITING	Answering machine provided in the telephone network. <b>VMWI</b> <sup>1</sup> - Supplementary service offered by telephone network providers;  Page 115.
	The connection to the base station is good.

## Standby mode











All descriptions in this operating manual assume that the handset is in Standby mode which is the case when you are not talking on the phone and if a menu is not open. Press the button, several times if necessary, to enable the Standby mode.

<sup>1</sup> **VMWI: Visual Message Waiting Indication** = Visual indicator that new messages have been recorded.

# Preliminary Information

## Navigating in the menu

All the functions can be accessed via the various menus. Refer to Menu Structure Page 102 for information on how to access each respective function.









	Open the main menu
 or 	Select a submenu
	Open the submenu
 or 	Select a function
	Open the function
 or 	Select a setting
	Use the digit keys to enter numbers or letters
	Confirm the input
<b>C</b>	Move one level back
<b>C</b> several times, if necessary	Cancel the programming and saving processes and return to Standby mode



Every process is automatically cancelled if there is no input within 15 seconds.

## Creating phone book entries - example





The way in which to navigate through the menus and select settings is explained by means of the example **Creating phone book entries**. Proceed as in this example for all the settings.

	Open the main menu
PHONEBOOK 	Open the phone book
	Skip selection of entries
ADD NEW ENTRY 	Select the submenu and confirm it
 	Enter the name (max. 12 characters) and confirm it
 	Enter the phone number (max. 24 digits) and confirm it





# Menu Structure



## 5 Menu Structure



### Main menu

Press the  button to open the main menu. Then move to and select an entry using the  or  button and confirm your selection by pressing the  button. Further information on the menu and operation;  Chapter 4.

PHONEBOOK, select an entry /, skip selection 

ADD NEW ENTRY	NAME  <sup>1</sup>	NUMBER 
EDIT	NAME 	NUMBER 
DELETE RECORD	CONFIRM?	
DELETE ALL	CONFIRM?	

CALL LOG<sup>2</sup>, select an entry /, skip selection 

SAVE TO PHONEBOOK	NAME 	NUMBER 
DELETE RECORD	CONFIRM?	
DELETE ALL	CONFIRM?	



<sup>1</sup> Letters are also imprinted on the digit keys. Letters, digits and special characters are entered by pressing the relevant key the respective number of times.

<sup>2</sup> The call number display (**CLIP**<sup>3</sup>) is required to be able to display and store phone numbers in call log. The caller number display (CLIP) is a supplementary service offered by your telephone network provider. Contact your network provider for further information. For further information on the CLIP feature, refer to  Page 108.



<sup>3</sup> **CLIP**: Calling Line Identification Presentation = Displays the caller's phone number.

# Menu Structure









REDIAL, select entry /, skip selection 

SAVE TO PHONEBOOK	NAME 	NUMBER 
DELETE RECORD	CONFIRM?	
DELETE ALL	CONFIRM?	



## ALARMS

ALARM 1	CLEAR		
	SET	TIME 	CONFIRM?
ALARM 2	CLEAR		
	SET	TIME 	CONFIRM?

## HS SETTINGS

RINGER MELODY	EXTERNAL CALL MELODY	MELODY 1-10
	INTERNAL CALL MELODY	MELODY 1-10
HS RINGER VOLUME	VOLUME 1-5, OFF	
DATE/TIME SETTINGS	DATE/TIME	DATE  
		 CONFIRM?
		TIME  
		 CONFIRM?
	DATE/TIME FORMAT	DATE  

# Menu Structure

		<ul style="list-style-type: none"> <li>▶ DD/MM</li> <li>▶ MM/DD</li> <li>TIME  ▶</li> <li>▶ 12 HR</li> <li>▶ 24 HR</li> </ul>	
	BOOST MODE	ON	LOW
			MEDIUM
			HIGH
		AUTO	
	OFF		
KEY TONE	ON/OFF		
DISPLAY CONTRAST	LEVEL 1-8		
HANDSET NAME			
BACKLIGHT SETTING	5-30 SECONDS		
AUTO TALK	ON/OFF		
LANGUAGE <sup>1</sup>			
SET DEFAULT	CONFIRM?		

<sup>1</sup>For the languages available, refer to  Chapter 2.





# Menu Structure

---



## BS SETTINGS, INPUT PIN <sup>1</sup>

---

BASE RINGER MELODY	MELODY 1-5	
HS RINGER VOLUME	VOLUME 1-5, OFF	
CHANGE PIN <sup>1</sup>	NEW PIN 	CONFIRM PIN 
DIAL MODE	TONE	
	PULSE	
FLASH TIME	SHORT	
	MEDIUM	
	LONG	
VMWI <sup>2</sup>	VMWI OFF?	
SET DEFAULT	CONFIRM?	

## REGISTRATION

---

REGISTER	INPUT PIN 	
SELECT BASE	BASE 1-4	
REMOVE HANDSET	INPUT PIN 	HANDSET 1-4
REMOVE BASE	BASE 1-4	

<sup>1</sup> The default PIN code is "0000".

<sup>2</sup> **VMWI: Visual Message Waiting Indication** = Visual indication of new messages.

# Phone Book





## 6 Phone Book

You can use the phone book to store up to 100 phone numbers together with the associated names.

- Always enter the area access code with the phone numbers so that incoming local calls can also be assigned to a phone book entry.
- When the memory capacity is used up, the message **MEMORY FULL** appears when an attempt is made to store another number. To create space, an existing entry must first be deleted.
- The phone book entries are arranged alphabetically.

### Entering names







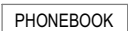

Letters are also imprinted on the digit keys. Letters, digits and special characters are entered by pressing the relevant key the respective number of times.

	Enter a space
	Delete characters
 or 	Moves the cursor

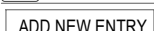

To enter the same letter twice, press the button to enter the letter. Wait until the cursor skips one position forwards. Enter the letter again.

### Creating phone book entries

	Open the main menu
 	Open the phone book
	Skip selection of entries
 	Select the submenu and confirm it
 	Enter the name (max. 12 characters) and confirm it
 	Enter the phone number (max. 24 digits) and confirm it

# Phone Book

## Editing phone book entries

	Open the main menu
PHONEBOOK	Open the phone book
or ,	Select and confirm an entry
or , EDIT	Select the submenu and confirm it
,	Change the name and confirm it
,	Change the phone number and confirm it

## Deleting phone book entries

### Deleting an entry

	Open the main menu
PHONEBOOK	Open the phone book
or ,	Select and confirm an entry
or , DELETE RECORD	Select the submenu and confirm it
CONFIRM? ,  or <b>C</b>	Confirm the deleting process or cancel it

### Deleting all entries

	Open the main menu
PHONEBOOK	Open the phone book
	Skip selection of entries
or , DELETE ALL	Select the submenu and confirm it
CONFIRM? ,  or <b>C</b>	Confirm the deleting process or cancel it

# Call Log

## Quick dial

You can assign one phone number each to the quick dial buttons **M1** and **M2**.

## Storing phone numbers as quick dial numbers

Enter the phone number or select one from the phonebook, redialling list or call log.

3 sec. **M1** or **M2**

Assign the selection to the corresponding one-touch dialling button



Entries assigned to the quick dial buttons cannot be deleted, they must be overwritten.

## 7 Call Log

A total of 20 calls are stored in the calls log.



The caller number display (**CLIP**<sup>1</sup>) is a supplementary service offered by your telephone network provider. The caller's number appears in the display if the service is offered by your telephone network provider. Contact your network provider for further information.

Messages in the display:

OUT OF AREA	The phone number is received only partially or with errors.
LONG DISTANCE	Information related to the phone number is not available. This could signify an international call.
PRIVATE	The caller has suppressed the transmission of their phone number.

## Displaying numbers in the call list

, or











Display the call log and select an entry

Press the button, several times if necessary, to switch between the "Name", "Number" and "Received time/date" displays.

<sup>1</sup> **CLIP**: Calling Line Identification Presentation = Displays the caller's phone number.

## Storing a phone number in the calls log in the phone book

A phone number in the call list can be stored in the phone book directly.







 ,  or 	Display the call log and select an entry
	Open the menu
 or  , <input type="text" value="SAVE TO PHONEBOOK"/>	Select and confirm the submenu
 , 	Enter the name (max. 12 characters) and confirm it
 , 	Change the phone number and confirm it







As soon as the phone number in the phone book has been saved together with a name, the name entered appears in the call list.

## Deleting phone numbers from the call list

Deleting individual phone numbers

 ,  or 	Display the call log and select an entry
	Open the menu
 or  , <input type="text" value="DELETE RECORD"/>	Select the submenu and confirm it
<input type="text" value="CONFIRM?"/>	Confirm the deleting process or cancel it

Deleting all phone numbers

	Open the call log
	Open the menu
 or  , <input type="text" value="DELETE ALL"/>	Select the submenu and confirm it
<input type="text" value="CONFIRM?"/>	Confirm the deleting process or cancel it

# Telephoning

## 8 Telephoning

### Taking a call

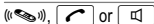

Take the call

### Ending a call



End the call

### Making a call



Enter the phone number (max. 24 digits)



Deletes the last digit if incorrect

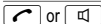

Dials the phone number



It is also possible to press the Call button  first to obtain the dialling tone for an outside line. The digits then entered are dialled immediately. It is not possible to correct wrong digits individually using this dialling procedure.

### Redialling

The telephone stores the last 10 phone numbers dialled in a redialling list.



Open the redialling list and select an entry



Dial the number

Editing phone numbers on the redialling list is identical to editing phone numbers on the call log;  Chapter 7.

### Calling back calls received

Your telephone stores 20 phone numbers in a call log.



Display the call log and select an entry



Dial the number

### Dialling numbers from the phone book

Phone numbers must have been stored in the phone book for this function;

 Chapter 6.



Open the main menu

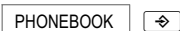

Open the phone book



Select an entry and dial the number

### Quick dial

Phone numbers must have been stored in the phone book for this function;

 Chapter 5.



3 sec. **M1** or **M2**

Execute the quick dial call



## Internal calls<sup>1</sup>

### Making internal calls

There must be two or more handsets (HS1, HS2, ...) registered on your base station in order to make internal calls free of charge.

HS1: 3 sec. <b>INT</b>	Activate the internal call function
e.g. <b>2</b> <sup>ABC</sup>	Dial the internal call number of the handset required
HS2: 	Other handset answers the call
HS1/HS2: 	End the internal call

### Forwarding external calls internally



HS1: 3 sec. <b>INT</b>	During an external call
e.g. <b>2</b> <sup>ABC</sup>	Dial the number of the internal handset
HS2: 	Other handset answers the call
HS1: 	Forward the call



If the handset called does not answer, the external call is returned to the calling handset after 30 seconds.

### Making conference calls

An external call can be transferred to another internal handset for a conference call.

HS1: 3 sec. <b>INT</b>	During an external call
e.g. <b>2</b> <sup>ABC</sup>	Dial the number of the internal handset
HS2: 	Other handset answers the call
HS1: 3 sec. <b>INT</b>	Start the conference
HS1 / HS2: 	End the conference

### Setting the receiver volume

The volume can be adjusted to one of 5 levels during a call.

 or 	Select a volume level
--	-----------------------

### Boost mode

There are further boosted volume levels in addition to the 5 basic levels;

 Chapter 5. Activate the boost level required to be able to use it.

BOOST MODE	Function
OFF	Only volume levels 1-5 are available

<sup>1</sup> Internal calls are only possible when at least two handsets are registered in the system;  "Checking the contents of the package" on Page 95.

# Telephoning



ON, LOW	Additional low boost can be selected
ON, MEDIUM	Additional low and medium boost can be selected
ON, HIGH	Additional low, medium and high boost can be selected
AUTO	Press  for 2 sec., the loudest setting is automatically selected

## Displaying the duration of a call

The duration of a call is displayed in hours, minutes and seconds during the call.



## Handsfree

This function is used to listen to the caller via the loudspeaker.

	Enables handsfree conversation
	Disables handsfree conversation

## Muting the microphone in the handset

The microphone in the handset can be activated and deactivated during a telephone conversation.

3 sec. 	Switch the microphone off (muting)
3 sec. 	Switch the microphone on

## Key lock

The key lock feature prevents functions assigned to buttons being activated accidentally.

3 sec. 	Locks the keys
--	----------------



Incoming calls can still be taken in the normal way even when the key lock function is activated.

3 sec. 	Unlocks the keys
--	------------------

## Searching for the handset (Paging)

If you have mislaid your handset, you can sound a paging tone to find it.

Base station  , 	Sound the paging tone
 or 	Stops sounding the paging tone



# Extending the Telephone System

## 9 Extending the Telephone System

The internationally approved **GAP**<sup>1</sup> standard regulates the compatibility of handsets and base stations from different manufacturers. As a result, it is possible to integrate **SWITEL** devices and devices from other manufacturers together in one telephone system. It is possible, however, that some functions are not available.

### Multiple handsets

Up to 5 handsets can be registered on the base station.

#### Registering handsets

Before starting to register a handset, switch the base station to Registration mode.

15 sec.  Enables the Registration mode

Now register the handset;  Chapter 5.

Use your current PIN code,  Chapter 5, to register it.

The handset is automatically assigned an internal call number following registration.

The internal call number appears in the display.



To register handsets from other manufacturers, please refer to the operating manual supplied with them.

#### Deregistering handsets



A handset can only be deregistered from a base station by using another handset registered to the same base station.

Handsets are deregistered via the menu. Chapter 5 indicates the position in the menu.

<sup>1</sup> **GAP: Generic Access Profile** = Standard for the interoperation of handsets and base stations from different manufacturers.

# Special Functions

---

## Multiple base stations

You can increase the range of your handset by registering it on several base stations. The handset can be registered on up to 4 different base stations simultaneously. Each base station requires its own telephone line socket. Connections can be used with the same call number or with different ones.



Calls in progress cannot be transferred from one base station to another.

## 10 Special Functions

### Dialling mode

The telephone can be operated in analogue exchanges (PULSE mode) as well as new, digital exchanges (TONE/DTMF mode). The dialling mode is controlled via the menu. Chapter 5 indicates the position in the menu.

## 11 PABX / Supplementary Services

### R-button on private branch exchanges

If the telephone is connected to a private branch exchange, functions such as transferring calls and automatic call back can be used via the **R button**. Refer to the operating manual provided with your private branch exchange as to which Flash time must be set in order to use these functions. The sales outlet where you purchased the exchange can provide information as to whether the telephone will work properly with the exchange. The Flash time is set using the menu. Chapter 5 indicates the position in the menu.

### Dialling pause

When using private branch exchanges, it is necessary to dial an access code to obtain the dialling tone for an outside line. When using some older private branch exchanges, it takes a little time before the dialling tone becomes audible. In the case of such private branch exchanges, a dialling pause can be inserted after the number for an outside line in order to continue dialling directly without having to wait for the dialling tone. The dialling pause is inserted by pressing and holding the **P** button for 3 seconds.

The actual phone number is dialled a certain time after the number for an outside line.



The dialling pause can also be entered with the phone numbers in the phone book.

# In Case of Problems

## R-button and supplementary services

Your telephone supports supplementary services provided by your telephone network provider, such as brokering, call waiting and conference facilities. These supplementary services can be used by implementing the **R button**. Please contact your telephone network provider regarding which Flash time must be set to use the supplementary services. Contact your telephone network provider with regard to enabling supplementary services. The Flash time is set using the menu. Chapter 5 indicates the position in the menu.

## Caller number display (CLIP<sup>1</sup>)



The caller number display (CLIP) is a supplementary service offered by your telephone network provider. Contact your network provider for further information.

If this function is available with your telephone line, the number of the caller appears in the display when the phone rings. If the caller has suppressed transmission of his phone number, the corresponding message appears in the display. The phone number is not displayed and, as a result, is not stored in the call list.

## Answering machine in the telephone network

An answering machine in the telephone network is a supplementary service offered by many telephone network providers. If your telephone network provider offers an answering machine in the telephone network for you, an icon on the display informs you of new messages received (**VMWI**<sup>2</sup>). This function can only be used when your telephone network provider actually offers the service. Contact your network provider for further information.

You can switch the new message indicator icon off. Refer to Chapter 5, VMWI OFF?.

## 12 In Case of Problems

### Service Hotline

Should problems arise with the telephone, please refer to the following information first. In the case of technical problems, you can contact our hotline service, Tel. 0900 00 1675 within Switzerland (Swisscom fees at time of going to print: CHF 2.60/min). In the case of claims under the terms of guarantee, please contact your sales outlet. The period of guarantee is 2 years.

<sup>1</sup> **CLIP**: Calling Line Identification Presentation = Displays the caller's phone number.

<sup>2</sup> **VMWI**: Visual Message Waiting Indication = Visual indicator that new messages have been recorded.

# In Case of Problems

## Problems and solutions

Problems	Solutions
No telephone calls possible	<ul style="list-style-type: none"><li>- The telephone is not connected properly or is defective. Only use the telephone connection cable supplied.</li><li>- Test whether the telephone connection is in order by using another telephone.</li><li>- The power adaptor plug is not plugged in or there is a complete power failure.</li><li>- The rechargeable batteries are empty or defective.</li><li>- The handset is too far from the base station.</li><li>- The wrong dialling mode is set; ☞ Page 105.</li></ul>
No connection to base station possible	<ul style="list-style-type: none"><li>- Check that the handset has been registered on the base station with the correct PIN code; ☞ Page 105.</li></ul>
Connection is disturbed or cut off	<ul style="list-style-type: none"><li>- The handset is too far from the base station.</li><li>- The base station is in an unsuitable location.</li></ul>
The system no longer responds	<ul style="list-style-type: none"><li>- Reset all the functions to their default settings; ☞ Page 104/105.</li><li>- Disconnect the power adaptor plug briefly from the power socket.</li></ul>
The batteries are empty within a short time	<ul style="list-style-type: none"><li>- The batteries are empty or defective.</li><li>- Place the handset in the base station properly. Clean the contact surfaces on the handset and base station with a soft, dry cloth.</li><li>- Place the handset in the base station for 16 hours.</li></ul>
The caller number display (CLIP <sup>1</sup> ) does not function	<ul style="list-style-type: none"><li>- The caller number display (CLIP) is a supplementary service offered by your telephone network provider. Contact your network provider for further information.</li><li>- The caller has suppressed the transmission of their phone number.</li></ul>

## 13 Technical Properties

### Technical data

Feature	Value
Standard	<b>DECT1-GAP<sup>2</sup></b>
Power supply (base station)	Input: 220/230 V, 50 Hz Output: 6 V, 250 mA
Power supply (charging station)	Input: 220/230 V, 50 Hz Output: 6 V, 150 mA
Range	Outdoors: Approx. 300 m Indoors: Approx. 50 m
Standby time	Up to 100 h
Max. talk time	Up to 10 h
Rechargeable batteries	2 x AAA NiMH 1.2 V
Dialling mode	Tone dialling mode Pulse dialling mode
Permissible ambient temperature	10°C to 30°C
Permissible relative humidity	20% to 75%
Flash function	100 ms, 300 ms, 600 ms

<sup>1</sup> **DECT**: Digital Enhanced Cordless Telecommunication = Standard for cordless telephones.

<sup>2</sup> **GAP**: Generic Access Profile = Standard for the interoperation of handsets and base stations from different manufacturers.

# Technical Properties

## Default settings

### Handset

The default settings can be restored via the menu. Refer to Page 104 for the sequence of menu option selections.

LANGUAGE = GERMAN	PHONEBOOK= Empty
CALL LOG = Empty	REDIAL = Empty
M1, M2 = Empty	ALARMS 1/2 = OFF
EXTERNAL CALL MELODY =1	INTERNAL CALL MELODY = 2
HS RINGER VOLUME = 3	AUTO TALK = ON
BOOST MODE = AUTO	
BACKLIGHT SETTING = 10 sec.	

### Base station

The default settings can be restored via the menu. Refer to Page 105 for the sequence of menu option selections.

BASE RINGER MELODY = 2	HS RINGER VOLUME = 1
DIAL MODE = TONE	PIN = 0000

## Declaration of Conformity

This device fulfils the requirements stipulated in the EU directive: 1999/5/EC directive on radio equipment and telecommunications terminal equipment and the mutual recognition of their conformity. Conformity with the above mentioned directive is confirmed by the CE symbol on the device.

To view the complete Declaration of Conformity, please refer to the free download available on our web site [www.switel.com](http://www.switel.com).



## 14 Maintenance / Guarantee

### Maintenance

- Clean the housing surfaces with a soft, fluff-free cloth.
- Do not use any cleaning agents or solvents.

### Guarantee

SWITEL equipment is produced and tested according to the latest production methods. The implementation of carefully chosen materials and highly developed technologies ensure trouble-free functioning and a long service life. The terms of guarantee do not apply where the cause of equipment malfunction is the fault of the telephone network operator or any interposed private branch extension system. The terms of guarantee do not apply to the batteries or power packs used in the products. The period of guarantee is 24 months from the date of purchase.

All deficiencies related to material or manufacturing errors within the period of guarantee will be redressed free of charge. Rights to claims under the terms of guarantee are annulled following tampering by the purchaser or third parties. Damage caused as the result of improper handling or operation, normal wear and tear, incorrect positioning or storage, improper connection or installation or Acts of God and other external influences are excluded from the terms of guarantee. In the case of complaints, we reserve the right to repair defect parts, replace them or replace the entire device. Replaced parts or devices become our property. Rights to compensation in the case of damage are excluded where there is no evidence of intent or gross negligence by the manufacturer.

If your device does show signs of a defect within the period of guarantee, please contact the sales outlet where you purchased the SWITEL device, producing the purchase receipt as evidence. All claims under the terms of guarantee in accordance with this agreement can only be asserted at the sales outlet. No claims under the terms of guarantee can be asserted after a period of two years from the date of purchase and hand-over of the product.

# Index

---

## 15 Index

### A

- Alarm, 103
- Answering machine in the telephone network, 115

### B

- Base station, 95, 114
- Battery charge status, 97
- Boost mode, 111

### C

- Call back, 110
- Call log, 102, 108
- Caller number display, 108, 115
- Charging, 97
- Charging station, 96
- CLIP, 115
- Conference calls, 111
- Connecting the headset, 98
- Creating, 101, 106

### D

- Date, 97
- Declaration of Conformity, 118
- Default settings, 104, 105, 118
- Deleting, 107, 109
- Deregistration, 105, 113
- Dialling, 110
- Dialling mode, 105, 114
- Dialling pause, 114
- Display, 100
- Display icons, 100
- Display language, 97
- Display messages, 108

### E

- ECO mode, 97
- Editing, 107
- Ending a call, 110
- Entering names, 106
- Entering text, 106
- Extending, 113

### F

- Forwarding calls, 111
- Functions, 114

### G

- Guarantee, 119

### H

- Handset, 113
- Handsfree, 112

### I

- Icons, 100
- Inserting the batteries, 96
- Internal calls, 111

### K

- Key lock, 112

### L

- Low-radiation, 97

### M

- Main menu, 102
- Maintenance, 119
- Making a call, 110
- Menu structure, 102
- Messages, 108
- Muting, 112
- Muting button, 112



## N

Notation, 99

## O

Operating elements, 98

Operation, 99

## P

Package contents, 95

Paging, 112

Phone book, 102, 106, 110

Phone book entries, 101, 106

Private branch exchanges, 114

Problems, 115

Problems and solutions, 116

Pulse dialling mode, 105, 114

## Q

Quick dial, 108, 110

## R

R-button, 114, 115

Receiver volume, 111

Redialling, 103, 110

Registering, 113

Registration, 105

Replace receiver, 110

Ringling melody, 103, 105

## S

Safety information, 94

Saving, 101, 106

Searching for the handset, 112

Service-Hotline, 115

Standby mode, 100

Starting up, 95

Storing, 109

Supplementary services, 114

## T

Taking a call, 97, 110

Talk time, 112

Technical data, 117

Telephoning, 110

Time, 97

Tone dialling mode, 105, 114

Troubleshooting, 115

## V

VMWI, 115

# Notes

---

## Notes

Notes

# **SWITEL**

## **Declaration of Conformity**



Diese Anlage entspricht der europäischen R&TTE Richtlinie.  
Für die komplette Konformitätserklärung nutzen Sie bitte den kostenlosen  
Download von unserer Website [www.switel.com](http://www.switel.com).

Cet équipement est conforme à la directive européenne R&TTE.  
Pour obtenir la déclaration de conformité intégrale, veuillez vous servir du  
téléchargement gratuit de notre site Internet [www.switel.com](http://www.switel.com).

Quest'apparecchiatura è conforme alla direttiva europea R&TTE.  
Per la dichiarazione di conformità completa si prega di voler usufruire del  
servizio gratuito di download dal nostro sito  
Internet [www.switel.com](http://www.switel.com).

This equipment complies with the European R&TTE directive.  
To view the complete Declaration of Conformity, please refer to the free down-  
load available at our web site: [www.switel.com](http://www.switel.com).

---

### **Service Hotline**

Bei technischen Problemen können Sie sich an unsere Service-Hotline unter  
Tel. 0900 00 1675 innerhalb der Schweiz (Kosten Swisscom bei Drucklegung:  
CHF 2.60/min) wenden.

S'il s'agit de problèmes techniques, vous pouvez vous adresser à notre hot-  
line de service en Suisse en appelant le numéro 0900 00 1675 (frais Swis-  
scom à la date d'impression de ce manuel : CHF 2.60/min).

In caso di problemi tecnici è possibile rivolgersi alla nostra hotline di assi-  
stenza tecnica chiamando al numero 0900 00 1675 valido per la Svizzera  
(spese da rete Swisscom alla data di stampa: CHF 2.60 / min).

In the event of technical problems, you can contact our hotline service, Tel.  
0900 00 1675 within Switzerland (cost via Swisscom at time of going to print:  
CHF 2.60/min).