

# **SWITEL**

**COMMUNICATION PRODUCTS**

Schnurlostelefon  
Téléphone sans fil  
Telefono senza fili  
Cordless telephone

## **DC46**



**Bedienungsanleitung**  
**Mode d'emploi**  
**Istruzioni per l'uso**  
**Operating Instructions**

D

F

I

GB

# ***SWITEL***

Bedienungsanleitung .....	3
Mode d'emploi .....	28
Istruzioni per l'uso .....	53
Operating Instructions .....	78
Declaration of Conformity .....	104

## - Inhaltsverzeichnis -

1	Sicherheitshinweise .....	4
2	Bedienelemente .....	6
3	Schnellstart .....	7
4	Display .....	9
5	Telefonieren .....	10
6	Navigation .....	14
7	Menüstruktur .....	15
8	Erklärungen .....	19
9	Fehlerbeseitigung .....	23
10	Wichtige Informationen .....	25
11	Index .....	26

## 1 Sicherheitshinweise

Lesen Sie diese Bedienungsanleitung sorgfältig durch.

### 1.1 Bestimmungsgemäße Verwendung

Dieses Telefon ist geeignet für das Telefonieren innerhalb eines Telefonnetzes. Jede andere Verwendung gilt als nicht bestimmungsgemäß. Eigenmächtige Veränderungen oder Umbauten sind nicht zulässig. Öffnen Sie das Gerät in keinem Fall selbst und führen Sie keine eigenen Reparaturversuche durch.

### 1.2 Aufstellungsort

Das Telefon ist für den Betrieb in Innenräumen mit einem Temperaturbereich von 10°C bis 30°C ausgelegt. Die Basisstation darf nicht in Feuchträumen wie Bad oder Waschküche aufgestellt werden. Vermeiden Sie Belastungen durch Rauch, Staub, Erschütterungen, Chemikalien, Feuchtigkeit, Hitze oder direkte Sonneneinstrahlung. Stellen Sie die Basisstation mit einem Abstand von 1 m zu anderen elektronischen Geräten auf, da es sonst zu gegenseitiger Störung kommen kann.

Verwenden Sie das Mobilteil nicht in explosionsgefährdeten Bereichen.

### 1.3 Netzteil



Verwenden Sie nur das mitgelieferte Steckernetzteil, da andere Netzteile das Telefon zerstören können. Sie dürfen den Zugang zum Steckernetzteil nicht durch Möbel oder andere Gegenstände versperren.

### 1.4 Telefonanschlusskabel

Achten Sie beim Austauschen des mitgelieferten Telefonanschlusskabels auf die identische Steckerbelegung.

### 1.5 Aufladbare Akkus

Werfen Sie Akkus nicht ins Feuer und tauchen Sie sie nicht ins Wasser.

### 1.6 Stromausfall

Bei Stromausfall kann mit dem Telefon nicht telefoniert werden. Halten Sie für Nötfälle ein schnurgebundenes Telefon bereit, welches ohne eine externe Stromversorgung arbeitet.

### 1.7 Nebenstellenanlagen

Sie können das Telefon an einer Nebenstellenanlage anschließen. Es kann **nicht** garantiert werden, dass das Telefon an jeder Nebenstellenanlage funktioniert.

### 1.8 Hinweis für medizinische Geräte

Benutzen Sie das Telefon nicht in der Nähe von medizinischen Geräten. Eine Beeinflussung von Herzschrittmachern kann nicht völlig ausgeschlossen werden. DECT\*-Telefone können in Hörgeräten einen unangenehmen Brummtönen verursachen.

### 1.9 Reinigung und Pflege

Reinigen Sie die Gehäuseoberflächen mit einem weichen und fusselfreien Tuch. Verwenden Sie keine Reinigungsmittel oder Lösungsmittel. Die Gummifüße der Basisstation sind nicht gegen alle Reinigungsmittel beständig.

### 1.10 Entsorgung

Sie sind gesetzlich zur sachgerechten Entsorgung von Gebrauchsgütern verpflichtet. Das nebenstehende Symbol auf Ihrem Telefon bedeutet, dass elektrische und elektronische Altgeräte und Akkus getrennt vom Hausmüll zu entsorgen sind.

**Elektrische oder elektronische Geräte** entsorgen Sie bei einer Sammelstelle eines geeigneten Entsorgungsträgers.

**Akkus** entsorgen Sie beim batterievertreibenden Handel sowie bei zuständigen Sammelstellen, die entsprechende Behälter bereitstellen.

**Verpackungsmaterialien** entsorgen Sie entsprechend den lokalen Vorschriften.



\* DECT: Digital European Cordless Telephone = Standard für kabellose Telefone.

## 2 Bedienelemente

### 2.1 Mobilteil

1. Dot-Matrix Display
2. Menütaste / Ok-Taste
3. Abwärts blättern / Anrufliste
4. Telefonbuch
5. Tastensperre
6. Sondertelefonbuch
7. R-Taste
8. Tonruf Ein / Aus
9. Gesprächstaste
10. Freisprechen Ein / Aus
11. Aufwärts blättern / Wahlwiederholung
12. Löschen / Stumm

### 2.2 Basisstation

13. Paging-Taste (Mobilteil suchen)

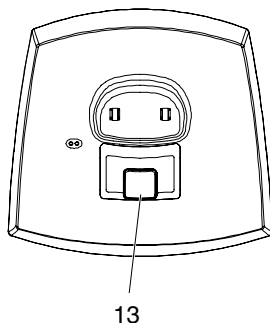
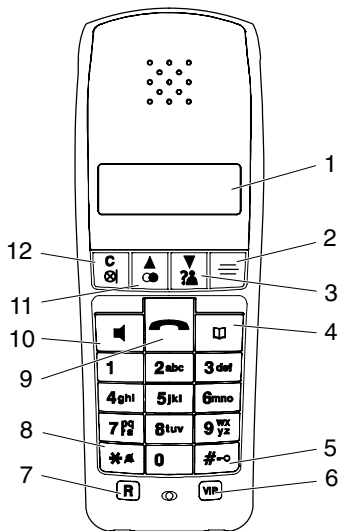

13

Die Tasten werden in dieser Bedienungsanleitung mit einer einheitlichen Kontur abgebildet. Abweichungen von Tastensymbolen Ihres Telefons gegenüber den hier abgebildeten Tastensymbolen sind möglich.

## 3 Schnellstart

### 3.1 Sicherheitshinweise



**Achtung:** Lesen Sie vor der Inbetriebnahme unbedingt die Sicherheitshinweise in Kapitel 1.

### 3.2 Verpackungsinhalt prüfen

Zum Lieferumfang gehören:

eine Basisstation mit Netzteil	ein Telefonanschlusskabel
ein Mobilteil mit Gürtelclip	zwei Akkus
eine Bedienungsanleitung	

### 3.3 Basisstation anschließen

Schließen Sie die Basisstation wie auf der Skizze abgebildet an. Verwenden Sie aus Sicherheitsgründen nur das mitgelieferte Netzteil sowie das beigefügte Telefonanschlusskabel.

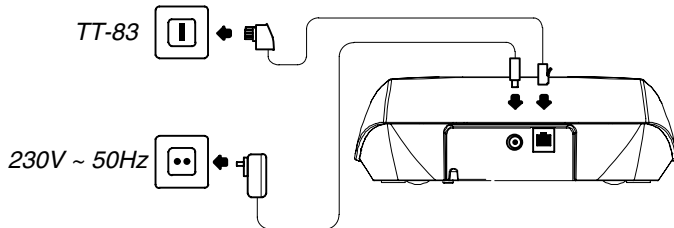

### 3.4 Akkus einsetzen

Legen Sie die Akkus in das geöffnete Batteriefach ein. Verwenden Sie nur Akkus des Typs AAA Ni-MH 1,2 V 600 mAh. Achten Sie auf die richtige Polung! Schließen Sie das Batteriefach.

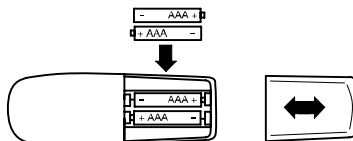

### 3.5 Akkus aufladen

Stellen Sie das Mobilteil bei der ersten Inbetriebnahme für mindestens 14 Stunden auf die Basisstation. Das Mobilteil erwärmt sich beim Laden. Dies ist normal und ungefährlich. Laden Sie das Mobilteil nicht mit fremden Aufladegeräten. Bei nicht richtig geladenen Akkus kann es zu Fehlfunktionen des Telefons kommen. Der aktuelle **Akkuladezustand** wird im Display angezeigt:

Voll	Halb	Schwach	Leer

### 3.6 Ton (DTMF)- oder IMPULS (IWV) - Wahlverfahren

Sie können Ihr Telefon sowohl an analogen Anschlüssen (Impuls-Wahl/IWV) als auch an digitalen Anschlüssen (Ton-Wahl/DTMF) anschließen. Das Gerät ist werkseitig auf das TON-Wahlverfahren (DTMF) eingestellt. Sollte Ihr Telefon nicht an Ihrem Anschluss funktionieren, erfahren Sie in Kapitel 7.1 wie Sie Ihr Telefon auf das IMPULS-Wahlverfahren (IWV) umstellen können.

### 3.7 Uhrzeit einstellen

In Kapitel 7.1 erfahren Sie, wie Sie bei der ersten Inbetriebnahme die Uhrzeit Ihres Mobilteils einstellen können.



## 4 Display



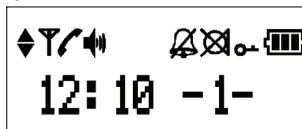

Das Display zeigt Ihnen alle wichtigen Funktionen mit verschiedenen Symbolen und Meldungen an.



Symbol	Beschreibung
	Sie blättern im Menü.
	Blinkend: Sie verlieren die Verbindung zur Basisstation. Dauerhaft: Die Verbindung zur Basisstation ist gut.
	Sie führen ein Gespräch.
	Freisprechen ist eingeschaltet.
	Der Tonruf ist ausgeschaltet.
	Das Mikrofon ist ausgeschaltet.
	Die Tastensperre ist eingeschaltet.
	Zeigt den aktuellen Akkuladestatus an.
12:10	Anzeige der Uhrzeit.
-1-	Interne Rufnummer des Mobilteils.

## 5 Telefonieren

### 5.1 Darstellungen und Schreibweisen

	Nummern oder Buchstaben eingeben
2 sec 	Abgebildete Taste 2 Sekunden drücken
	Tonsignalisierung am Mobilteil
 BEISPIEL oder 	Text oder Symbole im Display

### 5.2 Anrufe entgegennehmen

 ,  oder 	Gespräch annehmen
	Gespräch beenden

### 5.3 Zwei Anrufe entgegennehmen

Sie werden durch Signaltöne darauf hingewiesen (Anklopfen), dass während des Telefonierens ein weiterer Anruf eingeht. Sie können zwischen beiden Gesprächspartnern hin- und herwechseln.

 R,  2	Gesprächspartner wechseln
---	---------------------------



**Achtung:** Die Rufnummernanzeige, das Halten von Gesprächen und das Anklopfen sind Mehrwertdienste Ihres Netzbetreibers. Bitte fragen Sie Ihren Netzbetreiber nach weiteren Informationen.



Bitte fragen Sie Ihren Netzbetreiber, welche Flash-Zeit Sie zur Nutzung von Mehrwertdiensten einstellen müssen.



### 5.4 Anrufe führen

	Rufnummer eingeben (max. 20 Stellen)
 C	Bei Falscheingabe letzte Stelle löschen
	Rufnummer wählen

Sie können auch zuerst die Gesprächstaste  drücken und erhalten damit das Freizeichen. Die eingegebenen Ziffern Ihrer gewünschten Rufnummer werden sofort gewählt. Eine Korrektur einzelner Ziffern der Rufnummer ist nicht möglich. Bei dieser Form des Gesprächsaufbaus können Rufnummern mit bis zu 30 Stellen gewählt werden.

## 5.5 Zwei Anrufe führen

Während eines Gesprächs können Sie eine zweite Rufnummer wählen. Der erste Gesprächspartner wird gehalten, während Sie mit dem anderen Gesprächspartner sprechen. Sie können einen Telefonbucheintrag auswählen oder auch manuell eine Rufnummer über das Zahlenfeld eingeben. Sie können dann zwischen beiden Gesprächspartnern hin- und herwechseln.





	Während des Gesprächs drücken
	Rufnummer manuell eingeben

oder

	Während des Gesprächs drücken
 oder 	Telefonbuch öffnen
 oder  , 	Eintrag auswählen und bestätigen
 , 	Gesprächspartner wechseln





## 5.6 Wahlwiederholung

Ihr Telefon speichert die 10 zuletzt gewählten Rufnummern in einer Wahlwiederholungsliste ab.

	Wahlwiederholungsliste öffnen
 oder  , 	Eintrag auswählen und Verbindung herstellen

## 5.7 Verpasste Anrufe zurückrufen

Ihr Telefon speichert 10 verpasste Anrufe in einer Anrufliste ab.

	Anrufliste öffnen
 oder  , 	Eintrag auswählen und Verbindung herstellen

## 5.8 Kettenwahl

Die Funktion Kettenwahl findet Anwendung bei komplexeren Telefondiensten wie z. B. Telefonbanking, Call by Call oder Calling-Card-Verfahren. Die Funktion nutzen Sie, um mehrere gespeicherte Nummern während einer bestehenden Verbindung aus dem Telefonbuch zu übertragen. Sie können Übertragungen von Nummern aus dem Telefonbuch mit manuellen Nummereingaben kombinieren. Sie können während einer Verbindung beliebig viele Einträge aus dem Telefonbuch verketten und übertragen.

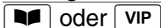

oder **VIP**

Während einer bestehenden Verbindung Telefonbuch öffnen



oder ▼, ☰

Telefonbucheintrag auswählen und Nummer übertragen

## 5.9 Temporäre Tonwahl

Können Sie Ihr Telefon nur mit dem IMPULS-Wahlverfahren betreiben, brauchen Sie nicht auf die Vorteile des TON-Wahlverfahrens (z. B.: Abfrage eines Anrufbeantworters) zu verzichten. Während eines Gesprächs können Sie vorübergehend zum TON-Wahlverfahren wechseln.



1 sec \* / # □

Während des Gesprächs drücken

Nach Gesprächsende wird wieder automatisch auf das IMPULS-Wahlverfahren zurückgeschaltet.

## 5.10 Einstellen der Hörerlautstärke

Sie können während eines Gesprächs die Lautstärke in fünf Stufen anpassen.



▲ oder ▼ ■ bis



■■■■■, ☰

Während des Gesprächs drücken

## 5.11 Freisprechen

Nutzen Sie diese Funktion, um freihändig zu telefonieren.



☎ □

Drücken zum Einschalten



☎

Drücken zum Ausschalten



### 5.12 Mikrofon im Mobilteil stummschalten

Sie können während eines Telefongesprächs das Mikrofon des Mobilteils aus- und einschalten.

C		Drücken zum Einschalten
C		Drücken zum Ausschalten



### 5.13 Tastensperre

Bei eingeschalteter Tastensperre können eingehende Anrufe wie gewohnt entgegengenommen werden.

2 sec	 	Drücken zum Einschalten
2 sec		Drücken zum Ausschalten

### 5.14 Tonrufmelodie des Mobilteils



Sie können die Tonrufmelodie am Mobilteil ausschalten.

2 sec	 	Drücken zum Ausschalten
2 sec		Drücken zum Einschalten

### 5.15 Anzeige der Gesprächsdauer

Während eines Gesprächs wird die Gesprächsdauer in Stunden, Minuten und Sekunden angezeigt.











### 5.16 Paging von der Basisstation zum Mobilteil

Drücken Sie an der Basisstation die Paging-Taste , um für 60 Sekunden die Rufsignale des Mobilteils zu hören. Drücken Sie erneut die Paging-Taste  oder die Gesprächstaste  am Mobilteil, um die Funktion vor Ablauf der 60 Sekunden zu beenden.

## 6 Navigation

### 6.1 Navigation im Menü

Alle Funktionen sind über unterschiedliche Menüs zu erreichen. Den Weg zur gewünschten Funktion entnehmen Sie der Menüstruktur.

1. Öffnen Sie das gewünschte Menü oder Telefonbuch mit der jeweiligen Taste.
2. Mit Taste  oder  gewünschtes Untermenü auswählen.
3. Mit Taste  Untermenü öffnen.
4. Mit Taste  oder  gewünschte Funktion auswählen.
5. Mit Taste  Funktion öffnen.
6. Mit Taste  oder  gewünschte Einstellung auswählen.
7. Über Tastenfeld Nummern oder Buchstaben eingeben.
8. Mit Taste  Eingaben bestätigen.
9. Mit Taste  gelangen Sie jeweils eine Ebene zurück.
10. Mit 2 sec Taste  Programmier- und Speichervorgänge abbrechen und in den Standby-Modus zurückkehren.



Jeder Vorgang wird automatisch abgebrochen, wenn innerhalb von 30 Sekunden keine Eingabe erfolgt.

### 6.2 Beispiel

Wie Sie in den Menüs navigieren und Eingaben vornehmen ist hier anhand des Beispiels "Telefonbucheinträge erstellen" erklärt. Verfahren Sie bei allen Einstellungen wie bei diesem Beispiel.



Telefonbuch öffnen



oder



Neu



Funktion auswählen und bestätigen





Rufnummer eingeben (max. 20 Stellen) und bestätigen

































Namen eingeben (max. 12 Zeichen) und bestätigen

## 7 Menüstruktur

### 7.1 Das Hauptmenü

In das Hauptmenü gelangen Sie durch Drücken der Taste . Wählen Sie mit den Tasten  oder  das gewünschte Untermenü.

Wahlwiederh.		Eintrag 1		Auswählen		
		Eintrag 2		Nr. speichern		 Name 
		Eintrag ...		Löschen		Löschen? 
				Liste lösch.		Liste lösch? 

Anrufliste		Eintrag 1		Auswählen		
		Eintrag 2		Nr. speichern		 Name 
		Eintrag ...		Löschen		Löschen? 
				Liste lösch.		Liste lösch? 

\* Intern anr.   Rufnummer (intern)

\* Diese Funktion ist nur in der Bundle-Version verfügbar.



MT einstell.		Rufmelodie		Melodie 1			
				Melodie 2			
				Melodie ...			
		Ruflautst.		Lautstärke 1			
				Lautstärke 2			
				Lautstärke ...			
		Töne		Akkuswarnton		Ein	
						Aus	
				Reichweite		Ein	
						Aus	
				Tastentöne		Ein	
						Aus	
		Sprache		Deutsch			
				Französisch			
				Italienisch			
		Rücksetzen		Rücksetzen?			



Basis einstell.		PIN ändern		⌘ PIN eingeb.		⌘ Neue PIN	
						⌘ PIN wiederh.	
		Wahlverf.		DTMF			
				Impuls			
		Flash-Zeit		80, 100, 120,			
				180, 250, 300,			
				600 oder 800 ms			
		Amtskennzahl		⌘ Amtskennzahl			
		Rücksetzen		⌘ PIN eingeb.		Rücksetzen?	
Datum / Zeit		⌘ Jahr		⌘ Datum		⌘ Zeit	



## 7.2 Das Telefonbuch

	Eintrag 1		Neu			Rufnummer			Name	
	Eintrag 2									
	Eintrag ...		Auswählen							
			Ändern			Rufnummer			Name	
			Löschen		Löschen?					

## 7.3 Das Sondertelefonbuch<sup>1</sup>

	Leer		Auswählen							
	Leer									
	...		Ändern			Rufnummer			Name	
			Löschen		Löschen?					

<sup>1</sup> Im Sondertelefonbuch werden neue Einträge über das Untermenü "Ändern" erstellt.

## **8 Erklärungen**

### **8.1 R-Taste an Nebenstellenanlagen**

Ist Ihr Telefon über eine Nebenstellenanlage angeschlossen, können Sie über die R-Taste (7.) alle Möglichkeiten, wie z. B. Anrufe weiterleiten, automatischen Rückruf, nutzen. An einer Nebenstellenanlage wird eine Flash-Zeit von 100 ms benötigt. Ob Ihr Telefon an Ihrer Nebenstellenanlage einwandfrei funktioniert, erfahren Sie bei dem Händler, bei dem die Anlage gekauft wurde.

### **8.2 R-Taste und Mehrwertdienste**

Ihr Telefon unterstützt die wichtigsten Mehrwertdienste ihres Netzbetreibers (z. B. Makeln, Anklopfen, Dreier-Konferenz). Die R-Taste (7.) können Sie bei der Verwendung der Mehrwertdienste nutzen. Bitte fragen Sie Ihren Netzbetreiber, welche Flash-Zeit Sie zur Nutzung von Mehrwertdiensten einstellen müssen.

### **8.3 Rufnummernanzeige (CLIP)**

Die Rufnummernanzeige ist ein optionaler Service Ihres Netzbetreibers. Fragen Sie Ihren Netzbetreiber nach weiteren Informationen.

Wenn diese Funktion an Ihrer Telefonleitung zur Verfügung steht, zeigt Ihnen das Display bereits die Rufnummer des Anrufers, wenn das Telefon klingelt. Hat der Anrufer das Übertragen seiner Rufnummer unterdrückt, zeigt das Display eine entsprechende Meldung.

### **8.4 Intern anrufen**

Diese Funktion ist nur in der Bundle-Version verfügbar.

### **8.5 Einstellungen Mobilteil**

#### **8.5.1 Tonrufmelodie**

An Ihrem Mobilteil können 6 verschiedene Tonrufmelodien eingestellt werden.

#### **8.5.2 Tonruflautstärke**

Sie können die Tonruflautstärke in 5 Stufen einstellen.

#### **8.5.3 Akkuwarnton**

Wenn die Akkukapazität sehr gering ist, werden Warntöne vom Mobilteil wiedergegeben.

### **8.5.4 Reichweitenwarnton**

Haben Sie sich zu weit von der Basisstation entfernt, werden Warntöne vom Mobilteil wiedergegeben.

### **8.5.5 Tastenton**

Bei jedem Tastendruck wird ein Ton vom Mobilteil wiedergegeben.

### **8.5.6 Rücksetzen Mobilteil**

Mit dieser Funktion wird das Mobilteil wieder auf die Werkseinstellungen zurückgesetzt.

## **8.6 Einstellungen Basisstation**

### **8.6.1 PIN-Code**

Der PIN-Code kann aus bis zu vier Zahlen bestehen. Die Werkseinstellung des PIN-Codes ist "0000". Wenn Sie den PIN-Code ändern, bewahren Sie den neuen PIN-Code gut auf. Sollten Sie den PIN-Code vergessen oder verloren haben, wenden Sie sich bitte an Ihren Fachhändler.

### **8.6.2 Ton (DTMF)- oder Impuls (IWV) - Wahlverfahren**

Sie können Ihr Telefon sowohl an den analogen Vermittlungsstellen (IWV/IMPULS) als auch an den neuen digitalen Vermittlungsstellen (DTMF/TON) betreiben.

### **8.6.3 Flash-Zeit**

Sie können die R-Taste (7.) mit 8 unterschiedlichen Flash-Zeiten belegen, um Funktionen in Nebenstellenanlagen oder Mehrwertdienste Ihres Netzbetreibers zu nutzen.

### **8.6.4 Amtskennzahl**

Bei Nebenstellenanlagen ist es erforderlich, eine bestimmte Nummer zu wählen, um ein Freizeichen für eine Amtsleitung zu bekommen. Diese Amtskennzahl können Sie speichern. Wenn Ihr Telefon diese Amtskennzahl vor einer eingegebenen Rufnummer erkennt, wird automatisch nach der Amtskennzahl eine Wahlpause eingefügt.

### **8.6.5 Rücksetzen Basisstation**

Mit dieser Funktion wird die Basisstation wieder auf die Werkseinstellungen zurückgesetzt. Sie müssen den PIN-Code eingeben, um die Funktion auszuführen.

## **8.7 Telefonbuch**

Im Telefonbuch können Sie 20 Rufnummern inklusive Namen speichern. Im Sondertelefonbuch können Sie 10 Einträge vornehmen. Auf Einträge im Telefonbuch können Sie nur mit dem Mobilteil zugreifen, mit dem die Einträge erstellt wurden. Die Einträge im Sondertelefonbuch sind für alle angemeldeten Mobilteile abrufbar.

### **8.7.1 Namen eingeben**

Zur Eingabe des Namens sind die Zahlentasten mit Buchstaben beschriftet. Durch mehrmaliges Drücken der entsprechenden Taste können Buchstaben, Zahlen und Sonderzeichen eingegeben werden.

Um ein Leerzeichen einzugeben, drücken Sie einmal die Taste 1.

Um Sonderzeichen einzugeben, drücken Sie mehrmals die Taste 0, Taste 1 oder Taste #, bis Sie das gewünschte Sonderzeichen erreicht haben.

Um zwischen der Eingabe von Großbuchstaben und Kleinbuchstaben zu wechseln, drücken Sie einmal die Sterntaste.

Um den gleichen Buchstaben zweimal einzugeben, drücken Sie den entsprechenden Buchstaben. Warten Sie bis der Cursor weiterspringt. Geben Sie nun den Buchstaben erneut ein.

Bei Falscheingaben können Sie die letzte Stelle mit der Taste (12.) löschen.

### **8.7.2 Telefonbucheinträge erstellen**

Geben Sie bei allen Rufnummern immer die Vorwahl mit ein, damit das Telefon auch eingehende Ortsgespräche einem Telefonbucheintrag zuordnen kann. Ist die Speicherkapazität des Telefonbuchs erreicht, zeigt das Display beim nächsten Speichern eine entsprechende Meldung. Um wieder Platz zu schaffen, müssen Sie zuerst einen anderen Telefonbucheintrag löschen.

### **8.7.3 Rufnummern aus dem Telefonbuch wählen**

Wenn Sie sich im Telefonbuch befinden, können Sie Einträge direkt alphabetisch auswählen. Drücken Sie dazu die Taste mit dem entsprechenden Anfangsbuchstaben des Telefonbucheintrags.

Wählen Sie einen Telefonbucheintrag aus dem privaten oder dem gemeinsamen Telefonbuch aus und stellen Sie mit der Gesprächstaste (9.) die Verbindung her.

## - Erklärungen -

### 8.8 Werkseinstellungen

<b>Mobilteil</b>		<b>Basisstation</b>	
Tonruf lautstärke:	5	PIN-Code:	0000
Tonrufmelodie:	1	Anrufliste:	leer
Akkubarnton:	Ein	Wahlverfahren:	DTMF
Reichweitenwarnton:	Ein	Flash-Zeit:	100 ms
Tastenton:	Ein	Amtskennzahl:	leer
Hörerlautstärke:	3		
Lautsprecherlautstärke:	3		
Tastensperre:	Aus		
Wahlwiederholungsliste:	leer		
Telefonbuch privat:	leer		

### 9 Fehlerbeseitigung

Haben Sie Probleme mit Ihrem Telefon, kontrollieren Sie zuerst die folgenden Hinweise. Bei Garantieansprüchen wenden Sie sich an Ihren Fachhändler.

<b>Fehler</b>	<b>Lösungen</b>
Kein Telefongespräch möglich	<ul style="list-style-type: none"><li>- Die Telefonleitung ist nicht korrekt angeschlossen oder gestört. Verwenden Sie nur das mitgelieferte Telefonanschlusskabel.</li><li>- Testen Sie mit einem anderen Telefon, ob Ihr Telefonanschluss in Ordnung ist.</li><li>- Das Netzteil ist nicht eingesteckt oder es liegt ein totaler Stromausfall vor.</li><li>- Die aufladbaren Akkus sind leer oder defekt.</li><li>- Sie haben sich zu weit von der Basisstation entfernt.</li></ul>
Verbindung abgehackt, fällt aus	<ul style="list-style-type: none"><li>- Sie haben sich zu weit von der Basisstation entfernt.</li><li>- Falscher Aufstellungsort der Basisstation.</li></ul>
Keine Wahl möglich	<ul style="list-style-type: none"><li>- Wahlverfahren falsch eingestellt.</li></ul>
Das System reagiert nicht mehr oder befindet sich in einem undefinierten Zustand	<ul style="list-style-type: none"><li>- Setzen Sie alle Funktionen in den Werkszustand zurück.</li><li>- Ziehen Sie kurzzeitig das Netzteil aus der Steckdose.</li></ul>
Das Mobilteil schaltet sich von selbst ab	<ul style="list-style-type: none"><li>- Stellen Sie das Mobilteil für 14 Stunden auf die Basisstation. Erneuern Sie die aufladbaren Akkus.</li></ul>

## - Fehlerbeseitigung -

Fehler	Lösungen
Nach einer Aufladezeit von 14 Stunden zeigt das Display unverändert das Symbol 	<ul style="list-style-type: none"><li>- Die aufladbaren Akkus sind leer oder defekt.</li><li>- Stellen Sie das Mobilteil richtig auf die Basisstation. Reinigen Sie die Kontaktflächen am Mobilteil und an der Basisstation mit einem weichen, trockenen Tuch.</li></ul>
Display-Anzeige dunkel	<ul style="list-style-type: none"><li>- Verursacht durch direkte Sonnenbestrahlung. Lassen Sie das Mobilteil abkühlen.</li></ul>
Die Rufnummernanzeige (CLIP) funktioniert nicht	<ul style="list-style-type: none"><li>- Die Rufnummernanzeige ist ein optionaler Service Ihres Netzbetreibers. Bitte fragen Sie Ihren Netzbetreiber nach weiteren Informationen.</li><li>- Der Anrufer hat das Übertragen seiner Rufnummer unterdrückt.</li></ul>



## - Wichtige Informationen -

### 10 Wichtige Informationen

#### 10.1 Technische Daten

Merkmal	Wert
Standard	DECT
Stromversorgung	Eingang: 220/230 V, 50 Hz Ausgang: 6 V, 300 mA
Reichweite (Außen/Innen)	300 m, 50 m
Standby	bis zu 100 h
Max. Gesprächsdauer	bis zu 10 h
Aufladbare Standard-Akkus	2 x 1.2 V/600 mAh, Größe: AAA
Wahlverfahren	Ton-Wahlverfahren (DTMF) Impuls-Wahlverfahren (IWW)
Zulässige Umgebungstemperatur	10°C bis 30°C
Zulässige relative Luftfeuchtigkeit	20% bis 75%
Flash-Funktion	80, 100, 120, 180, 250, 300, 600 oder 800 ms

D

DECT: **D**igital **E**uropean **C**ordless **T**elephone = Standard für kabellose Telefone.

## **11 Index**

### **A**

Akkuladezustand, 8  
Akkus aufladen, 8  
Akkus einsetzen, 7  
Akkuwarnton, 16, 19  
Amtskennzahl, 17, 20  
Anrufe entgegennehmen, 10  
Anrufliste, 15

### **B**

Basisstation anschließen, 7  
Bedienelemente, 6

### **D**

Darstellungen, 10  
Datum, 17  
Display, 9

### **E**

Einstellungen Basisstation, 17, 20  
Einstellungen Mobilteil, 16, 19

### **F**

Fehlerbeseitigung, 23  
Flash-Zeit, 17, 20  
Freisprechen, 12

### **G**

Gesprächsdauer, 13

### **H**

Hörerlautstärke, 12

### **I**

Impuls - Wahlverfahren, 17, 20  
Intern anrufen, 15, 19

### **K**

Kettenwahl, 12

### **M**

Mikrofon stummschalten, 13

### **N**

Namen eingeben, 21  
Navigation, 14

### **P**

Paging, 13  
PIN-Code, 17, 20

### **R**

R-Taste, 20  
R-Taste an Nebenstellenanlagen, 19  
R-Taste und Mehrwertdienste, 19  
Reichweitenwarnton, 16, 20  
Rücksetzen Basisstation, 17, 20  
Rücksetzen Mobilteil, 16, 20  
Rufnummer aus der Anrufliste im Telefonbuch speichern, 15  
Rufnummer aus der Anrufliste wählen, 15  
Rufnummern aus dem Telefonbuch wählen, 18, 21  
Rufnummernanzeige, 19

### **S**

Schreibweisen, 10  
Sicherheitshinweise, 4  
Sondertelefonbuch, 18, 21  
Sprache einstellen, 16

**T**

Tastensperre, 13  
Tastenton, 16, 20  
Technische Daten, 25  
Telefonbuch, 18, 21  
Telefonbucheinträge  
  erstellen, 14, 18, 21  
Telefonieren, 10  
Temporäre Tonwahl, 12  
Ton - Wahlverfahren, 17, 20  
Tonruf lautstärke, 16, 19  
Tonrufmelodie, 13, 16, 19

**U**

Uhrzeit, 17

**V**

Verpackungsinhalt, 7

**W**

Wahlpause, 20  
Wahlverfahren, 20  
Wahlwiederholung, 11, 15  
Werkseinstellungen, 22

**- Table des matières -**

1	Consignes de sécurité .....	29
2	Éléments de manipulation .....	31
3	Démarrage rapide .....	32
4	L'écran .....	34
5	Téléphoner .....	35
6	Navigation .....	39
7	Structure du menu .....	40
8	Explications .....	44
9	Élimination des perturbations .....	48
10	Informations importantes .....	50
11	Index .....	51

## **1 Consignes de sécurité**

Lisez très attentivement ce mode d'emploi.

### **1.1 Utilisation conforme aux prescriptions**

Ce téléphone convient pour téléphoner à l'intérieur d'un réseau téléphonique. Toute autre utilisation est considérée comme non conforme à son usage. Des modifications ou changements effectués d'un propre gré ne sont pas autorisés. N'ouvrez en aucun cas l'appareil et n'effectuez aucun essai de réparation vous-même.

### **1.2 Lieu d'installation**

Le téléphone est conçu pour un fonctionnement à l'intérieur de pièces dont la température est comprise entre 10 °C et 30 °C. La base ne doit pas être placée dans des pièces humides comme la salle de bains ou la buanderie. Evitez toute nuisance par la fumée, la poussière, les tremblements, les produits chimiques, l'humidité, la grande chaleur ou l'ensoleillement direct. Posez la base à une distance d'1 m par rapport à d'autres appareils électroniques pour éviter d'éventuelles interactions. N'utilisez pas le combiné dans des zones exposées aux explosions.

### **1.3 Bloc secteur**



N'utilisez que le bloc d'alimentation enfichable fourni avec l'appareil, d'autres pouvant détruire votre téléphone. Vous ne devez pas bloquer son accès par des meubles ou autres objets.

### **1.4 Câble de raccordement téléphonique**

Lorsque vous remplacez le câble de raccordement fourni avec l'appareil, veillez à une affectation identique des plots de connexion.

### **1.5 Piles rechargeables**

Ne jetez pas les piles dans le feu ou ne les plongez pas dans l'eau.

### **1.6 Panne de courant**

En cas de panne de courant, vous ne pouvez pas téléphoner avec cet appareil. Pour les cas d'urgence, ayez à votre disposition un téléphone à fil fonctionnant sans alimentation externe en courant.

### **1.7 Installations à postes supplémentaires**

Vous pouvez raccorder votre téléphone à une installation à postes supplémentaires. **Il ne peut pas** être garanti que le téléphone fonctionne avec chaque installation de ce genre.

## - Consignes de sécurité -

### 1.8 Remarque relative aux appareils médicaux

N'utilisez pas le téléphone à proximité d'appareils médicaux. Une influence sur les stimulateurs cardiaques ne peut être totalement exclue. Les téléphones DECT\* peuvent causer un bourdonnement désagréable dans les prothèses auditives.

### 1.9 Nettoyage et entretien

Nettoyez les surfaces du boîtier avec un chiffon doux et non pelucheux. N'utilisez pas de produits nettoyants ou de solvants. Les pieds en caoutchouc de la base ne résistent pas à tous les produits d'entretien.

### 1.10 Elimination

Le transfert du droit européen dans des lois et règlements nationaux vous obligent à éliminer vos biens de consommation de façon conforme. L'icône ci-contre sur votre téléphone signifie que les anciens appareils électriques et électroniques doivent être éliminés séparément des ordures ménagères.



**Éliminez les appareils électriques ou électroniques** dans le centre de collecte d'un organisme approprié d'évacuation des déchets.



**Éliminez les piles** auprès d'un revendeur spécialisé ainsi que dans des centres de collectes qui tiennent à disposition les collecteurs appropriés correspondants.

Éliminez les **fournitures d'emballage** conformément au règlement local.

\* DECT: **D**igital **E**uropean **C**ordless **T**elephone = Standard pour téléphones sans fil.

## 2 Éléments de manipulation

### 2.1 Combiné

1. Écran dot-Matrix
2. Touche de menu / Touche OK
3. Faire défiler vers le bas / Liste d'appels
4. Répertoire
5. Verrouillage du clavier
6. Répertoire spécial
7. Touche R
8. Sonnerie d'appel Marche/ Arrêt
9. Touche de communication
10. Mode mains-libres Marche/ Arrêt
11. Faire défiler vers le haut / BIS
12. Supprimer / Débrancher le microphone

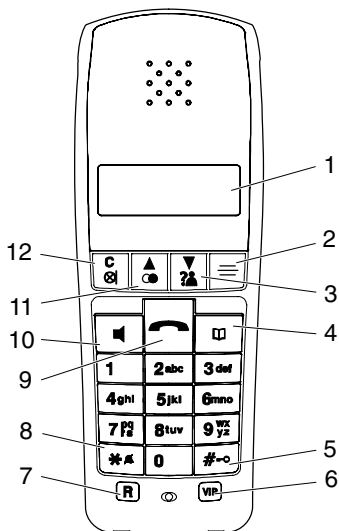

### 2.2 Base

13. Touche de paging (recherche du combiné)

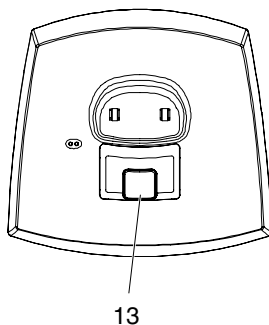

Les touches sont représentées dans ce mode d'emploi par un contour uniforme. Des icônes différents sur votre téléphone par rapport à ceux représentés ici sont possibles.

## - Démarrage rapide -

### 3 Démarrage rapide

#### 3.1 Remarques concernant la sécurité



**Attention :** Avant de mettre votre appareil en service, lisez impérativement les consignes de sécurité mentionnées au chapitre 1.

#### 3.2 Vérifier le contenu de l'emballage

Les éléments suivants font partie de la livraison :

une base avec bloc d'alimentation	un câble de raccordement téléphonique
un combiné muni d'un clip de ceinture	deux piles rechargeables
un mode d'emploi	

#### 3.3 Raccorder la base

Raccordez la base tel que décrit sur le croquis. Pour des raisons de sécurité, n'utilisez que le bloc d'alimentation et le câble de raccordement contenus dans la livraison.

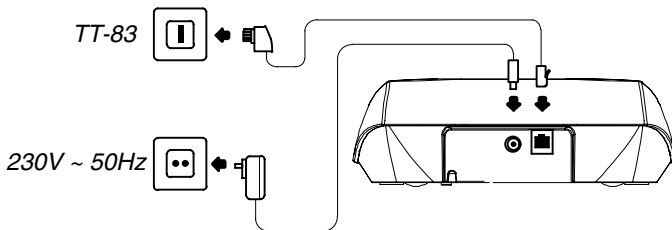



## - Démarrage rapide -



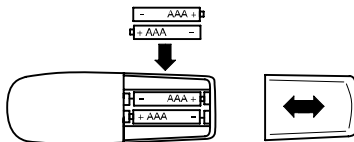

### 3.4 Placer les piles

Placez les piles dans le compartiment prévu à cet effet. N'utilisez que des piles de type AAA Ni-MH 1,2 V 600 mAh. Observez une polarisation correcte ! Fermez le compartiment à piles.



### 3.5 Chargement des piles

Lors d'une première mise en service, posez le combiné pendant au moins 14 heures sur sa base. Le combiné chauffe lors du chargement. C'est normal et ce n'est pas dangereux. Ne chargez pas le combiné avec des chargeurs d'un autre fabricant. Si les piles ne sont pas chargées correctement, le téléphone peut présenter des dysfonctionnements. Le **niveau actuel de chargement** des piles est affiché sur l'écran :

			
Plein	Moyen	Faible	Vide

### 3.6 Système de numérotation par tonalité (DTMF) ou par impulsions (I WV)

Vous pouvez raccorder votre téléphone aussi bien à des raccordements analogiques (numérotation par impulsions/I WV) que numériques (numérotation par tonalité/DTMF). Votre téléphone a été paramétré en usine sur la numérotation par tonalité (DTMF). S'il ne fonctionne pas sur votre raccordement, lisez au chapitre 8.1 comment vous pouvez le faire passer sur la numérotation par IMPULSIONS (I WV).







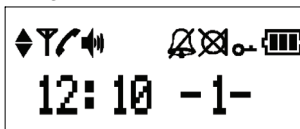

### 3.7 Réglage de l'heure

Le chapitre 8.1 vous dira comment vous pouvez régler l'heure de votre combiné à sa première mise en service.

## 4 L'écran

L'écran vous affiche toutes les fonctionnalités importantes avec leurs différents icônes et messages.



icône	Description
	Vous faites défiler le menu.
	Clignotant: vous perdez la liaison avec la base. En continu: la liaison avec la base est bonne.
	Vous téléphonez.
	La fonction mains-libres est activée.
	La sonnerie d'appel est désactivée.
	Le microphone est désactivé.
	Le verrouillage du clavier est activé.
	Indique le niveau actuel de chargement des piles.
12:10	Affichage de l'heure.
-1-	Numéros d'appel internes du combiné.

## - Téléphoner -

### 5 Téléphoner

#### 5.1 Représentations et notations

	Entrer des chiffres ou des lettres
2 sec	Appuyer sur la touche représentée pendant 2 secondes
	Signalisation vocale sur le combiné
EXEMPLE ou	Texte ou icônes sur l'écran

#### 5.2 Réceptionner des appels

,	Prendre une communication
	Terminer une communication

#### 5.3 Prendre deux appels

Des signaux sonores vous feront remarquer (signalisation d'appel en instance) qu'un autre appel vous parvient pendant que vous téléphonez. Vous pouvez passer d'un correspondant à l'autre.

R	2	Changer de correspondant
---	---	--------------------------



**Attention :** L'affichage du numéro d'appel, le maintien de communications et la signalisation d'appel en instance sont des services confort de votre opérateur. Veuillez lui demander de plus amples informations.



Demandez-lui quel temps de flash vous devez régler pour utiliser ces services.

#### 5.4 Comment téléphoner











	Entrer le numéro d'appel (max. 20 chiffres)
C	Si vous vous êtes trompé, effacez le dernier chiffre
	Composer le numéro

Vous pouvez également appuyez tout d'abord sur la touche de communication , vous obtenez ainsi la tonalité. Les chiffres du numéro que vous avez entrés sont immédiatement composés. Une correction de chiffres individuels n'est pas possible. Entrer le numéro d'appel (max. 30 chiffres).

## - Téléphoner -





### 5.5 Comment passer deux communications

Pendant une communication, vous pouvez composer un deuxième numéro d'appel. Le premier correspondant sera maintenu en ligne pendant que vous parlez avec l'autre. Vous pouvez sélectionner un enregistrement du répertoire ou entrer manuellement un numéro via le pavé numérique. Vous pouvez alors passer d'un correspondant à un autre.

	Appuyez sur cette touche pendant la communication
	Entrez le numéro à la main
<b>ou</b>	<b>ou</b>
	Appuyez sur cette touche pendant la communication
 ou 	Ouvrez le répertoire
 ou  , 	Sélectionnez l'enregistrement et confirmez
 , 	Changer de correspondant





### 5.6 Touche BIS

Votre téléphone enregistre les 10 derniers numéros composés dans une liste de répétition des derniers numéros.

	Ouvrez la liste de répétition automatique des derniers numéros
 ou  , 	Sélectionnez l'enregistrement et confirmez

### 5.7 Rappeler les appels manqués

Votre téléphone enregistre les 10 appels manqués dans une liste d'appels.

	Ouvrir la liste d'appels
 ou  , 	Sélectionnez l'enregistrement et confirmez

### 5.8 Numérotation en chaîne

La fonction de numérotation en chaîne est employée dans le cas de services de télécommunication plus complexes comme par ex. la banque par téléphone, l'appel par appel ou l'emploi de la carte pastel. Utilisez cette fonction pour transférer pendant une communication plusieurs numéros enregistrés dans votre répertoire. Vous pouvez combiner des transferts de numéros de votre répertoire avec des entrées de numéros à la main. Pendant une communication, vous pouvez numérotter en chaîne autant d'enregistrements de votre répertoire que vous désirez et les transférer.

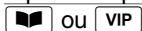

Ouvrez le répertoire pendant une communication



Sélectionnez un enregistrement et transférez un numéro

### 5.9 Numérotation par tonalité temporaire

Si vous ne pouvez faire fonctionner votre téléphone qu'avec une numérotation par IMPULSIONS, vous n'avez pas besoin de renoncer aux avantages de la numérotation par TONALITÉ (p. ex. : Interrogation d'un répondeur). Vous pouvez, pendant une communication, passer temporairement en numérotation par tonalité.



Appuyez pendant la communication sur

Quand la communication est terminée, la numérotation par IMPULSIONS est automatiquement rétablie.

### 5.10 Réglage du volume sonore de l'écouteur

Vous disposez de 5 niveaux pour régler le volume pendant une communication.



Appuyer pendant la communication sur

### 5.11 Mode mains-libres

Utilisez cette fonction pour téléphoner les mains libres.



Pressez dessus pour activer



Pressez dessus pour désactiver

## - Téléphoner -

### 5.12 Débrancher le microphone du combiné

Pendant une communication, vous pouvez débrancher et brancher le microphone.

 Appuyez dessus pour activer

 Appuyez dessus pour désactiver

### 5.13 Verrouillage du clavier

Lorsque le verrouillage du clavier est activé, vous pouvez réceptionner des appels entrants.

2 sec  0~/#  Appuyez dessus pour l'activer

2 sec  0~/# Appuyez dessus pour le désactiver

### 5.14 Mélodie de sonnerie d'appel du combiné

Vous pouvez désactiver la mélodie de sonnerie d'appel du combiné.



2 sec  \*/#  Appuyez dessus pour la désactiver

2 sec  \*/# Appuyez dessus pour l'activer

### 5.15 Affichage de sa durée

La durée d'une communication est affichée en heures, minutes et secondes.

### 5.16 Paging de la base au combiné

Appuyez sur la touche de paging   de la base pour entendre pendant 60 secondes les signaux d'appel du combiné. Appuyez à nouveau sur cette touche   ou sur la touche de communication   du combiné pour terminer la fonction avant l'expiration des 60 secondes.

## 6 Communication interne

 ,  , Appel intern ,

 , \_numéro

Composer le numéro d'appel interne du combiné



Prendre la communication



Terminer la communication



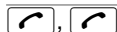

Si un appel externe vous parvient pendant une communication interne, vous entendez de courts signaux sonores et vous voyez à l'écran le numéro d'appel du correspondant si celui-ci est disponible.



Terminer la communication interne et réceptionner l'externe

### 6.1 Transférer des communications externes

Si vous avez pris une communication externe sur un combiné, vous pouvez la transférer sur un autre combiné.

 ,  , Appel intern ,

 , \_numéro

Pendant la communication, composer le numéro d'appel interne



Transférer la communication



Si le combiné appelé devait ne pas répondre, vous pouvez reprendre la communication externe au moyen de la touche .



### 6.2 Intercommunication / va-et-vient

Vous pouvez, pendant une communication externe, sélectionner un autre combiné pour intercommuniquer. Le correspondant externe est maintenu en ligne pendant que vous parlez avec le correspondant interne. Vous pouvez changer de correspondant autant de fois que vous le désirez.

 ,  , Appel intern ,

 , \_numéro



Pendant la communication, composer le numéro d'appel interne

 ,  , Va et vient , 

Passer d'un correspondant à l'autre

### **6.3 Comment mener des conférences téléphoniques**

Une communication externe peut être branchée sur un autre correspondant interne dans le but de mener une conférence.



MT1: , , Appel intern,

, \_numéro

Pendant la communication, composer le numéro d'appel interne

MT2: 

Prendre la communication en interne sur l'autre combiné

MT1: , Conférence, 

Démarrer la conférence

MT1 / MT2: 











La conférence se termine quand un correspondant interne raccroche



## **7 Navigation**

### **7.1 Navigation dans le menu**

Vous pouvez accéder à toutes les fonctions via différents menus. La structure de menu vous montre comment accéder à la fonction désirée.









1. Ouvrez le menu désiré ou le répertoire avec la touche adéquate.
2. Sélectionnez l'option avec la touche  ou .
3. Ouvrez l'option avec la touche .
4. Sélectionnez la fonction désirée avec la touche  ou .
5. Ouvrez la fonction avec la touche .
6. Sélectionnez le réglage désiré avec la touche  ou .
7. Entrez des chiffres ou des lettres via le pavé numérique.
8. Confirmez les entrées avec la touche .
9. Vous reculez d'une position avec la touche .
10. Avec la touche 2 sec  interrompez la programmation et la mémorisation et retournez au mode d'attente.



Chaque opération est automatiquement interrompue si vous n'effectuez pas de saisie dans les 30 secondes.



### **7.2 Exemple**















L'exemple "créer des enregistrements dans le répertoire" explique comment vous naviguez dans les menus et effectuez des entrées. Pour tous les réglages, procédez comme dans cet exemple.















	Ouvrez le répertoire
 ,  ou 	
Nouveau, 	Sélectionnez et confirmez la fonction
 , 	Entrez le numéro (max. 20 chiffres) et confirmez
 , 	Entrez le nom (max. 12 caractères) et confirmez

## 8 Structure du menu

### 8.1 Le menu principal

Vous accédez au menu principal en appuyant sur la touche . Sélectionnez l'option désirée avec les touches  ou .

BIS		Enregistrement 1		Sélectionner		
		Enregistrement 2		Enregistrer		# Nom 
		Enregistrement...		Effacer		Effacer? 
				Effacer list		Eff.liste? 

Journal		Enregistrement 1		Sélectionner		
		Enregistrement 2		Enregistrer		# Nom 
		Enregistrement...		Effacer		Effacer? 
				Effacer list		Eff.liste? 

\* Appel intern  # Numéro d'appel (interne) Cette fonction n'est disponible qu'en version Bundle.

Réglage comb		Mélodie sonn		Mélodie 1		
				Mélodie 2		
				Mélodie...		
		Volume sonn		Volume 1		
				Volume 2		
				Volume ...		
		DTMF		batt. Faible		Allume
						Eteint
				Hors. Portée		Allume
						Eteint
				Bip touche		Allume
						Eteint
						Eteint
		Langue		Allemand		
				Français		
				Italien		
		Réinitialise		Confirmez?		

Réglage base	☰	Modif. PIN	☰	☰ Code PIN	☰	☰ Nvx PIN	☰
▲						☰ Répét. PIN	☰
▼							
		Mode numerot	☰	Freq vocale	☰		
	▲						
	▼			DC	☰		
		Touche R	☰	80, 100, 120,	☰		
	▲			180, 250, 300,	☰		
	▼			600 ou 800 ms	☰		
		Code d'accès	☰	☰ Code d'accès	☰		
		Réinitialise	☰	☰ Entrer PIN	☰	Confirmez?	☰
Date / Heure	☰	☰ Année	☰	☰ Date	☰	☰ Heure	☰

## 8.2 Le répertoire

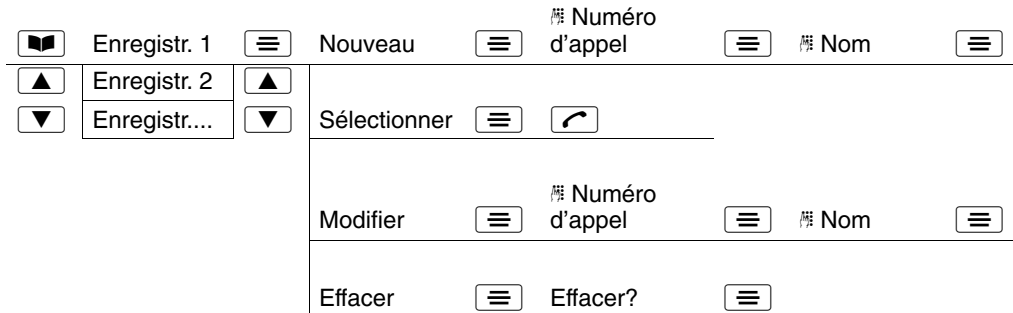

## 8.3 Le répertoire spécial<sup>1</sup>

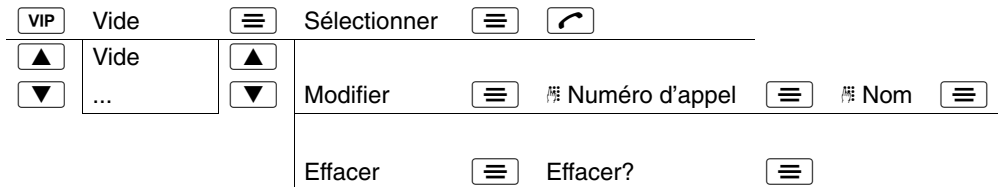

<sup>1</sup> Dans le répertoire spécial, les nouveaux enregistrements sont réalisés par l'intermédiaire du sous-menu "Modifier"

## **9 Explications**

### **9.1 Touche R sur les installations à postes supplémentaires**

Si votre téléphone est raccordé à une installation à postes supplémentaires, vous pouvez utiliser toutes les possibilités telles que transférer des appels, rappel automatique via la touche R (7.). Un temps de flash de 100 ms est nécessaire sur une installation à postes supplémentaires. Votre revendeur, chez lequel vous avez acheté l'installation, vous dira si votre téléphone fonctionne parfaitement sur ce genre d'installation.

### **9.2 Touche R et services confort**

Votre téléphone supporte les services confort les plus importants de votre opérateur (p. ex. va-et-vient, signalisation d'appel en instance, conférence à trois). Vous pouvez vous servir de la touche R (7.) si vous utilisez les services confort. Demandez à votre opérateur quel temps de flash vous devez régler pour les utiliser.

### **9.3 Affichage du numéro d'appel (CLIP)**

L'affichage du numéro d'appel est un service optionnel de votre opérateur. Veuillez lui demander de plus amples informations.

Si cette fonction est à votre disposition sur votre ligne téléphonique, l'écran vous indique le numéro du correspondant dès que le téléphone sonne. Si votre correspondant a bloqué la transmission de son numéro, l'écran affiche un message correspondant.

### **9.4 Appeler en interne**

Cette fonction n'est disponible qu'en version Bundle.

### **9.5 Réglages du combiné**

#### **9.5.1 Mélodie de sonnerie d'appel**

Vous pouvez régler 6 mélodies différentes sur votre combiné.

#### **9.5.2 Volume de la sonnerie**

Vous pouvez régler le volume de la sonnerie sur 5 niveaux.

#### **9.5.3 Signal sonore avertissant de la capacité des piles**

Lorsque la capacité des piles est très faible, le combiné émet des signaux sonores.

#### **9.5.4 Signal sonore avertissant de la portée**

Si vous vous êtes trop éloigné de la base, le combiné émet des signaux sonores.

#### **9.5.5 Son des touches**

Un son est produit par votre combiné à chaque fois que vous appuyez sur une touche.

#### **9.5.6 Réinitialisation du combiné**

Cette fonction permet de réinitialiser votre combiné sur les réglages en usine.

### **9.6 Réglages de la base**

#### **9.6.1 Code PIN**

Le code PIN peut se composer d'un nombre de 1 à 4 chiffres. Le réglage usine du code PIN est "0000". Si vous modifiez le code PIN, conservez bien le nouveau code. Si vous l'oubliez ou le perdez, adressez-vous à votre revendeur.

#### **9.6.2 Numérotation par tonalité (DTMF) ou par impulsions (IWV)**

Vous pouvez faire fonctionner votre téléphone à un raccordement analogique (IWV/IMPULSION) ou à un raccordement numérique (DTMF/TONALITÉ).

#### **9.6.3 Temps de flash**

Vous pouvez occuper la touche R (7.) avec 8 temps de flash différents pour utiliser des fonctions dans les installations à postes supplémentaires ou les services confort de votre opérateur.

#### **9.6.4 Code réseau**

Avec les installations à postes supplémentaires, vous devez composer un numéro déterminé pour obtenir une tonalité de la ligne principale. Vous pouvez enregistrer ce code réseau. Si votre téléphone reconnaît ce code réseau avant un numéro entré, une pause de numérotation est automatiquement insérée après ce code.

#### **9.6.5 Réinitialisation de la base**

Cette fonction permet de réinitialiser votre base sur les réglages usine. Vous devez entrer le code PIN pour exécuter cette dernière.

## **9.7 Répertoire**

Dans votre répertoire, vous pouvez enregistrer jusqu'à 20 numéros, y compris les noms. Dans le répertoire spécial, vous pouvez effectuer 10 enregistrements. Vous ne pouvez avoir accès à des enregistrements du répertoire qu'avec le combiné avec lequel ces derniers ont été créés. Les enregistrements du répertoire spécial peuvent être appelés de tous les combinés déclarés.

### **9.7.1 Entrer un nom**

Pour permettre la saisie de noms, des lettres sont inscrites sur les touches chiffrées. En appuyant plusieurs fois sur la touche adéquate, vous pouvez entrer des lettres, des chiffres et des symboles.

Pour saisir un espace, appuyez une fois sur la touche 1.

Pour entrer des symboles spéciaux, appuyez plusieurs fois sur la touche 0, touche 1 ou touche # jusqu'à ce que vous atteigniez ces symboles.

Pour passer de l'écriture majuscule à la minuscule, appuyez une fois sur la touche étoile.

Pour entrer deux fois la même lettre, appuyez sur la lettre adéquate. Attendez que le curseur passe derrière la lettre. Entrez la lettre à nouveau.

Si vous vous êtes trompé, vous pouvez effacer la dernière lettre avec la touche (12.).

### **9.7.2 Créer des enregistrements dans le répertoire**

Saisissez toujours les numéros d'appel avec l'indicatif afin que le téléphone puisse aussi attribuer les communications locales à un enregistrement du répertoire. Si la capacité de la mémoire du répertoire est atteinte, l'écran affiche un message correspondant lors de la prochaine sauvegarde. Pour créer de la place, vous devez tout d'abord effacer un autre enregistrement.

### **9.7.3 Sélectionner des numéros du répertoire**

Si vous vous trouvez dans le répertoire, vous pouvez sélectionner des enregistrements directement par ordre alphabétique. Pour cela, appuyez sur la touche avec l'initiale correspondante de votre enregistrement.

Sélectionnez un enregistrement du répertoire privé ou commun et établissez la communication avec la touche de communication (9.).



## **9.8 Réglages usine**

<b>Combiné</b>	<b>Base</b>
Volume de la sonnerie : 5	Code PIN : 0000
Mélodie de sonnerie d'appel : 1	Liste d'appels : Vide
Avertissement batterie: Marche	Numérotation : DTMF
Avertissement portée : Marche	Temps de flash : 100 ms
Son des touches : Marche	No accès: Vide
Volume sonore de l'écouteur : 3	
Volume sonore de l'écouteur : 3	
Verrouillage du clavier : Arrêt	
Liste de répétition automatique des derniers numéros : Vide	
Répertoire privé : Vide	

### 10 Elimination des perturbations

Si vous avez des problèmes avec votre téléphone, contrôlez d'abord les remarques suivantes. Si vous avez droit à des garanties, adressez-vous à votre revendeur.

<b>Erreurs</b>	<b>Solutions</b>
Pas de communication téléphonique possible	<ul style="list-style-type: none"><li>- Le câble du téléphone n'est pas correctement branché ou est soumis à des perturbations. N'utilisez que le câble de raccordement téléphonique fourni avec l'appareil.</li><li>- Testez avec un autre téléphone si votre raccordement téléphonique fonctionne.</li><li>- Le bloc d'alimentation n'est pas branché ou il y a une panne totale de courant.</li><li>- Les piles rechargeables sont vides ou défectueuses.</li><li>- Vous vous êtes trop éloigné de la base.</li></ul>
La liaison est hachée, coupée	<ul style="list-style-type: none"><li>- Vous vous êtes trop éloigné de la base.</li><li>- Mauvais lieu d'installation de la base.</li></ul>
Pas de numérotation possible	<ul style="list-style-type: none"><li>- Erreur de réglage du système de numérotation.</li></ul>
Le système ne réagit plus ou se trouve dans un état indéfini	<ul style="list-style-type: none"><li>- Remettez toutes les fonctions en configuration usine.</li><li>- Retirez un temps court le bloc d'alimentation de la prise de courant.</li></ul>
Le combiné se débranche de lui-même	<ul style="list-style-type: none"><li>- Placez le combiné pendant 14 heures sur la base. Renouvelez les piles.</li></ul>

## - *Elimination des perturbations* -

<b>Erreurs</b>	<b>Solutions</b>
Après le temps de chargement de 14 heures, l'écran affiche l'icône 	<ul style="list-style-type: none"><li>- Les piles rechargeables sont vides ou défectueuses.</li><li>- Placez le combiné correctement sur sa base. Nettoyez les surfaces de contact du combiné et de la base avec un chiffon doux et non pelucheux.</li></ul>
L'affichage de l'écran est sombre	<ul style="list-style-type: none"><li>- Causé par l'ensoleillement. Faites refroidir le combiné.</li></ul>
L'affichage du numéro d'appel (CLIP) ne fonctionne pas	<ul style="list-style-type: none"><li>- L'affichage du numéro d'appel est un service optionnel de votre exploitant de réseau. Veuillez lui demander de plus amples informations.</li><li>- Le correspondant a bloqué la transmission de son numéro d'appel.</li></ul>

## - Informations importantes -

### 11 Informations importantes

#### 11.1 Caractéristiques techniques

Caractéristique	Valeur
Standard	DECT
Alimentation en courant	Entrée : 220/230 V, 50 Hz Sortie : 6 V, 300 mA
Portée (à l'extérieur / à l'intérieur)	300 m, 50 m
Etat de veille	jusqu'à 100 h
Durée max. de communication	jusqu'à 10 h
Piles rechargeables standard	2 x 1.2 V/600 mAh, taille : AAA
Numérotation	Numérotation par tonalité (DTMF) Numérotation par impulsions (IWV)
Température ambiante autorisée	10°C à 30°C
Humidité atmosphérique relative autorisée	20% à 75%
Fonction de flash	80, 100, 120, 180, 250, 300, 600 ou 800 ms

F

DECT: **D**igital **E**uropean **C**ordless **T**elephone = Standard pour téléphones sans fil.

## **12 Index**

### **A**

Affichage du numéro d'appel, 44

Appeler en interne, 44

Appeler interne, 40

### **B**

batt. Faible, 41

Bip touche, 41

BIS, 40

### **C**

Caractéristiques techniques, 50

Chargement des piles, 33

Code d'accès, 42

Code PIN, 42, 45

Code réseau, 45

Composer des numéros d'appel du répertoire, 43

Composer le numéro de la journal, 40

Consignes de sécurité, 29

Contenu de l'emballage, 32

Créer des enregistrements dans le répertoire, 39, 43

Créer des enregistrements du répertoire, 46

### **D**

Date, 42

Débrancher le microphone, 38

DTMF, 41

Durée de la communication, 38

### **E**

Éléments de manipulation, 31

Élimination des perturbations , 48

Enregistrer le numéro de la journal, 40

Entrer un nom, 46

### **H**

Heure, 42

Hors. Portée, 41

### **J**

Journal, 40

### **L**

L'écran, 34

### **M**

Mélodie de sonnerie d'appel, 38, 41, 44

Mode mains-libres, 37

### **N**

Navigation, 39

Niveau de chargement des piles, 33

Notations, 35

Numérotation en chaîne, 37

Numérotation par tonalité temporaire, 37

### **P**

Paging, 38

Pause de numérotation, 45

Placer les piles, 32

## R

Raccorder la base, 32  
Réceptionner des appels, 35  
Réglage de la langue, 41  
Réglages combiné, 41  
Réglages de la base, 42, 45  
Réglages du combiné, 44  
Réglages usine, 47  
Réinitialisation de la base, 45  
Réinitialisation du combiné, 45  
Reinitialise, 41, 42  
Répertoire, 43, 46  
Répertoire spécial, 43, 46  
Représentations, 35

## S

Sélectionner des numéros du répertoire, 46  
Signal sonore avertissant de la capacité des piles, 44

Signal sonore avertissant de la portée, 45  
Son des touches, 45  
Système de numérotation, 45  
Système de numérotation par impulsions, 42, 45  
Système de numérotation par tonalité, 42, 45

## T

Téléphoner, 35  
Temps de flash, 42, 45  
Touche BIS, 36  
Touche R, 45  
Touche R et services confort, 44  
Touche R sur les installations à postes supplémentaires, 44

## V

Verrouillage du clavier, 38  
Volume de la sonnerie, 41, 44  
Volume sonore de l'écouteur, 37

**- Indice -**

1	Indicazioni di sicurezza .....	54
2	Elementi di comando .....	56
3	Avvio rapido .....	57
4	Display .....	59
5	Compiere telefonate .....	60
6	Navigazione .....	64
7	Struttura di menu .....	65
8	Spiegazioni .....	69
9	Eliminazione di errori .....	73
10	Informazioni importanti .....	75
11	Indice .....	76

## **1 Indicazioni di sicurezza**

Leggere attentamente le presenti istruzioni per l'uso.

### **1.1 Impiego conforme agli usi previsti**

Il presente apparecchio consente di compiere telefonate nell'ambito di una rete di telecomunicazione. Qualsiasi altro impiego è considerato come non conforme agli usi previsti. Non sono consentite modifiche o trasformazioni non autorizzate. Non aprire per nessuna ragione l'apparecchio autonomamente e svolgere riparazioni di propria iniziativa.

### **1.2 Luogo di installazione**

Il telefono è stato progettato per l'uso in campo chiuso con una temperatura compresa tra 10° C e 30° C. Si consiglia di evitare l'uso della stazione base in ambienti esposti a umidità come bagno e locali di lavaggio. Evitare pertanto un'esposizione a fumo, vibrazioni, sostanze chimiche, umidità, calore e raggi solari diretti. Posizionare la stazione base con una distanza di 1 m da altre apparecchiature elettroniche visto che altrimenti si possono verificare interferenze reciproche.

Evitare l'uso dell'unità portatile in aree esposte al rischio di deflagrazione.

### **1.3 Alimentatore di rete**



Utilizzare esclusivamente l'alimentatore a spina fornito in dotazione visto che altri alimentatori di rete potrebbero addirittura danneggiare il telefono. Non ostacolare il libero accesso all'alimentatore a spina con mobili o altri oggetti simili.

### **1.4 Cavo di collegamento telefonico**

Osservare un'identica disposizione degli attacchi in caso di sostituzione del cavo di collegamento telefonico fornito.

### **1.5 Batterie ricaricabili**

Non gettare le batterie nel fuoco, né sommergerle in acqua.

### **1.6 Caduta di tensione**

In caso di caduta di tensione non è possibile impiegare l'unità per telefonare. Si consiglia di ricorrere in caso di emergenza ad un telefono con filo in grado di funzionare anche senza alimentazione elettrica esterna.



### 1.7 Impianti telefonici interni

E' possibile collegare il telefono ad un impianto telefonico interno. **Non** è possibile garantire che il telefono acquistato funzioni in ogni caso con qualsiasi tipo di impianto telefonico interno.

### 1.8 Avvertenza per apparecchiature mediche

Evitare di utilizzare il telefono nelle vicinanze di apparecchiature mediche. Non è possibile escludere completamente il rischio di un influsso su cardiostimolatori. Telefoni DECT\* possono causare un fastidioso ronzio in apparecchi acustici.

### 1.9 Pulizia e cura

Pulire le superfici degli apparecchi con un panno morbido e antipilling. Non utilizzare mai detersivi o solventi. I piedini in gomma della stazione base non sono resistenti a qualsiasi detergente.

### 1.10 Smaltimento

La conversione della legislazione europea in leggi e direttive nazionali impone il corretto smaltimento di beni di consumo. Il simbolo riportato sul telefono e raffigurato qui a lato indica, che apparecchi usati elettrici ed elettronici e batterie esauste non sono da smaltire assieme ai normali rifiuti domestici.

Procedere allo smaltimento di **apparecchi elettrici o elettronici** presso un centro di raccolta incaricato con lo smaltimento conforme.

Consegnare **batterie ed accumulatori** per lo smaltimento presso i rivenditori al dettaglio di batterie o i centri di raccolta che mettono a disposizione appositi contenitori.

Smaltire **confezioni ed imballaggi** in base a quanto indicato dalle norme in vigore a livello locale.



\* DECT: Digital European Cordless Telephone = Standard per telefoni senza cavo.

## - Elementi di comando -

### 2 Elementi di comando

#### 2.1 Unità portatile

1. Display dot matrix
2. Tasto menu / Tasto OK
3. Scorrere in basso / L'elenco chiamate
4. Rubrica telefonica
5. Blocco tastiera
6. Rubrica telefonica speciale
7. Tasto R
8. Segnalazione acustica di chiamata ON / OFF
9. Tasto di chiamata
10. Funzione vivavoce ON / OFF
11. Scorrere in alto / Ripetizione di selezione
12. Cancellare / Silenziamento del microfono

#### 2.2 Stazione base

13. Tasto di ricerca unità portatile (tasto di paging)

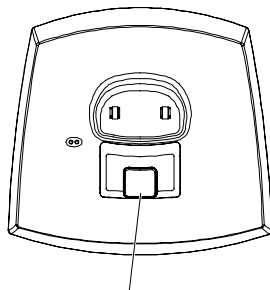
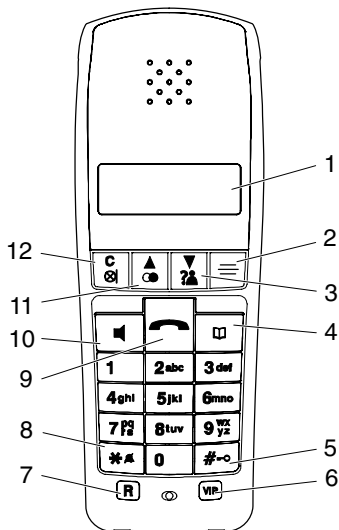

13

I tasti riportati nelle presenti istruzioni per l'uso sono raffigurati con un contorno uniforme. Con riserva di scostamenti per tasti e simboli visualizzati sul display del telefono rispetto a tasti e simboli di display qui raffigurati.

### 3 Avvio rapido

#### 3.1 Indicazioni di sicurezza



**Attenzione:** Prima della messa in funzione, leggere attentamente le indicazioni di sicurezza riportate al capitolo 1.

#### 3.2 Verificare il contenuto della confezione

La confezione contiene:

una stazione base con alimentatore di rete	un cavo di collegamento telefonico
un'unità portatile con gancio per cintura	due batterie ricaricabili
un manuale di istruzioni per l'uso	

#### 3.3 Collegare la stazione base

Procedere al collegamento della stazione base seguendo quanto raffigurato sul disegno. Utilizzare per motivi di sicurezza solo l'alimentatore di rete ed il cavo di collegamento telefonico forniti in dotazione.

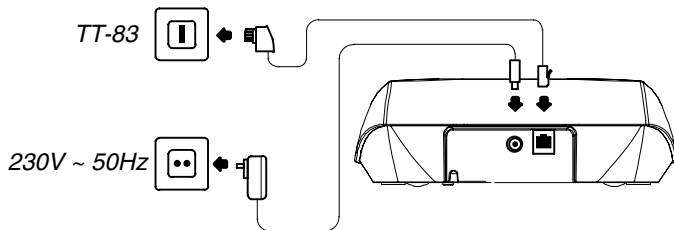



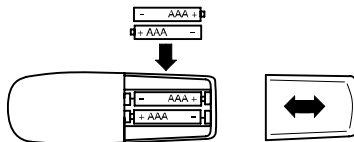

### 3.4 Inserire le batterie

Inserire le batterie nel rispettivo vano batterie aperto. Utilizzare a tale scopo solo batterie del tipo AAA Ni-MH 1,2 V 600 mAh. Osservare la corretta polarità! Chiudere quindi il vano batterie.



### 3.5 Caricare le batterie

Riporre l'unità portatile in sede di prima messa in funzione per una durata di minimo 14 ore nella stazione base. L'unità portatile si surriscalda durante il processo di carica. Questo è un fenomeno normale e non pericoloso. Evitare di caricare l'unità portatile con dispositivi di carica differenti o estranei. L'uso di batterie standard non ricaricate in maniera corretta può causare difetti o guasti al telefono. Lo **stato di carica** attuale è visualizzato sul display:

			
Carico	A metà	Debole	Scarico

### 3.6 Procedura di selezione a TONI (DTMF) o a IMPULSI (PSI)

Il telefono è collegabile sia a reti o allacciamenti analogici (selezione a impulsi/PSI) sia a reti o allacciamenti digitali (selezione a toni/DTMF). L'impostazione di base compiuta in fabbrica per l'apparecchio prevede la procedura di selezione a TONI (DTMF). Nel caso di mancato funzionamento del telefono presso il collegamento telefonico disponibile, è ad ogni modo possibile passare alla procedura di selezione a IMPULSI (PSI) seguendo le indicazioni riportate nel capitolo 8.1.

### 3.7 Impostare l'orario

Nel capitolo 8.1 sono riportate indicazioni relative all'impostazione dell'orario presso la propria unità portatile in sede di prima messa in funzione.

## 4 Display

Il display indica le funzioni più importanti attraverso simboli e messaggi vari.

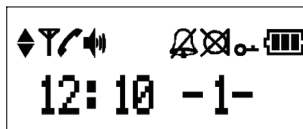







Simbolo	Descrizione
	Qui è possibile scorrere nel menu.
	Se la spia lampeggia: Il collegamento con la stazione base è interrotto. Se la spia rimane accesa: Il collegamento con la stazione base è buono.
	Chiamata telefonica in corso.
	Funzione vivavoce è attivata.
	La segnalazione acustica di chiamata è disattivata.
	Il microfono è disattivato.
	Il blocco tastiera è attivato.
	Indica lo stato di carica attuale delle batterie.
12:10	Indicazione dell'orario.
-1-	Numero di chiamata interno dell'unità portatile.

## - *Compiere telefonate* -

### 5 Compiere telefonate

#### 5.1 Rappresentazioni e modi di scrittura

	Immissione di numeri o lettere
2 sec  	Premere il tasto raffigurato per 2 secondi
	Segnalazione acustica presso l'unità portatile
 o 	Testo o simboli sul display

#### 5.2 Ricevere telefonate

 ,  o 	Ricevere la chiamata telefonica
	Concludere la chiamata

#### 5.3 Ricevere due chiamate

Dei segnali acustici indicano (avviso di chiamata) la ricezione di un'ulteriore chiamata durante lo svolgimento della prima telefonata. Il numero di passaggi della chiamata tra i due interlocutori di chiamata è illimitato.

 , 	Cambiare il partner di chiamata
---	---------------------------------







**Attenzione:** La visualizzazione del numero di chiamata, le funzioni di trattenimento e avviso di chiamate sono servizi a valore aggiunto del proprio gestore di rete telefonica. Si consiglia di rivolgersi al proprio gestore di rete telefonica per ricevere ulteriori informazioni a riguardo.



Si prega di consultare il proprio gestore di rete telefonica per ottenere informazioni sul tempo flash necessario per l'utilizzo dei servizi a valore aggiunto.

#### 5.4 Condurre telefonate

	Immettere un numero di chiamata (max. 20 cifre)
	In caso di immissione errata, cancellare l'ultima posizione
	Selezionare un numero di chiamata











E' altresì possibile premere prima il tasto di chiamata  e ricevere il segnale di linea libera. Il numero di chiamata immesso è subito

## - **Compiere telefonate** -

selezionato. Una correzione di singole cifre del numero di chiamata non è possibile. Immettere un numero di chiamata (max. 30 cifre).

### 5.5 **Condurre due telefonate**

Durante una chiamata in corso è possibile selezionare un secondo numero di chiamata. Mentre è in corso la conversazione con un altro interlocutore, la prima chiamata è trattenuta. E' possibile selezionare una voce dalla rubrica telefonica o immettere il numero di chiamata manualmente attraverso la tastiera del telefono. Il numero di passaggi della chiamata tra i due interlocutori di chiamata è illimitato.

	Premere con chiamata in corso
	Immettere il numero di chiamata manualmente
	Premere con chiamata in corso
 o 	Aprire la rubrica telefonica
 o  , 	Scegliere la voce e confermare
 , 	Cambiare il partner di chiamata





### 5.6 **Ripetizione di selezione**

Il telefono memorizza gli ultimi 10 numeri di chiamata selezionati in un elenco disponibile per la funzione di ripetizione di chiamata.

	Aprire l'elenco di ripetizione di chiamata
 o  , 	Scegliere la voce e instaurare un collegamento

### 5.7 **Selezionare numeri di chiamata persi**

Il telefono memorizza 10 chiamate perse nell'elenco chiamate.

	Aprire l'elenco chiamate
 o  , 	Scegliere la voce e instaurare un collegamento

### 5.8 Selezione a catena

La funzione di selezione a catena viene applicata per servizi telefonici più complessi come per es. banking via telefono, call by call o procedure con calling card. La funzione consente di trasmettere diversi numeri memorizzati nella rubrica telefonica con chiamata in corso. La trasmissione di numeri dalla rubrica telefonica è combinabile con l'immissione di numeri manuale. Con chiamata in corso è possibile combinare e trasmettere un numero illimitato di numeri tratti dalla rubrica telefonica.

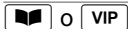

Aprire la rubrica telefonica con chiamata in corso



Scegliere una voce dell'elenco telefonico e trasmettere il numero

### 5.9 Selezione a toni temporanea

Qualora fosse possibile utilizzare il telefono soltanto con la procedura di selezione a IMPULSI, non sarà necessario rinunciare ai vantaggi della procedura di selezione a TONI (per es. interrogazione della segreteria telefonica). Durante una chiamata è infatti possibile passare temporaneamente alla procedura di selezione a TONI.



Premere con chiamata in corso

Alla fine della telefonata il telefono passa di nuovo automaticamente alla procedura di selezione a IMPULSI.

### 5.10 Impostare il volume del ricevitore

Il volume è regolabile durante lo svolgimento di una chiamata in cinque livelli.



Premere con chiamata in corso

### 5.11 Funzione vivavoce

Questa funzione consente di compiere telefonate a mani libere.



Premere per attivare



Premere per disattivare



## - **Compiere telefonate** -

### **5.12 Silenziamento del microfono nell'unità portatile**

E' possibile attivare e disattivare il microfono dell'unità portatile con chiamata telefonica in corso.

**C**  Premere per attivare

**C** Premere per disattivare

### **5.13 Blocco tastiera**

L'attivazione del blocco tastiera consente ad ogni modo di ricevere telefonate in arrivo come di consueto.

2 sec   Premere per attivare

2 sec  Premere per disattivare

### **5.14 Melodia di suoneria dell'unità portatile**

E' possibile disattivare la melodia di suoneria dell'unità portatile.



2 sec   Premere per disattivare

2 sec  Premere per attivare

### **5.15 Visualizzazione della durata di conversazione**



Durante lo svolgimento di una chiamata, la durata della telefonata è visualizzata in ore, minuti e secondi sul display.

### **5.16 Paging dalla stazione base all'unità portatile**

Premere sulla stazione base il tasto di paging , per 60 secondi si avvertono dei segnali acustici emessi dall'unità portatile. Premere di nuovo il tasto di paging  oppure il tasto di chiamata  sull'unità portatile per interrompere la funzione prima del trascorrere dei 60 secondi.

## - **Compiere chiamate interne** -

### 6 **Compiere chiamate interne**

, ,

,

Selezionare il numero di chiamata interno dell'unità portatile



Accettare la chiamata



Concludere la chiamata



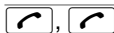

In caso di arrivo di una telefonata esterna durante la conduzione di una chiamata interna, si avvertono dei brevi segnali acustici ed il numero del chiamante, qualora disponibile, è visualizzato sul display.



Concludere una chiamata interna e accettare una chiamata esterna

#### 6.1 **Trasferire chiamate esterne**

Avendo accettato una chiamata esterna con una delle unità portatili, è possibile trasferire la chiamata esterna sull'altra unità portatile.

, ,

,

Selezionare il numero di chiamata interno con chiamata in corso





Trasferire la chiamata



Nel caso in cui l'unità portatile selezionata non dovesse rispondere, è possibile riprendere la chiamata esterna premendo il tasto .



#### 6.2 **Riscontro / Chiamata in attesa**

Durante lo svolgimento di una chiamata esterna è possibile chiamare un'altra unità portatile allo scopo di consultarsi o eseguire un riscontro. Mentre è in corso la conversazione con l'interlocutore interno, la chiamata esterna è trattenuta. Il numero di passaggi tra i partner di chiamata è illimitato.

, ,

,

Selezionare il numero di chiamata interno con chiamata in corso

, ,  , 

Passare da un partner di chiamata all'altro

## - **Compiere chiamate interne** -

### 6.3 **Compiere chiamate a conferenza**

Questa funzione consente di condurre una conferenza con una chiamata esterna ed un altro interlocutore interno.



MT1: , , ,

,

Selezionare il numero di chiamata interno con chiamata in corso

MT2: 

Ricevere la chiamata interna presso l'altra unità portatile

MT1: , , 

Avviare la conferenza











MT1 / MT2: 

La conferenza è conclusa nel momento in cui uno dei partner di chiamata interni conclude la chiamata

## **7 Navigazione**

### **7.1 Navigazione nel menu**

I differenti menu consentono di raggiungere tutte le funzioni del telefono. Il percorso da seguire per giungere alla funzione desiderata è indicato dalla struttura di menu.

1. Aprire il menu desiderato o la rubrica telefonica con il rispettivo tasto.
2. Selezionare con il tasto  o  il sottomenu desiderato.
3. Aprire con il tasto  il sottomenu.
4. Selezionare con il tasto  o  la funzione desiderata.
5. Aprire con il tasto  la funzione.
6. Selezionare con il tasto  o  l'impostazione desiderata.
7. La tastiera consente di immettere numeri o lettere.
8. Confermare con il tasto  le immissioni.
9. Con il tasto  si torna rispettivamente indietro di un livello.
10. Con il tasto 2 sec  si interrompono le procedure di programmazione e memorizzazione facendo ritorno alla modalità di stand-by.



Ogni singolo processo si interrompe automaticamente se entro 30 secondi non si procede con una immissione.

### **7.2 Esempio**

La procedura da seguire per navigare nei menu e compiere immissioni è indicata con l'esempio "Immettere voci nella rubrica telefonica". Si consiglia di seguire quest'esempio per tutte le altre impostazioni che si desidera compiere.



Aprire la rubrica telefonica



Nuovo



Selezionare e confermare la funzione





Immettere e confermare il numero di chiamata (max. 20 cifre)































Immettere e confermare il nome (max. 12 posizioni)

## 8 Struttura di menu











































### 8.1 Il menu principale

Nel menu principale si giunge premendo il tasto . Scegliere con i tasti  o  il sottomenu desiderato.

Lista RP		Voce 1		Selezionare			
		Voce 2		Memorizza		☎ Nome	
		Voce ...		Cancella		Cancella?	
				Canc. Lista		Cancella?	

Lista CID		Voce 1		Scegliere			
		Voce 2		Memorizza		☎ Nome	
		Voce ...		Cancella		Cancella?	
				Canc. Lista		Cancella?	

\* Intercom  ☎ Numero di chiamata (interno) \* Questa funzione è disponibile solo nella versione "bundle".

Imposta port		Melodia		Melodia 1			
				Melodia 2			
				Melodia ...			
		Volume		Volume 1			
				Volume 2			
				Volume ...			
		Toni		Batterie		Acceso	
						Spento	
						Spento	
				Fuori campo		Acceso	
							
						Spento	
				Toni tasti		Acceso	
							
						Spento	
		Lingua		Tedesco			
				Francese			
				Italiano			
		Reset		Reset?			

Imposta base		Cambia PIN		Ins PIN		Nuovo PIN	
						Ripeti PIN	
		Modo selez.		Multifreq			
				Decadica			
		Tempo flash		80, 100, 120,			
				180, 250, 300,			
				600 o 800 ms			
		codice PABX		Numero di accesso alla rete esterna			
		Reset		Ins PIN		Reset?	
Data / Ora		Anno		Data		Orario	





## 8.2 La rubrica telefonica

	Voce 1		Nuovo		Numero di chiamata		Nome	
	Voce 2							
	Voce ...		Selezionare					
			Modifica		Numero di chiamata		Nome	
			Cancella		Cancella?			

## 8.3 La rubrica telefonica speciale<sup>1</sup>

	Vuoto		Selezionare					
	Vuoto							
	...		Modifica		Numero di chiamata		Nome	
			Cancella		Cancella?			

<sup>1</sup> Per creare nuove voci nella rubrica telefonica speciale, passare al sottomenu "Modifica".



## **9 Spiegazioni**

### **9.1 Tasto R in impianti telefonici interni**

Avendo collegato il telefono ad un impianto telefonico interno, il tasto R (7.) consente di accedere a tutte le altre funzioni disponibili come per es. trasferimento di chiamata, funzione di richiamata automatica e così via. Per operare in un impianto telefonico interno è necessario impostare un tempo flash di 100 ms. Il rivenditore specializzato è in grado di indicare se il telefono acquistato funzionerà senza alcun problema nel proprio impianto telefonico interno.

### **9.2 Tasto R e servizi a valore aggiunto**

Il telefono supporta i più importanti servizi a valore aggiunto del proprio gestore di rete telefonica (per es. funzioni di chiamata in attesa, avviso di chiamata, conferenza a tre). Il tasto R (7.) è disponibile utilizzando i servizi a valore aggiunto. Si prega di consultare il proprio gestore di rete telefonica per ottenere informazioni sul tempo flash necessario per l'utilizzo dei servizi a valore aggiunto.

### **9.3 Visualizzazione del numero di chiamata (CLIP)**

La visualizzazione del numero di chiamata è un servizio opzionale offerto dal proprio gestore di rete telefonica. Si consiglia di rivolgersi al proprio gestore di rete telefonica per ricevere ulteriori informazioni a riguardo.

A condizione che la linea telefonica offra questa funzione, sul display LCD sarà visualizzato il numero del chiamante non appena il telefono squilla. Nel caso in cui il chiamante abbia soppresso la trasmissione del proprio numero di chiamata, sul display appare un'apposita indicazione.

### **9.4 Compiere chiamate interne**

Questa funzione è disponibile solo nella versione "bundle".

### **9.5 Impostazioni unità portatile**

#### **9.5.1 Melodia di suoneria**

L'unità portatile consente di impostare fino a 6 melodie di suoneria differenti.

#### **9.5.2 Volume della segnalazione di chiamata**

E' possibile impostare il volume della segnalazione acustica di chiamata in 5 livelli.

### **9.5.3 Segnale di avviso batteria**

Con uno stato di carica delle batterie molto scarso, l'unità portatile emette dei suoni di avviso.

### **9.5.4 Segnale di avviso portata**

Non appena ci si allontana troppo dalla stazione base, l'unità portatile emette degli appositi suoni di avviso.

### **9.5.5 Suono tasti**

Ogni volta che si preme un tasto, l'unità portatile emette un suono.

### **9.5.6 Ripristinare unità portatile**

Con questa funzione l'unità portatile è ripristinata e l'apparecchio torna alle impostazioni di fabbrica.

## **9.6 Impostazioni stazione base**

### **9.6.1 Codice PIN**

Il codice PIN può essere composto da fino a quattro cifre numeriche. L'impostazione di default del codice PIN corrisponde a "0000". Si consiglia di conservare con cura il nuovo codice PIN in caso di modifica del codice preimpostato. Avendo dimenticato o smarrito il codice PIN, si prega di rivolgersi al proprio rivenditore autorizzato.

### **9.6.2 Procedura di selezione a toni (DTMF) o a impulsi (PSI)**

Il telefono è collegabile sia a reti o allacciamenti analogici (IMPULSI/PSI) sia a reti o allacciamenti digitali (TONI/DTMF).

### **9.6.3 Tempo flash**

Sul tasto R (7.) sono programmabili 8 tempi flash differenti per poter usufruire di funzioni in impianti telefonici interni o dei servizi a valore aggiunto del proprio gestore di rete telefonica.

### **9.6.4 Numero di accesso alla rete esterna**

In presenza di impianti telefonici interni è necessario selezionare un determinato numero prima di ottenere un segnale di libero che indica la disponibilità della linea di collegamento di rete. Questo numero di accesso alla rete esterna è memorizzabile. Non appena il telefono riconosce il numero di accesso alla rete esterna immesso prima del numero di chiamata vero e proprio, subito dopo la selezione del numero di accesso alla rete esterna viene automaticamente osservata una pausa di selezione.

### **9.6.5 Ripristino stazione base**

Con questa funzione la stazione base è ripristinata e l'apparecchio torna alle impostazioni di fabbrica. Per svolgere la funzione è necessaria l'immissione del codice PIN.

### **9.7 Rubrica telefonica**

Nella rubrica telefonica è possibile memorizzare 20 numeri di chiamata inclusi i rispettivi nomi. Nella rubrica telefonica speciale sono memorizzabili 10 voci. Le voci memorizzate nella rubrica telefonica sono accessibili solo per l'unità portatile con la quale sono state compiute le immissioni. Le immissioni compiute nella rubrica telefonica speciale sono invece disponibili per tutte le unità portatili registrate.

#### **9.7.1 Immettere nomi**

L'immissione di un nome viene eseguita utilizzando le lettere indicate sui tasti numerici del telefono. Premendo ripetutamente il tasto relativo, si ha modo di selezionare lettere, cifre e caratteri speciali.

Per immettere uno spazio vuoto, premere una volta il tasto 1.

Per immettere caratteri speciali, premere ripetutamente il tasto 0, tasto 1 o tasto # fino a raggiungere il carattere speciale desiderato.

Per passare dall'immissione di lettere maiuscole a lettere minuscole, premere una volta il tasto asterisco.

Per immettere la stessa lettera una seconda volta, premere la rispettiva lettera. Attendere fino a quando il cursore si sposta di una posizione. Immettere quindi la lettera una seconda volta.

In caso di immissioni errate, procedere a cancellazione dell'ultima posizione con il tasto (12.).

#### **9.7.2 Immettere voci nella rubrica telefonica**

I numeri di chiamata dovranno essere immessi sempre con il rispettivo prefisso, cosa che consente di assegnare anche ai numeri di chiamate urbane una delle voci dell'elenco telefonico. Una volta esaurita la capacità di memoria della rubrica telefonica, sul display appare un messaggio di avviso non appena si volesse procedere con un'ulteriore immissione. Per ottenere nuovo spazio di memoria è quindi necessario cancellare prima una delle voci presenti nella rubrica telefonica.

### **9.7.3 Selezionare numeri dalla rubrica telefonica**

Nella rubrica telefonica le voci possono essere selezionate direttamente in ordine alfabetico. Premere a tale scopo il tasto con la lettera iniziale della rispettiva voce dell'elenco telefonico.

Scegliere una voce dalla rubrica telefonica privata oppure dalla rubrica telefonica comune e instaurare un collegamento premendo il tasto di chiamata (9.).

### **9.8 Impostazioni di fabbrica**

<b>Unità portatile</b>	<b>Stazione base</b>
Volume della segnalazione di chiamata: 5	Codice PIN: 0000
Melodia di suoneria: 1	Elenco chiamate: Vuoto
Segnale di avviso batteria: ON	Procedura di selezione: DTMF / A toni
Segnale di avviso portata: ON	Tempo flash: 100 ms
Suono tasti: ON	Numero di accesso alla rete esterna: Vuoto
Volume del ricevitore: 3	
Volume dell'altoparlante: 3	
Blocco tastiera: OFF	
Elenco di ripetizione di chiamata: Vuoto	
Rubrica telefonica privata: Vuoto	

## **10 Eliminazione di errori**

In presenza di problemi con il telefono, seguire le indicazioni riportate qui di seguito. In caso di reclami entro il periodo di garanzia, rivolgersi al rivenditore autorizzato.

<b>Errore</b>	<b>Soluzione</b>
Non è possibile condurre una chiamata telefonica	<ul style="list-style-type: none"><li>- La linea telefonica non è collegata correttamente oppure presenta un guasto. Utilizzare esclusivamente il cavo di collegamento telefonico fornito.</li><li>- Provare con un altro telefono se l'allacciamento telefonico in questione è funzionante.</li><li>- L'alimentatore di rete non è inserito oppure si è in presenza di una caduta di tensione totale.</li><li>- Le batterie ricaricabili sono scariche o difettose.</li><li>- La distanza dalla stazione base è troppo grande.</li></ul>
Collegamento disturbato, si interrompe	<ul style="list-style-type: none"><li>- La distanza dalla stazione base è troppo grande.</li><li>- Luogo di installazione della stazione base errato.</li></ul>
Non è possibile compiere una selezione	<ul style="list-style-type: none"><li>- Impostazione errata della procedura di selezione.</li></ul>
Il sistema non reagisce più oppure è in uno stato indefinito	<ul style="list-style-type: none"><li>- Ripristinare le impostazioni di default per tutte le funzioni.</li><li>- Estrarre brevemente l'alimentatore di rete dalla presa di corrente.</li></ul>
L'unità portatile si spegne automaticamente	<ul style="list-style-type: none"><li>- Riporre l'unità portatile per la durata di 14 ore nella stazione base. Sostituire le batterie ricaricabili.</li></ul>



## - Eliminazione di errori -

<b>Errore</b>	<b>Soluzione</b>
Dopo una durata di carica di 14 ore, il display continua ad indicare il simbolo 	<ul style="list-style-type: none"><li>- Le batterie ricaricabili sono scariche o difettose.</li><li>- Riporre l'unità portatile correttamente nella stazione base. Pulire le superfici di contatto di unità portatile e stazione base con un panno morbido e asciutto.</li></ul>
Visualizzazione sul display è scura	<ul style="list-style-type: none"><li>- Il difetto è causato da raggi del sole diretti. Fare raffreddare l'unità portatile.</li></ul>
La visualizzazione del numero di chiamata (CLIP) non funziona	<ul style="list-style-type: none"><li>- La visualizzazione del numero di chiamata è un servizio opzionale offerto dal proprio gestore di rete telefonica. Si consiglia di rivolgersi al proprio gestore di rete telefonica per ricevere ulteriori informazioni a riguardo.</li><li>- Il chiamante ha disattivato la trasmissione del proprio numero di chiamata.</li></ul>

## - Informazioni importanti -

### 11 Informazioni importanti

#### 11.1 Specifiche tecniche

Caratteristica	Valore
Standard	DECT
Alimentazione elettrica	Entrata: 220/230 V, 50 Hz Uscita: 6 V, 300 mA
Distanza (esterni/interni)	300 m, 50 m
Autonomia di stand-by	fino a 100 ore
Autonomia di chiamata	fino a 10 ore
Batterie standard ricaricabili	2 x 1.2 V/600 mAh, tipo: AAA
Procedura di selezione	Procedura di selezione a TONI (DTMF) Procedura di selezione a IMPULSI (PSI)
Temperatura ambiente consentita	10°C fino 30°C
Umidità atmosferica relativa consentita	da 20% a 75%
Funzione flash	80, 100, 120, 180, 250, 300, 600 o 800 ms

DECT: **D**igital **E**uropean **C**ordless **T**elephone = Standard per telefoni senza cavo.

## **12 Indice**

### **B**

Blocco tastiera, 63

### **C**

Caricare le batterie, 58  
Codice PIN, 67, 70  
Collegare la stazione base, 57  
Compiere chiamate interne, 65, 69  
Compiere telefonate, 60  
Contenuto della confezione, 57

### **D**

Data, 67  
Display, 59  
Durata di conversazione, 63

### **E**

Elementi di comando, 56  
Eliminazione di errori, 73

### **F**

Funzione vivavoce, 62

### **I**

Immettere nomi, 71  
Immettere voci nella rubrica telefonica, 64, 68, 71  
Impostare la lingua, 66  
Impostazioni dell'unità portatile, 66, 69  
Impostazioni della stazione base, 67, 70  
Impostazioni di fabbrica, 72  
Indicazioni di sicurezza, 54  
Inserire le batterie, 57

### **L**

Lista CID, 65

### **M**

Melodia di suoneria, 63, 66, 69  
Memorizzare numeri dall'elenco chiamate nella rubrica telefonica, 65  
Modi di scrittura, 60

### **N**

Navigazione, 64  
Numero di accesso alla rete esterna, 67, 70

### **O**

Orario, 67

### **P**

Paging, 63  
Pausa di selezione, 70  
Procedura di selezione, 70  
Procedura di selezione a impulsi, 67, 70  
Procedura di selezione a toni, 67, 70

### **R**

Rappresentazioni, 60  
Reset dell'unità portatile, 66  
Reset della stazione base, 67  
Ricevere telefonate, 60  
Ripetizione di selezione, 61, 65  
Ripristino dell'unità portatile, 70  
Ripristino della stazione base, 71  
Rubrica telefonica, 68, 71  
Rubrica telefonica speciale, 68, 71



**S**

Segnale di avviso batteria, 66, 70  
Segnale di avviso portata, 66, 70  
Selezionare numeri dalla rubrica telefonica, 68, 72  
Selezionare un numero dall'elenco chiamate, 65  
Selezione a catena, 62  
Selezione a toni temporanea, 62  
Silenziamiento del microfono, 63  
Specifiche tecniche, 75  
Stato di carica delle batterie, 58  
Suono tasti, 66, 70

**T**

Tasto R, 70  
Tasto R e servizi a valore aggiunto, 69  
Tasto R in impianti telefonici interni, 69  
Tempo flash, 67, 70

**V**

Visualizzazione del numero di chiamata, 69  
Volume del ricevitore, 62  
Volume della segnalazione di chiamata, 66, 69

**- Contents -**

1	Safety Information .....	82
1	Safety Information .....	79
2	Operating Elements .....	81
3	Starting Up .....	82
4	Display .....	84
5	Telephoning .....	85
6	Navigation .....	89
7	Menu Structure .....	90
8	Explanations .....	94
9	Troubleshooting .....	98
10	Important Information .....	100
11	Index .....	101

## **1 Safety Information**

Please read this operating instruction manual thoroughly.

### **1.1 Intended use**

The telephone is suitable for telephoning within a public telephone network system. Any other use is considered unintended use. Unauthorised modification or reconstruction is not permitted. Under no circumstances open the device or complete any repair work yourself.

### **1.2 Installation location**

The telephone is designed for use indoors in rooms with a temperature range from 10 °C to 30 °C. The base station should not be used in rooms exposed to moisture, such as bathrooms or laundries. Prevent excessive exposure to smoke, dust, vibration, chemicals, moisture, heat and direct sunlight. Position the base station with a distance of 1 m to other electronic devices or there is a risk of mutual disturbance.

Do not use the handset in potentially explosive areas.

### **1.3 Power supply**



Only use the power adapter plug supplied because other power supplies could destroy the telephone. Ensure access to the power adapter plug is not obstructed by furniture or such.

### **1.4 Telephone connection cable**

If the telephone connection cable supplied needs to be replaced, ensure the pin assignment is identical on the new one.

### **1.5 Rechargeable batteries**

Do not throw batteries into a fire or immerse them in water.

### **1.6 Power failure**

The telephone cannot be used to make calls in the event of a power failure. Always keep a cord connected telephone which operates without an external power supply available in case of emergency situations.

### **1.7 Private branch exchanges**

The telephone can be connected to a private branch exchange. There is **no** guarantee that the telephone will work on every private branch exchange.

## - Safety Information -

### 1.8 Notes on medical equipment

Never use the telephone in the vicinity of medical equipment. It cannot be fully ruled out that they will not affect heart pacemakers. DECT\* telephones can cause an unpleasant humming sound in hearing aids.

### 1.9 Cleaning and upkeep

Clean the housing surfaces with a soft, fluff-free cloth. Never use cleaning agents or solvents. The rubber footpads on the base station are not resistant to all cleaning agents.

### 1.10 Disposal

You are legally obliged to dispose of consumable goods according to the applicable laws. The adjacent symbol on the telephone indicates that electrical and electronic apparatus and batteries no longer required must be disposed of separate from domestic waste.



**Electrical and electronic devices** must be disposed of at a suitable collection point provided by the public waste authorities.



**Batteries** must be disposed of at the point of sale or at the appropriate collection points provided by the public waste authorities.

**Packaging materials** must be disposed of according to local regulations.

\* DECT: **D**igital **E**uropean **C**ordless **T**elephone = Standard for cordless telephones.

## 2 Operating Elements

### 2.1 Handset

1. Dot-matrix display
2. Menu button / OK button
3. Scroll downwards / Calls list
4. Phone book
5. Key lock
6. VIP phone book
7. R-button
8. Ringing tone on/off
9. Call button
10. Handsfree on/off
11. Scroll upwards / Redial
12. Delete (clear) / Mute

### 2.2 Base station

13. Paging button (locate handset)

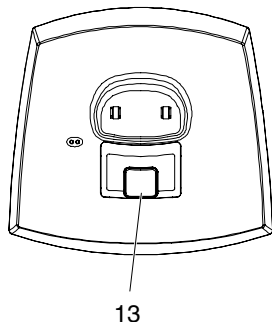
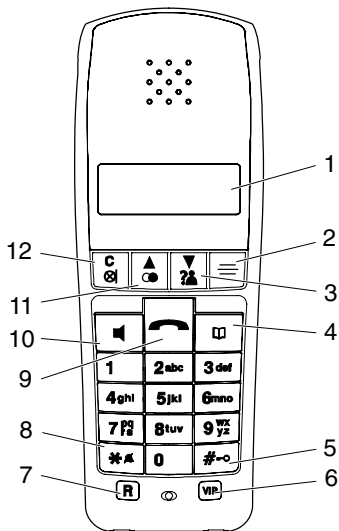

The buttons in this operating manual are depicted with a uniform contour. Variations in the symbols on the telephone buttons compared to those depicted here are possible.

## 3 Starting Up

### 3.1 Safety information



**Caution:** It is essential to read the Safety Information in Chapter 1 before starting up.

### 3.2 Checking the contents of the package

The package contains:

a base station with power adapter plug with cable	a telephone connection cable
a handset with belt clip	two rechargeable batteries
an operating manual	

### 3.3 Connecting the base station

Connect the base station as illustrated in the diagram. For reasons of safety, only use the power adapter plug and telephone connection cable supplied.

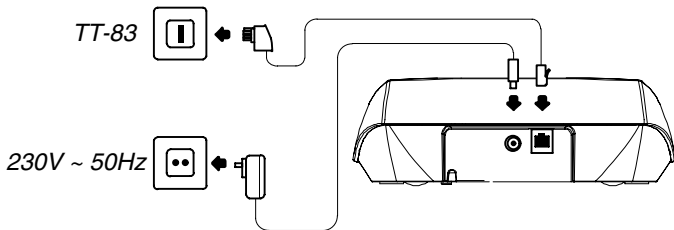



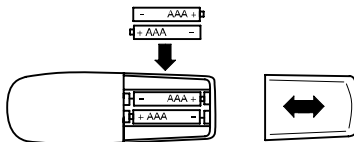

### 3.4 Inserting the batteries

Insert the “AAA” batteries in the open battery compartment. Only use batteries of the type AAA Ni-MH 1.2 V 600 mAh. Pay attention to correct polarity. Close the battery compartment cover.



### 3.5 Charging the batteries

Before the handset is used for the first time, insert it in the base station for at least 14 hours. The handset warms up during the charging process. This is normal and does not represent a risk. Do not charge the handset with charging units from other manufacturers. Failure to charge the batteries properly can lead to telephone malfunction. The current **battery charge status** is indicated in the display:

			
Full	Half empty	Weak	Empty

### 3.6 Tone or Pulse dialling mode

The telephone can be connected to both analogue connections (pulse dialling) and digital connections (tone dialling/DTMF). The equipment is set to TONE dialling (DTMF) at the factory. If the telephone does not work on your telephone connection, refer to Chapter 8.1 to learn how to switch the telephone to pulse dialling.

### 3.7 Setting the time

Chapter 8.1 explains how to set the time on the handset when starting it up for the first time.

## 4 Display

The display indicates all the important functions by means of various icons and messages.

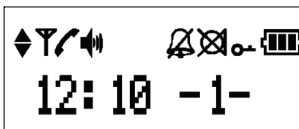





Icon	Description
	You can scroll through the menu.
	Flashing: The connection to the base station is poor. Continuously on: The connection to the base station is good.
	A call is currently being made.
	Handsfree mode has been switched on.
	The ringing tone has been switched off.
	The microphone is switched off.
	The key lock function is switched on.
	Indicates the current battery charge status.
12:10	Time display.
-1-	Internally assigned call number of the handset.





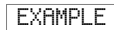

## - Telephoning -

### 5 Telephoning

#### 5.1 Display and explanation of operation sequences



	Enter digits or letters
2 sec 	Press the button depicted for 2 seconds
	Acoustic signal on the handset
 EXAMPLE or 	Text or icon in the display

#### 5.2 Taking a call

 ,  or 	Take the call
	End the call

#### 5.3 Taking two calls

You will hear acoustic signals (call waiting) if a second call is received while you are carrying out a telephone conversation. It is possible to switch between the two callers.

 , 	Switch to other caller
--	------------------------







**Caution:** The functions for phone number display, holding calls and call waiting are supplementary services offered by your telephone network provider. Contact your network provider for further information.



Please contact your telephone network provider regarding which recall (Flash) time must be set to use the supplementary services.

#### 5.4 Making a call

	Enter the phone number (max. 20 digits)
	Delete the last digit if incorrect
	Dial the phone number

It is also possible to press the Call button  first to obtain the dialling tone for an outside line. The phone number then entered is dialled immediately. It is not possible to correct wrong digits. Using this dialling procedure allows you to enter phone numbers up to 30 digits.

## - Telephoning -

### 5.5 Making two calls



It is possible to dial a second number while making a call. The first caller is put on hold while you converse with the second person called. You can select a phone book entry or enter a number manually using the digit keys. It is possible to switch between the two callers.



 Press the button during the call



 Enter the phone number manually

or

 Press the button during the call

 or  Open the phone book



 or ,  Select an entry and confirm

,  Switch to other caller

### 5.6 Redialling

The telephone stores the last ten numbers dialled in a redialling list.



 Open the redialling list

 or ,  Select an entry and dial the number

### 5.7 Calling back missed numbers



The telephone stores the last ten numbers not taken in a calls log.



 Open the calls log

 or ,  Select an entry and dial the number

### 5.8 Chain dialling

The chain dialling function is used in more complex telephone services, e.g. for telephone banking, call-by-call or calling card procedures. The function is used to transfer numbers stored in the phone book when a connection has already been made. It is also possible to combine numbers for transfer from the phone book with numbers entered manually. Numbers stored in the phone book can be chained and transmitted as required.

 or  Open the phone book when a connection has been made

 or ,  Select the phone book entry and transmit the number

## - Telephoning -

### 5.9 Temporary tone dialling





If you only operate the telephone using the PULSE dialling mode, you can still make use of the advantages of the TONE dialling mode (e.g.: remote access of the answering machine). During a call, you can temporarily switch to Tone dialling.

1 sec   Press the button during the call

When the call is ended, the equipment automatically switches back to Pulse dialling.



### 5.10 Adjusting the receiver volume

The volume can be adjusted to one of five settings during a call.

 or   to  
,  Press the buttons during the call

### 5.11 Handsfree



Use this function to telephone with your hands free.

  Press the buttons to activate the function

 Press the button to deactivate the function

### 5.12 Muting the microphone in the handset



The microphone in the handset can be activated and deactivated during a telephone conversation.

  Press the buttons to activate the function

 Press the button to deactivate the function

### 5.13 Key lock



Calls can still be taken in the normal way even when the key lock function is activated.

2 sec   Press the buttons to activate the function

2 sec  Press the buttons to deactivate the function

### **5.14 Handset ringing melody**

The ringing melody on the handset can be switched off.

2 sec  

Press the buttons to deactivate the function



2 sec 

Press the button to activate the function

### **5.15 Talk time display**



The duration of a call is displayed in hours, minutes and seconds during the call.

### **5.16 Paging the handset from the base station**

Press the Paging button  on the base station; the handset rings for 60 seconds. Press the Paging button  or Call button  on the handset to end the function before the 60 seconds has expired.

## 6 Internal Calls

---

, , ,  
,  Dial the internally assigned handset number

---

 Take the call



---

 End the call

---

 If an external call is received during an internal call, you hear short acoustic signals and the caller's number appears in the display, if available.

---



,  End the internal call and take the external call

---

### 6.1 Forwarding external calls

If you have taken an external call on a handset, the call can be transferred to another handset.



---

, , ,  
,  Dial the internal handset number during the call

---

 Forward the call

---



 If the handset called does not answer, take the external call back by pressing the  button.

---

### 6.2 Holding a call / brokering

While a call is in progress, it is possible to dial another handset in order to consult with someone. The external caller is put on hold while you converse with the second, internal person called. You can switch between the callers as often as necessary.

---

, , ,  
,  Dial the internal handset number during the call

---

, , ,  Switch between the callers

---

## - Internal Calls -

### 6.3 Conference calls

An external call can be linked to another internal handset for a conference call.

MT1: , ,

,

Dial the internal handset number during the call

MT2: 

Take the call on the other handset

MT1: , , 

Start the conference call











MT1 / MT2: 

The conference is terminated by one of the internal handset users ending the call

## 7 Navigation

### 7.1 Navigating in the menu

All the functions can be accessed via the various menus. Refer to the menu structure to find how to access the respective functions.







1. Open the required menu or phone book using the relevant button.
2. Press  or  to select the required submenu.
3. Press the  button to open the submenu.
4. Press  or  to select the required function.
5. Press the  button to open the function.
6. Press  or  to select the setting required.
7. Enter digits or letters using the relevant digit keys.
8. Press the  button to confirm the input.
9. Press the  button to move one level back.
10. Press the  button for 2 sec. to cancel the programming and storing process and return to Standby mode.



Every process is automatically cancelled if there is no input within 30 seconds.



### 7.2 Creating a phone book entry - example















The way in which to navigate through the menus and enter data is explained by means of the example "Creating a phone book entry". Proceed as in this example for all the settings.















	Open the phone book
 ,  or  Neu, 	Select the function and confirm
Num, 	Enter the phone number (max. 20 digits) and confirm it
Num, 	Enter the name (max. 12 characters) and confirm

## 8 Menu Structure

### 8.1 Main menu

Access the Main menu by pressing the  button. Use the  or  button to scroll to and select the required submenu.

Redial.		Eintrag 1		Auswählen		
		Eintrag 2		Nr. speichern		 Name 
		Eintrag ...		Löschen		Löschen? 
				Liste lösch.		Liste lösch? 

Anrufliste		Eintrag 1		Auswählen		
		Eintrag 2		Nr. speichern		 Name 
		Eintrag ...		Löschen		Löschen? 
				Liste lösch.		Liste lösch? 

\* Intern anr.   Rufnummer (intern)

\* This function is only available in the Bundle version.



MT einstell.



Rufmelodie



Melodie 1



Rufmelodie



Melodie 2



Melodie ...



Ruflautst.



Lautstärke 1



Lautstärke 2



Lautstärke ...



Töne



Akkuwarnton



Ein



Reichweite



Aus



Ein



Tastentöne



Aus



Ein



Aus



Sprache



Deutsch



Französisch



Italienisch





































Rücksetzen



Rücksetzen?



Basis einstell.		PIN ändern		 PIN eingeb.		 Neue PIN	
						 PIN wiederh.	
							
		Wahlverf.		DTMF			
							
				Impuls			
		Flash-Zeit		80, 100, 120,			
				180, 250, 300,			
				600 oder 800 ms			
		Amtskennzahl		 Amtskennzahl			
		Rücksetzen		 PIN eingeb.		Rücksetzen?	
Datum / Zeit		 Jahr		 Datum		 Zeit	

## 8.2 Phone book

	Eintrag 1		Neu			Rufnummer		Name	
	Eintrag 2								
	Eintrag ...		Auswählen						
			Ändern			Rufnummer		Name	
			Löschen		Löschen?				

## 8.3 VIP phone book<sup>1</sup>

	Leer		Auswählen						
	Leer								
	...		Ändern			Rufnummer		Name	
			Löschen		Löschen?				

<sup>1</sup> New entries are defined in the VIP phone book using the “Ändern” submenu.

## **9 Explanations**

### **9.1 R button on private branch exchanges**

If the telephone is connected to a private branch exchange, all the functions associated with the R button (7.) such as transferring calls, automatic call back, etc., can be used. A flash time of 100 ms is required for private branch exchanges. The dealer where you purchased the exchange can provide information as to whether the telephone will work properly with the exchange.

### **9.2 R button and supplementary services**

Your telephone supports the most important supplementary services offered by your telephone network provider (e.g. brokering, call waiting, three-way conferencing, etc.). The R button (7.) can be used when implementing the supplementary services. Please contact your telephone network provider regarding which recall (Flash) time must be set to use the supplementary services.

### **9.3 Call number display (CLIP)**

The caller number display function is an optional service offered by telephone network providers. Contact your network provider for further information.

If this function is available with your telephone line, the number of the caller appears in the display when the phone rings. If the caller has suppressed transmission of his phone number, the corresponding message appears in the display.

### **9.4 Call intern**

This function is only available in the Bundle version.

### **9.5 Handset settings**

#### **9.5.1 Ringing melody**

There are 6 different ringing melodies available for selection on the handset.

#### **9.5.2 Ringing volume**

The ringing volume can be set to one of five different volume levels.

#### **9.5.3 Battery low**

When the battery charge is very low, the handset issues acoustic warning signals.

#### **9.5.4 No coverage**

If you move the handset too far from the base station, the handset issues acoustic warning signals.

#### **9.5.5 Key beeps**

An acoustic signal is issued each time a button on the handset is pressed.

#### **9.5.6 Set back handset**

This function resets the handset to its default factory settings.

### **9.6 Base station settings**

#### **9.6.1 PIN code**

The PIN code can contain up to four digits. The default setting of the PIN code is "0000". If you change a PIN code, keep a note of the new PIN code in a safe place. If you forget or lose the PIN code, please contact your sales outlet.

#### **9.6.2 Tone (DTMF) or Pulse dialling mode**

The telephone can be operated in a new, digital exchanges (TONE/DTMF) as well as analogue exchanges (PULSE).

#### **9.6.3 Flash time**

The R button (7.) can be assigned one of 8 different Flash times in order to be able to use functions in private branch exchanges or supplementary services offered by your telephone network provider.

#### **9.6.4 Access code**

In the case of private branch exchanges, it is necessary to dial a specific number in order to obtain the dialling tone for an outside line. This access code can be stored. When the telephone detects this access code preceding a phone number entered, a dialling pause is automatically inserted after the access code.

#### **9.6.5 Set back BS**

This function resets the base station to its default factory settings. The PIN code must be entered in order to use the function.

## **9.7 Phone book**

Up to 20 phone numbers can be stored, with associated names, in the phone book. A further 10 entries can be made in the VIP phone book. Entries in the phone book can only be accessed from the handset in which they were made. The entries in the VIP phone book can be accessed by all the registered handsets.

### **9.7.1 Entering names**

The digit keys are also labelled with letters for the entry of the respective letters. Letters, digits and special characters are entered by pressing the relevant key the respective number of times.

To enter a space, press 1 once.

To enter special characters, press on the 0 button, 1 button or # button as often as necessary until the special character required appears.

To switch between input of upper and lower case letters, press the Star button.

To enter the same letter twice, press the button to enter the letter. Wait until the cursor moves on. Enter the letter again.

If an incorrect character is entered, delete the last entry by pressing the C button (12.).

### **9.7.2 Creating phone book entries**

Always enter the area access code with the phone numbers so that the telephone can also assign incoming local calls to a phone book entry. If the memory capacity of phone book is reached, a corresponding message appears when an attempt is made to store another number. To create space, an entry in the phone book must be deleted.

### **9.7.3 Dialling phone numbers from the phone book**

After opening the phone book, entries can be accessed directly, alphabetically. To do this, press the button with the corresponding first letter of the phone book entry.

Select a phone book entry from the phone book or VIP phone book and dial the number by pressing the Call button (9.).

## - Explanations -

### 9.8 Default settings

<b>Handset</b>		<b>Base station</b>	
Ringing volume:	5	PIN code:	0000
Ringing melody:	1	Calls log:	Empty
Battery warning signal:	On	Dialling method:	TONE
Range warning signal:	On	Flash time:	100 ms
Key tone:	On	PABX:	Empty
Receiver volume:	3		
Loudspeaker volume:	3		
Key lock:	Off		
Redialling list:	Empty		
Phone book:	Empty		

## **10 Troubleshooting**

Should problems arise with the telephone, please refer to the following information first. In the case of claims under the terms of guarantee, contact your sales outlet.

<b>Faults</b>	<b>Corrective measures</b>
No telephone calls possible	<ul style="list-style-type: none"><li>- The telephone line is not connected properly or is defective. Only use the telephone connection cable supplied.</li><li>- Test whether the telephone connection is in order by using another telephone.</li><li>- The power adaptor plug is not plugged in or there is a complete power failure.</li><li>- The rechargeable batteries are empty or defective.</li><li>- The handset is too far from the base station.</li></ul>
Connection is disturbed or cut off	<ul style="list-style-type: none"><li>- The handset is too far from the base station.</li><li>- The base station is in an unsuitable location.</li></ul>
Dialling not possible	<ul style="list-style-type: none"><li>- Dialling mode is set incorrectly.</li></ul>
The system no longer responds or is in an undefined state	<ul style="list-style-type: none"><li>- Reset all the functions to their default settings.</li><li>- Disconnect the power adaptor plug briefly from the power socket.</li></ul>
The handset switches off automatically	<ul style="list-style-type: none"><li>- Place the handset in the base station for 14 hours. Replace the rechargeable batteries.</li></ul>



## - Troubleshooting -

<b>Faults</b>	<b>Corrective measures</b>
Following a charge time of 14 hours, the  icon remains unchanged in the display	<ul style="list-style-type: none"><li>- The rechargeable batteries are empty or defective.</li><li>- Place the handset in the base station properly. Clean the contact surfaces on the handset and base station with a soft, dry cloth.</li></ul>
Display is dark	<ul style="list-style-type: none"><li>- Caused by exposure to direct sunlight. Allow the handset to cool down.</li></ul>
The caller number display (CLIP) does not function	<ul style="list-style-type: none"><li>- The caller number display function is an optional service offered by telephone network providers. Contact your network provider for further information.</li><li>- The caller has suppressed the transmission of their phone number.</li></ul>

## - Important Information -

### 11 Important Information

#### 11.1 Technical data

Feature	Value
Standard	DECT
Power supply	Input: 220/230 V, 50 Hz Output: 6 V, 300 mA
Range (outdoors/indoors)	300 m, 50 m
Standby	Up to 100 h
Max. talk time	Up to 10 h
Rechargeable batteries	2 x 1.2 V/600 mAh, size: AAA
Dialling method	Tone or Pulse dialling mode
Permissible ambient temperature	10°C to 30°C
Permissible relative humidity	20% to 75%
Flash function	80, 100, 120, 180, 250, 300, 600 or 800 ms

GB

DECT: **D**igital **E**uropean **C**ordless **T**elephone = Standard for cordless telephones.

## **12 Index**

### **A**

Access code, 92, 95

### **B**

Base station reset, 92  
Base station settings, 92, 95  
Battery charge status, 83  
Battery low, 91, 94

### **C**

Call intern, 90  
Call number display, 94  
Calls log, 90  
Chain dialling, 86  
Change PIN , 92  
Charging the batteries, 83  
Connecting the base station, 82  
Creating a phone book entry, 89, 93  
Creating phone book entries, 96

### **D**

Date, 92  
Default settings, 97  
Dial mode, 95  
Dial phone number from the calls log, 90  
Dialling pause, 95  
Dialling phone numbers from the phone book, 96  
Display, 84, 85

### **E**

Entering names, 96  
Explanations, 85

### **F**

Flash time, 92, 95

### **H**

Handset settings, 91, 94  
Handsfree, 87

### **I**

Inserting the batteries, 82  
Internal calls, 94

### **K**

Key beeps, 91, 95  
Key lock, 87

### **L**

Language, 91

### **M**

Muting the microphone, 87

### **N**

Navigation, 89  
No coverage, 91, 95

### **O**

Operating elements, 81

### **P**

Package contents, 82  
Paging, 88  
Phone book, 93, 96  
PIN code, 95  
Pulse-Tone dialling, 92  
Pulse/Tone dialling mode, 95

## **R**

- R button, 95
- R button and supplementary services, 94
- R button on private branch exchanges, 94
- Receiver volume, 87
- Redial, 90
- Redialling, 86
- Reset handset, 91
- Resetting the base station, 95
- Ring melody, 91
- Ring volume, 91
- Ringing melody, 88, 94
- Ringing volume, 94

## **S**

- Safety information , 79

- Selecting numbers from the phone book, 93
- Service phone book, 93, 96
- Set back handset, 95
- Storing numbers from calls log in the phone book, 90

## **T**

- Taking a call, 85
- Talk time, 88
- Technical data, 100
- Telephoning, 85
- Temporary tone dialling, 87
- Time, 92
- Tone dialling mode, 92
- Tone/Pulse dialling mode, 95
- Troubleshooting , 98



