

# **SWITEL**

**COMMUNICATION PRODUCTS**

**Schnurlostelefon**  
**Téléphone sans fil**  
**Telefono senza fili**  
**Cordless telephone**

# **CD77382**



**Bedienungsanleitung**  
**Mode d'emploi**  
**Istruzioni per l'uso**  
**Operating Instructions**

**D**

**F**

**I**

**GB**

# ***SWITEL***

Bedienungsanleitung . . . . .	3
Mode d'emploi . . . . .	25
Istruzioni per l'uso . . . . .	48
Operating Instructions . . . . .	71
Declaration of Conformity . . . . .	95

1	Sicherheitshinweise . . . . .	4
2	Telefon in Betrieb nehmen . . . . .	5
3	Bedienelemente . . . . .	6
4	Wie bediene ich mein Telefon? . . . . .	7
5	Telefonieren . . . . .	9
6	Anrufbeantworter . . . . .	11
7	Nebenstellenanlagen/ Zusatzdienste . . . . .	14
8	Menüstruktur . . . . .	15
9	SMS . . . . .	18
10	Mehrere Mobilteile / Basisstationen . . . . .	19
11	Falls es Probleme gibt . . . . .	20
12	Technische Eigenschaften . . . . .	21
13	Pflegehinweise / Garantie . . . . .	23
14	Index . . . . .	24

# Sicherheitshinweise

## 1 Sicherheitshinweise

Lesen Sie diese Bedienungsanleitung sorgfältig durch.

### Bestimmungsgemäße Verwendung

Dieses Telefon ist geeignet für das Telefonieren innerhalb eines Telefonnetzes. Jede andere Verwendung gilt als nicht bestimmungsgemäß. Eigenmächtige Veränderungen oder Umbauten sind nicht zulässig. Öffnen Sie das Gerät in keinem Fall selbst und führen Sie keine eigenen Reparaturversuche durch.

### Aufstellungsort

Vermeiden Sie Belastungen durch Rauch, Staub, Erschütterungen, Chemikalien, Feuchtigkeit, Hitze oder direkte Sonneneinstrahlung.

Verwenden Sie das Mobilteil nicht in explosionsgefährdeten Bereichen.

### Netzteil



**Achtung:** Verwenden Sie nur das mitgelieferte Steckernetzteil, da andere Netzteile das Telefon beschädigen können. Sie dürfen den Zugang zum Steckernetzteil nicht durch Möbel oder andere Gegenstände versperren.

### Aufladbare Akkus



**Achtung:** Werfen Sie Akkus nicht ins Feuer und tauchen Sie sie nicht ins Wasser.

### Stromausfall

Bei Stromausfall kann mit dem Telefon nicht telefoniert werden. Halten Sie für Notfälle ein schnurgebundenes Telefon bereit, welches ohne eine externe Stromversorgung arbeitet.

### Medizinische Geräte



**Achtung:** Benutzen Sie das Telefon nicht in der Nähe von medizinischen Geräten. Eine Beeinflussung kann nicht völlig ausgeschlossen werden.

DECT<sup>1</sup>-Telefone können in Hörgeräten einen unangenehmen Brummtönen verursachen.

### Entsorgung

Sie sind gesetzlich zur sachgerechten Entsorgung von Gebrauchsgütern verpflichtet. Das nebenstehende Symbol auf Ihrem Telefon bedeutet, dass elektrische und elektronische Altgeräte und Akkus getrennt vom Hausmüll zu entsorgen sind.

**Elektrische oder elektronische Geräte** entsorgen Sie bei einer Sammelstelle eines geeigneten Entsorgungsträgers.

**Akkus** entsorgen Sie beim batterievertreibenden Handel sowie bei zuständigen Sammelstellen, die entsprechende Behälter bereitstellen.

**Verpackungsmaterialien** entsorgen Sie entsprechend den lokalen Vorschriften.



<sup>1</sup> DECT: Digitally Enhanced Cordless Telephone = Standard für kabellose Telefone.

## 2 Telefon in Betrieb nehmen

### Sicherheitshinweise



**Achtung:** Lesen Sie vor der Inbetriebnahme unbedingt die Sicherheitshinweise in Kapitel 1.

### Verpackungsinhalt prüfen

Zum Lieferumfang gehören:

- eine Basisstation mit Netzteil
- zwei Mobilteile
- eine Ladestation mit Netzteil
- ein Telefonanschlusskabel
- vier Akkus
- eine Bedienungsanleitung

### Basisstation anschließen



**Achtung:** Stellen Sie die Basisstation mit einem Mindestabstand von 1 m zu anderen elektronischen Geräten auf, da es sonst zu gegenseitigen Störungen kommen kann.

Schließen Sie die Basisstation wie auf der Skizze abgebildet an. Verwenden Sie aus Sicherheitsgründen nur das mitgelieferte Netzteil sowie das beigelegte Telefonanschlusskabel.

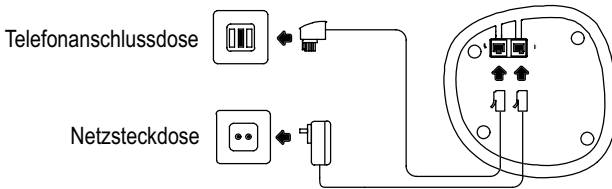

### Ladestation anschließen

Schließen Sie die Ladestation wie auf der Skizze abgebildet an. Verwenden Sie aus Sicherheitsgründen nur das mitgelieferte Netzteil.

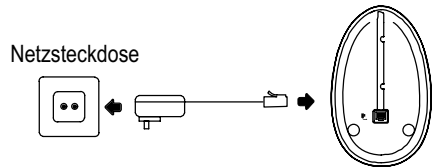

### Akkus einlegen

Legen Sie die Akkus in das geöffnete Batteriefach ein. Verwenden Sie nur Akkus des Typs AAA Ni-MH 1,2 V. Achten Sie auf die richtige Polung! Schließen Sie das Batteriefach.

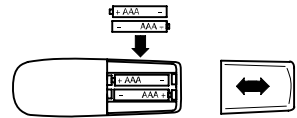

### Akkus aufladen

Stellen Sie das Mobilteil bei der ersten Inbetriebnahme für mindestens 14 Stunden in die Basisstation / Ladestation. Haben Sie das Mobilteil richtig in die Basisstation / Ladestation gestellt, leuchtet die Ladekontrollleuchte. Das Mobilteil erwärmt sich beim Laden. Dies ist normal und ungefährlich. Laden Sie das Mobilteil nicht mit fremden Aufladegeräten. Der aktuelle **Akkuladezustand** wird im Display angezeigt:



Voll



Halb



Schwach



Leer

### Mobilteil aus- und einschalten

Um die Standard-Akkus zu schonen, können Sie das Mobilteil aus- und einschalten.

2 sec

Mobilteil ausschalten

Mobilteil einschalten

### Datum und Uhrzeit einstellen

Auf Seite 16 erfahren Sie, wie Sie bei der ersten Inbetriebnahme das Datum und die Uhrzeit Ihres Mobilteils einstellen können.

### Nebenstellenanlagen

Auf Seite 14 finden Sie weitere Informationen, wenn Sie Ihr Telefon an einer Nebenstellenanlage anschließen möchten.

# Bedienelemente

## 3 Bedienelemente

### Mobilteil

- 1 Aufwärts blättern / Wahlwiederholungsliste
- 2 Softkeytaste rechts
- 3 Gespräch beenden / Mobilteil ein-, ausschalten
- 4 Tastensperre / Konferenzgespräche
- 5 Interngespräche
- 6 R-Taste
- 7 Abwärts blättern / entgangene Anrufe
- 8 Gespräch annehmen / Freisprechen
- 9 Softkeytaste links

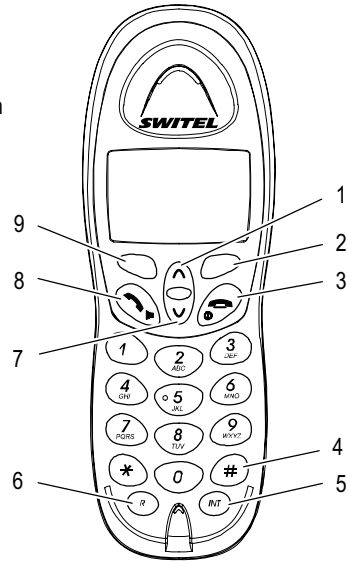

### Basisstation (Anrufbeantworter)

- 1 Paging-Taste (Mobilteil suchen)
- 2 Lautstärke -
- 3 Anrufbeantworter Ein / Aus
- 4 Lautstärke +
- 5 Vorige Nachricht / Memo aufzeichnen
- 6 Stopp
- 7 Ansage anhören / aufzeichnen
- 8 LED Netzanzeige
- 9 Nächste Nachricht / Verzögerung der Anrufannahme
- 10 Löschen / Sicherheitscode
- 11 LED Ladekontrollleuchte
- 12 Wiedergabe

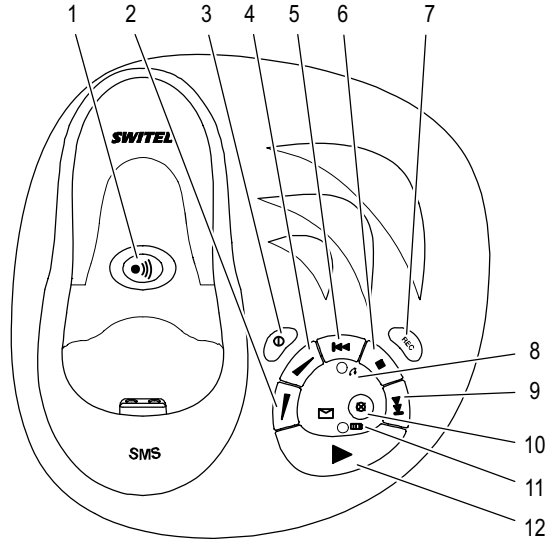

### Ladestation

- 1 LED Ladekontrollleuchte

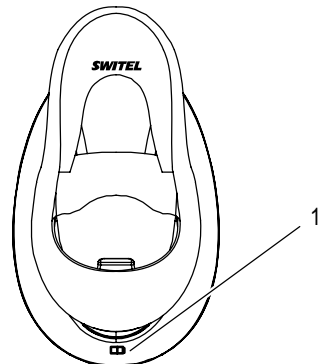

Die Tasten werden in dieser Bedienungsanleitung mit einer einheitlichen Kontur abgebildet. Abweichungen von Tastensymbolen Ihres Telefons gegenüber den hier abgebildeten Tastensymbolen sind möglich.

## 4 Wie bediene ich mein Telefon?

### Darstellungen und Schreibweisen

	Nummern oder Buchstaben eingeben
	Abgebildete Taste kurz drücken
2 sec	Abgebildete Taste 2 Sekunden drücken
halten	Abgebildete Taste halten
loslassen	Abgebildete Taste loslassen
	Mobilteil klingelt
	Basisstation klingelt
	Mobilteil aus der Basisstation nehmen
	Mobilteil in die Basisstation stellen
Nr. einfügen	Text und Symbole im Display
Optionen	Softkeytaste drücken  Seite 8 Navigationstasten

### Symbole im Display

Symbol	Beschreibung
	Konstant: Anzeige der Batteriekapazität. Blinkend: Laden Sie die Akkus. Durchlaufende Segmente: Die Akkus werden geladen.  Seite 5
	Das Freisprechen ist aktiviert.  Seite 10
	Die Tastensperre ist aktiviert.  Seite 10
	Der "Wecker" ist eingeschaltet.  Seite 16
	Es sind neue Anrufe in der Anrufliste (CLIP) gespeichert.  Seite 14
	Sie haben eine neue <b>SMS</b> <sup>1</sup> .  Seite 18
	Anrufbeantworter im Telefonnetz. <b>VMWI</b> <sup>2</sup> - Optionaler Service Ihres Netzbetreibers  Seite 14
	Konstant: Die Verbindung zur Basisstation ist gut. Blinkend: Die Verbindung zur Basisstation ist nicht gut. Nähern Sie sich der Basisstation.
1	Interne Rufnummer des Mobilteils  Seite 19
20:22	Anzeige der Uhrzeit  Seite 16
SWITEL	Anzeige des Mobilteil-Namens  Seite 16

<sup>1</sup> **SMS**: Short Message Service

<sup>2</sup> **VMWI**: Visual Message Waiting Indication



# Wie bediene ich mein Telefon?

## Navigationstasten

Alle Beschreibungen in dieser Bedienungsanleitung gehen davon aus, dass sich das Mobilteil im Standby-Modus befindet. Den Standby-Modus erreichen Sie durch Drücken der Taste .

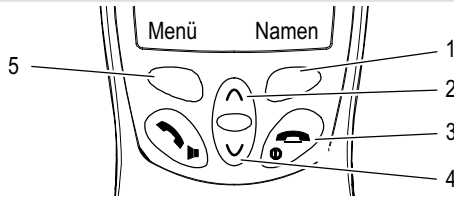







 Die Softkeystasten (1) und (5) sind in den verschiedenen Menüs mit unterschiedlichen Funktionen belegt. Sie sind in dieser Bedienungsanleitung immer nach den darüber liegenden Texten im Display benannt.



Taste	Im Standby-Modus	Im Menü
1	- öffnet das Telefonbuch	- eine Ebene zurück
2 	- öffnet die Wahlwiederholungsliste	- in den Menüs blättern - ändern von Einstellungen
3 	- Mobilteil ein-, ausschalten	- Programmier- und Speichervorgänge abbrechen
4 	- öffnet die Liste der entgangenen Anrufe	- in den Menüs blättern - ändern von Einstellungen
5	- öffnet Hauptmenü	- öffnet angezeigtes Menü

## Navigation im Menü







Alle Funktionen sind über unterschiedliche Menüs zu erreichen. Den Weg zur gewünschten Funktion entnehmen Sie der Menüstruktur.  Seite 15

Menü	Hauptmenü öffnen
 oder 	Gewünschtes Untermenü auswählen
OK	Untermenü öffnen
 oder 	Gewünschte Funktion auswählen
OK	Funktion öffnen
 oder 	Gewünschte Einstellung auswählen
	Über Tastenfeld Nummern oder Buchstaben eingeben
OK	Eingaben bestätigen
Zurück	eine Ebene zurück
	Programmier- und Speichervorgänge abbrechen und in den Standby-Modus zurückkehren

 Jeder Vorgang wird automatisch abgebrochen, wenn innerhalb von 60 Sekunden keine Eingabe erfolgt.

## Beispiel

Wie Sie in den Menüs navigieren und Eingaben vornehmen ist hier anhand des Beispiels "Telefonbucheinträge erstellen" erklärt. Verfahren Sie bei allen Einstellungen wie bei diesem Beispiel.

Namen	Telefonbuch öffnen
Optionen  oder 	
Nr. einfügen 	Funktion auswählen und bestätigen
 	Namen eingeben und bestätigen
 	Rufnummer eingeben und bestätigen



## 5 Telefonieren

### Anruf annehmen

 ,  oder  Anruf annehmen

### Gespräch beenden

 oder  Gespräch beenden

### Anrufen

 Rufnummer eingeben (max. 25 Ziffern)

 Löschen Bei Falscheingabe letzte Ziffer löschen

 Rufnummer wählen

 Sie können auch zuerst die Gesprächstaste drücken und erhalten damit das Freizeichen. Die eingegebenen Ziffern Ihrer gewünschten Rufnummer werden sofort gewählt. Eine Korrektur einzelner Ziffern der Rufnummer ist bei dieser Form des Gesprächsaufbaus nicht möglich.

### Wahlwiederholung

Ihr Telefon speichert die 20 zuletzt gewählten Rufnummern in einer Wahlwiederholungsliste.

 Wahlwiederholungsliste öffnen

 oder ,  Eintrag auswählen und Verbindung herstellen

### Eingegangene Anrufe zurückrufen

Ihr Telefon speichert 20 eingegangene Anrufe in einer Anrufliste.

 Anrufliste öffnen

 oder ,  Eintrag auswählen und Verbindung herstellen

### Rufnummern aus dem Telefonbuch wählen

Sie müssen Rufnummern im Telefonbuch gespeichert haben.  Seite 8 und 17

 Namen Telefonbuch öffnen

 oder ,  Eintrag auswählen und Verbindung herstellen

### Intern telefonieren

#### Interne Gespräche führen



Sie müssen zwei oder mehr Mobilteile (MT1, MT2, ...) an einer Basisstation angemeldet haben, um interne, kostenlose Gespräche führen zu können.

MT1: , z. B.   Interne Rufnummer des gewünschten Mobilteils wählen

MT2:  Internes Gespräch am anderen Mobilteil annehmen



MT1 / MT2:  Internes Gespräch beenden

#### Externe Gespräche intern weiterleiten

MT1: , z. B.   Während des externen Gesprächs interne Rufnummer wählen



MT2:  Internes Gespräch am anderen Mobilteil annehmen

MT1:  Gespräch weiterleiten

 Sollte sich das gerufene Mobilteil nicht melden, können Sie sich das externe Gespräch durch Drücken der Taste  wieder zurückholen.

#### Rücksprache / Makeln

Während eines externen Gesprächs können Sie ein anderes Mobilteil anwählen, um Rücksprache zu halten. Der externe Gesprächspartner wird gehalten, während Sie mit dem internen Gesprächspartner sprechen. Sie können den Gesprächspartner beliebig oft wechseln.

MT1: , z. B.   Während des externen Gesprächs interne Rufnummer wählen

MT2:  Internes Gespräch am anderen Mobilteil annehmen

MT1 :  Gesprächspartner wechseln

# Telefonieren

## Konferenzgespräche führen

Ein externes Gespräch kann mit einem weiteren internen Gesprächspartner zum Konferenzgespräch geschaltet werden.

MT1: <b>INT</b> , z. B. <b>2</b>	Während des externen Gesprächs interne Rufnummer wählen
MT2:	Internes Gespräch am anderen Mobilteil annehmen
MT1: 2 sec <b>#</b>	Konferenz starten
MT1 / MT2:	Durch Auflegen eines internen Gesprächspartners wird die Konferenz beendet

## Einstellen der Hörerlautstärke

Sie können während eines Gesprächs die Lautstärke in 5 Stufen anpassen.

oder	Während des Gesprächs drücken
------	-------------------------------

## Anzeige der Gesprächsdauer

Während eines Gesprächs wird die Gesprächsdauer in Minuten und Sekunden angezeigt.

## Freisprechen

Nutzen Sie diese Funktion, um den Gesprächspartner über den Lautsprecher zu hören.

	Freisprechen einschalten
	Freisprechen ausschalten

## Mikrofon im Mobilteil stummschalten

Sie können während eines Telefongesprächs das Mikrofon des Mobilteils aus- und einschalten.

<b>Stumm</b> <b>Stumm ein</b>	Mikrofon ausschalten (stummschalten)
<b>Stumm</b>	Mikrofon einschalten

## Tastensperre

Bei eingeschalteter Tastensperre können eingehende Anrufe wie gewohnt angenommen werden.

2 sec <b>#</b>	Tastensperre einschalten
<b>ENTSPERR</b> , <b>Ja</b>	Tastensperre ausschalten

## Mobilteil suchen (Paging)

Wenn Sie Ihr Mobilteil verlegt haben, können Sie es über einen Suchton leicht wiederfinden.

	Suchton starten
oder	Suchton beenden

## 6 Anrufbeantworter



Ihr Anrufbeantworter verfügt über eine gesprochene Bedienerführung. Beachten Sie diese Anweisungen und Hinweise.

### Spracheinstellung

Die Sprachausgabe des Anrufbeantworters ist in Englisch vorhanden und nicht veränderbar.

### Wochentag und Uhrzeit einstellen

Beim Abspielen der Nachrichten wird zu jeder Nachricht der Wochentag und die Uhrzeit ihres Eingangs angesagt.

2 sec	Einstellungsmodus aktivieren
oder ,	Wochentag einstellen und bestätigen
oder ,	Stunden einstellen und bestätigen
oder ,	Minuten einstellen und bestätigen

### Wochentag und Uhrzeit abhören

	Eingestellten Wochentag und Uhrzeit abhören
--	---

### Anrufbeantworter ein- / ausschalten

	Anrufbeantworter ein- / ausschalten
--	-------------------------------------

### Maximale Aufnahmezeit

Der Anrufbeantworter speichert bis zu 60 Nachrichten. Die maximale Aufnahmezeit beträgt 16 Minuten. Die maximale Länge jeder Nachricht beträgt 2 Minuten. Ist die Speicherkapazität für neue Nachrichten erschöpft, wird kein Anruf mehr aufgezeichnet.

### Lautstärke einstellen

Sie können die Lautstärke in 11 Stufen einstellen.

oder	Lautstärke einstellen
------	-----------------------

### Verzögerung der Anrufannahme

Sie können zwischen 2 und 9 Tonrufen und der Einstellung **Gebührensparer** für die gebührenfreie Vor-Fernabfrage wählen. Mit der gebührenfreien Vor-Fernabfrage können Sie feststellen, ob sich neue Nachrichten auf Ihrem Anrufbeantworter befinden.

- Befinden sich neue Nachrichten auf Ihrem Anrufbeantworter, wird Ihr Anruf bereits nach 2 Tonrufen angenommen.
- Wurden keine Nachrichten aufgezeichnet, wird Ihr Anruf erst nach 4 Tonrufen angenommen. Legen Sie vor dem 4. Tonruf auf. So fallen keine Gebühren an.

halten	Einstellungsmodus aktivieren
loslassen	Einstellung auswählen

Weitere Informationen über die Fernabfrage Seite 12

### Anruf übernehmen

Wenn der Anrufbeantworter bereits einen Anruf entgegengenommen hat, können Sie diesen übernehmen. Die Aufzeichnung der Nachricht wird in diesem Fall abgebrochen.

oder	Anruf übernehmen
------	------------------

### Ansagemodus wählen

Ihr Anrufbeantworter stellt Ihnen zwei voreingestellte Ansagetexte zur Verfügung. Nach dem Ansagetext 1 kann eine Nachricht hinterlassen werden. Bei Ansagetext 2 handelt es sich um eine Nur-Ansage, nach der keine Nachricht hinterlassen werden kann. Sie können Ansagetext 1 und Ansagetext 2 durch einen eigenen Ansagetext ersetzen. Ist der Speicher des Anrufbeantworters voll, wird automatisch Ansagetext 2 wiedergegeben.





2 sec	Einstellungsmodus aktivieren
	Ansagetext 1 aktivieren
	Ansagetext 2 aktivieren

# Anrufbeantworter

## Ansagen aufzeichnen / kontrollieren oder löschen

### Ansagen aufzeichnen

Die Länge der eigenen Ansage darf bis zu 40 Sekunden betragen.



2 sec 	Einstellungsmodus aktivieren
halten 	Aufzeichnung starten (Ansagetext 1)
loslassen 	Aufzeichnung beenden (Ansagetext 1)
halten 	Aufzeichnung starten (Ansagetext 2)
loslassen 	Aufzeichnung beenden (Ansagetext 2)

### Kontrollieren der aktuell eingestellten Ansage

	Ansage anhören
---	----------------

### Eigene Ansage löschen und zur Standardansage zurückkehren

Wenn Sie Ihre eigene Ansage löschen, wird die voreingestellte Standardansage wieder aktiviert.

	Ansage anhören
	Ansage löschen

## Memo aufzeichnen

Ein Memo ist eine Mitteilung, die wie eine eingegangene Nachricht abgehört werden kann.

### Memo aufzeichnen





Die Länge des Memos darf bis zu 2 Minuten betragen.

halten 	Aufzeichnung starten
loslassen 	Aufzeichnung beenden



## Aufgezeichnete Nachrichten / Memos abhören / löschen

### Nachrichten / Memos abhören

Die aufgezeichneten Nachrichten / Memos werden in der Reihenfolge wiedergegeben, in der sie aufgezeichnet wurden. Der Wochentag und die Uhrzeit werden vor dem Abspielen der jeweiligen Nachricht oder des jeweiligen Memos genannt.



2 sec 	neue Nachrichten / Memos abhören
	alle Nachrichten / Memos abhören
	Wiedergabe stoppen
	Nachricht wiederholen
	nächste Nachricht

### Eine Nachricht / Memo löschen

	Zu löschende Nachricht / Memo abhören
	Nachricht / Memo löschen

## Alle Nachrichten / Memos löschen

Es werden alle Nachrichten / Memos gelöscht. Neue Nachrichten / Memos werden ebenfalls gelöscht. Hören Sie alle Nachrichten / Memos ab. Nachdem Sie alle Nachrichten / Memos abgehört haben, können Sie alle Nachrichten / Memos löschen.











	alle Nachrichten / Memos abhören
	Nachrichten / Memos löschen

## Die Fernabfrage





Sie können Ihren Anrufbeantworter anrufen, um Nachrichten abzuhören und weitere Funktionen durchzuführen. Voraussetzung dafür ist ein Telefon mit Tonwahlfunktion.

### Der Sicherheitscode für die Fernabfrage

Um die Fernabfrage durchzuführen, müssen Sie einen Sicherheitscode eingeben. Dieser ist werkseitig auf "000" eingestellt.



2 sec 	Einstellungsmodus aktivieren
 oder  , 	1. Nummer ändern und bestätigen
 oder  , 	2. Nummer ändern und bestätigen
 oder  , 	3. Nummer ändern und bestätigen

## Fernabfrage starten

-  Eigene Rufnummer wählen
  -  ,  Während der Ansage betätigen und Sicherheitscode eingeben
-  Bei falscher Eingabe hören Sie erneut die Ansage des Anrufbeantworters. Wurde der Sicherheitscode dreimal falsch eingegeben, wird die Leitung automatisch getrennt.

Jetzt haben Sie die Möglichkeit weitere Funktionen durchzuführen. ➔ Tabelle Tastenfunktionen

## Ferneinschalten des Anrufbeantworters

-  Eigene Rufnummer wählen
-  Haben Sie vergessen Ihren Anrufbeantworter einzuschalten, wird Ihr Anruf erst nach 20 Tonrufen angenommen.

-  ,  Nach Signalton betätigen und Sicherheitscode eingeben

-  Anrufbeantworter ein- / ausschalten

Jetzt haben Sie die Möglichkeit weitere Funktionen durchzuführen. ➔ Tabelle Tastenfunktionen

## Tastenfunktionen der Fernabfrage

-  Die Fernabfrage wird automatisch abgebrochen, wenn innerhalb von 10 Sekunden keine Eingabe erfolgt.

Die Tastenfunktionen sind abhängig davon, in welchem Menü Sie sich befinden. Die folgende Tabelle verschafft Ihnen eine Übersicht über die jeweiligen Funktionen der einzelnen Tasten.

Taste	1 Funktionen im Hauptmenü	8 Funktionen im Ansagenmenü
1	Hauptmenü erneut anhören	Hauptmenü öffnen und anhören
2	alle Nachrichten abhören	eingestellten Ansagetext anhören
3	nur neue Nachrichten abhören	Ansagetext 1 aufzeichnen ➔ Seite 12
4	laufende Nachricht erneut abhören	Ansagetext 2 aufzeichnen ➔ Seite 12
5	- laufende Nachricht löschen - alle Nachrichten löschen (nachdem alle Nachrichten / Memos abgehört wurden)	- Ansagetext 1 aktivieren ➔ Seite 12 - Ansagetext 1 oder 2 löschen (Ansagetext anhören und während der Wiedergabe löschen)
6	nächste Nachricht abhören	Ansagetext 2 aktivieren ➔ Seite 12
7	Anrufbeantworter ein- / ausschalten	
8	Ansagenmenü öffnen und anhören	Ansagenmenü erneut anhören
9	Sicherheitscode einstellen Einstellungsmodus aktivieren: * Sicherheitscode einstellen: z. B. "000" = 0, 0, 0 Einstellung bestätigen: #	
0	Wochentag und Uhrzeit einstellen Einstellungsmodus aktivieren: * Wochentag einstellen: Montag = 1, Dienstag = 2, Mittwoch = 3, Donnerstag = 4, Freitag = 5, Samstag = 6, Sonntag = 7 Uhrzeit einstellen: z. B. 10:15 Uhr = 1, 0, 1, 5 Einstellung bestätigen: #	
*	Einstellungsmodus aktivieren	
#	Einstellung bestätigen	Aufzeichnung beenden
	Das Auflegen beendet die Fernabfrage.	

# Nebenstellenanlagen / Zusatzdienste

## 7 Nebenstellenanlagen / Zusatzdienste

### R-Taste an Nebenstellenanlagen

Ist Ihr Telefon an einer Nebenstellenanlage angeschlossen, können Sie über die **R-Taste** Funktionen, wie z. B. Anrufe weiterleiten und automatischen Rückruf, nutzen. Lesen Sie bitte in der Bedienungsanleitung Ihrer Nebenstellenanlage, welche Flash-Zeit Sie zur Nutzung dieser Funktionen einstellen müssen. Ob Ihr Telefon an Ihrer Nebenstellenanlage einwandfrei funktioniert, erfahren Sie bei dem Händler, bei dem die Anlage gekauft wurde. Einstellen der Flash-Zeit  Seite 16

### Zugangskode (Amtskennziffer)

Bei Nebenstellenanlagen ist es erforderlich, eine Amtskennzahl vorzuwählen, um ein Freizeichen zu bekommen. Haben Sie in Ihrem Mobilteil eine Amtskennziffer gespeichert und aktiviert, wird diese Amtskennziffer automatisch vor den Rufnummern aus dem Telefonbuch und denen aus Anruflisten vorgewählt.

### Wahlpause

Bei Nebenstellenanlagen ist es erforderlich, eine Amtskennzahl vorzuwählen, um ein Freizeichen zu bekommen. Bei wenigen, älteren Nebenstellenanlagen dauert es einige Zeit, bis das Freizeichen zu hören ist. Für diese Nebenstellenanlagen kann nach der Amtskennzahl eine Wahlpause eingefügt werden, um direkt weiter wählen zu können, ohne das Freizeichen abzuwarten.

2 sec  Wahlpause einfügen

Nach der Amtskennzahl wartet Ihr Telefon für 3 Sekunden mit dem Wählen der eigentlichen Rufnummer.

 Die Pause kann auch bei der Eingabe von Rufnummern in das Telefonbuch eingegeben werden.

### R-Taste und Zusatzdienste

Ihr Telefon unterstützt Zusatzdienste Ihres Netzbetreibers, wie z. B. Makeln, Anklopfen und Konferenz. Über die **R-Taste** können Sie diese Zusatzdienste nutzen. Bitte fragen Sie Ihren Netzbetreiber, welche Flash-Zeit Sie zur Nutzung von Zusatzdiensten einstellen müssen. Zur Freischaltung von Zusatzdiensten wenden Sie sich bitte an Ihren Netzbetreiber. Einstellen der Flash-Zeit  Seite 16

### Anrufbeantworter im Telefonnetz

Wenn Ihr Netzbetreiber einen Anrufbeantworter im Telefonnetz für Sie bereitstellt, werden Sie mit einem Symbol (**VMWI**<sup>1</sup>) über neue Nachrichten informiert. Der Anrufbeantworter und die Information über neue Nachrichten mit einem Symbol sind optionale Services Ihres Netzbetreibers. Über diese Funktionen können Sie nur dann verfügen, wenn Ihr Netzbetreiber diesen Service anbietet. Bitte fragen Sie Ihren Netzbetreiber nach weiteren Informationen.

### Rufnummernanzeige (CLIP<sup>2</sup>)

Wenn diese Funktion an Ihrer Telefonleitung zur Verfügung steht, wird Ihnen bereits die Rufnummer des Anrufers angezeigt, wenn das Telefon klingelt. Hat der Anrufer das Übertragen seiner Rufnummer unterdrückt, wird eine entsprechende Meldung angezeigt. Die Rufnummer kann nicht angezeigt und somit auch nicht in der Anrufliste gespeichert werden.

 Die Rufnummernanzeige ist ein optionaler Service Ihres Netzbetreibers. Fragen Sie Ihren Netzbetreiber nach weiteren Informationen.

<sup>1</sup> **VMWI**: Visual Message Waiting Indication

<sup>2</sup> **CLIP**: Calling Line Identification Presentation

## 8 Menüstruktur

### Hauptmenü

In das Hauptmenü gelangen Sie durch Drücken der Softkeytaste **Menü**.

SMS <sup>1</sup>	Nachricht schreiben	Optionen	Senden an	Suchen
			Speichern	
			Symbol einfügen	
			Benutzername	Allgemeines Postfach
				Benutzer 1-4
				Passwort
	Eingang	Lesen	Optionen	Antworten
				Weiterleiten
				Löschen
	Ausgang	Lesen	Optionen	Bearbeiten
	Nachricht löschen	Eingang		Senden an
		Ausgang		Löschen
		Alle Nachrichten		Benutzername
	Einstellungen	Service Center	Empfangs-SC	Empfangs-SC
			Sende-SC	Sende-SC
		Apparatnummer	Apparatnummer	
		Nachrichtenton	Ein/Aus	
			Warnton einstellen	Morseton
				Diskret
				Polyphon
		Benutzer	Benutzer löschen	Benutzer 1-4
			Benutzer hinzufügen	Benutzername
			Passwort	Nochmal eingeben

Anruferlisten <sup>2</sup>	Eingegangene Anrufe	Optionen	Löschen
			Details anzeigen
			Nr. einfügen
	Entgangene Anrufe	Optionen	Löschen
			Details anzeigen
			Nr. einfügen
	Gewählte Nummern	Optionen	Löschen
			Details anzeigen
			Nr. einfügen
	Anruferliste löschen	Eingegangene Anrufe	
		Entgangene Anrufe	
		Gewählte Nummern	
		Alle Anrufe	

<sup>1</sup> Weitere Informationen zu SMS-Textnachrichten Seite 18

<sup>2</sup> Für das Anzeigen und Speichern von Rufnummern in Anruflisten wird die Rufnummernanzeige (**CLIP**<sup>3</sup>) benötigt. Die Rufnummernanzeige ist ein optionaler Service Ihres Netzbetreibers. Fragen Sie Ihren Netzbetreiber nach weiteren Informationen. Weitere Informationen über die Rufnummernanzeige Seite 14

<sup>3</sup> **CLIP**: Calling Line Identification Presentation

# Menüstruktur

Mobilteil	Rufton	Externe Anrufe	Melodie 1-5
		Interne Anrufe	Melodie 1-5
	Ruftonlautstärke	Ruftonlautstärke 1-5 / Aus	
	Name Mobilteil	☰ Name	
	Sprache <sup>1</sup>	Sprache 1-7	
	Menüfarbe	Blau	
		Grün	
		Pink	
	Auto. Gesprächsanna <sup>2</sup>	Ein/Aus	
	Zugangskode <sup>3</sup>	Ein/Aus	
		☰ Kode einstellen	

Basis-Einstellungen	Rufton Basis	Melodie 1-5		
	Lautstärke Basis	Lautstärke Basis 1-5 / Aus		
	Vorrang Mobilteil <sup>4</sup>	Alle Mobilteile		
		Mobilteil auswählen	Mobilteil 1-5	Ruftöne 2
				Ruftöne 4
				Ruftöne 6
	Flashzeiten	Flash 1 (100 ms)		
		Flash 2 (300 ms)		
	System-PIN <sup>5</sup>	☰ Alte PIN eingeben	☰ Neue PIN eingeben	▶
				▶ ☰ Neue PIN bestätigen

Zeiteinstellung	Wecker	Ein/Aus	Einmalig	☰ Zeit (24 Std.)
			Täglich	☰ Zeit (24 Std.)
			Aus	
		Weckton einstellen	Weckton 1-4	
	Zeit und Datum einst	☰ Datum	☰ Zeit (24 Std.)	

Anmeldung	Mobilteil anmelden	Basis 1-4	☰ System-PIN <sup>5</sup>
	Basis auswählen	Automatik	
		Basis 1-4	
	Mobilteil abmelden	☰ System-PIN <sup>5</sup>	Mobilteil 1-5

<sup>1</sup> Sprachen: Englisch, Französisch, Deutsch, Italienisch, Spanisch, Niederländisch und Portugisisch.

<sup>2</sup> Haben Sie die Funktion aktiviert, wird ein Anruf automatisch beim Herausnehmen des Mobilteils aus der Basisstation angenommen.

<sup>3</sup> Weitere Informationen über Nebenstellenanlagen ☞ Kapitel 7.





<sup>4</sup> Hier können Sie einstellen, ob bei einem eingehenden Anruf alle angemeldeten Mobilteile klingeln sollen oder ob vorrangig zunächst nur ein bestimmtes Mobilteil klingeln soll.

<sup>5</sup> Werkseinstellung System-PIN: 0000



## Telefonbuch

In das Telefonbuch gelangen Sie durch Drücken der Softkeytaste **Namen** .

Eintrag 1	Optionen	Nr. einfügen	 Name 1	 Nummer:
Eintrag 2		Details anzeigen		
Eintrag ...		Nr. löschen		
		Nr. ändern	 Name 1	 Nummer:
		Rufton <sup>2</sup>	Aus	
			Melodie 1-5	
	Rubrik löschen			

<sup>1</sup> Die Zahlentasten sind mit Buchstaben beschriftet. Durch mehrmaliges Drücken der entsprechenden Taste können Buchstaben, Zahlen und Sonderzeichen eingegeben werden.

<sup>2</sup> Hier können Sie einem Telefonbucheintrag eine bestimmte Tonrufmelodie zuordnen. Ihr Mobilteil meldet sich dann bei eingehenden Anrufen dieses Anrufers mit der eingestellten Tonrufmelodie. Für diese Funktion wird die Rufnummernanzeige (**CLIP**<sup>3</sup>) benötigt. Die Rufnummernanzeige ist ein optionaler Service Ihres Netzbetreibers. Fragen Sie Ihren Netzbetreiber nach weiteren Informationen.

<sup>3</sup> **CLIP**: Calling Line Identification Presentation

## 9 SMS

### SMS Voraussetzungen

Ihr Telefonanschluss muss über das Leistungsmerkmal **CLIP**<sup>1</sup> verfügen. Vergewissern Sie sich bei Ihrem Netzbetreiber, dass dieses Leistungsmerkmal an Ihrem Telefonanschluss freigeschaltet ist. Um den **SMS**<sup>2</sup>-Dienst zu nutzen, muss dieser bei Ihrem Netzbetreiber aktiviert werden.

- Von Nebenstellenanlagen können keine SMS versendet werden.
- Bei Call-by-Call-Verbindungen ist der SMS-Versand derzeit nicht möglich.
- Das Senden von SMS-Nachrichten ist kostenpflichtig.
- Nutzt der Empfänger im Festnetz keinen SMS-Dienst oder kann sein Telefon generell keine SMS empfangen, wird die SMS automatisch als Sprachmeldung zugestellt.
- Die Kostenberechnung erfolgt über Ihren Netzbetreiber.

### SMS Service Center

Die Verteilung von SMS-Nachrichten erfolgt über ein Service Center. Wenn Sie SMS-Textnachrichten versenden möchten, müssen Sie eine Service Center Nummer in Ihrem Mobilteil einprogrammieren ☞ Seite 15. Bitte erfragen Sie beim Anbieter Ihrer Wahl die erforderliche Service Center Nummer und die Vorgehensweise zur Freischaltung des SMS-Dienstes.



Ihr Telefon ist zum Versenden von SMS-Textnachrichten vorbereitet. Es sind bereits Service Center Nummern in Ihrem Mobilteil einprogrammiert.

Empfangs Service Center	Sende Service Center
Swisscom: 0622 100 000	Swisscom: 0622 100 000

### Text eingeben

Zur Eingabe von Text sind die Zahlentasten mit Buchstaben beschriftet. Durch mehrmaliges Drücken der entsprechenden Taste können Buchstaben, Zahlen und Sonderzeichen eingegeben werden.

<b>1</b>	Leerzeichen und Sonderzeichen eingeben
<b>INT</b>	Zwischen Groß- und Kleinschreibung umschalten
<b>Löschen</b>	Letzte Stelle löschen
2 sec <b>Löschen</b>	Alles löschen und in den Standby-Modus zurückkehren

### Apparatnummer

Haben Sie mehrere SMS-fähige Telefone an Ihrem Telefonanschluss angeschlossen, wird jedes Telefon durch eine Apparatnummer identifiziert. Damit eine SMS an ein bestimmtes Telefon geschickt wird, muss der Absender der SMS-Textnachricht die Apparatnummer dieses Telefons kennen und an die Rufnummer anhängen.

### Postfächer

Neben einem bereits vorhandenen allgemeinen Postfach mit der Apparatnummer "0" können Sie vier weitere private Postfächer einrichten und durch ein Passwort schützen. Jedes Postfach wird durch einen Benutzernamen und eine Apparatnummer gekennzeichnet. Durch diese Funktion ist es möglich, SMS-Nachrichten zu erhalten, die nur der jeweilige Benutzer lesen kann.



Postfächer mit unterschiedlichen Apparatnummern können Sie nur nutzen, wenn Ihr Netzbetreiber dies unterstützt. Eine Anleitung zur Einrichtung von Postfächern erfragen Sie bitte bei Ihrem Netzbetreiber.

<sup>1</sup> **CLIP**: Calling Line Identification Presentation

<sup>2</sup> **SMS**: Short Message Service

## 10 Mehrere Mobilteile / Basisstationen

### Mehrere Mobilteile

Über den international genormten **GAP**<sup>1</sup> Standard können SWITEL-Mobilteile und auch Mobilteile von Fremdherstellern in das Telefonsystem integriert werden. Genauso können Sie ein SWITEL-Mobilteil an Basisstationen anderer Hersteller anmelden, sofern diese Geräte nach dem GAP Standard arbeiten.



Zum Abmelden eines Mobilteils von einer Basisstation benötigen Sie in jedem Fall ein weiteres an dieser Basisstation angemeldetes Mobilteil. Wenn Sie Mobilteile an einer neuen Basisstation anmelden wollen, melden Sie diese Mobilteile vorher von der alten Basisstation ab.

### Anmelden von Mobilteilen

Sie können 5 Mobilteile an Ihre Basisstation anmelden. Nach dem Anmelden wird dem Mobilteil eine interne Rufnummer gegeben. Diese interne Rufnummer wird im Display angezeigt.

#### Anmelden von CD77382-Mobilteilen an CD77382-Basisstationen

5 sec

CD77382-Basisstation in den Registriermodus bringen

Melden Sie das Mobilteil an. Seite 16

#### Anmelden von CD77382-Mobilteilen an Basisstationen anderer Hersteller

Um die Basisstation des anderen Herstellers in den Registriermodus zu bringen, folgen Sie den Hinweisen in der Bedienungsanleitung des Fremdherstellers. Benutzen Sie zur Anmeldung den PIN-Code des Fremdherstellers.

Melden Sie das Mobilteil an. Seite 16

#### Anmelden von Mobilteilen anderer Hersteller an CD77382-Basisstationen

5 sec

Basisstation in den Registriermodus bringen

Folgen Sie für die Anmeldung des Mobilteils den Hinweisen in der Bedienungsanleitung des Fremdherstellers. Benutzen Sie zur Anmeldung den aktuell eingestellten PIN-Code (Werkseinstellung: 0000).

### Mehrere Basisstationen

Ihre Mobilteile können gleichzeitig an 4 verschiedenen Basisstationen angemeldet werden. Sie können dabei CD77382-Basisstationen und auch Basisstationen anderer Hersteller verwenden, sofern diese Geräte nach dem **GAP**<sup>1</sup> Standard arbeiten. Alle Basisstationen benötigen dazu eine eigene Telefonsteckdose. Sie können die Basisstationen an Telefonsteckdosen mit der selben Rufnummer und auch an Anschlüssen mit unterschiedlichen Rufnummern anschließen.

#### Mobilität durch verschiedene Standorte

Melden Sie das Mobilteil an verschiedenen Orten an Basisstationen an. Das Mobilteil meldet sich automatisch an der nächstgelegenen Basisstation an, sofern Sie die Funktion "automatische Wahl" eingeschaltet haben. Seite 16

#### Erhöhung der Reichweite

Platzieren Sie mehrere Basisstationen so, dass sich die Reichweite der einzelnen Basisstationen überschneidet. Testen Sie gegebenenfalls die Reichweite Ihrer Mobilteile. Hindernisse in Gebäuden können die Reichweite erheblich einschränken.



Laufende Gespräche können nicht von einer zur anderen Basisstation übertragen werden.

<sup>1</sup> **GAP**: **Generic Access Profile** = Standard für das Zusammenwirken von Mobilteilen und Basisstationen anderer Hersteller.

# Falls es Probleme gibt

## 11 Falls es Probleme gibt

Haben Sie Probleme mit Ihrem Telefon, kontrollieren Sie zuerst die folgenden Hinweise. Bei Garantieansprüchen wenden Sie sich an Ihren Fachhändler.

### Fragen und Antworten

Fragen	Antworten
Keine Verbindung zur Basisstation möglich	<ul style="list-style-type: none"><li>- Prüfen Sie, ob Sie sich mit dem richtigen PIN-Code an der Basisstation angemeldet haben. ☞ Seite 16</li></ul>
Kein Telefongespräch möglich	<ul style="list-style-type: none"><li>- Die Telefonleitung ist nicht korrekt angeschlossen oder gestört. Verwenden Sie nur das mitgelieferte Telefonanschlusskabel.</li><li>- Testen Sie mit einem anderen Telefon, ob Ihr Telefonanschluss in Ordnung ist.</li><li>- Das Netzteil ist nicht eingesteckt oder es liegt ein totaler Stromausfall vor.</li><li>- Die aufladbaren Akkus sind leer oder defekt.</li><li>- Sie haben sich zu weit von der Basisstation entfernt.</li></ul>
Verbindung abgehackt, fällt aus	<ul style="list-style-type: none"><li>- Sie haben sich zu weit von der Basisstation entfernt.</li><li>- Falscher Aufstellungsort der Basisstation.</li></ul>
Das System reagiert nicht mehr	<ul style="list-style-type: none"><li>- Ziehen Sie kurzzeitig das Netzteil aus der Steckdose.</li><li>- Stellen Sie die Werkseinstellungen wieder her. ☞ Seite 21</li></ul>
Die Akkus sind in kürzester Zeit leer	<ul style="list-style-type: none"><li>- Die Akkus sind leer oder defekt.</li><li>- Stellen Sie das Mobilteil richtig auf die Basisstation. Reinigen Sie die Kontaktflächen am Mobilteil und an der Basisstation mit einem weichen, trockenen Tuch.</li><li>- Stellen Sie das Mobilteil für 14 Stunden in die Basisstation.</li></ul>
Die Rufnummernanzeige (CLIP) funktioniert nicht	<ul style="list-style-type: none"><li>- Die Rufnummernanzeige ist ein optionaler Service Ihres Netzbetreibers. Bitte fragen Sie Ihren Netzbetreiber nach weiteren Informationen.</li><li>- Der Anrufer hat das Übertragen seiner Rufnummer unterdrückt.</li></ul>
Der Anrufbeantworter nimmt keine Anrufe auf	<ul style="list-style-type: none"><li>- Stellen Sie sicher, dass der Anrufbeantworter korrekt angeschlossen und eingeschaltet ist.</li><li>- Prüfen Sie, ob der Speicher des Anrufbeantworters voll ist. Löschen Sie ggf. Nachrichten aus dem Speicher. ☞ Seite 12</li></ul>
Sie können kein Memo aufzeichnen	<ul style="list-style-type: none"><li>- Prüfen Sie, ob der Speicher des Anrufbeantworters voll ist. Löschen Sie ggf. Nachrichten aus dem Speicher. ☞ Seite 12</li></ul>
Sie können keine Fernabfrage durchführen	<ul style="list-style-type: none"><li>- Prüfen Sie, ob Sie den richtigen Sicherheitscode für die Fernabfrage benutzen. ☞ Seite 12</li><li>- Das Telefon, das Sie für die Fernabfrage nutzen wollen, muss auf Tonwahl eingestellt sein.</li></ul>

## 12 Technische Eigenschaften

### Technische Daten

Merkmal	Wert
Standard	<b>DECT<sup>1</sup>-GAP<sup>2</sup></b>
Stromversorgung	Eingang: 220/230 V, 50 Hz Ausgang: 8 V, 300 mA / 9 V, 120 mA
Reichweite	Außen: ca. 300 m Innen: ca. 50 m
Standby	über 110 h
Max. Gesprächsdauer	bis zu 12 h
Aufladbare Akkus	2 x 1.2 V, Größe: AAA
Wahlverfahren	Ton-Wahlverfahren
Zulässige Umgebungstemperatur	10°C bis 30°C
Zulässige relative Luftfeuchtigkeit	20% bis 75%
Flash-Funktion	90 ms, 250 ms

### Werkseinstellungen wiederherstellen

2 sec <input type="button" value="⓪"/>	Mobilteil ausschalten
<input type="button" value="⓪"/> , 2 sec warten, <input type="button" value="✱"/>	Mobilteil einschalten, warten und Reset einleiten
<input type="button" value="Fabrik Einstellungen"/> <input type="button" value="OK"/>	Reset bestätigen
<input type="button" value="Fabrik Einstellungen"/> <input type="button" value="Zurück"/>	Reset abbrechen

### Werkseinstellungen

	SMS Einstellungen
Sprache: Deutsch	
Mobilteil-Name: CD7738	Eingang: Leer
Interne Rufnummer:1	Ausgang: Leer
Telefonbuch: Leer (150 Speicherplätze)	Empfangs Service Center: Swisscom: 0622 100 000
Anrufliste: Leer (50 Speicherplätze)	Senden Service Center: Swisscom: 0622 100 000
Wahlwiederholung: Leer (20 Speicherplätze)	Nachrichtenton: Ein
Autom. Gesprächsan.: Ein	Warnton: Morseton
Tonruflautst.: 3	Benutzer: "Benutzer hinzufügen"
Hörerlautst.: 3	Apparatnr.: 0
Int. Tonrufmelodie: 1	<b>Basisstation</b>
Ext. Tonrufmelodie: 5	Flash-Zeit: 1 (90 ms)
Menüfarbe: Blau	Lautst. Basisstation: 3
Wecker: Aus	Tonrufmelodie Basisstation: 5
Tastensperre: Aus	PIN Code: 0000

<sup>1</sup> **DECT**: Digitally Enhanced Cordless Telephone = Standard für kabellose Telefone.

<sup>2</sup> **GAP**: Generic Access Profile = Standard für das Zusammenwirken von Mobilteilen und Basisstationen anderer Hersteller.

# Technische Eigenschaften

## Werkseinstellungen Anrufbeantworter

Ansage: Ansagetext 1	Verzögerung Anrufann.: Sechs Tonrufe
Nachrichtenspeicher: Leer	Annahme bei ausgeschaltetem AB: 20 Tonrufe
Sicherheitscode: 000	Lautstärke: 5
Anrufbeantworter: Ein	Wochentag / Uhrzeit: Saturday / 12:01 pm (nachmittags)

## 13 Pflegehinweise / Garantie

### Pflegehinweise

- Reinigen Sie die Gehäuseoberflächen mit einem weichen und fusselfreien Tuch.
- Verwenden Sie keine Reinigungsmittel oder Lösungsmittel.

### Garantie

SWITEL - Geräte werden nach den modernsten Produktionsverfahren hergestellt und geprüft. Ausgesuchte Materialien und hoch entwickelte Technologien sorgen für einwandfreie Funktion und lange Lebensdauer. Ein Garantiefall liegt nicht vor, wenn die Ursache einer Fehlfunktion des Gerätes bei dem Telefonnetzbetreiber oder einer eventuell zwischengeschalteten Nebenstellenanlage liegt. Die Garantie gilt nicht für die in den Produkten verwendeten Akkus oder Akkupacks. Die Garantiezeit beträgt 24 Monate, gerechnet vom Tage des Kaufs.

Innerhalb der Garantiezeit werden alle Mängel, die auf Material- oder Herstellungsfehler zurückzuführen sind, kostenlos beseitigt. Der Garantieanspruch erlischt bei Eingriffen durch den Käufer oder durch Dritte. Schäden, die durch unsachgemäße Behandlung oder Bedienung, durch falsches Aufstellen oder Aufbewahren, durch unsachgemäßen Anschluss oder Installation sowie durch höhere Gewalt oder sonstige äußere Einflüsse entstehen, fallen nicht unter die Garantieleistung. Wir behalten uns vor, bei Reklamationen die defekten Teile auszubessern oder zu ersetzen oder das Gerät auszutauschen. Ausgetauschte Teile oder ausgetauschte Geräte gehen in unser Eigentum über. Schadenersatzansprüche sind ausgeschlossen, soweit sie nicht auf Vorsatz oder grober Fahrlässigkeit des Herstellers beruhen.

Sollte Ihr Gerät dennoch einen Defekt innerhalb der Garantiezeit aufweisen, wenden Sie sich bitte unter Vorlage Ihrer Kaufquittung ausschließlich an das Geschäft, in dem Sie Ihr SWITEL - Gerät gekauft haben. Alle Gewährleistungsansprüche nach diesen Bestimmungen sind ausschließlich gegenüber Ihrem Fachhändler geltend zu machen. Nach Ablauf von zwei Jahren nach Kauf und Übergabe unserer Produkte können Gewährleistungsrechte nicht mehr geltend gemacht werden.

# Index

## 14 Index

### A

Akkuladezustand, 5  
Akkus aufladen, 5  
Akkus einsetzen, 5  
Alle Nachrichten / Memos löschen, 12  
Amtskennziffer, 14  
Anmelden von Mobilteilen, 16, 19  
Anruf annehmen, 9  
Anruf übernehmen, 11  
Anrufbeantworter, 11  
Anrufbeantworter ein- / ausschalten, 11  
Anrufbeantworter im Telefonnetz, 14  
Anrufen, 9  
Anruflisten, 15  
Ansagemodus wählen, 11  
Ansgagen aufzeichnen, 12  
Ansgagen löschen, 12  
Apparatnummer, 18

### B

Basisstation anschließen, 5  
Bedienelemente, 6

### D

Darstellungen, 7  
Datum und Uhrzeit einstellen, 5, 16

### E

Eingegangene Anrufe zurückrufen, 9  
Erhöhung der Reichweite, 19  
Externe Gespräche intern weiterleiten, 9

### F

Fernabfrage, 12  
Feineinschalten des Anrufbeantworters, 13  
Fragen und Antworten, 20  
Freisprechen, 10

### G

Garantie, 23  
Gebührensparer, 11  
Gespräch beenden, 9  
Gesprächsdauer, 10

### H

Hauptmenü, 15  
Hörerlautstärke, 10

### I

Intern telefonieren, 9  
Interne Gespräche führen, 9

### K

Konferenzgespräche führen, 10

### L

Ladestation anschließen, 5  
Lautstärke des Anrufbeantworters einstellen, 11

### M

Makeln, 9  
Maximale Aufnahmezeit, 11  
Mehrere Basisstationen, 19  
Mehrere Mobilteile, 19  
Memo aufzeichnen, 12  
Menüstruktur, 15  
Mikrofon stummschalten, 10  
Mobilität, 19  
Mobilteil aus- und einschalten, 5  
Mobilteil suchen, 10

### N

Nachrichten / Memos abhören, 12  
Nachrichten / Memos löschen, 12  
Navigation im Menü, 8  
Navigationstasten, 8  
Nebenstellenanlagen, 5, 14

### P

Paging, 10  
Pflegehinweise, 23  
Postfächer, 18

### R

R-Taste an Nebenstellenanlagen, 14  
R-Taste und Zusatzdienste, 14  
Reset, 21  
Rücksprache, 9  
Rufnummern aus dem Telefonbuch wählen, 9  
Rufnummernanzeige, 14

### S

Schreibweisen, 7  
Sicherheitscode für die Fernabfrage, 12  
Sicherheitshinweise, 4  
SMS, 15, 18  
SMS Service Center, 18  
SMS Voraussetzungen, 18  
Sprache des Anrufbeantworters einstellen, 11  
Symbole im Display, 7

### T

Tastenfunktionen, 13  
Tastensperre, 10  
Technische Daten, 21  
Telefon in Betrieb nehmen, 5  
Telefonbuch, 17  
Telefonbucheinträge erstellen, 8  
Telefonieren, 9  
Text eingeben, 18

### V

Verpackungsinhalt, 5  
Verzögerung der Anrufannahme, 11  
VMWI, 14

### W

Wahlpause, 14  
Wahlwiederholung, 9  
Werkseinstellungen wiederherstellen, 21  
Wie bediene ich mein Telefon?, 7  
Wochentag und Uhrzeit des Anrufbeantworters einstellen, 11

### Z

Zugangskode, 14  
Zusatzdienste, 14



1	Consignes de sécurité . . . . .	26
2	Mise en service du téléphone . . . . .	27
3	Éléments de manipulation . . . . .	28
4	Comment se servir du téléphone . . . . .	29
5	Comment téléphoner . . . . .	31
6	Répondeur . . . . .	33
7	Installations à postes supplémentaires / Services supplémentaires . . . . .	36
8	Structure du menu . . . . .	37
9	SMS . . . . .	40
10	Plusieurs combinés / bases . . . . .	41
11	En cas de problèmes . . . . .	42
12	Caractéristiques techniques . . . . .	43
13	Remarques d'entretien / Garantie . . . . .	45
14	Index . . . . .	46

# Consignes de sécurité

## 1 Consignes de sécurité

Lisez très attentivement ce mode d'emploi.

### Utilisation conforme aux prescriptions

Ce téléphone convient pour téléphoner à l'intérieur d'un réseau téléphonique. Toute autre utilisation est considérée comme non conforme à l'usage. Des modifications ou changements effectués d'un propre gré ne sont pas autorisés. N'ouvrez en aucun cas l'appareil et n'effectuez aucun essai de réparation vous-même.

### Lieu d'installation

Évitez toute nuisance par la fumée, la poussière, les tremblements, les produits chimiques, l'humidité, la grande chaleur ou l'ensoleillement direct.

N'utilisez pas le combiné dans des zones exposées aux explosions.

### Bloc secteur



**Attention :** N'utilisez que le bloc d'alimentation enfichable fourni avec l'appareil, d'autres pouvant détruire votre téléphone. Vous ne devez pas bloquer son accès par des meubles ou autres objets.

### Piles rechargeables



**Attention :** Ne jetez pas les piles dans le feu ou ne les plongez pas dans l'eau.

### Panne de courant

En cas de panne de courant, vous ne pouvez pas téléphoner avec cet appareil. Pour les cas d'urgence, ayez à votre disposition un téléphone à fil fonctionnant sans alimentation externe en courant.

### Appareils médicaux



**Attention :** N'utilisez pas le téléphone à proximité d'appareils médicaux. Leur influence réciproque ne peut pas être entièrement exclue.

**DECT<sup>1</sup>**- Les téléphones DECT peuvent causer un bourdonnement désagréable dans les prothèses auditives.

### Élimination

La loi vous oblige à éliminer de manière appropriée les biens de consommation. L'icône ci-contre sur votre téléphone signifie que les anciens appareils électriques et électroniques doivent être éliminés séparément des ordures ménagères.

**Éliminez les appareils électriques ou électroniques** dans le centre de collecte d'un organisme approprié d'évacuation des déchets.

**Éliminez les piles** auprès d'un revendeur spécialisé ainsi que dans des centres de collecte qui tiennent à votre disposition les collecteurs appropriés correspondants.

**Éliminez les matériaux d'emballage** conformément au règlement local.



<sup>1</sup> DECT: Digitally Enhanced Cordless Telephone = Standard pour téléphones sans fil.

## 2 Mise en service du téléphone

### Remarques concernant la sécurité



**Attention :** Avant de mettre votre appareil en service, lisez impérativement les consignes de sécurité mentionnées au chapitre 1.

### Vérifier le contenu de l'emballage

Les éléments suivants font partie de la livraison :

- une base avec bloc d'alimentation
- deux combinés
- un chargeur avec bloc d'alimentation
- un câble de raccordement téléphonique
- quatre piles rechargeables
- un mode d'emploi

### Raccordement de la base



**Attention :** Posez la base à une distance d'1 m des autres appareils électroniques pour éviter d'éventuelles perturbations.

Raccordez la base tel que décrit sur le croquis. Pour des raisons de sécurité, n'utilisez que le bloc d'alimentation fourni avec l'appareil ainsi que le câble de raccordement téléphonique ci-joint.

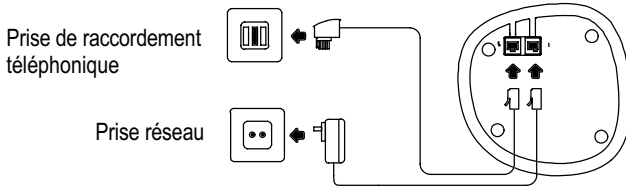

### Raccordement du chargeur

Raccordez le chargeur tel que représenté sur le croquis. Pour des raisons de sécurité, n'utilisez que le bloc d'alimentation fourni avec l'appareil.

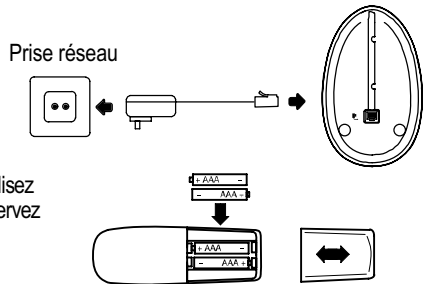

### Mise en place des piles

Placez les piles dans le compartiment prévu à cet effet. N'utilisez que des piles rechargeables de type AAA Ni-MH 1,2 V. Observez une polarisation correcte ! Fermez le compartiment à piles.

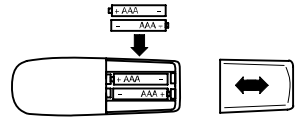

### Chargement des piles rechargeables

Lors de la première mise en service, posez le combiné pendant au moins 14 heures sur sa base / le chargeur. Si vous avez posé correctement le combiné sur la base / le chargeur, le voyant de charge s'allume. Le combiné chauffe lors du chargement. C'est normal et inoffensif. Ne chargez pas le combiné avec des chargeurs d'un autre fabricant. Le niveau actuel de **chargement des piles** est affiché sur l'écran :



Plein



Moyen



Faible



Vide

### Branchement et débranchement du combiné

Afin de ménager les piles rechargeables standard, vous pouvez brancher et débrancher le combiné.

2 sec

Débranchement du combiné

Branchement du combiné

### Réglage de l'heure et de la date

La page 38 vous dira comment régler la date et l'heure de votre combiné lors de sa première mise en service.

### Installations à postes supplémentaires

A la page 36, vous trouverez de plus amples informations concernant le raccordement de votre téléphone à une installation à postes supplémentaires.

# Éléments de manipulation

## 3 Éléments de manipulation

### Combiné

- 1 Feuilleter vers le haut / Liste de répétition automatique des derniers numéros
- 2 Touche softkey droite
- 3 Raccrocher / Brancher, débrancher le combiné
- 4 Verrouillage du clavier / conférences téléphoniques
- 5 Communications internes
- 6 Touche R
- 7 Feuilleter vers le bas / Appels manqués
- 8 Décrocher / Mode mains-libres
- 9 Touche softkey gauche

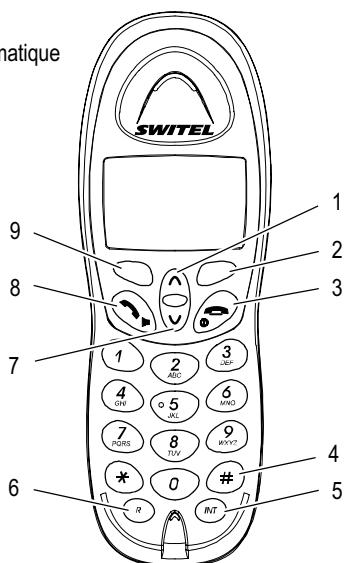

### Base (répondeur)

- 1 Touche de paging (recherche du combiné)
- 2 Volume sonore -
- 3 Répondeur Marche / Arrêt
- 4 Volume sonore +
- 5 Message précédent / Enregistrement d'un mémo
- 6 Stop
- 7 Ecoute / Enregistrement de l'annonce
- 8 DEL affichage réseau
- 9 Message suivant / Retardement de la prise d'appel
- 10 Effacement / Code de sécurité
- 11 DEL voyant de charge
- 12 Écoute

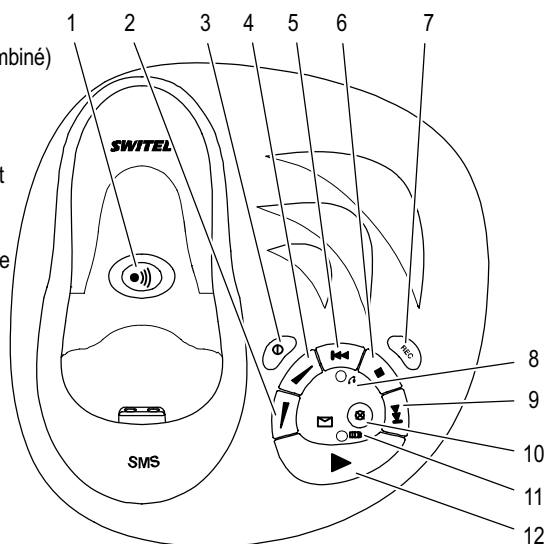

### Chargeur

- 1 DEL voyant de charge

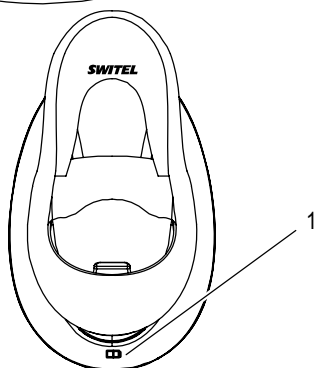

Les touches sont représentées dans ce mode d'emploi par un contour uniforme. Les symboles de votre téléphone peuvent présenter des différences par rapport à ceux représentés ici.

## 4 Comment se servir du téléphone

### Représentations et notations

	Saisir des chiffres ou des lettres
	Appuyer rapidement sur la touche représentée
2 sec	Appuyer 2 secondes sur la touche représentée
Maintenir	Maintenir appuyée la touche représentée
Relâcher	Relâcher la touche représentée
	Le combiné sonne
	La base sonne
	Retirer le combiné de la base
	Poser le combiné sur la base
Ajouter aux contacts	Texte et symboles à l'écran
Options	Appuyer sur la touche softkey  page 30 Touches de navigation

### Symboles à l'écran

Symbole	Description
	En continu : Affichage de la capacité des piles. Clignotant : Chargez les piles rechargeables. Segments continus : Les piles rechargeables sont en train d'être chargées.  page 27
	Le mode mains-libres est activé.  page 32
	Le verrouillage du clavier est activé.  page 32
	Le "Alarme" est activé.  page 38
	De nouveaux appels sont enregistrés dans la liste d'appels (CLIP).  page 36
	Vous avez un nouveau SMS <sup>1</sup> .  page 41
	Répondeur dans le réseau téléphonique. VMWI <sup>2</sup> - Service optionnel de votre opérateur  page 36
	En continu: La liaison avec la base est bonne. Clignotant: La liaison avec la base n'est pas bonne. Rapprochez-vous de la base.
1	Numéro d'appel interne du combiné  page 42
20:22	Affichage de l'heure  page 38
SWITEL	Affichage du nom du combiné  page 38

<sup>1</sup> SMS : Short Message Service

<sup>2</sup> VMWI : Visual Message Waiting Indication



# Comment se servir du téléphone

## Touches de navigation

Toutes les descriptions de ce mode d'emploi partent du principe que le combiné se trouve en mode d'attente. Vous obtenez le mode d'attente en appuyant sur la touche .

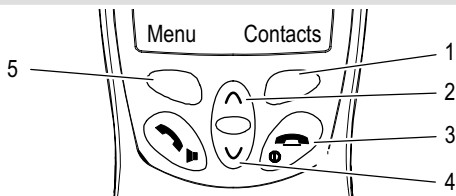







 Les touches softkey (1) et (5) sont occupées par différentes fonctions dans les différents menus. Dans ce mode d'emploi, elles sont toujours dénommées selon les textes inscrits ci-dessus à l'écran.



Touche	En mode de veille	Dans le menu
1	- ouvrir le répertoire	- reculer d'une position
2 	- ouvrir la liste de répétition automatique des derniers numéros	- feuilleter dans les menus - modifier les paramètres
3 	- brancher, débrancher le combiné	- interrompre les opérations de programmation et de sauvegarde
4 	- ouvrir la liste des appels manqués	- feuilleter dans les menus - modifier les paramètres
5	- ouvrir le menu principal	- ouvrir le menu affiché

## Navigation dans le menu





Vous pouvez accéder à toutes les fonctions via différents menus. La structure du menu vous indique le chemin à prendre jusqu'à la fonction désirée.  page 37

<b>Menu</b>	Ouvrir le menu principal
 ou 	Sélectionner le sous-menu désiré
<b>OK</b>	Ouvrir le sous-menu
 ou 	Sélectionner la fonction désirée
<b>OK</b>	Ouvrir la fonction
 ou 	Sélectionner le réglage désiré
	Saisir des chiffres ou des lettres via le pavé numérique.
<b>OK</b>	Confirmer les entrées
<b>Retour</b>	Reculer d'une position
	Interrompre les opérations de programmation et de sauvegarde et retourner en mode de veille

 Chaque opération est automatiquement interrompue si vous n'effectuez pas de saisie dans les 60 secondes.

## Exemple

L'exemple "créer des enregistrements dans le répertoire" explique comment vous naviguez dans les menus et effectuez des saisies. Pour tous les réglages, procédez comme dans cet exemple.

<b>Contacts</b>	Ouvrir le répertoire
<b>Options</b>  ou 	
<b>Ajouter aux contacts</b> , <b>OK</b>	Sélectionner la fonction et confirmer
 , <b>OK</b>	Saisir le nom et confirmer
 , <b>OK</b>	Saisir le numéro et confirmer

## 5 Comment téléphoner

### Prise d'appel

 Prendre l'appel

### Fin de la communication

 Terminer la communication

### Appeler

 Composer le numéro d'appel (max. 25 chiffres)

**Effacer** En cas d'erreur de saisie, effacer le dernier chiffre

 Composer le numéro

 Vous pouvez également appuyer tout d'abord sur la touche de communication, vous obtenez ainsi la tonalité. Les chiffres saisis de votre numéro d'appel seront immédiatement composés. La correction individuelle des chiffres du numéro d'appel n'est pas possible quand la communication est établie de cette manière.

### Touche de répétition automatique des derniers numéros

Votre téléphone enregistre les 20 derniers numéros composés dans une liste de répétition des derniers numéros.

 Ouvrir la liste de répétition automatique des derniers numéros

 ou ,  Sélectionner l'enregistrement et confirmer

### Rappel des appels entrés

Votre téléphone enregistre les 20 appels manqués dans une liste d'appels.

 Ouvrir la liste d'appels

 ou ,  Sélectionner l'enregistrement et confirmer

### Composition de numéros du répertoire

Vous devez avoir enregistré des numéros d'appel dans le répertoire.  page 30 et 40

**Contacts** Ouvrir le répertoire

 ou ,  Sélectionner l'enregistrement et confirmer

### Communication interne

#### Comment passer des communications internes

Vous devez avoir déclaré deux combinés ou plus (MT1, MT2, ...) sur une base pour pouvoir passer des communications internes gratuites.

MT1: **INT**, par ex. **2** Composer le numéro d'appel interne du combiné de votre choix

MT2:  Prendre la communication interne sur l'autre combiné

MT1 / MT2:  Terminer la communication interne

#### Comment transférer des communications externes à des internes

MT1: **INT**, par ex. **2** Pendant la communication externe, composer le numéro d'appel interne

MT2:  Prendre la communication interne sur l'autre combiné

MT1:  Transférer la communication

 Si le combiné appelé ne réagit pas, vous pouvez reprendre la communication externe en appuyant sur la touche **INT**.

#### Intercommunication / va-et-vient

Vous pouvez, pendant une communication externe, sélectionner un autre combiné pour intercommuniquer. Le correspondant externe est maintenu en ligne pendant que vous parlez avec le correspondant interne. Vous pouvez changer de correspondant autant de fois que vous le désirez.

MT1: **INT**, par ex. **2** Composer le numéro d'appel interne pendant la communication externe





MT2:  Prendre la communication interne sur l'autre combiné

MT1: **INT** Changer de correspondant

# Comment téléphoner



## Comment mener des conférences téléphoniques

Une communication externe peut être branchée sur un autre correspondant interne dans le but de mener une conférence.

MT1:  , par ex. 	Composer le numéro d'appel interne pendant la communication externe
MT2: 	Prendre la communication interne sur l'autre combiné
MT1: 2 sec 	Commencer la conférence
MT1 / MT2: 	La conférence se termine quand un correspondant interne raccroche

## Régler le volume sonore de l'écouteur

Vous disposez de 5 niveaux pour régler le volume pendant une communication.



 ou 	Appuyer pendant la communication
--	----------------------------------

## Affichage de la durée de la communication

La durée d'une communication est affichée en minutes et secondes.

## Mode mains-libres

Utilisez cette fonction pour entendre le correspondant par l'intermédiaire du haut-parleur.

 	Brancher le mode mains-libres
	Débrancher le mode mains libres



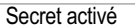
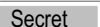

## Débranchement du microphone du combiné

Pendant une communication, vous pouvez activer et désactiver le microphone du combiné.

 	Débrancher le microphone (secret)
	Brancher le microphone





## Verrouillage du clavier

Lorsque le verrouillage du clavier est activé, vous pouvez comme d'habitude réceptionner des appels entrants.

2 sec  /  	Activer le verrouillage du clavier
 , 	Désactiver le verrouillage du clavier

## Comment chercher le combiné (Paging)

Si vous avez perdu votre combiné, vous pouvez le retrouver facilement grâce à un son explorateur.

 	Démarrer le son explorateur
 ou 	Terminer le son explorateur



## 6 Répondeur



Votre répondeur dispose d'un guide parlé de l'utilisateur. Tenez compte de ces instructions et remarques.

### Réglage de la langue

La reproduction vocale du répondeur est en anglais et n'est pas modifiable.

### Réglage du jour de la semaine et de l'heure

À l'écoute des messages, le jour de la semaine et l'heure de leur entrée seront indiqués à chaque message.

2 sec	Activer le mode de réglage
ou ,	Régler le jour de la semaine et confirmer
ou ,	Régler les heures et confirmer
ou ,	Régler les minutes et confirmer

### Ecoute du jour de la semaine et de l'heure

	Ecoute du jour de la semaine et de l'heure paramétrés
--	---

### Branchement / débranchement du répondeur

	Branchement / débranchement du répondeur
--	--

### Durée d'enregistrement maximale

Le répondeur enregistre jusqu'à 60 messages. La durée d'enregistrement maximum est de 16 minutes. La longueur maximale de chaque message est de 2 minutes. Si la capacité de la mémoire est saturée et ne peut plus recevoir de nouveaux messages, plus aucun appel ne sera enregistré.

### Réglage du volume sonore

Vous pouvez régler le volume sonore sur 11 niveaux.

ou	Réglage du volume sonore
----	--------------------------

### Prise d'appel retardée

Vous pouvez choisir entre 2 et 9 sonneries d'appel ainsi que le réglage **économiseur de taxes** pour la consultation préalable à distance gratuite. La consultation préalable à distance gratuite vous permet de constater si vous avez de nouveaux messages sur votre répondeur.

- S'il y a de nouveaux messages sur votre répondeur, votre appel sera pris dès la 2<sup>e</sup> sonnerie.
- Si aucun message n'a été enregistré, votre appel ne sera pris qu'au bout de la 4<sup>e</sup> sonnerie. Raccrochez avant la 4<sup>e</sup> sonnerie. Vous n'aurez ainsi pas de frais à payer.

Maintenir	Activer le mode de réglage
Relâcher	Sélectionner le réglage

Autres informations relatives à la consultation à distance page 34

### Prise d'appel

Si le répondeur a déjà répondu à un appel, vous pouvez reprendre celui-ci. L'enregistrement du message est, dans ce cas, interrompu.

ou	Reprendre l'appel
----	-------------------

### Sélection du mode d'annonce

Votre répondeur met à votre disposition deux textes d'annonce préenregistrés. Après le texte d'annonce 1, il est possible de laisser un message. Dans le cas du texte d'annonce 2, il s'agit d'une annonce seulement après laquelle il n'est pas possible de laisser de message. Vous pouvez remplacer le texte d'annonce 1 et le texte d'annonce 2 par un propre texte d'annonce. Si la mémoire du répondeur est pleine, c'est le texte d'annonce 2 qui se fera automatiquement entendre.





2 sec <b>REC</b>	Activer le mode de réglage
	Activer le texte d'annonce 1
	Activer le texte d'annonce 2

# Répondeur

## Enregistrement / contrôle et effacement des annonces

### Enregistrement des annonces

La longueur de la propre annonce ne doit pas dépasser 40 secondes.



2 sec 	Activer le mode de réglage
Maintenir 	Démarrer l'enregistrement (texte d'annonce 1)
Relâcher 	Terminer l'enregistrement (texte d'annonce 1)
Maintenir 	Démarrer l'enregistrement (texte d'annonce 2)
Relâcher 	Terminer l'enregistrement (texte d'annonce 2)

### Contrôle de l'annonce actuellement enregistrée

	Ecouter l'annonce
---	-------------------

### Suppression d'une annonce personnelle et retour à l'annonce standard

Si vous effacez votre propre annonce, c'est l'annonce standard préenregistrée qui sera automatiquement activée.



	Ecouter l'annonce
	Effacer l'annonce

### Enregistrement d'un mémo

Un mémo est une information qui peut être écoutée comme un message entré.

### Enregistrement d'un mémo





La durée du mémo peut s'élever jusqu'à 2 minutes.

Maintenir 	Démarrer l'enregistrement
Relâcher 	Terminer l'enregistrement



### Ecoute / suppression de messages / mémos enregistrés

#### Ecoute de messages / de mémos

Les messages / mémos enregistrés sont restitués dans l'ordre dans lequel ils ont été enregistrés. Le jour de la semaine et l'heure sont annoncés avant l'audition du message ou du mémo correspondant.



2 sec 	Ecouter de nouveaux message / mémos
	Ecouter tous les messages / mémos
	Arrêt de la restitution
	Faire repasser le message
	Message suivant

#### Suppression d'un message / mémo

	Ecouter le message / mémo à effacer
	Effacer le message / mémo

### Supprimer tous les messages / mémos

Tous les message / mémos seront effacés. Les nouveaux messages / mémos seront également effacés. Ecoutez tous les messages / mémos. Après que vous avez écouté tous les messages / mémos, vous pouvez effacer tous les messages / mémos.











	Ecouter tous les messages / mémos
	Effacer les messages / mémos

### La consultation à distance

Vous pouvez appeler votre répondeur pour écouter les messages et effectuer d'autres fonctions. A condition toutefois d'utiliser un téléphone à numérotation par tonalité.

### Le code de sécurité pour la consultation à distance

Pour pratiquer la consultation à distance, vous devez saisir un code de sécurité. Celui-ci est réglé à l'usine sur le "000".

2 sec 	Activer le mode de réglage
 ou  , 	1. Modifier le 1er numéro et confirmer
 ou  , 	2. Modifier le 2ème numéro et confirmer
 ou  , 	3. Modifier le 3ème numéro et confirmer

## Démarrer la consultation à distance



Composer le numéro d'appel personnel



Appuyer sur ces touches pendant l'annonce et saisir le code de sécurité



En cas de saisie erronée, écoutez à nouveau l'annonce du répondeur. Si le code de sécurité a été saisi trois fois de manière erronée, la ligne sera automatiquement coupée.

Vous avez maintenant la possibilité d'exécuter d'autres fonctions. Tableau des fonctions de touche

## Branchement à distance du répondeur



Composer le numéro d'appel personnel



Si vous avez oublié de brancher votre répondeur, votre appel ne sera pris qu'au bout de 20 sonneries.



Appuyer sur ces touches après le signal sonore et saisir le code de sécurité



Brancher / débrancher le répondeur

Vous avez maintenant la possibilité d'exécuter d'autres fonctions. Tableau de fonctions des touches

## Fonctions des touches de la consultation à distance



La consultation à distance est automatiquement interrompue si vous n'effectuez pas de saisie dans les 10 secondes.

Les fonctions des touches sont dépendantes du menu dans lequel vous vous trouvez. Le tableau suivant vous donne une vue d'ensemble des fonctions de chaque touche.

Touche	1 Fonctions du menu principal	8 Fonctions du menu d'annonces
1	Nouvelle écoute du menu principal	Ouvrir le menu principal et l'écouter
2	Ecoute de tous les messages	Ecoute du texte d'annonce préenregistré
3	Ecoute des nouveaux messages seulement	Enregistrement du texte d'annonce 1  page 34
4	Nouvelle écoute du message en cours	Enregistrement du texte d'annonce 2  page 34
5	- Effacement du message en cours - Effacement de tous les messages (après que tous les messages / mémos ont été écoutés)	- Activation du texte d'annonce 1  page 34 - Effacement du texte d'annonce 1 ou 2 (écouter le texte d'annonce et l'effacer pendant sa restitution)
6	Ecoute du message suivant	Activation du texte d'annonce 2  page 34
7	Branchement / débranchement du répondeur	
8	Ouverture et écoute du menu des annonces	Nouvelle écoute du menu des annonces
9	Paramétrage du code de sécurité Activer le code de réglage : * Paramétrer le code de sécurité : par ex. "000" = 0, 0, 0 Confirmer le paramétrage : #	
0	Réglage du jour de la semaine et de l'heure Activer le mode de réglage : * Régler le jour de la semaine : Lundi = 1, Mardi = 2, Mercredi = 3, Jeudi = 4, Vendredi = 5, Samedi = 6, Dimanche = 7 Réglage de l'heure : par ex. 10:15 heures = 1, 0, 1, 5 Confirmer le paramétrage : #	
*	Activation du mode de réglage	
#	Confirmation du réglage	Fin de l'enregistrement
	Raccrocher pour terminer la consultation à distance.	

# Installations à postes supplémentaires / Services supplémentaires

## 7 Installations à postes supplémentaires / Services supplémentaires

### Touche R sur les installations à postes supplémentaires

Si votre téléphone est raccordé à une installation à postes supplémentaires, vous pouvez, par l'intermédiaire de la touche **R**, tirer profit des fonctions comme par ex. le transfert d'appels et le rappel automatique. Veuillez lire dans le mode d'emploi de votre installation à postes supplémentaires quel temps de flash vous devez régler pour l'utilisation de ces fonctions. Votre revendeur, auprès duquel vous avez acheté l'installation, vous informera si votre téléphone fonctionne parfaitement sur ce genre d'installation. Réglage du temps de flash  page 38

### Code d'accès (chiffre de la ligne principale)

Dans le cas d'installations à postes supplémentaires, il est nécessaire de composer auparavant un code réseau pour obtenir la tonalité. Si vous avez enregistré et activé un chiffre de la ligne principale dans votre combiné, ce chiffre sera automatiquement composé en premier avant les numéros d'appel du répertoire et ceux des listes des appels.

### Pause de numérotation

Dans le cas d'installations à postes supplémentaires, il est nécessaire de composer auparavant un code réseau pour obtenir la tonalité. Sur les quelques installations à postes supplémentaires plus anciennes, cela dure quelques instants jusqu'à ce que vous entendiez la tonalité. Pour ces installations à postes supplémentaires, une pause de numérotation peut être insérée après le code réseau afin de pouvoir continuer à numéroté directement sans attendre la tonalité.

2 sec  Introduire la pause de numérotation

Après le code réseau, votre téléphone attend 3 secondes pour composer le numéro d'appel réel.

 La pause peut également être enregistrée dans le répertoire lors de la saisie de numéros d'appel.

### Touche R et services supplémentaires

Votre téléphone supporte des services supplémentaires de votre opérateur, comme par ex. le va-et-vient, la signalisation d'appel en instance et la conférence. Vous pouvez utiliser ces services supplémentaires par l'intermédiaire de la touche **R**. Demandez à votre opérateur quel temps de flash vous devez régler pour utiliser ces services supplémentaires. Contactez votre opérateur pour déconnecter les services supplémentaires. Réglage du temps de flash  page 38

### Répondeur dans le réseau téléphonique

Si votre opérateur met à votre disposition un répondeur dans le réseau téléphonique, vous serez informé de l'existence de nouveaux messages par un symbole (**VMWI**<sup>1</sup>) Le répondeur et l'information relative aux nouveaux messages indiquée par un symbole sont des services optionnels de votre exploitant de réseau. Vous ne pouvez disposer de ces fonctions que si ce dernier supporte ce service. Veuillez lui demander de plus amples informations.

### Affichage du numéro d'appel (CLIP<sup>2</sup>)

Si cette fonction est à votre disposition sur votre ligne téléphonique, le numéro du correspondant vous sera affiché dès que le téléphone sonne. Si votre correspondant a bloqué la transmission de son numéro, un message correspondant sera affiché. Le numéro d'appel ne peut pas être affiché et donc être enregistré dans la liste des appels.

 L'affichage du numéro d'appel est un service optionnel de votre exploitant de réseau. Veuillez lui demander de plus amples informations.

<sup>1</sup> **VMWI** : Visual Message Waiting Indication

<sup>2</sup> **CLIP** : Calling Line Identification Presentation

## 8 Structure du menu

### Menu principal

Vous accédez au menu principal en appuyant sur la touche softkey. **Menu**.

SMS <sup>1</sup>	Ecrire un message	Options	Envoyer à	Chercher
			Enregistrer	
			Insérer symbole	
			Nom Utilisateur	Boite commune
				Boîtes personnelles 1-4
				Mot de Passe
	Messages reçus	Lire	Options	Répondre
				Transférer
				Effacer
	Archives	Lire	Options	Modifier
	Effacer messages	Messages reçus		Envoyer à
		Archives		Effacer
		Effacer tout		Nom Utilisateur
	Réglages	Centres serveurs	Serveur Réception	Serveur Réception
			Serveur Emission	Serveur Emission
		Numéro de Terminal	Numéro de Terminal	
		Alertes	Marche/arrêt	
			Configuration Alerte	Morse
				Discrète
				Polyphonique
		Boîtes personnelles	Supprimer	Boîtes personnelles 1-4
			Ajouter boite perso.	Nom Utilisateur
			Mot de Passe	Confirmer

Liste des appels <sup>2</sup>	Appels reçus	Options	Effacer
			Voir les détails
			Ajouter un contact
	Appel non répondu	Options	Effacer
			Voir les détails
			Ajouter un contact
	Numéros composés	Options	Effacer
			Voir les détails
			Ajouter un contact
	Effacer listes	Appels reçus	
		Appel non répondu	
		Numéros composés	
		Tous les appels	

<sup>1</sup> Autres informations relatives aux messages écrits SMS ➤ page 40

<sup>2</sup> L'affichage du numéro d'appel (**CLIP**<sup>3</sup>) est nécessaire pour l'affichage et la sauvegarde de numéros d'appel dans les listes des appels. L'affichage du numéro d'appel est un service optionnel de votre exploitant de réseau. Veuillez lui demander de plus amples informations. Autres informations relatives à l'affichage du numéro d'appel ➤ page 36

<sup>3</sup> **CLIP** : Calling Line Identification Presentation

## Structure du menu

Combiné	Sonnerie	Appels externes	Mélodie base 1-5
		Appels internes	Mélodie base 1-5
	Volume de sonnerie	Volume de sonnerie 1-5 / Arrêt	
	Nom du combiné	☎ Contact	
	Choix langue <sup>1</sup>	Choix langue 1-7	
	Couleurs du menu	Bleu	
		Vert	
		Rose	
	Décroché automatique <sup>2</sup>	Marche/arrêt	
	Code d'accès <sup>3</sup>	Marche/arrêt	
☎ Saisir le code			

Configuration base	Sonnerie base	Mélodie base 1-5		
	Volume base	Volume base 1-5 / Arrêt		
	Priorité de sonnerie <sup>4</sup>	Tous les combinés		
		Sélection combiné	Combiné 1-5	Sonneries 2
				Sonneries 4
				Sonneries 6
	Touche	Court (100 ms)		
		Long (300 ms)		
	Code Base <sup>5</sup>	☎ Ancien code :	☎ Nouveau code :	▶
			▶ ☎ Confirmer code :	

Réglage date & heure	Alarme	Marche/arrêt	Une seule sonnerie	☎ Horloge sur 24H
			Quotidienne	☎ Horloge sur 24H
			Arrêt	
		Sonnerie alarme	Sonnerie alarme 1-4	
		Réglage date & heure	☎ Date	☎ Horloge sur 24H

Enregistrement	Déclaration combiné	Base 1-4	☎ Code Base <sup>5</sup>
	Choix de la base	Automatique	
		Base 1-4	
	Suppression Combiné	☎ Code Base <sup>5</sup>	Combiné 1-5

<sup>1</sup> Langues : anglais, français, allemand, italien, espagnol, hollandais et portugais.

<sup>2</sup> Si vous avez activé la fonction, un appel sera automatiquement pris en communication lorsque le combiné sera retiré de la base.





<sup>3</sup> Autres informations relatives aux installations à postes supplémentaires ☎ chapitre 7.

<sup>4</sup> Vous pouvez ici choisir si un appel entrant doit sonner sur tous les combinés déclarés ou s'il doit seulement sonner sur un combiné bien précis.

<sup>5</sup> Réglage usine du PIN système : 0000

## Répertoire

Vous accédez au répertoire en appuyant sur la touche softkey. **Contacts** .

Enregistrement 1	Options	Ajouter un contact	 Contact 1	 Numéro :
Enregistrement 2		Voir les détails		
Enregistrement...		Effacer un contact		
		Modifier un contact	 Contact 1	 Numéro :
		Sonnerie <sup>2</sup>	Arrêt	
			Mélodie base 1-5	
		Effacer les contacts		

<sup>1</sup> Des lettres sont inscrites sur les touches de chiffres. En appuyant plusieurs fois sur la touche adéquate, vous pouvez saisir des lettres, des chiffres et des symboles.

<sup>2</sup> Ici, vous pouvez attribuer une certaine mélodie de sonnerie d'appel à un enregistrement du répertoire. Votre combiné se manifeste alors avec la mélodie de sonnerie paramétrée lorsqu'un appel de ce correspondant vous parvient. L'affichage du numéro d'appel (**CLIP**<sup>3</sup>) est nécessaire pour cette fonction. L'affichage du numéro d'appel est un service optionnel de votre exploitant de réseau. Veuillez lui demander de plus amples informations.

<sup>3</sup> **CLIP** : Calling Line Identification Presentation

# SMS

## 9 SMS

### Conditions SMS

Votre raccordement téléphonique doit disposer du service **CLIP**<sup>1</sup>. Assurez-vous auprès de votre opérateur que ce service est bien activé sur votre raccordement téléphonique. Pour utiliser le service **SMS**<sup>2</sup>, celui-ci doit être activé auprès de votre exploitant de réseau.

- Vous ne pouvez pas envoyer de SMS à partir d'installations à postes supplémentaires.
- Les envois SMS ne sont pas encore possibles avec les connexions d'appel par appel.
- Les envois de messages SMS sont payants.
- Si le récepteur n'utilise pas de service SMS sur son réseau fixe ou si son téléphone ne peut simplement pas recevoir de SMS, le SMS sera automatiquement livré sous forme de message vocal.
- Le calcul des frais est effectué par votre opérateur.

### Centre de services SMS

La distribution de messages SMS se fait par un centre de services ou centre serveur. Si vous désirez envoyer des messages écrits SMS, vous devez programmer un numéro de centre de services dans votre combiné (page 37). Veuillez demander au fournisseur de votre choix le centre de services nécessaire et la façon de procéder pour activer le service SMS.

 Votre téléphone est prêt à envoyer des messages écrits SMS. Des numéros de centres de services sont déjà programmés dans votre combiné.

Centre de services de réception	Centre de services d'émission
Swisscom: 0622 100 000	Swisscom: 0622 100 000

### Saisie de texte

Pour permettre la saisie de textes, des lettres sont inscrites sur les touches chiffrées. En appuyant plusieurs fois sur la touche adéquate, vous pouvez saisir des lettres, des chiffres et des symboles.

<b>1</b>	Saisie d'espaces et de signes particuliers
<b>INT</b>	Changez entre majuscule et minuscule
<b>Effacer</b>	Effacer la dernière position
2 sec <b>Effacer</b>	Tout effacer et retourner au mode de veille

### Numéro d'appareil

Si vous avez connecté plusieurs téléphones à fonction SMS à votre raccordement téléphonique, chaque téléphone est identifié par un numéro d'appareil. Pour qu'un SMS soit envoyé à un téléphone précis, l'expéditeur du message écrit SMS doit connaître le numéro d'appareil de ce téléphone et l'ajouter au numéro de téléphone.

### Boîtes postales

En plus d'une boîte commune déjà existante portant le numéro d'appareil "0", vous pouvez ouvrir quatre autres boîtes personnelles et les protéger par un mot de passe. Chaque boîte est caractérisée par un nom d'utilisateur et un numéro d'appareil. Cette fonction vous permet de recevoir des SMS qui ne peuvent être lus que par l'utilisateur correspondant.

 Vous ne pouvez utiliser les boîtes à numéros d'appareil différents que si votre opérateur assiste ce service. Veuillez demander le mode d'emploi pour la mise en place de boîtes postales auprès de votre opérateur.

<sup>1</sup> **CLIP** : Calling Line Identification Presentation

<sup>2</sup> **SMS** : Short Message Service



## 10 Plusieurs combinés / bases

### Plusieurs combinés

Par l'intermédiaire du standard **GAP<sup>1</sup> international normé**, les combinés SWITEL ainsi que les combinés d'autres fabricants peuvent être intégrés dans le système téléphonique. De même, vous pouvez déclarer un combiné SWITEL sur des bases d'autres fabricants dans la mesure où ces appareils travaillent d'après le standard GAP.



Pour annuler un combiné d'une base, vous avez dans tous les cas besoin d'un autre combiné déclaré sur cette base. Si vous voulez déclarer des combinés sur une nouvelle base, annulez auparavant ces combinés de l'ancienne base.

### Déclaration de combinés

Vous pouvez déclarer 5 combinés sur votre base. Un numéro d'appel interne est donné automatiquement au combiné après la déclaration. Ce numéro d'appel interne est affiché à l'écran.

#### Déclaration de combinés CD77382 sur des bases CD77382

5 sec

CD77382 Mettre la base en mode d'enregistrement

Déclarez le combiné. page 38

#### Déclaration de combinés CD77382 sur des bases d'autres fabricants

Pour amener la base de l'autre fabricant en mode d'enregistrement, suivez les instructions contenues dans le mode d'emploi de ce dernier. Pour déclarer le combiné, utilisez le code PIN de l'autre fabricant.

Déclarez le combiné. page 38

#### Déclaration de combinés d'autres fabricants sur des bases CD77382

5 sec

Mettre la base en mode d'enregistrement

Pour la déclaration du combiné, suivez les indications du mode d'emploi de l'autre fabricant. Utilisez, pour la déclaration, le code PIN actuellement paramétré (réglage usine : 0000).

### Plusieurs bases

Vos combinés peuvent être simultanément déclarés sur 4 bases différentes. A cet effet, vous pouvez utiliser des bases CD77382 mais aussi des bases d'autres fabricants dans la mesure où ces appareils travaillent d'après le standard **GAP<sup>1</sup>**. Pour cela, chacune des bases nécessite sa propre prise téléphonique. Vous pouvez raccorder les bases à des prises téléphoniques ayant le même numéro, mais également à des raccordements ayant des numéros distincts.

#### Mobilité grâce à différents emplacements

Déclarez votre combiné à différents endroits sur des bases différentes. Le combiné se manifeste automatiquement sur la base la plus proche dans la mesure où vous avez activé la fonction "Choix automatique". page 38

#### Augmentation de la portée

Placez plusieurs bases de telle façon que la portée de chacune des bases se recoupent avec les autres. Testez, le cas échéant, la portée de vos combinés. Des obstacles dans les bâtiments peuvent considérablement limiter la portée.



Les communications en cours ne peuvent pas être transférées d'une base à l'autre.

<sup>1</sup> **GAP: Generic Access Profile** = Standard pour l'action conjointe de combinés et de bases de fabricants différents.

# En cas de problèmes

## 11 En cas de problèmes

Si vous avez des problèmes avec votre téléphone, contrôlez d'abord les remarques suivantes. Si vous avez des droits de garantie, adressez-vous à votre revendeur.

### Questions et réponses

Questions	Réponses
Pas de connexion possible avec la base	<ul style="list-style-type: none"><li>- Contrôlez si vous vous êtes bien identifié sur la base par le code PIN correct. ☞ page 38</li></ul>
Pas de communication téléphonique possible	<ul style="list-style-type: none"><li>- Le câble du téléphone n'est pas correctement branché ou est soumis à des perturbations. N'utilisez que le câble de raccordement téléphonique fourni avec l'appareil.</li><li>- Testez avec un autre téléphone si votre raccordement téléphonique fonctionne.</li><li>- Le bloc d'alimentation n'est pas branché ou il y a une panne totale de courant.</li><li>- Les piles rechargeables sont vides ou défectueuses.</li><li>- Vous vous êtes trop éloigné de la base.</li></ul>
La liaison est hachée, coupée	<ul style="list-style-type: none"><li>- Vous vous êtes trop éloigné de la base.</li><li>- Mauvais lieu d'installation de la base.</li></ul>
Le système ne réagit plus	<ul style="list-style-type: none"><li>- Retirez le bloc d'alimentation de la prise de courant pendant un court instant.</li><li>- Rétablissez les réglages usine. ☞ page 43</li></ul>
Les piles rechargeables sont vides au bout de peu de temps	<ul style="list-style-type: none"><li>- La pile rechargeable est vide ou défectueuse.</li><li>- Placez le combiné correctement sur sa base. Nettoyez les surfaces de contact du combiné et de la base avec un chiffon doux et non pelucheux.</li><li>- Posez le combiné sur la base et laissez-le pendant 14 heures .</li></ul>
L'affichage du numéro d'appel (CLIP) ne fonctionne pas	<ul style="list-style-type: none"><li>- L'affichage du numéro d'appel est un service optionnel de votre exploitant de réseau. Veuillez lui demander de plus amples informations.</li><li>- Le correspondant a bloqué la transmission de son numéro d'appel.</li></ul>
Le répondeur n'enregistre pas d'appels	<ul style="list-style-type: none"><li>- Assurez-vous que celui-ci est correctement connecté et branché.</li><li>- Contrôlez si la mémoire du répondeur est pleine. Supprimez des messages, le cas échéant. ☞ page 34</li></ul>
Vous ne pouvez enregistrer aucun mémo	<ul style="list-style-type: none"><li>- Contrôlez si la mémoire du répondeur est pleine. Supprimez des messages, le cas échéant. ☞ page 34</li></ul>
Vous ne pouvez pas exécuter de consultation à distance	<ul style="list-style-type: none"><li>- Contrôlez si vous utilisez bien le code de sécurité correct pour cette consultation. ☞ page 34</li><li>- Le téléphone que vous voulez utiliser pour la consultation à distance doit être branché sur la numérotation par tonalité.</li></ul>

## 12 Caractéristiques techniques

### Données techniques

Caractéristique	Valeur
Standard	DECT <sup>1</sup> -GAP <sup>2</sup>
Alimentation en courant	Entrée : 220/230 V, 50 Hz Sortie : 8 V, 300 mA / 9 V, 120 mA
Hors portée	A l'extérieur : env. 300 m A l'intérieur : env. 50 m
Etat de veille	Plus que 110 h
Durée max. de communication	Jusqu'à 12 h
Piles rechargeables	2 x 1.2 V, taille : AAA
Numérotation	Numérotation par tonalité
Température ambiante autorisée	10°C à 30°C
Humidité atmosphérique relative autorisée	20% à 75%
Fonction de flash	90 ms, 250 ms

### Restauration des réglages usine

2 sec <input type="button" value="⓪"/>	Débranchement du combiné
<input type="button" value="⓪"/> , attendre 2 sec, <input type="button" value="✳"/>	Brancher le combiné, attendre et déclencher la réinitialisation
<input type="button" value="Réglages usine"/> <input type="button" value="OK"/>	Confirmer la réinitialisation
<input type="button" value="Réglages usine"/> <input type="button" value="Retour"/>	Interrompre la réinitialisation

### Réglages usine

	Paramétrer des SMS
Langue : allemand	
Nom du combiné : CD7738	Entrée : vide
Numéro interne : 1	Sortie : vide
Répertoire : vide (150 places de mémoire)	Centre de service de réception : Swisscom: 0622 100 000
Liste d'appels : vide (50 places de mémoire)	Centre de service de transmission : Swisscom: 0622 100 000
Répétition autom. des derniers numéros : vide (20 places de mémoire)	Tonalité de messages : activée
Prise d'appel autom. : activée	Signal sonore d'avertissement : morse
Volume sonore de la sonnerie d'appel : 3	Utilisateur : "Ajouter boîte perso."
Volume sonore de l'écouteur : 3	N° d'appareil : 0
Mélodie interne : 1	<b>Base</b>
Mélodie ext. de sonnerie d'appel : 5	Temps de flash : 1 (90 ms)
Couleur du menu : bleu	Volume sonore de la base : 3
Alarme : Arrêt	Mélodie de sonnerie de la base : 5
Verrouillage du clavier : arrêt	Code PIN : 0000

<sup>1</sup> DECT: Digitally Enhanced Cordless Telephone = Standard pour téléphones sans fil.

<sup>2</sup> GAP: Generic Access Profile = Standard pour l'action conjointe de combinés et de bases de fabricants différents.

# Caractéristiques techniques

## Réglages usine du répondeur

Annnonce : texte d'annonce 1

Retardement de la prise d'appel :  
6 sonneries d'appel

Mémoire des messages : Vide

Prise d'appel quand le répondeur est débranché :  
20 sonneries d'appel

Code de sécurité : 000

Volume : 5

Répondeur : activé

Jour de la semaine / heure :  
saturday / 12:01 pm (après-midi)

### 13 Remarques d'entretien / Garantie

#### Remarques d'entretien

- Nettoyez les surfaces du boîtier avec un chiffon doux et non pelucheux.
- N'utilisez pas de produits nettoyeurs ou de solvants.

#### Garantie

Les appareils SWITEL sont fabriqués et testés selon les procédés de production les plus modernes. Les matériaux choisis et la haute technologie assure un fonctionnement parfait et une longue durée de vie. La garantie ne rentre pas en jeu si l'exploitant du réseau téléphonique ou une installation à postes supplémentaires éventuellement intercalée est responsable du dysfonctionnement de l'appareil. La garantie ne s'applique pas aux piles rechargeables standard ou aux packs de piles rechargeables utilisés dans le produit. La durée de garantie est de 24 mois à partir de la date d'achat.

Pendant la période de la garantie, tous les défauts dus à des erreurs de matériel et de fabrication sont réparés gratuitement. La garantie expire en cas d'interventions de l'acheteur ou d'un tiers. Les dommages engendrés par une manipulation ou une utilisation inadéquates, par un mauvais emplacement ou rangement, par un raccordement ou une installation inadéquate ainsi que par un cas de force majeure ou d'autres influences extérieures ne sont pas inclus dans la prestation de la garantie. En cas de réclamations, nous nous réservons le droit de réparer ou de remplacer les pièces défectueuses ou d'échanger l'appareil. Les pièces ou appareils échangés deviennent notre propriété. Le droit de réclamer des dédommagements est exclu sauf si ce dommage est basé sur une préméditation ou une négligence grave du fabricant.

Si votre appareil devait cependant comporter un défaut pendant la période de garantie, veuillez vous adresser exclusivement au magasin dans lequel vous avez acheté votre appareil en présentant votre bon d'achat. Tous les droits de garantie basés sur ces dispositions ne peuvent être réclamés qu'auprès de votre revendeur. A l'échéance des deux ans après l'achat et le transfert de nos produits, les législations en matière de garantie ne sont plus applicables.

# Index

## 14 Index

### A

Affichage du numéro d'appel, 36  
Appeler, 31  
Augmentation de la portée, 41

### B

Boîtes postales, 40  
Branchement / débranchement du répondeur, 33  
Branchement à distance du répondeur, 35  
Branchement et débranchement du combiné, 27

### C

Centre de services SMS, 40  
Chargement des piles rechargeables, 27  
Chiffre de la ligne principale, 36  
Code d'accès, 36  
Code de sécurité pour la consultation à distance, 34  
Comment chercher le combiné, 32  
Comment mener des conférences téléphoniques führen, 32  
Comment passer des communications internes, 31  
Comment se servir du téléphone, 29  
Comment téléphoner, 31  
Comment transférer des communications externes à des internes, 31  
Communication interne, 31  
Composition de numéros du répertoire, 31  
Conditions SMS, 40  
Consignes de sécurité, 26  
Consultation à distance, 34  
Contenu de l'emballage, 27  
Créer des enregistrements dans le répertoire, 30

### D

Débranchement du microphone, 32  
Déclaration de combinés, 38, 41  
Données techniques, 43  
Durée d'enregistrement maximale, 33  
Durée de la communication, 32

### E

Economiseur de taxes, 33  
Ecoute de messages / de mémos, 34  
Effacement de messages / de mémos, 34  
Effacement des annonces, 34  
Eléments de manipulation, 28  
Enregistrement d'un mémo, 34  
Enregistrement des annonces, 34

### F

Fin de la communication, 31  
Fonctions des touches, 35

### G

Garantie, 45

### I

Installations à postes supplémentaires, 27, 36  
Intercommunication, 31

### L

Liste des appels, 37

### M

Menu principal, 37  
Mise en place des piles, 27  
Mise en service du téléphone, 27  
Mobilité, 41  
Mode mains-libres, 32

### N

Navigation dans le menu, 30  
Niveau de chargement des piles rechargeables, 27  
Notations, 29  
Numéro d'appareil, 40

### P

Paging, 32  
Pause de numérotation, 36  
Plusieurs bases, 41  
Plusieurs combinés, 41  
Prise d'appel, 31, 33  
Prise d'appel retardée, 33

### Q

Questions et réponses, 42

### R

Raccordement de la base, 27  
Raccordement du chargeur, 27  
Rappel des appels entrés, 31  
Réglage de l'heure et de la date, 27  
Réglage de la date et de l'heure, 38  
Réglage de la langue du répondeur, 33  
Réglage du jour de la semaine et de l'heure du répondeur, 33  
Réglage du volume sonore du répondeur, 33  
Réinitialisation, 43  
Remarques d'entretien, 45  
Répertoire, 39  
Répondeur, 33  
Répondeur dans le réseau téléphonique, 36  
Représentations, 29  
Restauration des réglages usine, 43

### S

Saisie de texte, 40  
Sélection du mode d'annonce, 33  
Services supplémentaires, 36  
SMS, 37, 40  
Structure du menu, 37  
Suppression de tous les messages / mémos, 34  
Symboles à l'écran, 29

### T

Touche de répétition automatique des derniers numéros, 31  
Touche R et services supplémentaires, 36  
Touche R sur les installations à postes supplémentaires, 36  
Touches de navigation, 30

### V

Va-et-vient, 31  
Verrouillage du clavier, 32  
VMWI, 36  
Volume sonore de l'écouteur, 32

1	Indicazioni di sicurezza . . . . .	48
2	Mettere in funzione il telefono . . . . .	49
3	Elementi di comando . . . . .	50
4	Come funziona il mio telefono? . . . . .	51
5	Compiere telefonate . . . . .	53
6	Segreteria telefonica . . . . .	55
7	Impianti telefonici interni / Servizi aggiuntivi . . . . .	58
8	Struttura di menu . . . . .	59
9	SMS . . . . .	62
10	Maggior numero di unità portatili / stazioni base . . . . .	63
11	In presenza di problemi . . . . .	64
12	Specifiche tecniche . . . . .	65
13	Consigli per la cura / Garanzia . . . . .	67
14	Indice . . . . .	68

# Indicazioni di sicurezza

## 1 Indicazioni di sicurezza

Leggere attentamente le presenti istruzioni per l'uso.

### Impiego conforme agli usi previsti

Il presente apparecchio consente di compiere telefonate all'interno di una rete di telecomunicazione. Qualsiasi altro impiego è considerato come non conforme agli usi previsti. Non sono consentite modifiche o trasformazioni non autorizzate. Non aprire per nessuna ragione l'apparecchio autonomamente e svolgere riparazioni di propria iniziativa.

### Luogo di installazione

Evitare un'esposizione a fumo, polvere, vibrazioni, sostanze chimiche, umidità, calore e raggi solari diretti. Non utilizzare l'unità portatile in aree esposte al rischio di deflagrazione.

### Alimentatore di rete



**Attenzione:** Utilizzare esclusivamente l'alimentatore a spina fornito in dotazione visto che altri alimentatori di rete potrebbero addirittura danneggiare il telefono. Non ostacolare il libero accesso all'alimentatore a spina con mobili o altri oggetti simili.

### Batterie ricaricabili



**Attenzione:** Non gettare le batterie ricaricabili nel fuoco, né sommergerle in acqua.

### Caduta di tensione

In caso di caduta di tensione non è possibile impiegare l'unità per telefonare. Si consiglia di ricorrere in caso di emergenza ad un telefono con filo in grado di funzionare anche senza alimentazione elettrica esterna.

### Apparecchiature mediche



**Attenzione:** Evitare di utilizzare il telefono nelle vicinanze di apparecchiature mediche. Non è possibile escludere completamente il rischio di eventuali influssi.

Telefoni **DECT**<sup>1</sup> possono causare un fastidioso ronzio in apparecchi acustici.

### Smaltimento

Sussiste l'obbligo legislativo al corretto smaltimento di beni di consumo. Il simbolo riportato sul telefono e raffigurato qui a lato indica, che apparecchi usati elettrici ed elettronici e batterie esauste non sono da smaltire assieme ai normali rifiuti domestici.

Procedere allo smaltimento di **apparecchi elettrici o elettronici** presso un centro di raccolta incaricato con lo smaltimento conforme.

Consegnare **batterie ricaricabili** per lo smaltimento presso rivenditori al dettaglio di batterie o centri di raccolta che mettono a disposizione appositi contenitori.

Smaltire **confezioni ed imballaggi** in base a quanto indicato dalle norme in vigore a livello locale.



<sup>1</sup> DECT: Digitally Enhanced Cordless Telephone = Standard per telefoni senza cavo.



## 2 Mettere in funzione il telefono

### Indicazioni di sicurezza



**Attenzione:** Prima della messa in funzione, leggere attentamente le indicazioni di sicurezza riportate al capitolo 1.

### Verificare il contenuto della confezione

La confezione contiene:

- una stazione base con alimentatore di rete
- due unità portatili
- una stazione di carica con alimentatore di rete
- un cavo di collegamento telefonico
- quattro batterie ricaricabili
- un manuale di istruzioni per l'uso

### Collegare la stazione base



**Attenzione:** Posizionare la stazione base con una distanza di 1 m da altre apparecchiature elettroniche visto che altrimenti si possono verificare interferenze reciproche.

Procedere al collegamento della stazione base seguendo quanto raffigurato sul disegno. Utilizzare per motivi di sicurezza solo l'alimentatore di rete così come il cavo di collegamento telefonico forniti in dotazione.

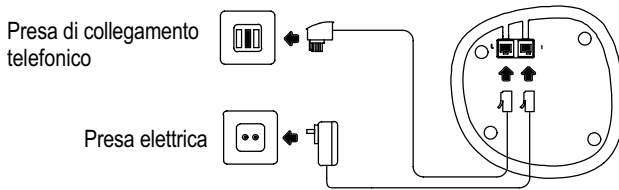

### Collegare la stazione di carica

Procedere al collegamento della stazione di carica seguendo quanto raffigurato sul disegno. Si consiglia di utilizzare per motivi di sicurezza soltanto l'alimentatore fornito in dotazione.

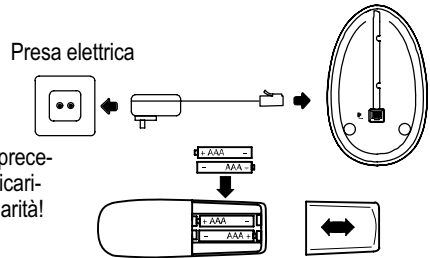

### Inserire le batterie ricaricabili

Inserire le batterie ricaricabili nel rispettivo vano batterie precedentemente aperto. Utilizzare a tale scopo solo batterie ricaricabili del tipo AAA Ni-MH 1,2 V. Osservare la corretta polarità! Chiudere quindi il vano batterie.

### Caricare le batterie

Riporre l'unità portatile in sede di prima messa in funzione per una durata di minimo 14 ore nella stazione base / stazione di carica. Avendo posizionato l'unità portatile nella stazione base / stazione di carica in maniera corretta, la spia di controllo dello stato di carica è accesa. L'unità portatile si surriscalda durante il processo di carica. Questo è un fenomeno normale e non pericoloso. Evitare di caricare l'unità portatile con dispositivi di carica differenti o estranei. Lo **stato di carica delle batterie** attuale è visualizzato sul display:



### Attivare e disattivare l'unità portatile

Allo scopo di risparmiare le batterie standard ricaricabili è possibile disattivare e quindi reinserire l'unità portatile.

2 sec

Disattivare l'unità portatile

Attivare l'unità portatile

### Impostare la data e l'orario

A pagina 60 sono riportate indicazioni relative all'impostazione di data e orario presso l'unità portatile in sede di prima messa in funzione.

### Impianti telefonici interni

A pagina 58 sono riportate ulteriori informazioni in caso si volesse collegare il telefono ad un impianto telefonico interno.

# Elementi di comando

## 3 Elementi di comando

### Unità portatile

- 1 Scorrere verso sopra / Elenco ripetizione di chiamata
- 2 Tasto softkey a destra
- 3 Concludere chiamata / Attivare o disattivare unità portatile
- 4 Blocco tastiera / Chiamate a conferenza
- 5 Chiamate interne
- 6 Tasto R
- 7 Scorrere verso sotto / Chiamate mancate
- 8 Ricevere chiamata / Funzione vivavoce
- 9 Tasto softkey a sinistra

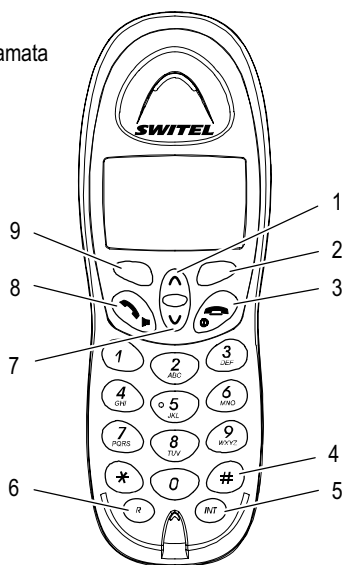

### Stazione base (segreteria telefonica)

- 1 Tasto di ricerca unità portatile (tasto di paging)
- 2 Volume -
- 3 Segreteria telefonica ON / OFF
- 4 Volume +
- 5 Messaggio precedente / Registrare un promemoria
- 6 Arresto
- 7 Riprodurre / Registrare un annuncio
- 8 LED di visualizzazione rete
- 9 Messaggio successivo / Ritardo di accettazione di chiamata
- 10 Cancellare / Codice di sicurezza
- 11 LED di controllo dello stato di carica
- 12 Riproduzione

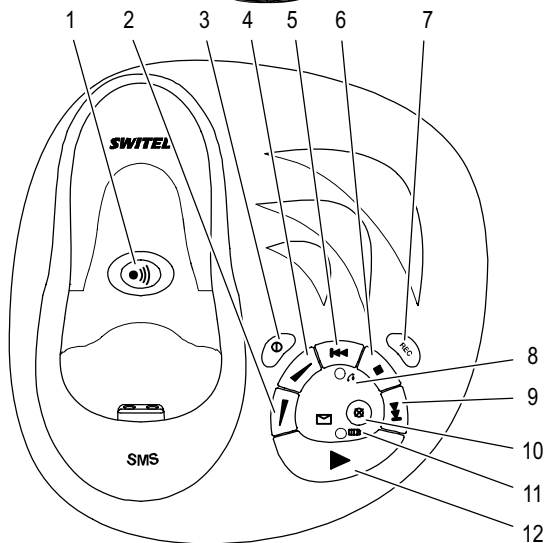

I tasti riportati nelle presenti istruzioni per l'uso sono raffigurati con un bordo uniforme. Con riserva di scostamenti per tasti e simboli visualizzati sul display del telefono rispetto a tasti e simboli di display qui raffigurati.

## 4 Come funziona il mio telefono?

### Rappresentazioni e modi di scrittura

	Immissione di numeri o lettere
	Premere brevemente i tasti raffigurati
2 sec	Premere per 2 secondi il tasto raffigurato
tenere	Tenere premuto il tasto raffigurato
rilasciare	Rilasciare il tasto raffigurato
	Unità portatile squilla
	Stazione base squilla
	Estrarre l'unità portatile dalla stazione base
	Riporre l'unità portatile nella stazione base
Salva in Rubrica	Testo e simboli sul display
Opzioni	Premere il tasto softkey  pagina 52 Tasto di navigazione

### Simboli sul display

Simbolo	Descrizione
	Permanente: Indicazione dello stato di carica delle batterie. Se la spia lampeggia: Caricare le batterie ricaricabili. Segmenti che scorrono: Processo di carica delle batterie in corso.  pagina 49
	La funzione vivavoce è attivata.  pagina 54
	Il blocco tastiera è attivato.  pagina 54
	La "Sveglia" è attivata.  pagina 60
	Nell'elenco chiamate (CLIP) sono memorizzate nuove chiamate.  pagina 58
	Presenza di un nuovo <b>SMS</b> <sup>1</sup> .  pagina 63
	Segreteria telefonica su rete telefonica. <b>VMWI</b> <sup>2</sup> - Servizio opzionale del proprio gestore di rete telefonica  pagina 58
	Permanente: Il collegamento con la stazione base è buono. Se la spia lampeggia: Il collegamento con la stazione base non è buono. Avvicinarsi alla stazione base.
1	Numero di chiamata interno dell'unità portatile  pagina 64
20:22	Visualizzazione dell'orario  pagina 60
SWITEL	Visualizzazione del nome dell'unità portatile  pagina 60

<sup>1</sup> **SMS**: Short Message Service

<sup>2</sup> **VMWI**: Visual Message Waiting Indication

# Come funziona il mio telefono?

## Tasti di navigazione

Tutte le descrizioni riportate nelle presenti istruzioni per l'uso tengono conto dell'unità portatile in stato di stand-by. La modalità di stand-by è selezionata premendo il tasto .



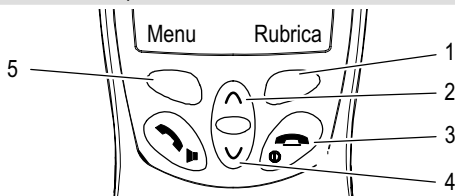





 I tasti softkey (1) e (5) sono programmati con funzioni differenti in base al menu in cui ci si trova. Nelle presenti istruzioni per l'uso questi tasti sono denominati sempre in base ai testi di display visualizzati direttamente al di sopra.



Tasto	In modalità di stand-by	All'interno del menu
1	- Aprire la rubrica telefonica	- Tornare indietro di un livello
2 	- Aprire l'elenco di ripetizione di chiamata	- Per scorrere nei menu - Per modificare le impostazioni
3 	- Attivare o disattivare l'unità portatile	- Interrompere le procedure di programmazione e memorizzazione
4 	- Aprire l'elenco delle chiamate mancate	- Per scorrere nei menu - Per modificare le impostazioni
5	- Aprire il menu principale	- Aprire il menu visualizzato

## Navigare nel menu





I differenti menu consentono di raggiungere tutte le funzioni del telefono. Il percorso da seguire per giungere alla funzione desiderata è indicato dalla struttura di menu.  pagina 59

<b>Menu</b>	Aprire il menu principale
 o 	Selezionare il sottomenu desiderato
<b>OK</b>	Aprire il sottomenu
 o 	Selezionare la funzione desiderata
<b>OK</b>	Aprire la funzione
 o 	Selezionare l'impostazione desiderata
	La tastiera consente di inserire numeri o lettere
<b>OK</b>	Confermare le immissioni
<b>Indietro</b>	Tornare indietro di un livello
	Interrompere le procedure di programmazione e memorizzazione e tornare indietro alla modalità di stand-by

 Ogni singolo processo si interrompe automaticamente se entro 60 secondi non si procede con una immissione.

## Esempio

La procedura da seguire per navigare nei menu e compiere immissioni è indicata con l'esempio "Immettere voci nella rubrica telefonica". Si consiglia di seguire quest'esempio per tutte le altre impostazioni che si desiderano compiere.

<b>Rubrica</b>	Aprire la rubrica telefonica
<b>Opzioni</b> ,  o 	
Salva in Rubrica , <b>OK</b>	Selezionare e confermare la funzione
 , <b>OK</b>	Immettere e confermare il nome
 , <b>OK</b>	Immettere e confermare il numero di chiamata

## 5 Compiere telefonate

### Ricevere una chiamata

 Ricevere una chiamata

### Concludere una chiamata

 o  Concludere una chiamata

### Telefonare

 Immettere un numero di chiamata (max. 25 cifre)

**Cancella** In caso di immissione errata, cancellare l'ultima cifra

 Selezionare un numero di chiamata



E' altresì possibile premere prima il tasto di chiamata e ricevere il segnale di linea libera. Le cifre immesse per la composizione del numero di chiamata desiderato sono immediatamente selezionate. Nel corso di una simile chiamata non è possibile eseguire una correzione di singole cifre che compongono il numero di chiamata.

### Ripetizione di selezione

Il telefono memorizza gli ultimi 20 numeri di chiamata selezionati in un elenco disponibile per la funzione di ripetizione di chiamata.

 Aprire l'elenco di ripetizione di chiamata

 o  Scegliere la voce e instaurare un collegamento

### Riselezionare chiamate ricevute

Il telefono memorizza 20 chiamate mancate nell'elenco chiamate.



 Aprire l'elenco chiamate

 o  Scegliere la voce e instaurare un collegamento

### Selezionare numeri dalla rubrica telefonica

Per fare questo è necessario aver memorizzato i numeri di chiamata nella rubrica telefonica.  pagina 52 e 62

**Rubrica** Aprire la rubrica telefonica

 o  Scegliere la voce e instaurare un collegamento

### Compiere chiamate interne

#### Condurre chiamate interne

Per poter condurre chiamate interne gratuite è necessario aver precedentemente registrato due o più unità portatili (MT1, MT2, ...) ad una stazione base.

MT1: **INT**, per es. **2** Selezionare il numero di chiamata interno dell'unità portatile desiderata

MT2:  Ricevere la chiamata interna presso l'altra unità portatile

MT1 / MT2:  Concludere la chiamata interna

#### Inoltro interno di chiamate esterne

MT1: **INT**, per es. **2** Selezionare il numero di chiamata interno con chiamata esterna in corso

MT2:  Ricevere la chiamata interna presso l'altra unità portatile

MT1:  Trasferire la chiamata



Se l'unità portatile selezionata non dovesse rispondere, la chiamata esterna potrà essere nuovamente ripresa con il tasto **INT**.

#### Riscontro / Chiamata in attesa

Durante lo svolgimento di una chiamata esterna è possibile chiamare un'altra unità portatile allo scopo di consultarsi o eseguire un riscontro. Mentre è in corso la conversazione con l'interlocutore interno, la chiamata esterna è trattenuta. Il numero di passaggi tra i partner di chiamata è illimitato.

MT1: **INT**, per es. **2** Selezionare il numero di chiamata interno con chiamata esterna in corso

MT2:  Ricevere la chiamata interna presso l'altra unità portatile

MT1: **INT** Cambiare il partner di chiamata



## Compiere telefonate

### Compiere chiamate a conferenza

Questa funzione consente di condurre una conferenza con una chiamata esterna ed un altro interlocutore interno.

MT1: **INT**, per es. **2** Selezionare il numero di chiamata interno con chiamata esterna in corso



MT2:  Ricevere la chiamata interna presso l'altra unità portatile

MT1: 2 sec **#** Iniziare la conferenza

MT1 / MT2:  La conferenza è conclusa nel momento in cui uno dei partner di chiamata interni conclude la chiamata

### Impostare il volume del ricevitore

Il volume è regolabile durante lo svolgimento di una chiamata in 5 livelli.

 o  Premere durante la conversazione telefonica

### Visualizzazione della durata di conversazione

Durante lo svolgimento di una chiamata, la durata della telefonata è visualizzata in minuti e secondi sul display.

### Funzione vivavoce

Utilizzare questa funzione per ascoltare il partner di chiamata attraverso l'altoparlante.

  Attivare la funzione vivavoce

 Disattivare la funzione vivavoce

### Silenziamento del microfono nell'unità portatile

E' possibile attivare e disattivare il microfono dell'unità portatile con chiamata telefonica in corso.

**Esc Mic** **Microfono Escluso** Disattivare il microfono (silenziamento)

**Att Mic** Attivare il microfono

### Blocco tastiera

L'attivazione del blocco tastiera consente di ricevere telefonate in arrivo come di consueto.

2 sec   Attivare il blocco tastiera

**Sblocca**, **Si** Disattivare il blocco tastiera

### Ricerca dell'unità portatile (funzione di paging)

Avendo perso d'occhio la propria unità portatile è possibile ritrovarla facilmente grazie all'emissione di un tono di ricerca.

  Avviare il tono di ricerca

 o  Interrompere il tono di ricerca

## 6 Segreteria telefonica



La segreteria telefonica offre all'utente delle istruzioni sotto forma di guida parlata. Osservare pertanto le istruzioni ed indicazioni fornite.

### Impostazione della lingua

La guida di cui dispone la segreteria telefonica è parlata in lingua inglese e non è modificabile.

### Impostare la data e l'orario

Durante la riproduzione dei messaggi, ogni messaggio è accompagnato dall'indicazione di giorno settimanale e orario in cui il messaggio è stato ricevuto.

2 sec	Attivare la modalità di impostazione
o ,	Impostare e confermare il giorno settimanale
o ,	Impostare e confermare le ore
o ,	Impostare e confermare i minuti

### Riprodurre la data e l'orario

	Riproduzione di giorno settimanale e orario impostati
--	---

### Attivare / Disattivare la segreteria telefonica

	Attivare / Disattivare la segreteria telefonica
--	---

### Durata di registrazione massima

La segreteria telefonica è in grado di memorizzare fino a 60 messaggi. La durata di registrazione massima è di 16 minuti. La lunghezza massima di ogni messaggio è di 2 minuti. Se la capacità di memoria è esaurita e la registrazione di nuovi messaggi non è più possibile, non sarà più registrata alcuna chiamata.

### Impostare il volume

E' possibile impostare il volume in 11livelli.

o	Impostare il volume
---	---------------------

### Ritardo di accettazione di chiamata

E' possibile scegliere tra 2 e 9 segnalazioni di chiamata e l'impostazione **Risparmio di addebiti** per compiere un'interrogazione a distanza preliminare gratuita. Con la funzione di interrogazione a distanza preliminare gratuita è possibile verificare la presenza di nuovi messaggi sulla propria segreteria telefonica.

- Se ci sono messaggi nuovi sulla segreteria telefonica, l'apparecchio accetta la telefonata dopo sole 2 segnalazioni di chiamata.
- Se la chiamata non è accettata dopo 4 squilli, non c'è nessun nuovo messaggio. Riagganciare prima del 4° squillo. In questo modo non si verifica alcuna addebito.

tenere	Attivare la modalità di impostazione
rilasciare	Selezionare l'impostazione

Ulteriori informazioni sull'interrogazione a distanza ☞ pagina 56

### Riprendere una chiamata

Anche se la segreteria telefonica ha già risposto ad una chiamata è comunque possibile riprendere la telefonata. Fatto questo, la registrazione del messaggio si interrompe.

o	Riprendere la chiamata
---	------------------------

### Selezionare la modalità annunci

La segreteria telefonica dispone di due annunci predefiniti. Dopo il messaggio di annuncio 1 è possibile lasciare un messaggio. Il messaggio di annuncio 2 è invece solo un annuncio che non consente di lasciare alcun messaggio. Messaggio di annuncio 1 e messaggio di annuncio 2 sono sostituibili da un messaggio di annuncio personalizzato. Non appena la memoria della segreteria telefonica è piena, l'apparecchio riproduce automaticamente il messaggio di annuncio 2.





2 sec <b>REC</b>	Attivare la modalità di impostazione
	Attivare il messaggio di annuncio 1
	Attivare il messaggio di annuncio 2

# Segreteria telefonica

## Registrare, verificare o cancellare degli annunci

### Registrare degli annunci

La lunghezza dell'annuncio personalizzato non deve superare i 40 secondi.

2 sec 	Attivare la modalità di impostazione
tenere 	Avviare la registrazione (messaggio di annuncio 1)
rilasciare 	Concludere la registrazione (messaggio di annuncio 1)
tenere 	Avviare la registrazione (messaggio di annuncio 2)
rilasciare 	Concludere la registrazione (messaggio di annuncio 2)

### Verificare l'annuncio attualmente impostato

	Riprodurre l'annuncio
---	-----------------------

### Cancellare l'annuncio personalizzato e fare ritorno all'annuncio standard

Cancellando l'annuncio personalizzato viene automaticamente riattivato l'annuncio standard.



	Riprodurre l'annuncio
	Cancellare l'annuncio

## Registrare dei promemoria

Un promemoria è un messaggio che è possibile riprodurre e quindi ascoltare allo stesso modo di un messaggio ricevuto.

### Registrare un promemoria





La lunghezza massima prevista per un promemoria è di 2 minuti.

tenere 	Avviare la registrazione
rilasciare 	Concludere la registrazione



## Riprodurre / Cancellare messaggi ricevuti o promemoria registrati

### Riprodurre messaggi / promemoria

I messaggi ricevuti / promemoria registrati sono riprodotti nell'ordine cronologico in cui sono registrati. Il giorno della settimana o l'orario sono indicati prima della riproduzione del rispettivo messaggio o promemoria.



2 sec 	Riprodurre nuovi messaggi / nuovi promemoria
	Riprodurre tutti i messaggi / tutti i promemoria
	Interrompere la riproduzione
	Ripetere il messaggio
	Passare al messaggio successivo

### Cancellare un messaggio / promemoria

	Riprodurre il messaggio / promemoria che si desidera cancellare
	Cancellare il messaggio / promemoria

## Cancellare tutti i messaggi / promemoria

Sono cancellati tutti i messaggi / tutti i promemoria. In questo caso sono altresì cancellati messaggi / promemoria nuovi. Riprodurre tutti i messaggi / tutti i promemoria. Una volta riprodotti e quindi ascoltati tutti i messaggi / tutti i promemoria è possibile cancellare tutti i messaggi / promemoria.





	Riprodurre tutti i messaggi / promemoria
	Cancellare messaggi / promemoria

## L'interrogazione a distanza

E' possibile chiamare la propria segreteria telefonica per ascoltare gli eventuali messaggi registrati e per altresì svolgere altre funzioni. Per poter usufruire di queste funzioni è necessario compiere le chiamate da un telefono con procedura di selezione a toni.

### Codice di sicurezza per l'interrogazione a distanza

Per poter eseguire l'interrogazione a distanza è necessario immettere il codice di sicurezza. Questo è impostato in fabbrica e corrisponde a "000".

2 sec 	Attivare la modalità di impostazione
 o  , 	1. Modificare e confermare il numero
 o  , 	2. Modificare e confermare il numero
 o  , 	3. Modificare e confermare il numero



## Avviare l'interrogazione a distanza



Selezionare il proprio numero di chiamata



Premere durante la riproduzione dell'annuncio e immettere il codice di sicurezza



In caso di immissione errata, l'annuncio della segreteria telefonica è nuovamente riprodotto. In seguito all'immissione errata del codice di sicurezza per tre volte, il collegamento è interrotto automaticamente.

A questo punto è possibile svolgere altre funzioni. ➔ [Panoramica delle funzioni a tasti](#)

## Attivazione a distanza della segreteria telefonica



Selezionare il proprio numero di chiamata



Nel caso in cui si fosse dimenticato di inserire la propria segreteria telefonica, l'apparecchio risponderà alla chiamata solo dopo 20 segnalazioni di chiamata.



Premere dopo aver sentito il segnale acustico e immettere il codice di sicurezza

**7**

Attivare / Disattivare la segreteria telefonica

A questo punto è possibile svolgere altre funzioni. ➔ [Panoramica delle funzioni a tasti](#)

## Funzioni a tasti dell'interrogazione a distanza



L'interrogazione a distanza è interrotta automaticamente se entro 10 secondi non si procede con una immissione.

Le funzioni a tasti dipendono dal menu in cui ci si trova. La seguente tabella offre una panoramica delle singole funzioni a tasti.

Tasto	<b>1</b> Funzioni nel menu principale	<b>8</b> Funzioni nel menu annunci
<b>1</b>	Riprodurre di nuovo il menu principale	<b>Aprire e riprodurre il menu principale</b>
<b>2</b>	Riprodurre tutti i messaggi	Riprodurre il messaggio di annuncio impostato
<b>3</b>	Riprodurre solo i messaggi nuovi	Registrare il messaggio di annuncio 1 ➔ pagina 56
<b>4</b>	Riprodurre nuovamente il messaggio in corso	Registrare il messaggio di annuncio 2 ➔ pagina 56
<b>5</b>	- Cancellare il messaggio in corso - Cancellare tutti i messaggi (dopo aver ascoltato tutti i messaggi / promemoria)	- Attivare il messaggio di annuncio 1 ➔ pagina 56 - Cancellare il messaggio di annuncio 1 o 2 (riproduce il messaggio di annuncio che è cancellato durante la riproduzione)
<b>6</b>	Riprodurre il messaggio successivo	Attivare il messaggio di annuncio 2 ➔ pagina 56
<b>7</b>	Attivare / Disattivare la segreteria telefonica	
<b>8</b>	<b>Aprire e riprodurre il menu annunci</b>	Riprodurre di nuovo il menu annunci
<b>9</b>	Impostare il codice di sicurezza <b>Attivare la modalità di impostazione:</b> * <b>Impostare il codice di sicurezza:</b> per es. "000" = 0, 0, 0 <b>Confermare l'impostazione:</b> #	
<b>0</b>	Impostare la data e l'orario <b>Attivare la modalità di impostazione:</b> * <b>Impostare il giorno settimanale:</b> Lunedì = 1, martedì = 2, mercoledì = 3, giovedì = 4, venerdì = 5, sabato = 6, domenica = 7 <b>Impostare l'orario:</b> per es. ore 10.15 = 1, 0, 1, 5 <b>Confermare le impostazioni:</b> #	
*	Attivare la modalità di impostazione	
#	Confermare l'impostazione	Concludere la registrazione
	Riagganciando il telefono la funzione di interrogazione a distanza è conclusa.	

# Impianti telefonici interni / Servizi aggiuntionali

## 7 Impianti telefonici interni / Servizi aggiuntionali

### Tasto R in impianti telefonici interni

Avendo collegato il telefono ad un impianto telefonico interno, il **tasto R** consente di accedere a tutte le altre funzioni disponibili come per es. trasferimento di chiamata e funzione di richiamata automatica. Si prega di consultare le istruzioni per l'uso del proprio impianto telefonico interno per individuare il tempo flash da impostare per poter usufruire di queste funzioni. Il rivenditore specializzato è in grado di indicare se il telefono acquistato funzionerà senza alcun problema nel proprio impianto telefonico interno. Impostare il tempo flash  pagina 60

### Codice di accesso (cifra per il segnale dalla centrale)

In presenza di impianti telefonici interni è necessario preselezionare un numero di accesso alla rete esterna per ottenere un segnale di linea libera prima di poter compiere una telefonata. Se nella propria unità portatile è stata precedentemente memorizzata e attivata una cifra per il segnale dalla centrale, questa cifra per il segnale dalla centrale è selezionata e preposta automaticamente ai numeri di chiamata tratti dalla rubrica telefonica e dagli elenchi chiamate.

### Pausa di selezione

In presenza di impianti telefonici interni è necessario preselezionare un numero di accesso alla rete esterna per ottenere un segnale di linea libera prima di poter compiere una telefonata. Alcuni impianti telefonici interni di vecchia data richiedono un intervallo di tempo di poco superiore prima di trasmettere un segnale di libero. In particolare, proprio per questi impianti telefonici interni è possibile prevedere, dopo aver inserito il numero di accesso alla rete esterna, una pausa di selezione che consente di comporre il numero di chiamata desiderato senza dover necessariamente attendere il segnale di libero.

2 sec 

Inserire la pausa di selezione

Dopo il numero di accesso alla rete esterna il telefono aspetta 3 secondi prima di procedere con la selezione del numero che si desidera chiamare.



La pausa è anche programmabile in sede di immissione dei numeri di chiamata nella rubrica telefonica.

### Tasto R e servizi aggiuntionali

Il telefono supporta servizi aggiuntionali messi a disposizione dal proprio gestore di rete telefonica come per es. le funzioni di chiamata in attesa, avviso di chiamata e chiamata in conferenza. Con il **tasto R** è possibile accedere a questi servizi aggiuntionali. Si prega di consultare il proprio gestore di rete telefonica per ottenere informazioni sul tempo flash necessario per l'utilizzo dei servizi aggiuntionali. Rivolgersi al proprio gestore di rete telefonica per ottenere l'abilitazione ai servizi aggiuntionali. Impostare il tempo flash  pagina 60

### Segreteria telefonica integrata nella rete telefonica

Nel caso in cui il proprio gestore di rete telefonica offra una segreteria telefonica integrata nella rete telefonica, sull'apparecchio appare il simbolo (**VMWI**<sup>1</sup>) indicante la presenza di nuovi messaggi. La segreteria telefonica e l'indicazione sulla presenza di nuovi messaggi mediante simboli sono servizi opzionali offerti dal proprio gestore di rete telefonica. Tali funzioni saranno peraltro solo accessibili nel caso in cui il gestore di rete telefonica offra i servizi descritti. Per maggiori dettagli a riguardo, rivolgersi al proprio gestore di rete telefonica.

### Visualizzazione del numero di chiamata (CLIP<sup>2</sup>)

A condizione che il collegamento telefonico disponga di questa funzione, l'apparecchio visualizza il numero telefonico del chiamante non appena il telefono squilla. Nel caso in cui il chiamante abbia soppresso la trasmissione del proprio numero di chiamata, appare un'apposita indicazione. Visto che il numero di chiamata non è visualizzabile, questo non sarà memorizzato nell'elenco chiamate.



La visualizzazione del numero di chiamata è un servizio opzionale offerto dal proprio gestore di rete telefonica. Si consiglia di rivolgersi al proprio gestore di rete telefonica per ricevere ulteriori informazioni a riguardo.

<sup>1</sup> **VMWI**: Visual Message Waiting Indication

<sup>2</sup> **CLIP**: Calling Line Identification Presentation

## 8 Struttura di menu

### Menu principale

Nel menu principale si giunge premendo il tasto softkey **Menu**.

SMS <sup>1</sup>	Scrivi Messaggio	Opzioni	Invia a	Ricerca
			Salva	
			Inserisci Simbolo	
			Nome Utilizzatore	Impost. d'utente
				Nome Utilizzatore 1-4
				Password
	Ricevuti	Leggi	Opzioni	Rispondi
				Inoltra
				Cancella
	Propri	Leggi	Opzioni	Modifica
	Cancella Messaggi	Ricevuti		Invia a
		Propri		Cancella
		Cancella Tutti		Nome Utilizzatore
	Impostazioni	Centro Servizi	Centro Servizio 1	Centro Servizio 1
			Centro Servizio 2	Centro Servizio 2
		NR. Terminale	NR. Terminale	
		Tono di Avviso	Attiva/Disattiva	
			Imposta	Morse
				Discreto
				Polifonico
		Nome Utilizzatore	Cancella Utiliz.	Nome Utilizzatore 1-4
			Aggiungi Utiliz.	Nome Utilizzatore
			Password	Conferma

Lista Chiamate <sup>2</sup>	Ricevute	Opzioni	Cancella
			Visualizza Numero
			Inserisci Nuovo
	Chiamata senza Resp.	Opzioni	Cancella
			Visualizza Numero
			Inserisci Nuovo
	Effettuate	Opzioni	Cancella
			Visualizza Numero
			Inserisci Nuovo
	Cancella Lista	Ricevute	
		Chiamata senza Resp.	
		Effettuate	
		Tutte le chiamate	

<sup>1</sup> Ulteriori informazioni su messaggi di testo SMS pagina 62

<sup>2</sup> Per visualizzare e memorizzare numeri di chiamata in elenchi chiamate è necessaria la visualizzazione del numero di chiamata (**CLIP**<sup>3</sup>). La visualizzazione del numero di chiamata è un servizio opzionale offerto dal proprio gestore di rete telefonica. Si consiglia di rivolgersi al proprio gestore di rete telefonica per ricevere ulteriori informazioni a riguardo. Ulteriori informazioni sulla visualizzazione del numero di chiamata pagina 58

<sup>3</sup> **CLIP**: Calling Line Identification Presentation

## Struttura di menu

Imposta Portatile	Melodia	Chiamate Esterne	Melodia Base 1-5
		Chiamate Interne	Melodia Base 1-5
	Volume	Volume 1-5 / Disattiva	
	Nome Portatile	Nome	
	Lingua <sup>1</sup>	Lingua1-7	
	Colore Menu	Blu	
		Verde	
		Rosa	
	Risposta Automatica <sup>2</sup>	Attiva/Disattiva	
	Codice di Accesso <sup>3</sup>	Attiva/Disattiva	
		Imposta Codice	

Imposta Base	Suoneria	Melodia Base 1-5		
	Volume Suoneria	Volume Suoneria 1-5 / Disattiva		
	Priorità Portatile <sup>4</sup>	Tutti i Portatili		
		Seleziona Portatile	Portatile 1-5	Squilli 2
				Squilli 4
	Segnale Flash	Flash 1 (100ms)		Squilli 6
		Flash 2 (300ms)		
	Codice PIN <sup>5</sup>	Inser. Vecchio PIN:	Inserisci Nuovo PIN:	
			Conferma Nuovo PIN:	

Orologio	Sveglia	Attiva/Disattiva	Singola	Orologio (24 Ore):
			Quotidiana	Orologio (24 Ore):
			Disattiva	
		Imposta Tono Sveglia	Tono di Sveglia 1-4	
	Imposta Data e Ora	Data:	Orologio (24 Ore):	

Affiliazione	Registra Portatile	Base 1-4	Codice PIN <sup>5</sup>
	Seleziona Base	Automatico	
		Base 1-4	
	Disattiva Portatile	Codice PIN <sup>5</sup>	Portatile 1-5

<sup>1</sup> Lingue: Inglese, francese, tedesco, italiano, spagnolo, olandese e portoghese.

<sup>2</sup> L'attivazione di questa funzione consente di ricevere automaticamente una chiamata in arrivo estraendo semplicemente l'unità portatile dalla stazione base.





<sup>3</sup> Ulteriori informazioni sugli impianti telefonici interni capitolo 7.

<sup>4</sup> Qui è possibile impostare se una chiamata in arrivo dovrà essere segnalata presso tutte le unità portatili selezionate all'interno dell'impianto telefonico o se invece dovrà squillare solo una determinata unità portatile.

<sup>5</sup> Impostazione di default PIN di sistema: 0000

## Rubrica telefonica

Nella rubrica telefonica si giunge premendo il tasto softkey **Rubrica**.

Voce 1	Opzioni	Inserisci Nuovo	 Nome 1	 Numero:
Voce 2		Visualizza Numero		
Voce ...		Cancella		
		Modifica	 Nome 1	 Numero:
		Melodia <sup>2</sup>	Disattiva	
			Melodia Base 1-5	
		Cancella Rubrica		

<sup>1</sup> I tasti numerici riportano altresì delle lettere. Premendo ripetutamente il relativo tasto, si ha modo di selezionare lettere, cifre e caratteri speciali.

<sup>2</sup> Possibilità di assegnare una determinata melodia di suoneria ad una voce dell'elenco telefonico. In presenza di una chiamata da parte di un determinato interlocutore l'unità portatile risponde con la melodia di suoneria impostata. Per questa funzione è necessaria la visualizzazione del numero di chiamata (**CLIP**<sup>3</sup>). La visualizzazione del numero di chiamata è un servizio opzionale offerto dal proprio gestore di rete telefonica. Si consiglia di rivolgersi al proprio gestore di rete telefonica per ricevere maggiori informazioni a riguardo.

<sup>3</sup> **CLIP**: Calling Line Identification Presentation

## 9 SMS

### Requisiti SMS

L'allacciamento telefonico deve disporre della caratteristica funzionale **CLIP**<sup>1</sup>. Assicurarsi presso il proprio gestore di rete telefonica, che l'allacciamento telefonico sia abilitato alla caratteristica funzionale richiesta. Per poter usufruire del servizio **SMS**<sup>2</sup> può rendersi necessaria la precedente abilitazione al servizio presso il proprio gestore di rete telefonica.

- L'invio di SMS non è possibile in impianti di derivazione.
- In caso di collegamenti in call by call, l'invio di un SMS al momento non è ancora possibile.
- L'invio di messaggi SMS è soggetto a costi supplementari.
- Se il ricevitore non utilizza un servizio SMS o se il rispettivo telefono non è abilitato alla ricezione di SMS, il messaggio SMS è inoltrato sotto forma di messaggio vocale.
- Il calcolo delle rispettive spese avviene da parte del proprio gestore di rete telefonica.

### Centro di servizi SMS

La distribuzione di messaggi SMS avviene attraverso un centro di servizi. Per inviare messaggi di testo SMS è necessario programmare il numero del centro di servizi nella propria unità portatile (☞ pagina 59). Si prega di richiedere presso l'offerente scelto il numero del centro di servizi necessario e la procedura da seguire per l'abilitazione al servizio SMS.

 Il presente telefono è già predisposto per l'invio di messaggi di testo SMS. Nell'unità portatile sono stati infatti già programmati i numeri del centro di servizi.

Centro di servizi per ricezione

Swisscom: 0622 100 000

Centro di servizi per invio

Swisscom: 0622 100 000

### Immissione del testo

L'immissione di testo viene eseguita utilizzando le lettere indicate sui tasti numerici del telefono. Premendo ripetutamente il relativo tasto, si ha modo di selezionare lettere, cifre e caratteri speciali.

**1**

Inserire spazi vuoti e segni speciali

**INT**

Cambi fra maiuscolo e minuscolo

**Cancella**

Cancellare l'ultima posizione

2 sec

**Cancella**

Cancellare tutto e tornare indietro nella modalità di stand-by

### Numero di apparecchio

In presenza di un maggior numero di telefoni abilitati al servizio SMS e collegati al proprio allacciamento telefonico, ogni telefono è identificato da un numero di apparecchio. In modo da poter inviare un SMS ad un determinato telefono, il mittente del messaggio di testo SMS deve conoscere il numero di apparecchio del rispettivo telefono da aggiungere al numero di chiamata consueto.

### Caselle postali

Accanto ad una casella postale generale preesistente con numero di apparecchio "0" è possibile impostare e proteggere con password quattro ulteriori caselle postali private. Ogni casella postale è contraddistinta da un nome utente e da un numero di apparecchio. Questa funzione consente di ricevere messaggi SMS destinati esclusivamente da un unico e specifico utente.

 Caselle postali con numeri di apparecchio differenti sono disponibili solo se messe a disposizione dal proprio gestore di rete telefonica. Si prega di rivolgersi al proprio gestore di rete telefonica per ottenere le istruzioni necessarie alla creazione di caselle postali.

<sup>1</sup> **CLIP**: Calling Line Identification Presentation

<sup>2</sup> **SMS**: Short Message Service

## 10 Maggior numero di unità portatili / stazioni base

### Maggior numero di unità portatili

La funzione standard internazionale **GAP**<sup>1</sup> consente l'integrazione sia di unità portatili SWITEL sia di unità portatili di altri costruttori nel sistema telefonico preesistente. Allo stesso modo è possibile selezionare unità portatili SWITEL per stazioni base di altri costruttori, a condizione che gli apparecchi dispongano della funzione GAP standard.



Per deselezionare un'unità portatile da una stazione base è in ogni caso necessario servirsi di un'altra unità portatile registrata presso la stazione base in questione. Volendo registrare le unità portatili presso una nuova stazione base bisogna prima deselezionare queste unità portatili dalla vecchia stazione base ovvero dalla stazione base dove attualmente risultano ancora registrati.

### Registrazione di unità portatili

E' possibile registrare 5 unità portatili presso la stazione base. Una volta eseguita la selezione, all'unità portatile è assegnato un numero di chiamata interno. Questo numero di chiamata interno è visualizzato sul display.

#### Registrazione di unità portatili del tipo CD77382 presso stazioni base del tipo CD77382

5 sec

CD77382 Passare con la stazione base alla modalità di registrazione

Registrare l'unità portatile. ➔ pagina 60

#### Registrazione di unità portatili del tipo CD77382 presso stazioni base di altri costruttori

Per selezionare la modalità di registrazione presso la stazione base di un altro costruttore, seguire le indicazioni riportate nel manuale di istruzioni per l'uso del rispettivo costruttore. Immettere per la selezione il codice PIN dell'altro costruttore

Registrare l'unità portatile. ➔ pagina 60

#### Registrazione di unità portatili di altri costruttori presso stazioni base del tipo CD77382

5 sec

Passare con la stazione base alla modalità di registrazione

Per registrare l'unità portatile seguire le indicazioni riportate nelle istruzioni per l'uso dell'altro costruttore. Immettere per la registrazione il codice PIN attualmente impostato (impostazione di default: 0000).

### Maggior numero di stazioni base

E' possibile registrare le proprie unità portatili presso 4 stazioni base diverse. La funzione è disponibile presso stazioni base del tipo CD77382 come anche presso stazioni base di altri costruttori a condizione che questi apparecchi operino sulla base dello standard **GAP**<sup>1</sup>. Per ogni stazione base è inoltre necessario prevedere una presa telefonica autonoma. Le stazioni base possono essere collegate sia a prese telefoniche aventi lo stesso numero di chiamata sia ad allacciamenti con numeri di chiamata differenti.

#### Mobilità grazie a luoghi di ubicazione differenti

Per fare ciò è sufficiente registrare l'unità portatile in uso in ubicazioni diverse presso stazioni base differenti. Avendo precedentemente selezionato infatti la funzione "selezione automatica", l'unità portatile si registra automaticamente presso la stazione base più vicina. ➔ pagina 60

#### Aumento della portata

Posizionare le diverse stazioni base in modo da ottenere una transizione della portata delle singole stazioni base. Verificare se necessario la portata delle unità portatili utilizzate. Eventuali ostacoli presenti all'interno degli edifici possono notevolmente limitare la portata.



Per chiamate in corso non è invece possibile compiere un trasferimento da una stazione base all'altra.

<sup>1</sup> **GAP**: **Generic Access Profile** = Standard per l'interazione di unità portatili con stazioni base di altri costruttori.

# In presenza di problemi

## 11 In presenza di problemi

In presenza di problemi con il telefono, seguire le indicazioni riportate qui di seguito. In caso di reclami entro il periodo di garanzia, rivolgersi al rivenditore autorizzato.

### Domande e risposte

Domande	Risposte
Non è possibile collegarsi alla stazione base.	<ul style="list-style-type: none"><li>- Verificare se la registrazione alla stazione base è stata eseguita con il codice PIN corretto. ☞ pagina 60</li></ul>
Non è possibile condurre una chiamata telefonica.	<ul style="list-style-type: none"><li>- La linea telefonica non è collegata correttamente oppure presenta un guasto. Utilizzare esclusivamente il cavo di collegamento telefonico fornito.</li><li>- Provare con un altro telefono se l'allacciamento telefonico in questione è funzionante.</li><li>- L'alimentatore di rete non è inserito oppure si è in presenza di una caduta di tensione totale.</li><li>- Le batterie ricaricabili sono scariche o difettose.</li><li>- La distanza dalla stazione base è troppo grande.</li></ul>
Collegamento disturbato, si interrompe.	<ul style="list-style-type: none"><li>- La distanza dalla stazione base è troppo grande.</li><li>- Luogo di installazione della stazione base errato.</li></ul>
Il sistema non reagisce più.	<ul style="list-style-type: none"><li>- Estrarre brevemente l'alimentatore di rete dalla presa di corrente.</li><li>- Ripristinare le impostazioni di default. ☞ pagina 65</li></ul>
Le batterie ricaricabili si scaricano piuttosto subito.	<ul style="list-style-type: none"><li>- Le batterie sono scariche o difettose.</li><li>- Riporre l'unità portatile correttamente nella stazione base. Pulire le superfici di contatto di unità portatile e stazione base con un panno morbido e asciutto.</li><li>- Posizionare l'unità portatile per la durata di 14 ore nella stazione base.</li></ul>
La visualizzazione del numero di chiamata (CLIP) non funziona.	<ul style="list-style-type: none"><li>- La visualizzazione del numero di chiamata è un servizio opzionale offerto dal proprio gestore di rete telefonica. Per maggiori dettagli a riguardo, rivolgersi al proprio gestore di rete telefonica.</li><li>- Il chiamante ha disattivato la trasmissione del proprio numero di chiamata.</li></ul>
La segreteria telefonica non registra più alcuna chiamata.	<ul style="list-style-type: none"><li>- Assicurarsi che la segreteria telefonica sia collegata e attivata correttamente.</li><li>- Verificare che la memoria della segreteria telefonica non sia piena. Cancellare eventualmente dei messaggi dalla memoria. ☞ pagina 56</li></ul>
Non è possibile registrare un promemoria.	<ul style="list-style-type: none"><li>- Verificare che la memoria della segreteria telefonica non sia piena. Cancellare eventualmente dei messaggi dalla memoria. ☞ pagina 56</li></ul>
Non è possibile compiere un'interrogazione a distanza.	<ul style="list-style-type: none"><li>- Verificare se è stato utilizzato il codice di sicurezza corretto per l'interrogazione a distanza. ☞ pagina 56</li><li>- Il telefono utilizzato per l'interrogazione a distanza deve essere impostato per la selezione a toni.</li></ul>



## 12 Specifiche tecniche

### Specifiche tecniche

Caratteristica	Valore
Standard	<b>DECT<sup>1</sup>-GAP<sup>2</sup></b>
Alimentazione elettrica	Ingresso: 220/230 V, 50 Hz Uscita: 8 V, 300 mA / 9 V, 120 mA
Portata	in campo aperto: ca. 300 m in ambienti interni: ca. 50 m
Autonomia di stand-by	più di 110 ore
Autonomia di chiamata	fino a 12 ore
Batterie ricaricabili	2 x 1.2 V, tipo: AAA
Procedura di selezione	Procedura di selezione a toni
Temperatura ambiente consentita	10°C fino 30°C
Umidità atmosferica relativa consentita	da 20% a 75%
Funzione flash	90 ms, 250 ms

### Ripristinare le impostazioni di default

2 sec <input type="button" value="⓪"/>	Disattivare l'unità portatile
<input type="button" value="⓪"/> , attendere 2 sec., <input type="button" value="✳️"/>	Inserire l'unità portatile, attendere e avviare il ripristino
<input type="button" value="Impost. di fabbrica"/> <input type="button" value="OK"/>	Confermare il ripristino
<input type="button" value="Impost. di fabbrica"/> <input type="button" value="Indietro"/>	Interrompere il ripristino

### Impostazioni di default

	Impostazioni SMS
Lingua: Tedesco	
Nome unità portatile: CD7738	Ingresso: vuoto
Numero di chiamata interno: 1	Uscita: vuoto
Rubrica telefonica: vuoto (150 posizioni di memoria)	Centro di servizi per ricezione: Swisscom: 0622 100 000
Elenco chiamate: vuoto (50 posizioni di memoria)	Centro di servizi per invio: Swisscom: 0622 100 000
Ripetizione di chiamata: vuoto (20 posizioni di memoria)	Suono messaggi: ON
Messaggio di annuncio automatico: ON	Suono di avviso: Tono morse
Volume della segnalazione di chiamata: 3	Utente: "Aggiungi Utiliz"
Volume del ricevitore: 3	Numero di apparecchio: 0
Melodia di suoneria interna: 1	<b>Stazione base</b>
Melodia di suoneria esterna: 5	Tempo flash: 1 (90 ms)
Colore di menu: Blu	Volume stazione base: 3
Sveglia: OFF	Melodia di suoneria stazione base: 5
Blocco tastiera: OFF	Codice PIN: 0000

<sup>1</sup> **DECT**: Digitally Enhanced Cordless Telephone = Standard per telefoni senza cavo.

<sup>2</sup> **GAP**: Generic Access Profile = Standard per l'interazione di unità portatili con stazioni base di altri costruttori.

## Specifiche tecniche

### Impostazioni di default della segreteria telefonica

Annuncio: Messaggio di annuncio 1	Ritardo dell'accettazione di chiamata: 6 segnalazioni di chiamata
Memoria di messaggi: vuoto	Ricezione con segreteria telefonica disattivata: 20 segnalazioni di chiamata
Codice di sicurezza: 000	Volume: 5
Segreteria telefonica: ON	Giorno settimanale / Orario: Saturday / 12:01 pm (pomeridiano)

### 13 Consigli per la cura / Garanzia

#### Consigli per la cura

- Pulire le superfici degli apparecchi con un panno morbido e antipilling.
- Non utilizzare mai detersivi o solventi.

#### Garanzia

Gli apparecchi SWITEL sono costruiti e collaudati in osservanza dei processi di produzione più moderni. L'impiego di materiali selezionati e tecnologie altamente sviluppate garantiscono un perfetto funzionamento ed una lunga durata in vita. Non è possibile richiamarsi alla presente garanzia nel caso in cui la causa per il malfunzionamento dell'apparecchio risalga al gestore della rete telefonica o ad un eventuale impianto telefonico interno interposto. La garanzia non si estende alle batterie standard o compatte ricaricabili utilizzate all'interno degli apparecchi. Il periodo di garanzia ricopre 24 mesi a partire dalla data di acquisto.

Entro il periodo di garanzia sarà eliminato gratuitamente qualsiasi guasto relativo a difetti di materiale o di produzione. La garanzia rilasciata cessa in caso di intervento da parte dell'acquirente o di terze persone. La presente garanzia non ricopre danni dovuti all'uso o all'esercizio non conforme a quanto previsto, ad un errato montaggio o conservazione, a collegamento o installazione impropri così come a forza maggiore o a qualsiasi altro influsso esterno. In qualità di produttore ci riserviamo il diritto, in caso di reclami, di riparare o sostituire le parti difettose o di rimpiazzare l'apparecchio. Parti sostituite o apparecchi rimpiazzati divengono di nostra proprietà. Si escludono richieste di risarcimento danni, qualora non fondate su intenzione o colpa grave da parte del costruttore.

Nel caso in cui il presente apparecchio dovesse ciò nonostante presentare un difetto durante il periodo di garanzia, si prega di rivolgersi esclusivamente al negozio di rivendita dell'apparecchio SWITEL assieme al relativo scontrino di acquisto. In base alle presenti disposizioni, tutti i diritti di garanzia dovranno essere fatti valere esclusivamente nei confronti del rivenditore autorizzato. A decorrere da due anni dalla data di acquisto e consegna dei nostri prodotti non sarà più possibile fare valere eventuali diritti a garanzia.

# Indice

## 14 Indice

### A

- Attivare / Disattivare la segreteria telefonica, 55
- Attivare e disattivare l'unità portatile, 49
- Attivazione a distanza della segreteria telefonica, 57
- Aumento della portata, 63

### B

- Blocco tastiera, 54

### C

- Cancellare degli annunci, 56
- Cancellare messaggi / promemoria, 56
- Cancellare tutti i messaggi / promemoria, 56
- Caricare le batterie, 49
- Caselle postali, 62
- Centro di servizi SMS, 62
- Chiamata in attesa, 53
- Cifra per il segnale dalla centrale, 58
- Codice di accesso, 58
- Codice di sicurezza per l'interrogazione a distanza, 56
- Collegare la stazione base, 49
- Collegare la stazione di carica, 49
- Come funziona il mio telefono?, 51
- Compiere chiamate a conferenza, 54
- Compiere chiamate interne, 53
- Compiere telefonate, 53
- Concludere una chiamata, 53
- Condurre chiamate interne, 53
- Consigli per la cura, 67
- Contenuto della confezione, 49

### D

- Domande e risposte, 64
- Durata di conversazione, 54
- Durata di registrazione massima, 55

### E

- Elementi di comando, 50
- Elenchi chiamate, 59

### F

- Funzione vivavoce, 54
- Funzioni a tasti, 57

### G

- Garanzia, 67

### I

- Immettere voci nella rubrica telefonica, 52
- Immissione del testo, 62
- Impianti telefonici interni, 49, 58
- Impostare il volume della segreteria telefonica, 55
- Impostare la data e l'orario, 60
- Impostare la data e l'orario, 49
- Impostare la data e l'orario della segreteria telefonica, 55
- Impostare la lingua della segreteria telefonica, 55
- Indicazioni di sicurezza, 48
- Inoltro interno di chiamate esterne, 53
- Inserire le batterie ricaricabili, 49
- Interrogazione a distanza, 56

### M

- Maggior numero di stazioni base, 63
- Maggior numero di unità portatili, 63
- Menu principale, 59
- Mettere in funzione il telefono, 49
- Mobilità, 63
- Modi di scrittura, 51

### N

- Navigare nel menu, 52
- Numero di apparecchio, 62

### P

- Paging, 54
- Pausa di selezione, 58

### R

- Rappresentazioni, 51
- Registrare degli annunci, 56
- Registrare dei promemoria, 56
- Registrare unità portatili, 60
- Registrazione di unità portatili, 63
- Requisiti SMS, 62
- Ricerca dell'unità portatile, 54
- Ricevere una chiamata, 53
- Ripetizione di selezione, 53
- Riprendere una chiamata, 55
- Ripristinare le impostazioni di default, 65
- Ripristino, 65
- Riprodurre messaggi / promemoria, 56
- Riscontro, 53
- Riselezionare chiamate ricevute, 53
- Risparmio di addebiti, 55
- Ritardo di accettazione di chiamata, 55
- Rubrica telefonica, 61

### S

- Segreteria telefonica, 55
- Segreteria telefonica integrata nella rete telefonica, 58
- Selezionare la modalità annunci, 55
- Selezionare numeri dalla rubrica telefonica, 53
- Servizi aggiuntivi, 58
- Silenziamento del microfono, 54
- Simboli sul display, 51
- SMS, 59, 62
- Specifiche tecniche, 65
- Stato di carica delle batterie, 49
- Struttura di menu, 59

### T

- Tasti di navigazione, 52
- Tasto R e servizi aggiuntivi, 58
- Tasto R in impianti telefonici interni, 58
- Telefonare, 53

### V

- Visualizzazione del numero di chiamata, 58
- VMWI, 58
- Volume del ricevitore, 54

1	Safety Information . . . . .	70
2	Putting the Telephone into Operation . . . . .	71
3	Operating Elements . . . . .	72
4	How to Operate the Telephone . . . . .	73
5	Telephoning . . . . .	75
6	Answering Machine . . . . .	77
7	PABX / Supplementary Services . . . . .	80
8	Menu Structure . . . . .	81
9	SMS . . . . .	84
10	Multiple Handsets / Base Stations . . . . .	85
11	In Case of Problems . . . . .	86
12	Technical Properties . . . . .	87
13	Maintenance / Guarantee . . . . .	89
14	Index . . . . .	90

# Safety Information

## 1 Safety Information

Please read this operating instruction manual thoroughly.

### Intended use

The telephone is suitable for telephoning within a public telephone network system. Any other use is considered unintended use. Unauthorised modification or reconstruction is not permitted. Under no circumstances open the device or complete any repair work yourself.

### Installation location

Prevent excessive exposure to smoke, dust, vibration, chemicals, moisture, heat and direct sunlight.

Do not use the handset in potentially explosive areas.

### Power supply



**Caution:** Only use the power adapter plug supplied because other power supplies could damage the telephone. Ensure access to the power adapter plug is not obstructed by furniture or such.

### Rechargeable batteries



**Caution:** Do not throw batteries into a fire or immerse them in water.

### Power failure

The telephone cannot be used to make calls in the event of a power failure. Always keep a cord connected telephone which operates without an external power supply available in case of emergency situations.

### Medical equipment



**Caution:** Never use the telephone in the vicinity of medical equipment. It cannot be fully ruled out that devices will not be affected.

DECT<sup>1</sup> telephones can cause an unpleasant humming sound in hearing aids.

### Disposal

You are obliged to dispose of consumable goods properly in accordance with the applicable legal regulations. The adjacent symbol on the telephone indicates that electrical and electronic apparatus and batteries no longer required must be disposed of separate from domestic waste.

**Electrical and electronic devices** must be disposed of at a suitable collection point provided by the public waste authorities.

**Batteries** must be disposed of at the point of sale or at the appropriate collection points provided by the public waste authorities.

**Packaging materials** must be disposed of according to local regulations.



<sup>1</sup> DECT: Digitally Enhanced Cordless Telephone = Standard for cordless telephones.

## 2 Putting the Telephone into Operation

### Safety information



**Caution:** It is essential to read the Safety Information in Chapter 1 before starting up.

### Checking the contents of the package

The package contains:

- a base station with power adapter plug
- two handsets
- a charging station with power adapter plug
- a telephone connection cable
- four rechargeable batteries
- an operating manual

### Connecting the base station



**Caution:** Position the base station with a distance of 1 m to other electronic devices, otherwise there is a risk of mutual disturbance.

Connect the base station as illustrated in the diagram. For reasons of safety, only use the power adapter plug supplied and telephone connection line enclosed.

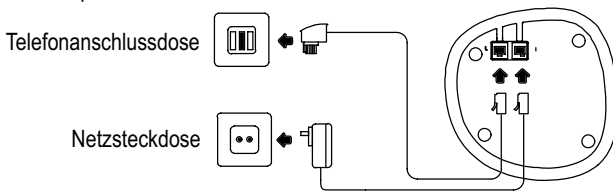

### Connecting the charging station

Connect the charging station as illustrated in the diagram. For reasons of safety, only use the power adapter plug supplied.

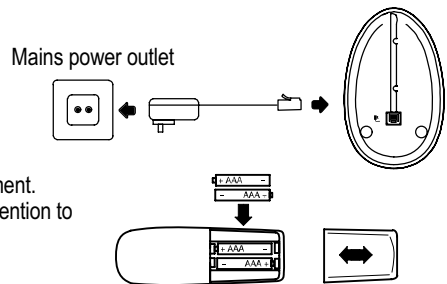

### Inserting the batteries

Insert the "AAA" batteries in the open battery compartment. Only use batteries of the type AAA NiMH 1.2 V. Pay attention to correct polarity. Close the battery compartment cover.

### Charging the batteries

Before the handset is used for the first time, insert it in the base station / charging station for at least 14 hours. When the handset is placed in the base station / charging station properly, the battery charge control lamp lights up. The handset warms up during the charging process. This is normal and does not represent a risk. Do not charge the handset with charging units from other manufacturers. The current **battery charge status** is indicated on the display:



Full



Half empty



Low



Empty

### Switching the handset on/off

The handset can be switched on and off to save the batteries.

2 sec

Switch the handset off

Switch the handset on

### Setting the date and time

The information on Page 82 explains how to set the date and time on the handset when starting it up for the first time.

### Private branch exchanges

Page 80 provides further information if your telephone is to be connected to a private branch exchange.

# Operating Elements

## 3 Operating Elements

### Handset

- 1 Scroll up / Redialling list
- 2 Softkey Right button
- 3 End call / Switch handset on/off
- 4 Keylock / Conference calls
- 5 Internal calls
- 6 R button
- 7 Scroll downwards / Missed calls
- 8 Take call / Handsfree mode
- 9 Softkey Left button

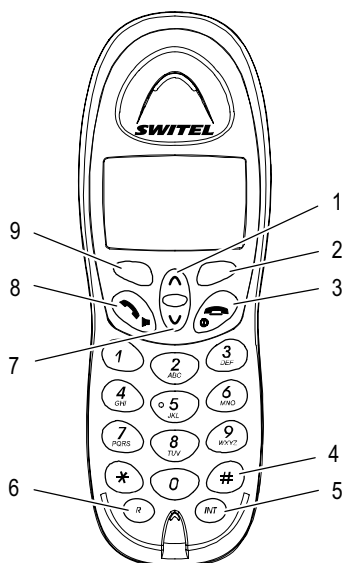

### Base station (answering machine)

- 1 Paging button (locate handset)
- 2 Volume -
- 3 Answering machine on/off
- 4 Volume +
- 5 Play previous message / Record memo
- 6 Stop
- 7 Play/Record outgoing message
- 8 LED, power lamp
- 9 Play next message / Set ring delay
- 10 Delete / security code
- 11 LED, charging control lamp
- 12 Play

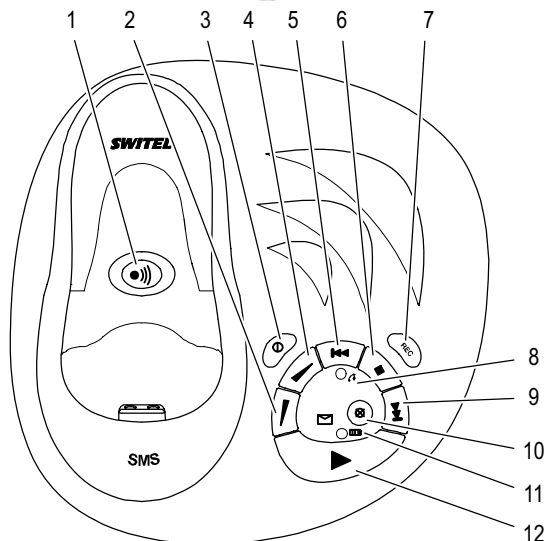

### Charging station

- 1 LED, charging control lamp

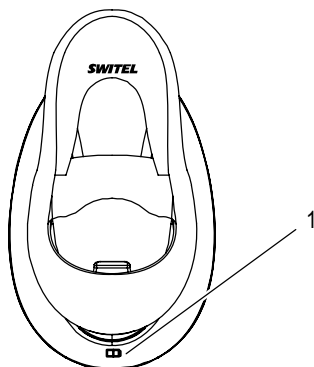













The buttons in this operating manual are depicted with a uniform contour. Variations in the symbols on the telephone buttons compared to those depicted here are possible.





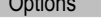















## 4 How to Operate the Telephone

### Display and explanation of operation sequences

	Enter digits or letters
	Press the button depicted briefly
2 sec 	Press the button depicted for 2 seconds
press and hold 	Press and hold button depicted
release 	Release button depicted
	Handset rings
	Base station rings
	Remove handset from the base station
	Place handset in the base station
Save Number 	Text and icon in the display
Options 	Press softkey  Page 74 Navigation buttons

### Icons in the display

Icon	Description
	On: Displays the battery capacity. Flashing: The batteries must be recharged. Run-through segments: Batteries are being charged.  Page 71
	Handsfree mode has been activated.  Page 76
	The key lock is activated.  Page 76
	The "Alarm" is switched on.  Page 82
	New calls have been stored in the calls list (CLIP).  Page 80
	A new <b>SMS</b> <sup>1</sup> message has been recorded.  Page 85
	Answering machine provided by the telephone network. <b>VMWI</b> <sup>2</sup> - Optional service provided by the telephone network provider  Page 80
	On: The connection to the base station is good. Flashing: The connection to the base station is not good. Move towards the base station.
1	Internally assigned call number of the handset.  Page 86
20:22	Display of the time.  Page 82
SWITEL	Display of the handset name.  Page 82

<sup>1</sup> SMS: Short Message Service

<sup>2</sup> VMWI: Visual Message Waiting Indication



# How to Operate the Telephone

## Navigation buttons

All descriptions in this operating manual assume that the handset is in Standby mode. The handset is in Standby mode after pressing the  button.

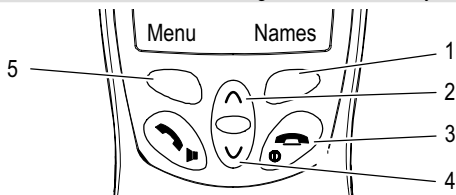







 The softkeys (1) and (5) are assigned different functions in the different menus. The function buttons are always referred to in this manual according to the texts directly above them in the display.



Button	In Standby mode	In Menu
1	- Open the phone book	- Move one level back
2 	- Opens the redialling list	- Scroll in the menu - Change the settings
3 	- Switch handset on/off	- Cancel programming and saving processes
4 	- Opens the list of missed calls	- Scroll in the menu - Change the settings
5	- Opens the main menu	- Opens the menu displayed

## Navigating in the menu





All the functions can be accessed via the various menus. Refer to the menu structure to find how to access the respective functions.  Page 81

Menu	Open the main menu
 or 	Select the submenu required
OK	Open the submenu
 or 	Select the function required
OK	Open the function
 or 	Select the setting required
	Enter digits or letters using the relevant digit keys
OK	Confirm the entries
Back	Move one level back
	Cancel programming and saving processes and return to Standby mode

 Every process is automatically cancelled if there is no input within 60 seconds.

## Creating a phone book entry - example

The way in which to navigate through the menus and enter data is explained by means of the example "Creating a phone book entry". Proceed as in this example for all the settings.

Names	Open the phone book
Options  or 	
Save Number  OK	Select function and confirm
 OK	Enter the name and confirm
 OK	Enter the phone number and confirm

## 5 Telephoning

### Taking a call

 ,  or  Take the call

### Ending a call

 or  End the call

### Making a call

 Enter the phone number (max. 25 digits)

Clear Delete the last digit if incorrect



 Dial the phone number

 It is also possible to press the Call button first to obtain the dialling tone. The digits in the phone number then entered are dialled immediately. It is not possible to correct wrong digits individually using this dialling procedure.

### Redialling

The telephone stores the last 20 phone numbers dialled in a redialling list.



 Open the redialling list

 or ,  Select an entry and dial the number

### Calling back missed calls

The telephone stores the numbers of the last 20 calls not taken in a calls list.



 Open the calls list

 or ,  Select an entry and dial the number

### Dialling phone numbers from the phone book

There must be phone numbers stored in the phone book.  Pages 74 and 84



Names Open the phone book

 or ,  Select an entry and dial the number

### Internal calls

#### Making internal calls



There must be two or more handsets (HS1, HS2, ...) registered on a base station in order to make internal calls free of charge.

HS1: , e.g.  Dial the internal call number of the required handset

HS2:  Take the internal call on the other handset



HS1 / HS2:  End the internal call

#### Transferring external calls internally

HS1: , e.g.  Dial the internal call number during the external call



HS2:  Take the internal call on the other handset

HS1:  Forward the call

 If the handset called does not answer, take the external call back by pressing the  button.

#### Holding a call / Brokering

While a call is in progress, it is possible to dial another handset in order to consult with someone. The external caller is put on hold while you converse with the second, internal person called. You can switch between the callers as often as necessary.

HS1: , e.g.  Dial the internal call number during the external call

HS2:  Take the internal call on the other handset

HS1:  Change back and forth between the callers

# Telephoning

## Conference calls

An external call can be transferred to another internal handset for a conference call.

HS1: , e.g.  Dial the internal call number during the external call

HS2:  Take the internal call on the other handset

HS1: 2 sec  Activate the conference call facility

HS1 / HS2:  The conference is terminated by one of the internal handset users ending the call

## Adjusting the receiver volume

The volume can be adjusted to one of 5 settings during a call.

or  Press the button during the call

## Talk time display

The duration of a call is displayed in minutes and seconds during the call.

## Handsfree

Use this function to listen to the caller via the loudspeaker.

Activate handsfree mode

Deactivate handsfree mode

## Muting the microphone in the handset

The microphone in the handset can be activated and deactivated during a telephone conversation.

Deactivate the microphone (muting function)

Activate the microphone

## Key lock

Calls can still be taken in the normal way even when the key lock function is activated.

2 sec   Activate the key lock function

,  Deactivate the key lock function

## Searching for the handset (Paging)

If you have mislaid your handset, you can locate it with the aid of a search tone.

Start the search tone

or  End the search tone

## 6 Answering Machine



The answering machine is provided with audio operator guidance. Pay attention to the vocal instructions and information.

### Language setting

The voice output of the answering machine is in English and cannot be changed.

### Setting the weekday and time

When a message is played back, the date and time of its receipt is also announced.

2 sec	Activate Setting mode
or ,	Set the weekday and confirm
or ,	Set the hour and confirm
or ,	Set the minute and confirm

### Playing back the weekday and time

	The weekday and time set are announced
--	--

### Switching the answering machine on/off

	Switch the answering machine on/off
--	-------------------------------------

### Maximum recording time

The answering machine can record up to 60 messages. The maximum recording time is 16 minutes. The maximum length of a message is 2 minutes. When there is no memory capacity available to record new messages, no further messages are recorded.

### Setting the volume

The playback volume can be set to one of 11 levels.

or	Set the volume
----	----------------

### Delay in taking calls

It is possible to set the delay, after which the answering machine takes the call, to between 2 and 9 rings or to activate the **toll-saver** function to enable pre-remote access free of charge. The free pre-remote access function enables you to determine whether new messages have been recorded without accumulating any telephone charges.

- If new messages have been recorded on the answering machine, your call is taken after 2 rings.
- If no messages have been recorded, the call is taken after 4 rings. So, replace the receiver before the 4th ring. No charges for the call will be made.

Press and hold	Activate Setting mode
Release	Select the required setting

Further information on remote access, Page 78

### Take a call during recording

It is possible to take a call which is already being answered by the answering machine. Recording of the message is stopped in this case.

or	Take the call
----	---------------

### Select answering mode

The answering machine is provided with two, pre-recorded outgoing messages. After outgoing message 1 (OGM 1) has been played, a message can be recorded. Outgoing message 2 (OGM 2), however, is simply an announcement after which no message can be left. OGM 1 and OGM 2 can be replaced by your own outgoing messages. When the memory capacity of the answering machine is full, the system automatically activates OGM 2.

2 sec <b>REC</b>	Activate Setting mode
	Activate OGM 1
	Activate OGM 2

# Answering Machine

## Recording/Controlling/Deleting outgoing messages

### Recording an outgoing message

The outgoing message recorded can be maximally 40 seconds long.

2 sec Activate Setting mode

Press and hold Start recording (OGM 1)

Release End recording (OGM 1)

Press and hold Start recording (OGM 2)

Release End recording (OGM 2)

### Checking the current outgoing message

Play the outgoing message

### Deleting your own outgoing message and reverting to the default message

After deleting your own outgoing message, the default, pre-recorded message is automatically reactivated.

Play the outgoing message

Press during playback to delete the outgoing message

## Recording a memo

A memo is an internal message which can be played as a normal incoming message.

### Recording the memo

A memo cannot be longer than 2 minutes.

Press and hold Start recording

Release End recording

## Playing/Deleting recorded messages/memos

### Playing messages / memos

The recorded messages/memos are played back in the sequence they were recorded. The weekday and time of recording are announced before the respective message or memo is played back.

2 sec Play new messages / memos

Play all messages / memos

Stop playback

Repeat playback of message

Skip to next message

### Deleting a message / memo

Play the message / memo to be deleted

Press during playback to delete the message / memo

## Deleting all messages / memos

All the messages / memos are deleted. This means that new messages / memos are also deleted. Play all the messages / memos. After having played all the messages / memos you can delete them.

Play all messages / memos

Delete all the messages / memos

## Remote access

You can call your answering machine to listen to any messages left and carry out other functions. A condition for this is the use of a telephone which implements tone dialling mode.

### Security code for remote access

To be able to use the remote access function, you must enter a security code. The default security code set at the factory is "000".

2 sec Activate Setting mode

or , Enter the 1st digit and confirm

or , Enter the 2nd digit and confirm

or , Enter the 3rd digit and confirm

## Starting remote access



Dial your own phone number



Press the button while the outgoing message is playing and enter the security code



If the code entered is incorrect, the answering machine's outgoing message is played again. If the security code is entered incorrectly three times, the line is automatically disconnected.

Other functions can now be carried out. Key function assignment table

## Remote activation of the answering machine



Dial your own phone number



If you have forgotten to switch the answering machine on, the call is taken after the 20 ring.



Press the button after the acoustic signal and enter the security code



Switch the answering machine on/off

Other functions can now be carried out. Key function assignment table

## Key function assignment for remote access



The remote access function is automatically cancelled if there is no input within 10 seconds.

The function assigned to the respective keys is dependent on the menu currently open. The following table provides an overview of the respective functions assigned to the individual buttons.

Button	1 Functions in the main menu	8 Functions in the OGM menu
1	Play the main menu again	<b>Open and play the main menu</b>
2	Play all the messages	Play the outgoing message currently set
3	Play the new messages only	Record OGM 1  Page 78
4	Play the current message again	Record OGM 2  Page 78
5	<ul style="list-style-type: none"> <li>Delete the current message</li> <li>Delete all messages (after playing all message / memos)</li> </ul>	<ul style="list-style-type: none"> <li>Activate OGM 1  Page 78</li> <li>Delete OGM 1 or 2 (play outgoing message and delete during playback)</li> </ul>
6	Play the next message	Activate OGM 2  Page 78
7	Switch the answering machine on/off	
8	Open and play the OGM menu	Play the OGM menu again
9	Set the security code <b>Activate Setting mode:</b> * <b>Set security code:</b> e.g. "000" = 0, 0, 0 <b>Confirm setting:</b> #	
0	Set weekday and time <b>Activate setting mode:</b> * <b>Set weekday:</b> Monday = 1, Tuesday = 2, Wednesday = 3, Thursday = 4, Friday = 5, Saturday = 6, Sunday = 7 <b>Set time:</b> e.g. 10:15 = 1, 0, 1, 5 <b>Confirm setting:</b> #	
*	Activate Setting mode	
#	Confirm setting	End recording
	Replace the receiver to end remote access	

## 7 PABX / Supplementary Services

### R button on private branch exchanges

If the telephone is connected to a private branch exchange, functions such as transferring calls and automatic call back can be used via the **R button**. Please refer to the operating manual supplied with your private branch exchange to determine which recall (Flash) time must be set in order to use these functions. The dealer where you purchased the exchange can provide information as to whether the telephone will work properly with the exchange. Setting the recall time  Page 82

### Access code (number for an outside line)

In the case of private branch exchanges, it is necessary to enter an access code to get an outside line with its corresponding dialling tone. If a number for an outside line has been stored and activated in your handset, this number for an outside line is automatically predialled before the phone numbers in the phone book and the various calls lists.

### Dialling pause

In the case of private branch exchanges, it is necessary to enter an access code to get an outside line with its corresponding dialling tone. When using some older private branch exchanges, it takes a little time before the dialling tone becomes audible. Particularly in the case of such private branch exchanges, it is possible to insert a dialling pause after the number for the outside line so that the number can be dialled in a continuous process without having to wait for the dialling tone.

2 sec  Insert dialling pause

After dialling the number for the outside line, the telephone then waits 3 seconds before dialling the actual phone number.

 The pause can also be entered with the phone number in the phone book.

### R button and supplementary services

Your telephone supports the supplementary services offered by your telephone network provider, such as brokering, call waiting and conference calls. The supplementary services can be used in conjunction with the **R button**. Please contact your telephone network provider regarding which recall time must be set to use the supplementary services. Please contact the telephone network provider with regard to enabling the supplementary services. Setting the recall time  Page 82

### Answering machine in the telephone network

If your telephone network provider has an answering machine available for you in the telephone network, the icon (**VMWI**<sup>1</sup>) indicates a new message has been recorded for you. The provision of an external answering machine and indication of new messages via an icon are optional services from the telephone network provider. These functions can only be used when your telephone network provider actually offers the service. Contact your network provider for further information.

### Call number display (CLIP<sup>2</sup>)

If this function is available with your telephone line, the number of the caller appears in the display when the phone rings. If the caller has suppressed transmission of his phone number, a corresponding message appears in the display. The phone number is not displayed and, as a result, is not stored in the calls list.

 The caller number display function is an optional service offered by telephone network providers. Contact your network provider for further information.

<sup>1</sup> **VMWI**: Visual Message Waiting Indication

<sup>2</sup> **CLIP**: Calling Line Identification Presentation



## 8 Menu Structure

### Main menu

Press the **Menu** softkey to access the main menu.

SMS <sup>1</sup>	Write Message	Options	Send to	Search
			Save	
			Insert Symbol	
			User Name	Default User
				Users 1-4 ▶
				▶  Password
	Inbox	Read	Options	Reply
				Forward
				Delete
	Outbox	Read	Options	Edit
	Delete Messages	Inbox		Send to
		Outbox		Clear
		All Messages		User Name
	Settings	Service Centres	Receive Centre	Receive Centre
			Sending Centre	Sending Centre
		Terminal Number	Terminal Number	
		SMS Alert	On/Off	
			Set Alert	Morse
				Discreet
				Polyphonic
		Users	Delete User	Users 1-4
			Add User	User Name ▶
			▶  Password	Retype

Calls lists <sup>2</sup>	Received calls	Options	Delete
			Show Details
			Add Entry
	Missed call	Options	Delete
			Show Details
			Add Entry
	Dialled calls	Options	Delete
			Show Details
			Add Entry
	Delete Calls List	Received calls	
		Missed call	
		Dialled calls	
		All Calls	

<sup>1</sup> Further information on SMS text messages Page 84

<sup>2</sup> The caller number display function (**CLIP**<sup>3</sup>) must be enabled to display and save phone numbers in calls lists. The caller number display function is an optional service offered by telephone network providers. Contact your network provider for further information.

Further information on caller number display Page 80

<sup>3</sup> **CLIP**: Calling Line Identification Presentation

# Menu Structure

Handset	Ringtone	External Calls	Base Melody 1-5
		Internal Calls	Base Melody 1-5
	Ring Volume	Ring Volume 1-5 / Off	
	Handset Name	Name:	
	Language <sup>1</sup>	Language 1-7	
	Menu Colour	Blue	
		Green	
		Pink	
	Auto Talk <sup>2</sup>	On/Off	
	PABX Access Code <sup>3</sup>	On/Off	
		Set Code	

Base settings	Base Ringtone	Base Melody 1-5		
	Base Volume	Base Volume 1-5 / Off		
	Handset Priority <sup>4</sup>	All Handsets		
		Select Handset	Handset 1-5	Rings 2
				Rings 4
				Rings 6
	Recall Mode	Recall 1 (100 ms)		
		Recall 2 (300 ms)		
	System PIN <sup>5</sup>	Enter Old PIN:	Enter New PIN:	
			Confirm New PIN:	

Time settings	Alarm	On/Off	On Once	Time (24 Hr):
			On Daily	Time (24 Hr):
			Off	
		Set Alarm Tone	Alarm Tone 1-4	
	Set Date & Time	Date:	Time (24 Hr):	

Registration	Register Handset	Base 1-4	System PIN <sup>5</sup>
	Select Base	Automatic	
		Base 1-4	
	De-register	System PIN <sup>5</sup>	Handset 1-5

<sup>1</sup> Languages: English, French, German, Italian, Spanish, Dutch and Portuguese.

<sup>2</sup> If this function is activated, a call is automatically taken on removing the handset from the base station.





<sup>3</sup> Further information on private branch exchanges Chapter 7.

<sup>4</sup> You can define whether all handsets should ring when a call is received or just one, specific handset with priority should ring initially.

<sup>5</sup> Default System PIN: 0000

## Phone book

Press the **Names** softkey to open the phone book.

Entry 1	Options	Add Entry	 Name: <sup>1</sup>	 Number:
Entry 2		Show Details		
Entry ...		Delete Entry		
		Edit Entry	 Name: <sup>1</sup>	 Number:
		Ringtone <sup>2</sup>	Off	
			Base Melody 1-5	
		Delete all phonebook		

<sup>1</sup> The digit keys are also labelled with letters. Letters, digits and special characters are entered by pressing the relevant key the respective number of times.

<sup>2</sup> A phone book entry can be assigned a specific ringing melody. The handset then rings with this melody when a call is received from this caller. The caller number display function (**CLIP**<sup>3</sup>) must be enabled to use this function. The caller number display function is an optional service offered by telephone network providers. Contact your network provider for further information.

<sup>3</sup> **CLIP: Calling Line Identification Presentation**

## 9 SMS

### Conditions for using SMS

The **CLIP**<sup>1</sup> feature must be enabled for your telephone connection. Contact your telephone network provider to ensure this feature is enabled on your telephone connection. To use the **SMS**<sup>2</sup> service, your telephone network provider must enable it.

- SMS messages cannot be sent from private branch exchanges.
- Sending SMS messages is not available for Call-by-Call connections at present.
- Charges are made for sending SMS texts.
- If the recipient in the conventional telephone network does not use an SMS service or his telephone is not basically equipped to handle SMS messages, the SMS is automatically converted to a voice message.
- Costs are charged by your telephone network provider.

### SMS service centre

SMS messages are distributed via a Service Centre. If you want to send SMS text messages, you must program a service centre number in your handset  Page 81. Please contact the provider of your choice for the necessary service centre call numbers and the procedure for enabling the SMS service.



Your telephone has already been prepared to send SMS text messages. Service Centre numbers are already programmed in the handset.

Receive Service Centre

Swisscom: 0622 100 000

Sending Service Centre

Swisscom: 0622 100 000

### Entering text

The digit keys are also labelled with letters for the entry of the respective letters. Letters, digits and special characters are entered by pressing the relevant key the respective number of times.

<b>1</b>	Enter a space and special characters
<b>INT</b>	Change between upper and lower case
<b>Clear</b>	Delete the last character entered
2 sec <b>Clear</b>	Delete the entire entry and return to Standby mode

### Terminal number

In case several telephones equipped with SMS functionality are connected to one telephone connection, each telephone is identified by a terminal number. To send an SMS to a certain telephone, the sender of the message must know its terminal number and append it to the phone number.

### Mailbox

In addition to the basic mailbox already available with the terminal number "0", you can set up four more mailboxes and protect them by means of a password. Each mailbox is identified by a user name and a terminal number. This enables text messages to be received to which only the respective user has access.



Mailboxes with different terminal numbers can only be used when the telephone network provider supports the facility. Please request instructions on setting up mailboxes from your telephone network provider.

<sup>1</sup> **CLIP**: Calling Line Identification Presentation

<sup>2</sup> **SMS**: Short Message Service

## 10 Multiple Handsets / Base Stations

### Multiple Handsets

The international **GAP**<sup>1</sup> Standard ensures that SWITEL handsets and handsets from other manufacturers can be integrated in the telephone system. In the same way, an SWITEL handset can be registered on base stations from other manufacturers as long as they comply with the GAP Standard.



At least two handsets must be registered on a base station in order to deregister a handset from that base station. Before registering handsets on a new base station, the handsets should be deregistered from the old one first.

### Registering handsets

Up to 5 handsets can be registered on the base station. The handset is automatically assigned an internal call number following registration. The internal call number appears in the display.

#### Registering CD77382 handsets on CD77382 base stations

5 sec

Set the CD77382 base station to Register mode

Register the handset. Page 82

#### Registering CD77382 handsets on base stations from other manufacturers

Follow the instructions in the operating manual from the original manufacturer to set the base station from the external manufacturer to Register mode. Use the PIN code from the external manufacturer for the registration.

Register the handset. Page 82

#### Registering handsets from other manufacturers on CD77382 base stations

5 sec

Set the base station to Register mode

Follow the instructions on registering handsets in the operating manual from the external manufacturer. Use the currently valid PIN code to register (default setting: 0000).

### Multiple Base Stations

Your handsets can be registered simultaneously on up to 4 different base stations. CD77382 base stations can be used for this or base stations from other manufacturers as long as the devices comply with the **GAP**<sup>1</sup> Standard. All base stations require their own telephone line socket. The base stations can be connected to telephone line sockets with the same call number and even to connections with different call numbers.

#### Mobility through registration at various locations

Register the handset on base stations at various locations. The handset automatically logs on to the nearest base station, as long as the "Automatic" function is activated. Page 82

#### Increasing the range

Position the base stations so that the ranges of the individual base stations overlap. If necessary, test the range of your handsets. Obstructions in buildings can reduce the range considerably.



Calls in progress, however, cannot be transferred from one base station to another.

<sup>1</sup> **GAP: Generic Access Profile** = Standard for the interoperation of handsets and base stations from other manufacturers.

# In Case of Problems

## 11 In Case of Problems

### Service hotline

Should problems arise with the telephone, please refer to the following information first. In the case of claims under the terms of guarantee, contact your sales outlet.

### Problems and solutions

Problems	Solutions
No connection to base station possible	<ul style="list-style-type: none"><li>- Check that the handset has been registered on the base station with the correct PIN code. ☞ Page 82</li></ul>
No telephone calls possible	<ul style="list-style-type: none"><li>- The telephone line is not connected properly or is defective. Only use the telephone connection cable supplied.</li><li>- Test whether the telephone connection is in order by using another telephone.</li><li>- The power adaptor plug is not plugged in or there is a complete power failure.</li><li>- The rechargeable batteries are empty or defective.</li><li>- The handset is too far from the base station.</li></ul>
Connection is disturbed or cut off	<ul style="list-style-type: none"><li>- The handset is too far from the base station.</li><li>- The base station is in an unsuitable location.</li></ul>
The system no longer responds	<ul style="list-style-type: none"><li>- Disconnect the power adapter plug briefly from the power socket.</li><li>- Reset the default settings. ☞ Page 87</li></ul>
The batteries are empty in a short time	<ul style="list-style-type: none"><li>- Batteries are empty or defective.</li><li>- Place the handset in the base station properly. Clean the contact surfaces on the handset and base station with a soft, dry cloth.</li><li>- Place the handset in the base station for 14 hours.</li></ul>
The caller number display (CLIP) does not function	<ul style="list-style-type: none"><li>- The caller number display function is an optional service offered by telephone network providers. Contact your network provider for further information.</li><li>- The caller has suppressed the transmission of their phone number.</li></ul>
The answering machine does not take calls	<ul style="list-style-type: none"><li>- Ensure that the answering machine is connected correctly and switched on.</li><li>- Check whether the answering machine memory is full. Delete messages from the memory, if necessary. ☞ Page 78</li></ul>
No memo can be recorded	<ul style="list-style-type: none"><li>- Check whether the answering machine memory is full. Delete messages from the memory, if necessary. ☞ Page 78</li></ul>
No remote access functions can be executed	<ul style="list-style-type: none"><li>- Check that the correct security code has been entered for the remote access. ☞ Page 78</li><li>- The telephone to be used for remote access must be set to tone dialling.</li></ul>

## 12 Technical Properties

### Technical data

Feature	Value
Standard	<b>DECT<sup>1</sup>-GAP<sup>2</sup></b>
Power supply	Input: 220/230 V, 50 Hz Output: 8 V, 300 mA / 9 V, 120 mA
Range	Outdoors: Approx. 300 m Indoors: Approx. 50 m
Standby	more than 110 h
Max. talk time	up to 12 h
Rechargeable batteries	2 x 1.2 V, size: AAA
Dialling mode	Tone dialling mode
Permissible ambient temperature	10°C to 30°C
Permissible relative humidity	20% to 75%
Recall (Flash) function	90 ms, 250 ms

### Resetting the Default settings

2 sec <input type="button" value="⓪"/>	Switch the handset off
<input type="button" value="⓪"/> , wait 2 sec., <input type="button" value="✳"/>	Switch handset on, wait and initiate the reset
<input type="text" value="Default settings"/> <input type="button" value="OK"/>	Confirm the reset process
<input type="text" value="Default settings"/> <input type="button" value="Back"/>	Cancel the reset process

### Default settings

	<b>SMS Settings</b>
Language: German	
Handset name: CD7738	Inbox: no message
Handset number: 1	Outbox: no message
Phonebook: Empty (150 entries)	Receiving center: Swisscom: 0622 100 000
Receive call/Missed call: Empty (50 entries)	Sending center: Swisscom: 0622 100 000
Dial call: Empty (20 entries)	Alert: ON
Auto answer: ON	Melody on message receipt: Morse
RING volume: 3	Users: "Add user"
EAR Volume: 3	Terminal nr.: 0
INT call Melody: 1	<b>Base station</b>
EXT call Melody: 5	Recall: 1 (90 ms)
Menu color: Blue	Base volume: 3
Alarm: OFF	Base Melody: 5
Key Lock: OFF	PIN code: 0000

<sup>1</sup> **DECT**: Digitally Enhanced Cordless Telephone = Standard for cordless telephones.

<sup>2</sup> **GAP**: Generic Access Profile = Standard for the interoperation of handsets and base stations from other manufacturers.

# Technical Properties

---

Default settings, answering machine

OGM: OGM1	Answer delay: 6 Rings
Memory: Empty	Answer off delay: 20 Rings
Security code: 000	Answer VOL: 5
Answer Mode: ON	Time / Day stamp: Saturday / 12:01 pm



## 13 Maintenance / Guarantee

### Maintenance

- Clean the housing surfaces with a soft, fluff-free cloth.
- Never use cleaning agents or solvents.

### Guarantee

SWITEL equipment is produced and tested according to the latest production methods. The implementation of carefully chosen materials and highly developed technologies ensure trouble-free functioning and a long service life. The terms of guarantee do not apply where the cause of equipment malfunction is the fault of the telephone network operator or any interposed private branch extension system. The terms of guarantee do not apply to the batteries or power packs used in the products. The period of guarantee is 24 months from the date of purchase.

All deficiencies resulting from material or production faults which occur during the period of guarantee will be eliminated free of charge. Rights to claims under the terms of guarantee are annulled following intervention by the purchaser or third parties. Damage caused as a result of improper handling or operation, incorrect positioning or storing, improper connection or installation, Acts of God or other external influence are not covered by the terms of guarantee. In the case of complaints, we reserve the right to repair or replace defect parts or provide a replacement device. Replacement parts or devices become our property. Rights to compensation in the case of damage are excluded where there is no evidence of intent or gross negligence by the manufacturer.

If your device shows signs of defect during the period of guarantee, please return it to the sales outlet in which you purchased the SWITEL device together with the purchase receipt. All rights to claims under the terms of guarantee in accordance with this agreement must be asserted exclusively with regard to your sales outlet. Two years after the purchase and transfer of our products, claims under the terms of guarantee can no longer be asserted.

# Index

## 14 Index

### A

- Access code, 80
- Answering machine, 77
- Answering machine in the telephone network, 80

### B

- Battery charge status, 71
- Brokering, 75

### C

- Call number display, 80
- Calling back missed calls, 75
- Calls lists, 81
- Charging the batteries, 71
- Conference calls, 76
- Connecting the base station, 71
- Connecting the charging station, 71
- Creating a phone book entry, 74

### D

- Default settings, 87
- Delay in taking call, 77
- Deleting all messages / memos, 78
- Deleting messages / memos, 78
- Deleting outgoing messages, 78
- Dialling pause, 80
- Dialling phone numbers from the phone book, 75
- Display, 73

### E

- Ending a call, 75
- Entering text, 84
- Explanations, 73

### G

- Guarantee, 89

### H

- Handsfree, 76
- Holding a call, 75
- How to operate the telephone, 73

### I

- Icons in the display, 73
- Increasing the range, 85
- Inserting the batteries, 71
- Internal calls, 75

### K

- Key function assignment, 79
- Key lock, 76

## M

- Mailbox, 84
- Main menu, 81
- Maintenance, 89
- Making a call, 75
- Making internal calls, 75
- Maximum recording time, 77
- Mobility, 85
- Multiple base stations, 85
- Multiple handsets, 85
- Muting the microphone, 76

## N

- Navigating in the menu, 74
- Navigation buttons, 74
- Number for an outside line, 80

## O

- Operating elements, 72

## P

- Package contents, 71
- Paging, 76
- Phone book, 83
- Playing messages / memos, 78
- Private branch exchanges, 71, 80
- Putting the Telephone into Operation, 71

## Q

- Problems and solutions, 86

## R

- R button on private branch exchanges, 80
- R-button and supplementary services, 80
- Receiver volume, 76
- Recording a memo, 78
- Recording outgoing messages, 78
- Redialling, 75
- Registering handsets, 82, 85
- Remote access, 78
- Remote activation of the answering machine, 79
- Reset, 87

## S

- Safety Information, 70
- Searching for the handset, 76
- Security code for remote access, 78
- Select answering mode, 77
- Service hotline, 86
- Setting the answering machine language, 77
- Setting the answering machine volume, 77
- Setting the answering machine weekday and time, 77
- Setting the date and time, 71, 82
- SMS, 81, 84
- SMS conditions, 84
- SMS Service Centre, 84
- Structure of the menu, 81
- Supplementary services, 80
- Switching the answering machine on/off, 77
- Switching the handset on/off, 71

## T

- Take call during recording, 77
- Taking a call, 75
- Talk time, 76
- Technical data, 87
- Telephoning, 75
- Terminal number, 84
- Toll-saver, 77
- Transferring external calls internally, 75

## V

- VMWI, 80



# SWITEL

## Declaration of conformity

WE TELGO AG  
OF Route d'Englisberg 17  
CH-1763 Granges-Paccot

Declare under our own responsibility that the product

MODEL: CD77382

DESCRIPTION: Cordless DECT telephone

Is in conformity with directives: R&TTE Directive (1999/5/EC)

COMPLIANCE IS ACHIEVED BY CONFORMITY TO THE FOLLOWING:

TEST REPORT NUMBERS:

AUTHORISED BY:

Signed:



---

Name (printed):

Selim Dusi

Position in company:

Managing Director

Date of issue:

Copies of this document will be held on file for a period of 10 years after the last production.



Supplier: TELGO AG, Route d'Englisberg 17  
CH-1763 Granges-Paccot  
Product: CD77382

This product is intended for connection to analogue PSTN lines within Switzerland.  
However, due to differences between the individual PSTNs provided in the different countries, the approval does not, of itself, give an unconditional assurance of successful operation on every PSTN network termination point.