

SWITEL

COMMUNICATION PRODUCTS

Schnurlostelefon
Téléphone sans fil
Telefono senza fili
Cordless telephone

CD7702



Bedienungsanleitung
Mode d'emploi
Istruzioni per l'uso
Operating Instructions

SWITEL CD7702

Bedienungsanleitung	3
Mode d'emploi	33
Istruzioni per l'uso	63
Operating Instructions	93
Declaration of Conformity	124

1	Allgemeine Hinweise	5
1.1	Bestimmungsgemäße Verwendung	5
1.2	Stromausfall	5
1.3	Aufstellungsort	5
1.4	Netzteil	5
1.5	Aufladbare Standard-Akkus	5
1.6	Laden des Mobilteils	5
1.7	Nebenstellenanlagen	5
1.8	Rückgabe von Altgeräten	5
1.9	Hinweis für medizinische Geräte	5
1.10	Temperatur und Umgebungsbedingungen	5
1.11	Reinigung und Pflege	5
2	Leistungsmerkmale	6
2.1	Telefon	6
3	Bedienelemente	7
3.1	Mobilteil	7
3.2	Basisstation/Ladestation	7
4	Inbetriebnahme	8
4.1	Sicherheitshinweise	8
4.2	Verpackungsinhalt prüfen	8
4.3	Basisstation anschließen	8
4.4	Ladestation anschließen	8
4.5	Standard-Akkus einsetzen	8
4.6	Aufladen der Standard-Akkus	8
4.7	Tonwahl - MFV	8
5	Bedienung	9
5.1	Das Display	9
5.2	Die Navigation mit den Tasten	9
5.3	Anruf führen und beenden	9
5.4	Anruf annehmen	9
5.5	Zwei externe Anrufe entgegennehmen	9
5.6	Freisprechen	10
5.7	Rufnummern aus dem Telefonbuch wählen	10
5.8	Anzeige der Gesprächsdauer	10
5.9	Einstellen der Hörerlautstärke	10
5.10	Wahlwiederholung	10
5.11	Mobilteil stummschalten	10
5.12	Mobilteil ein- /ausschalten	10
5.13	Mobilteil suchen (Paging)	10
5.14	Tastensperre	10
5.15	Hinweise zur Reichweite	10
6	Nebenstellenanlagen / Zusatzdienste	11
6.1	R-Taste an Nebenstellenanlagen	11
6.2	R-Taste und die Zusatzdienste der Swisscom	11
6.3	Wahlpause	11
7	Menüstruktur	12
8	Das Telefonbuch	14
8.1	Rufnummer in das Telefonbuch eingeben	14
8.2	Details des Eintrages anzeigen	14
8.3	Gespeicherte Einträge im Telefonbuch ändern	14
8.4	Eintrag aus dem Telefonbuch löschen	15
8.5	Alle Einträge aus dem Telefonbuch löschen	15
8.6	VIP-Ruf (Ruftonzuordnung)	15
9	SMS-Nachrichten	16
9.1	Service Center	16
9.1.1	Sende-/Empfangsnummer eingeben	16
9.2	Schreiben und versenden	16
9.3	Gespeicherte SMS-Nachricht versenden	17

- Inhaltsverzeichnis -

9.4	Lesen und beantworten	17
9.5	Nachrichtenton Ein/Aus	17
9.6	Nachrichtenton einstellen (Morseton, Diskret, Polyphon)	18
9.7	SMS-Nachricht löschen	18
9.8	Alle SMS-Nachrichten löschen	18
9.9	SMS-Postfach	18
9.9.1	Postfach/Benutzer hinzufügen	18
9.9.2	Postfach/Benutzer-Daten anzeigen	19
9.9.3	SMS-Nachricht an persönliches Postfach senden	19
9.9.4	Postfach/Benutzer-Daten ändern	19
9.9.5	Postfach/Benutzer löschen	19
10	Anruferlisten	20
10.1	Rufnummernanzeige (Clip)	20
10.2	Eingegangene Anrufe	20
10.2.1	Anzeigen und zurückrufen	20
10.2.2	Eintrag löschen	20
10.2.3	Eintrag im Telefonbuch speichern	20
10.3	Entgangene Anrufe	21
10.3.1	Anzeigen und zurückrufen	21
10.3.2	Eintrag löschen	21
10.3.3	Eintrag im Telefonbuch speichern	21
10.4	Gewählte Nummern (Wahlwiederholung)	21
10.4.1	Anzeigen und anrufen	21
10.4.2	Eintrag löschen	21
10.4.3	Eintrag im Telefonbuch speichern	22
10.4.4	Eine Anruferliste löschen	22
10.4.5	Alle Anruferlisten löschen	22
11	Mobilteil	23
11.1	Ruftonmelodie zuweisen (interne und externe Anrufe)	23
11.2	Ruftonlautstärke einstellen	23
11.3	Namen des Mobilteils eingeben/ändern	23
11.4	Sprache einstellen	23
11.5	Menüfarbe einstellen	23
11.6	Automatische Gesprächsannahme aktivieren	24
11.7	Zugangskode (Amtskennziffer) aktivieren	24
12	Mobilteile an- und abmelden	25
12.1	Mobilteil anmelden	25
12.2	Mobilteil abmelden	25
12.3	Basis auswählen	25
13	Mehrere Mobilteile	26
13.1	Intern telefonieren	26
13.2	Externe Gespräche an ein anderes Mobilteil weiterleiten	26
13.3	Konferenzgespräche führen	26
14	Basis-Einstellungen	27
14.1	Ruftonmelodie der Basisstation zuweisen	27
14.2	Ruftonlautstärke der Basisstation einstellen	27
14.3	Vorrangiges Klingeln eines Mobilteils aktivieren/deaktivieren	27
14.4	Flashzeiten einstellen	27
14.5	System-PIN ändern	28
14.6	Werkseinstellungen wiederherstellen	28
15	Zeiteinstellung	29
15.1	Zeit und Datum einstellen	29
15.2	Weckton einstellen	29
15.3	Weckzeit eingeben (EIN/AUS)	29
16	Fehlerbeseitigung	30
17	Wichtige Informationen	31
17.1	Technische Daten	31
17.2	Garantie	31

1 Allgemeine Hinweise

Bitte lesen Sie diese Bedienungsanleitung sorgfältig durch. Öffnen Sie das Gerät in keinem Fall selbst und führen Sie keine eigenen Reparaturversuche durch. Bei Gewährleistungsansprüchen wenden Sie sich bitte an Ihren Fachhändler. Im Zuge von Projektverbesserungen behalten wir uns technische und optische Veränderungen am Artikel vor.

1.1 Bestimmungsgemäße Verwendung

Dieses Telefon ist für den Betrieb an einem analogen Telefonanschluss (PSTN) innerhalb der Schweiz entwickelt worden. Allerdings kann, wegen der Unterschiede zwischen den verschiedenen Telekommunikations-Netzbetreibern, keine Garantie für einwandfreie Funktion an jedem Telekommunikations-Endgeräteanschluss übernommen werden. Schließen Sie das Anschlusskabel des Telefons nur an eine dafür bestimmte Telefonsteckdose an. Wechseln Sie den Stecker des Anschlusskabels nicht aus.

1.2 Stromausfall

Bei Stromausfall kann mit dem Telefon nicht telefoniert werden. Halten Sie für eventuelle Notfälle ein schnurgebundenes Telefon bereit, welches ohne eine externe Stromversorgung arbeitet.

1.3 Aufstellungsort

Der Aufstellungsort hat einen entscheidenden Einfluss auf einen einwandfreien Betrieb des Telefons. Am Aufstellungsort muss sich eine 230 Volt Netzsteckdose befinden.

Stellen Sie die Basisstation nicht in die unmittelbare Umgebung von anderen elektronischen Geräten wie z. B. Mikrowellen oder HIFI-Geräten, da es sonst zu gegenseitiger Beeinflussung kommen kann. Halten Sie einen Abstand von mindestens einem Meter zu elektronischen Geräten ein.

Stellen Sie die Basisstation auf eine ebene und rutschfeste Fläche. Normalerweise hinterlassen die FüÙe der Basisstation keine Spuren auf der Aufstellfläche. Wegen der Vielzahl der verwendeten Lacke und Oberflächen kann es jedoch nicht ausgeschlossen werden, dass durch die GerätefüÙe Spuren auf der Abstellfläche entstehen.

1.4 Netzteil

Verwenden Sie nur das mitgelieferte SWITEL Steckernetzteil, da andere Netzteile das Telefon zerstören können. Es besteht Lebensgefahr, wenn das Netzteil geöffnet und nicht vom Stromnetz getrennt wird.

1.5 Aufladbare Standard-Akkus

Verwenden Sie die mitgelieferten aufladbaren Standard-Akkus. Verwenden Sie beim Austauschen immer nur Standard-Akkus des Typs AAA 1,2V 750 mAh. Andere Standard-Akkus oder Akkupsacks können einen Kurzschluss verursachen. Werfen Sie Standard-Akkus nicht ins Feuer und tauchen Sie sie nicht ins Wasser. Entsorgen Sie alte oder defekte Standard-Akkus nicht mit dem normalen Hausmüll. 

Die angegebenen maximalen Standby- und Gesprächszeiten gelten für die mitgelieferten wiederaufladbaren Standard-Akkus bei optimalen Bedingungen. Umgebungstemperatur, Aufladezyklus und weitere äußere Einflussfaktoren, wie z. B. Funkbelastung an der Einsatzumgebung, können die Leistungszeiten erheblich verringern. Die Ladekapazität reduziert sich darüber hinaus technisch bedingt im Verlauf der Nutzung oder durch Lagerung bei sehr hohen oder niedrigen Temperaturen.

1.6 Laden des Mobilteils

Das Mobilteil erwärmt sich beim Laden. Dies ist normal und ungefährlich. Laden Sie das Mobilteil nicht mit fremden Aufladegeräten, da sonst Beschädigungen auftreten können.

1.7 Nebenstellenanlagen

Das Telefon kann auch an einer Nebenstellenanlage angeschlossen werden. Ob Ihr Telefon an Ihrer Nebenstellenanlage einwandfrei funktioniert, erfahren Sie bei dem Händler, bei dem die Nebenstellenanlage gekauft wurde. Es kann **nicht** garantiert werden, dass das Telefon an jeder Nebenstellenanlage funktioniert.

1.8 Rückgabe von Altgeräten

Wenn Sie Ihr SWITEL-Gerät entsorgen wollen, bringen Sie es bitte zur Sammelstelle Ihres kommunalen Entsorgungsträgers (z. B. Wertstoffhof).

Das nebenstehende Symbol auf Ihrem Telefon bedeutet, dass das Altgerät **nicht im Hausmüll** entsorgt werden darf. Nach dem Elektro- und Elektronikgerätegesetz müssen alte Elektro- und Elektronikgeräte getrennt entsorgt werden. Sie leisten einen Beitrag zum Umweltschutz, wenn Sie das Altgerät nicht in den Hausmüll werfen. 

1.9 Hinweis für medizinische Geräte

Das Telefon arbeitet mit einer sehr geringen Sendeleistung. Diese geringe Sendeleistung schließt eine gesundheitliche Gefährdung nach dem derzeitigen Stand von Forschung und Technik aus. Es hat sich aber gezeigt, dass eingeschaltete tragbare Telefone medizinische Geräte beeinflussen können. Benutzen Sie das Telefon deshalb nicht in der Nähe von medizinischen Geräten. Eine Beeinflussung von Herzschrittmachern durch DECT-Telefone ist bisher nicht festgestellt worden, kann jedoch nicht völlig ausgeschlossen werden. DECT-Telefone können in Hörgeräten einen unangenehmen Brummtönen verursachen.

1.10 Temperatur und Umgebungsbedingungen

Das Telefon ist für den Betrieb in geschützten Räumen mit einem Temperaturbereich von 10 °C bis 30 °C ausgelegt. Die Basisstation darf nicht in Feuchträumen wie Bad oder Waschküche aufgestellt werden. Vermeiden Sie die Nähe zu Wärmequellen wie Heizkörpern und setzen Sie das Gerät keiner direkten Sonnenbestrahlung aus. Verwenden Sie das Mobilteil nicht in explosionsgefährdeten Bereichen. Vermeiden Sie Belastungen durch Rauch, Staub, Erschütterungen, Chemikalien, Feuchtigkeit, Hitze oder direkte Sonneneinstrahlung.

1.11 Reinigung und Pflege

Reinigen Sie die Gehäusoberflächen mit einem trockenen, weichen und fusselreifen Tuch. Verwenden Sie keine Reinigungsmittel oder aggressiven Lösungsmittel. Außer einer gelegentlichen Gehäusereinigung ist keine weitere Pflege erforderlich. Die GummifüÙe der Basisstation sind nicht gegen alle Reinigungsmittel beständig. Der Hersteller kann daher nicht für evtl. Schäden an Möbeln o. Ä. haftbar gemacht werden.

2 Leistungsmerkmale

2.1 Telefon

- Digitaler DECT/GAP Standard
- Bis zu 10 Stunden Dauergespräch - bis zu 85 Stunden Stand-by
- SMS senden und empfangen
- Sprachverschlüsselung für hohe Sicherheit
- Tonwahlverfahren (MFV)
- Hervorragende Darstellung durch beleuchtetes Display
- Einfache Bedienung durch grafische Menüführung
- Rufnummernanzeige im Display (CLIP)
- Anruferliste mit 50 Speicherplätzen für erhaltene/entgangene Anrufe
- Wahlwiederholung der letzten 20 Rufnummern
- Telefonbuch mit 150 Speicherplätzen inklusive Namen
- 24-Stunden-Uhr mit Weck-/Alarmfunktion im Mobilteil integriert
- Anzeige der Gesprächsdauer
- Durch weitere GAP-fähige DECT-Mobilteile erweiterbar
- Multilinkbetrieb mit bis zu fünf Mobilteilen
- Interne Gespräche zwischen zwei Mobilteilen möglich
- Konferenzgespräche zwischen zwei Mobilteilen und einem externen Teilnehmer
- Weiterleiten von Gesprächen zwischen den Mobilteilen
- Mehrfach einstellbare Tonrufmelodie für das Mobilteil und die Basisstation
- VIP-Ruf (Melodien-Zuordnung)
- Geeignet für Zusatzdienste der Swisscom (Hook-Flash) - Nebenstellentauglich
- Stummschaltung
- Tastatursperre
- Freisprechfunktion am Mobilteil

DECT: **D**igital **E**uropean **C**ordless **T**elephone = Standard für kabellose Telefone.

GAP: **G**eneric **A**ccess **P**rofile = Standard für das Zusammenwirken von Mobilteilen und Basisstationen anderer Hersteller.

3 Bedienelemente

3.1 Mobilteil

1. Grafisches Farb-Display
2. Gewählte Nummer / Lautstärke + / Menü-Navigation aufwärts
3. Telefonbuch
4. Gespräch beenden / Ein / Aus
5. Entgangene Anrufe / Lautstärke - / Menü-Navigation abwärts
6. Tastensperre
7. Intern- und Konferenzgespräche
8. R-Signaltaste
9. Gespräch führen / Freisprechen
10. Menütaste / Auswahltaste

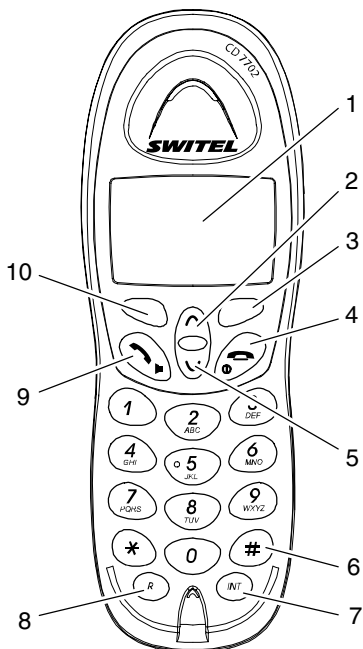

3.2 Basisstation/Ladestation

11. Paging-Taste (Mobilteil suchen)
12. LED Gesprächs- und Netzanzeige
13. LED Ladekontrollleuchte (Basisstation)
14. LED Ladekontrollleuchte (Ladestation)

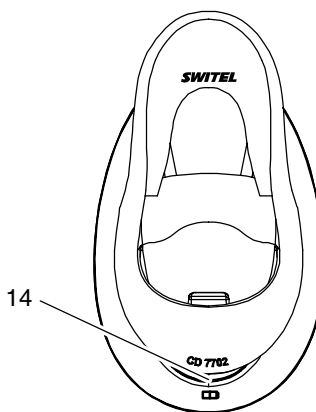
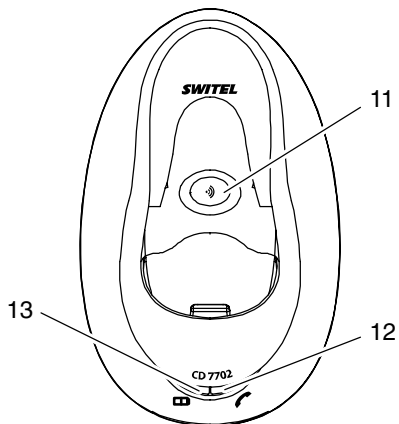

- Inbetriebnahme -

4 Inbetriebnahme

4.1 Sicherheitshinweise



Achtung: Lesen Sie vor der Inbetriebnahme unbedingt die allgemeinen Hinweise am Anfang dieser Bedienungsanleitung.

4.2 Verpackungsinhalt prüfen

Zum Lieferumfang gehören:

eine Basisstation und eine Ladestation	ein Telefonanschlusskabel
zwei Mobilteile	vier Standard-Akkus
zwei Netzteile	eine Bedienungsanleitung

4.3 Basisstation anschließen

Stellen Sie die Basisstation in der Nähe Ihrer Telefonanschlussdose und einer Netzsteckdose auf. Verwenden Sie nur die mitgelieferten Komponenten.

1. Stecken Sie den kleinen Stecker des Netzteils in die entsprechende Buchse auf der Unterseite der Basisstation.

Hinweis: Sie können die Stecker nicht falsch anschließen, weil

Stecker und Buchsen konstruktiv gegen eine Verpolung geschützt sind. Die Stecker müssen hörbar in die Buchsen an der Basisstation einrasten.

2. Stecken Sie den kleinen Stecker des Telefonanschlusskabels in die entsprechende Buchse auf der Unterseite der Basisstation.
3. Führen Sie beide Kabel auf der Unterseite der Basisstation im vorgesehenen Kabelkanal zur Rückseite.
4. Stecken Sie das Netzteil in eine vorschriftsmäßig installierte 230 Volt Netzsteckdose. Das Netzteil der Basisstation muss immer angeschlossen sein.
5. Verbinden Sie das beiliegende Telefonanschlusskabel mit der Telefonsteckdose.

4.4 Ladestation anschließen

Stellen Sie die Ladestation für das zweite Mobilteil in der Nähe einer Netzsteckdose auf. Stecken Sie das Steckernetzteil in eine vorschriftsmäßig installierte 230 Volt Netzsteckdose.

4.5 Standard-Akkus einsetzen

Um die mitgelieferten wiederaufladbaren Standard-Akkus in das Mobilteil einzulegen, drücken Sie auf den oberen Rand des Batteriefachdeckels. Schieben Sie den Deckel nach unten. Legen Sie nun die Standard-Akkus ein. Achten Sie dabei auf die richtige Polung. Schließen Sie das Batteriefach.

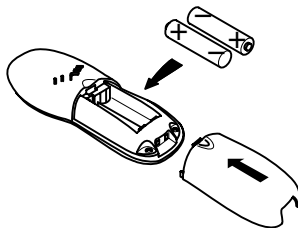

4.6 Aufladen der Standard-Akkus

Stellen Sie die Mobilteile mit dem Display nach vorne für mindestens 14 Stunden auf die Basisstation bzw. die Ladestation. An der Basisstation und Ladestation leuchten die Ladekontrollleuchten. Bei nicht richtig geladenen Standard-Akkus kann es zu Fehlfunktionen des Telefons kommen.

Die wiederaufladbaren Standard-Akkus Ihres Mobilteils besitzen eine Standby-Zeit bei Zimmertemperatur von max. 85 Stunden. Die maximale Gesprächsdauer beträgt 10 Stunden.

Der aktuelle Akkuladezustand wird im Display angezeigt:

Voll	Halb	Schwach	Leer

4.7 Tonwahl - MFV

Dieses Telefon benutzt das Wahlverfahren der Tonwahl - MFV (Mehrfrequenzwahlverfahren). Vorteile dieses modernen Wahlverfahrens sind eine kurze Verbindungsaufbauzeit, die Fernsteuerungsmöglichkeit für Geräte wie z. B. Anrufbeantworter sowie die Nutzung weiterer ISDN-Dienstmerkmale.

5 Bedienung





5.1 Das Display

Das Display zeigt Ihnen alle wichtigen Funktionen mit verschiedenen Symbolen an. Es ist mit einer automatischen Hintergrundbeleuchtung ausgestattet, die das Display bei jedem Tastendruck für ca. 30 Sekunden beleuchtet.

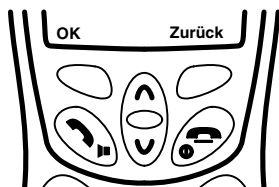
5.2 Die Navigation mit den Tasten



Alle Funktionen sind über ein sehr benutzerfreundliches, grafisches Menü zu erreichen. Achten Sie immer auf die menübegleitenden Texte im Display, dann werden Sie sicher und intuitiv navigieren. Alle Beschreibungen in dieser Bedienungsanleitung gehen davon aus, dass sich das Mobilteil im Ruhezustand befindet. Im Ruhezustand sehen Sie im Display ein Strandfoto und den Namen des Mobilteils (Voreinstellung "Studio 1"). Den Ruhezustand erreichen Sie durch Drücken der Taste .





Taste	Beschreibung
	Die aktuelle Funktion wird direkt über der Taste im Display links angezeigt. Drücken Sie diese Taste um die Funktion auszuwählen. Im Ruhezustand öffnet die Taste das Menü.
	Die aktuelle Funktion wird direkt über der Taste im Display rechts angezeigt. Drücken Sie diese Taste um die Funktion auszuwählen. Im Ruhezustand öffnet die Taste das Telefonbuch.
	Drücken Sie diese Taste, um im Menü aufwärts zu blättern.
	Drücken Sie diese Taste um im Menü abwärts zu blättern.
	Drücken Sie diese Taste, um an jeder Stelle im Menü den Vorgang abzubrechen. Das Mobilteil kehrt zurück in den Ruhezustand.

5.3 Anruf führen und beenden

1. Geben Sie die Rufnummer (max. 25 Stellen) ein.

Hinweis: Kurzes Drücken der Taste  löscht die zuletzt eingegebene Zahl. Langes Drücken der Taste  löscht die Rufnummer komplett. Das Gerät geht in den Ruhezustand.

2. Drücken Sie die Taste  und die gewünschte Verbindung wird hergestellt.

Hinweis: Sie können auch zuerst die Taste  drücken und dann die Rufnummer eingeben. Eine Korrektur einzelner Zahlen der Rufnummer, wie oben beschrieben, ist bei dieser Form des Gesprächsaufbaus nicht möglich.



3. Zum Beenden des Gespräches drücken Sie die Taste  oder stellen Sie das Mobilteil in die Basisstation.

5.4 Anruf annehmen

Ihr Mobilteil und die Basisstation klingeln. Nehmen Sie das Mobilteil von der Basisstation, dadurch wird die Verbindung hergestellt. Die LED Gesprächsanzeige an der Basisstation blinkt.

Hinweis: Ist die automatische Gesprächsannahme deaktiviert, stellen Sie durch Drücken der Taste  am Mobilteil die Verbindung her.

5.5 Zwei externe Anrufe entgegennehmen



Sie werden durch Signaltöne darauf hingewiesen (Anklopfen), dass während des Telefonierens ein weiterer Anruf eingeht. Die Rufnummer des zweiten Anrufers wird im Display angezeigt. Sie können mit der Tastenfolge " "" zwischen beiden Teilnehmern hin- und herwechseln. Ein Teilnehmer wird, während Sie mit dem anderen Teilnehmer sprechen, gehalten.

Hinweis: Zur Nutzung von Zusatzdiensten der Swisscom müssen Sie die Flash-Zeit auf 300 ms einstellen (siehe Kapitel "14.4 Flashzeiten einstellen").





Achtung: Die Rufnummernanzeige und das Anklopfen ist ein optionaler Service Ihres Netzbetreibers. Ihr Telefon zeigt die Rufnummern im Display an, wenn Ihr Netzbetreiber diesen Service anbietet. Fragen Sie Ihren Netzbetreiber nach weiteren Informationen.

5.6 Freisprechen

1. Drücken Sie während eines Gesprächs erneut die Taste . Jetzt hören Sie den Gesprächspartner über den Lautsprecher des Mobilteils.
2. Drücken Sie erneut die Taste , um das Freisprechen zu beenden.

5.7 Rufnummern aus dem Telefonbuch wählen

Nachdem Sie einige Rufnummern im Telefonbuch gespeichert haben (siehe "Rufnummer in das Telefonbuch eingeben" Kapitel 8.1), können Sie diese sehr schnell und einfach abrufen.

1. Drücken Sie die Taste . Das Display zeigt nun in alphabetischer Reihenfolge die Telefonbucheinträge.
2. Mit der Taste  oder  können Sie nun einen Telefonbucheintrag auswählen.

Hinweis: Um einen Eintrag direkt auszuwählen, drücken Sie die Taste, die dem Anfangsbuchstaben des Eintrages entspricht. Um z. B. den Namen "Peters" direkt auszuwählen, drücken Sie einmal die Taste .



3. Drücken Sie nun die Taste  und die gewünschte Rufnummer wird automatisch gewählt.

5.8 Anzeige der Gesprächsdauer

Während eines Gesprächs wird nach 15 Sekunden im Display die Gesprächsdauer in Minuten und Sekunden sowie die Rufnummer des Gesprächspartners angezeigt.

5.9 Einstellen der Hörerlautstärke



Ist Ihnen die Hörerlautstärke zu leise oder zu laut, können Sie diese Ihren Bedürfnissen anpassen.

Drücken Sie während eines Gesprächs die Taste  oder , um die Lautstärke in fünf Stufen anzupassen.

5.10 Wahlwiederholung

Siehe "Gewählte Nummern (Wahlwiederholung)" Kapitel 10.4.

5.11 Mobilteil stummschalten

Wenn Sie die Taste  während eines Telefongesprächs drücken, schalten Sie das Mikrofon des Mobilteils stumm. Im Display erscheint die Anzeige "Stumm ein". Dadurch können Sie mit einer dritten Person sprechen, ohne dass der Gesprächspartner Sie hört. Der Lautsprecher im Mobilteil bleibt eingeschaltet, sodass Sie den Gesprächspartner weiterhin hören. Wenn Sie die Taste  erneut drücken, wird die Stummschaltung aufgehoben.

5.12 Mobilteil ein-/ausschalten

Zum Ein-/Ausschalten des Mobilteils drücken Sie für 2 Sek. die Taste . Das Display erlischt bzw. schaltet sich wieder ein.

5.13 Mobilteil suchen (Paging)

Wenn Sie Ihr Mobilteil verlegt haben, können Sie es mit Hilfe der Basis suchen.

1. Drücken Sie an der Basis die Paging-Taste . Alle an der Basis angemeldeten Mobilteile klingeln.
2. Zum Beenden der Suche drücken Sie an der Basisstation erneut die Paging-Taste oder eine beliebige Taste am Mobilteil.



5.14 Tastensperre

Tragen Sie das Mobilteil bei sich, können Sie die Tastatur sperren, damit nicht ungewollt Tasten gedrückt werden. Trotz eingeschalteter Tastensperre werden eingehende Gespräche entgegengenommen.

5.14.1 Tastensperre einschalten

Drücken Sie am Mobilteil für drei Sekunden die Taste .
Im Display erscheint die Anzeige "Tastensperre" und das Symbol .

5.14.2 Tastensperre ausschalten

Um die Tastensperre auszuschalten, drücken Sie die Taste  und bestätigen Sie dies durch nochmaliges Drücken der Taste .

5.15 Hinweise zur Reichweite

Die Reichweite des Mobilteils beträgt ca. 50 Meter in geschlossenen Räumen und ca. 300 Meter im Freien. Bei einer guten Verbindung zur Basisstation erscheint im Display das Symbol .

Hinweis: Haben Sie sich zu weit von der Basisstation entfernt, blinkt das Symbol  und Sie hören einen Warnton. Nähern Sie sich der Basisstation, sonst wird das Gespräch unterbrochen.

6 Nebenstellenanlagen / Zusatzdienste

Die Taste  Ihres Telefons können Sie an Nebenstellenanlagen und bei der Verwendung der Zusatzdienste der Swisscom nutzen.

6.1 R-Taste an Nebenstellenanlagen

Ist Ihr Telefon an einer Nebenstellenanlage angeschlossen, können Sie über die Taste  alle Möglichkeiten, wie z. B. Anrufe weiterleiten, automatischen Rückruf usw., nutzen. An einer Nebenstellenanlage wird eine Flash-Zeit von 100 ms benötigt (Einstellung siehe Kapitel 14.4). Ob Ihr Telefon an Ihrer Nebenstellenanlage einwandfrei funktioniert, erfahren Sie bei dem Händler, bei dem die Anlage gekauft wurde.

6.2 R-Taste und die Zusatzdienste der Swisscom

Ihr SWITEL-Telefon unterstützt die wichtigsten Zusatzdienste der Swisscom (z. B. Makeln, Anklopfen, Dreier-Konferenz). Die Zusatzdienste arbeiten mit einer Flash-Zeit von 300 ms (Einstellung siehe Kapitel 14.4). Zur Freischaltung der Zusatzdienste wenden Sie sich bitte an die Swisscom.

6.3 Wahlpause

Bei Nebenstellenanlagen ist es erforderlich, eine bestimmte Nummer zu wählen (z. B. "9" oder "0"), um ein Freizeichen für eine Amtsleitung zu bekommen. Bei wenigen älteren Nebenstellenanlagen dauert es einige Zeit, bis das Freizeichen zu hören ist. Speziell für diese Nebenstellenanlagen kann nach der Amtsholung eine automatische Pause eingefügt werden, so dass Sie direkt weiter wählen können, ohne das Freizeichen abzuwarten.

Drücken Sie zwischen der Amtskennziffer und der Rufnummer einmal die Taste  für ca. 2 Sekunden. Im Display erscheint die Anzeige "P". Zwischen Amtskennziffer und Rufnummer wird eine Pause von 3 Sekunden eingefügt.

Hinweis: Die Pause kann auch bei der Eingabe von Rufnummern in das Telefonbuch eingegeben werden.

- Menüstruktur -

7 Menüstruktur

Hier finden Sie die Menüstruktur Ihres Telefons. Im Ruhezustand öffnen Sie die Menüauswahl durch Drücken der Taste . Aus Gründen der Übersichtlichkeit sind nicht immer alle Ebenen jedes Menüpunktes dargestellt.

SMS	Nachricht schreiben	Optionen	Senden an	Suchen
			Speichern	
			Symbol einfügen	
			Benutzername	
	Eingang	Lesen	Optionen	Antworten
				Weiterleiten
				Löschen
	Ausgang	Lesen	Optionen	Bearbeiten
				Senden an
				Löschen
				Benutzername
	Nachricht löschen	Eingang		
		Ausgang		
		Alle Nachrichten		
	Einstellungen	Service Center	Empfangs-SC	
			Sende-SC	
		Apparatnummer		
		Nachrichtenton		
		Benutzer		
Anruferlisten	Eingegangene Anrufe	Optionen	Löschen	
			Details anzeigen	
			Nr. einfügen	
	Entgangene Anrufe	Optionen	Löschen	
			Details anzeigen	
			Nr. einfügen	
	Gewählte Nummern	Optionen	Löschen	
			Details anzeigen	
			Nr. einfügen	
	Anruferliste löschen	Eingegangene Anrufe		
		Entgangene Anrufe		
		Gewählte Nr.		
		Alle Anrufe		

- Menüstruktur -

Mobilteil	Rufton	Externe Anrufe
		Interne Anrufe
	Ruftonlautstärke	
	Name Mobilteil	
	Sprache	
	Menüfarbe	
	Auto. Gesprächsanna	
	Zugangskode	

Basis-Einstellungen	Rufton Basis		
	Lautstärke Basis		
	Vorrang Mobilteil	Alle Mobilteile	
		Mobilteil auswählen	Mobilteil 1-5
			Ruftöne 2
	Flashzeiten		Ruftöne 4
			Ruftöne 6
	System-PIN (Voreinstellung: 0000)		

Zeiteinstellung	Wecker	Ein/Aus	Einmalig
		Weckton einstellen	Weckton 1-4
	Zeit und Datum	Datum	Zeit
			Täglich
			Aus

Anmeldung	Mobilteil anmelden	Basis 1	System-PIN (Voreinstellung: 0000)
		Basis 2	
		Basis 3	
		Basis 4	
	Basis auswählen	Automatik	
		Basis 1	
		Basis 2	
		Basis 3	
		Basis 4	
	Mobilteil abmelden	System-PIN (Voreinstellung: 0000)	





8 Das Telefonbuch

Im Ruhezustand gelangen Sie durch Drücken der Taste  in das Menü des Telefonbuches. In das Telefonbuch können 150 Rufnummern mit dazugehörigen Namen gespeichert werden. Für die Eingabe eines Namens haben Sie 16 Zeichen zur Verfügung. Die maximale Länge einer Rufnummer beträgt 20 Zeichen.



8.1 Rufnummer in das Telefonbuch eingeben

1. Drücken Sie die Taste . Im Display wird das Telefonbuch geöffnet.

Hinweis: Wenn Sie den ersten Eintrag im Telefonbuch erstellen, fahren Sie jetzt mit Schritt 4 fort.

2. Drücken Sie die Taste .
3. Wählen Sie mit der Taste  oder  im Display die Option "Nr. Einfügen".
4. Drücken Sie die Taste . Das Display zeigt die Meldung "Name"
5. Geben Sie nun den zugehörigen Namen über das Zahlenfeld ein.





Hinweis: Texteingabe siehe 8.1.1.

6. Drücken Sie die Taste . Das Display zeigt die Meldung "Nummer"
7. Geben Sie die gewünschte Rufnummer über das Zahlenfeld ein.
8. Drücken Sie die Taste . Der Eintrag wird im Display bestätigt.
9. Möchten Sie weitere Rufnummern speichern, wiederholen Sie Punkt 3 bis 9.
10. Durch Drücken der Taste  kehrt das Mobilteil zurück in den Ruhezustand.

8.1.1 Texteingabe



Zur Eingabe von Text sind die Zahlentasten mit Buchstaben beschriftet. Durch mehrmaliges Drücken der entsprechenden Taste können Buchstaben sowie Zahlen eingegeben werden.

Beispiel: Sie möchten den Namen "Peter" eingeben.

Drücken Sie: 1 x Taste , 2 x Taste , 1 x Taste , 2 x Taste , 3 x Taste 

- Um ein Leerzeichen einzugeben, drücken Sie einmal die Taste .
- Um den gleichen Buchstaben zweimal einzugeben, drücken Sie den entsprechenden Buchstaben und warten Sie dann, bis der Cursor automatisch eine Stelle weiter springt.



Hinweis: Falsche Eingaben können mit der Taste  gelöscht werden.

Um den Cursor nach links oder rechts zu bewegen, drücken Sie die Taste  oder .





8.1.2 Hinweise zum Telefonbuch

- Geben Sie bei allen Rufnummern immer die Vorwahl mit ein, damit das Telefon auch eingehende Ortsgespräche einem Telefonbucheintrag zuordnen kann.
- Ist die Speicherkapazität von 150 Rufnummern erreicht, zeigt das Display beim nächsten Speichern eine entsprechende Meldung. Um wieder Platz zu schaffen, müssen Sie vorhandene Einträge löschen.



8.2 Details des Eintrages anzeigen

1. Drücken Sie die Taste . Im Display wird das Telefonbuch geöffnet.
2. Wählen Sie mit der Taste  oder  im Display den gewünschten Eintrag.





Hinweis: Um einen Eintrag direkt auszuwählen, drücken Sie die Taste, die dem Anfangsbuchstaben des Eintrages entspricht. Um z. B. den Namen "Peters" direkt anzuwählen, drücken Sie einmal die Taste .

3. Drücken Sie die Taste .
4. Wählen Sie mit der Taste  oder  im Display die Option "Details anzeigen".
5. Drücken Sie die Taste . Das Display zeigt den Namen und die Rufnummer an.
6. Durch Drücken der Taste  kehren Sie jeweils um eine Menüebene zurück.





8.3 Gespeicherte Einträge im Telefonbuch ändern

1. Drücken Sie die Taste . Im Display wird das Telefonbuch geöffnet.
2. Wählen Sie mit der Taste  oder  im Display den gewünschten Eintrag.



Hinweis: Um einen Eintrag direkt auszuwählen, drücken Sie die Taste, die dem Anfangsbuchstaben des Eintrages entspricht. Um z. B. den Namen "Peters" direkt anzuwählen, drücken Sie einmal die Taste .

3. Drücken Sie die Taste .
4. Wählen Sie mit der Taste  oder  im Display die Option "Nr. ändern".
5. Drücken Sie die Taste . Im Display wird der Name angezeigt. Bei Bedarf ändern Sie den Namen oder fahren Sie fort mit Schritt 6.







Hinweis: Hinweise zur Namenseingabe unter 8.1.1.

6. Drücken Sie die Taste . Im Display wird die Nummer angezeigt. Bei Bedarf ändern Sie die Nummer oder fahren Sie fort mit Schritt 7.
7. Drücken Sie die Taste . Die Änderung wird im Display bestätigt.
8. Durch einmaliges Drücken der Taste  kehren Sie zurück zum Telefonbuch, um weitere Einträge zu bearbeiten.
9. Durch Drücken der Taste  kehren Sie jeweils um eine Menüebene zurück.







8.4 Eintrag aus dem Telefonbuch löschen

1. Drücken Sie die Taste . Im Display wird das Telefonbuch geöffnet.
2. Wählen Sie mit der Taste  oder  im Display den gewünschten Eintrag.

Hinweis: Um einen Eintrag direkt auszuwählen, drücken Sie die Taste, die dem Anfangsbuchstaben des Eintrages entspricht. Um z. B. den Namen "Peters" direkt auszuwählen, drücken Sie einmal die Taste .

3. Drücken Sie die Taste .
4. Wählen Sie mit der Taste  oder  im Display die Option "Nr. löschen".
5. Drücken Sie die Taste . Im Display erscheint die Abfrage zum Löschen des Eintrages.
6. Drücken Sie die Taste . Das Löschen wird im Display bestätigt.
7. Durch Drücken der Taste  kehrt das Mobilteil zurück in den Ruhezustand.



8.5 Alle Einträge aus dem Telefonbuch löschen

1. Drücken Sie die Taste . Im Display wird das Telefonbuch geöffnet.
2. Drücken Sie die Taste .
3. Wählen Sie mit der Taste  oder  im Display die Option "Rubrik löschen".
4. Drücken Sie die Taste . Im Display erscheint die Abfrage zum Löschen aller Einträge.
5. Drücken Sie die Taste . Das Löschen wird im Display bestätigt. Bei Bedarf können Sie neue Einträge in das Telefonbuch eingeben.
6. Durch Drücken der Taste  kehrt das Mobilteil zurück in den Ruhezustand.









8.6 VIP-Ruf (Ruftonzuordnung)

Telefonbucheinträgen von Anrufern, die Ihnen besonders wichtig sind, können Sie eine bestimmte Ruftonmelodie zuweisen. Dadurch erkennen Sie bereits an der Ruftonmelodie, wer Sie anruft.



8.6.1 Ruftonmelodie zuweisen

1. Drücken Sie die Taste . Im Display wird das Telefonbuch geöffnet.
2. Wählen Sie mit der Taste  oder  im Display den gewünschten Eintrag.









Hinweis: Um einen Eintrag direkt auszuwählen, drücken Sie die Taste, die dem Anfangsbuchstaben des Eintrages entspricht. Um z. B. den Namen "Peters" direkt auszuwählen, drücken Sie einmal die Taste .

3. Drücken Sie die Taste .
4. Wählen Sie mit der Taste  oder  im Display die Option "Rufton".
5. Drücken Sie die Taste . Im Display erscheinen mehrere Melodien zur Auswahl.
6. Wählen Sie mit der Taste  oder  im Display die gewünschte Melodie.
7. Drücken Sie die Taste . Die Zuweisung wird im Display bestätigt.
8. Durch Drücken der Taste  kehren Sie jeweils um eine Menüebene zurück.

8.6.2 Ruftonzuweisung ausschalten

1. Drücken Sie die Taste . Im Display wird das Telefonbuch geöffnet.
2. Wählen Sie mit der Taste  oder  im Display den gewünschten Eintrag.

Hinweis: Um einen Eintrag direkt auszuwählen, drücken Sie die Taste, die dem Anfangsbuchstaben des Eintrages entspricht. Um z. B. den Namen "Peters" direkt auszuwählen, drücken Sie einmal die Taste .

3. Drücken Sie die Taste . Im Display werden mehrere Optionen angezeigt.
4. Wählen Sie mit der Taste  oder  im Display die Option "Rufton".
5. Drücken Sie die Taste . Im Display erscheinen mehrere Melodien zur Auswahl und die Option "Aus"
6. Wählen Sie mit der Taste  oder  im Display die Option "Aus".
7. Drücken Sie die Taste . Die Zuweisung wird im Display bestätigt.
8. Durch Drücken der Taste  kehren Sie jeweils um eine Menüebene zurück.

9 SMS-Nachrichten

Allgemeine Voraussetzungen

Die beliebte Kommunikation mit kurzen Nachrichten (SMS) ist auch im Festnetz möglich. Sie können mit Ihrem Telefon Textmeldungen (SMS) senden und empfangen. Damit Sie SMS-Textmeldungen senden und empfangen können, müssen einige Voraussetzungen vorhanden sein.

- Ihr Telefonanschluss muss über das Leistungsmerkmal CLIP (Calling Line Identification Presentation) verfügen. Vergewissern Sie sich bei Ihrem Telefonnetzbetreiber, dass diese Leistungsmerkmale an Ihrem Telefonanschluss freigeschaltet sind. Dieses Leistungsmerkmal kann kostenpflichtig sein und muss ggf. bei Ihrem Telefonnetzbetreiber (z. B. Swisscom unter der Rufnummer 0800800800) beantragt werden.
- 0190er Rufnummern dürfen an Ihrem Festnetzanschluss nicht gesperrt sein.
- Um den SMS-Dienst zu nutzen, muss dieser ggf. bei Ihrem Telefonnetzbetreiber aktiviert werden.

Hinweis: Bei Call-by-Call-Verbindungen ist der SMS-Versand derzeit nicht möglich.

- Das Senden von SMS-Nachrichten ist kostenpflichtig.
- Nutzt der Empfänger im Festnetz keinen SMS-Dienst oder kann sein Telefon generell keine Textnachrichten empfangen, wird die SMS automatisch als Sprachmeldung zugestellt, d. h. am Telefon vorgelesen.
- Die Kostenberechnung erfolgt über den Telefonnetzbetreiber.

Durch die ständige Weiterentwicklung können sich die hier gemachten Angaben bereits wieder geändert haben. Aktuelle Informationen erhalten Sie über die jeweiligen Internetseiten oder Servicenummern der Netzbetreiber.

9.1 Service Center

Die Verteilung aller SMS-Nachrichten erfolgt über ein Service Center. Die "Swisscom", "cablecom" und weitere Telefonnetzbetreiber bieten diesen Service an. Ihr SWITEL Telefon ist für den Betrieb (Senden und Empfangen von SMS-Nachrichten) bei "Swisscom" und "cablecom" vorbereitet.

Service Center der "Swisscom"

- Die Nummer des Service Center der "Swisscom" lautet 0622 100 000.
- Die SMS-Funktion von "Swisscom" ist bereits für Sie aufgeschaltet. Es ist keine weitere Anmeldung erforderlich.

















Service Center der "cablecom"

- Die Nummer des Service Center von "cablecom" lautet 0435 375 370.
- Die SMS-Funktion von "cablecom" ist bereits für Sie aufgeschaltet. Es ist keine weitere Anmeldung erforderlich.

In Ihrem Mobilteil können zwei SMS-Rufnummern einprogrammiert werden: eine Rufnummer für das Senden und eine Rufnummer für das Empfangen von SMS-Nachrichten. Wenn Sie den Service eines anderen Anbieters nutzen möchten, müssen Sie dessen Rufnummer(n) in das Mobilteil einprogrammieren. Dazu gehen Sie vor wie in 9.1.1 beschrieben.





Hinweis: Die Anmeldeverfahren der einzelnen Anbieter variieren. Bitte erfragen Sie beim Anbieter Ihrer Wahl die erforderliche Rufnummer und die Vorgehensweise zur Freischaltung des SMS-Dienstes.

9.1.1 Sende-/Empfangsnummer eingeben



1. Drücken Sie die Taste .
2. Wählen Sie mit der Taste  oder  im Display den Menüpunkt "SMS".
3. Drücken Sie die Taste .
4. Wählen Sie mit der Taste  oder  im Display die Option "Einstellungen".
5. Drücken Sie die Taste .
6. Wählen Sie mit der Taste  oder  im Display die Option "Service Center".
7. Drücken Sie die Taste .
8. Wählen Sie mit der Taste  oder  im Display die Option "Empfangs-SC". Geben Sie die Rufnummer ein, die Ihnen der Anbieter Ihrer Wahl mitgeteilt hat.
9. Drücken Sie die Taste .
10. Wählen Sie mit der Taste  oder  im Display die Option "Sende-SC". Geben Sie die Rufnummer ein, die Ihnen der Anbieter Ihrer Wahl mitgeteilt hat.
11. Drücken Sie die Taste .
12. Durch Drücken der Taste  kehren Sie jeweils um eine Menüebene zurück.

9.2 Schreiben und versenden







Hinweis: Das Versenden einer SMS-Nachricht von einer Nebenstellenanlage ist nicht möglich. Zum Versenden der SMS-Nachricht muss der "Zugangskode" deaktiviert sein (siehe Kapitel 11.7).



1. Drücken Sie die Taste .
2. Wählen Sie mit der Taste  oder  im Display den Menüpunkt "SMS".
3. Drücken Sie die Taste .

- SMS Nachrichten -





4. Wählen Sie mit der Taste  oder  im Display die Option "Nachricht schreiben".
5. Drücken Sie die Taste . Geben Sie nun den Text über das Zahlenfeld ein. Es sind bis zu 160 Zeichen möglich.

Hinweis: Texteingabe siehe 8.1.1.

Hinweis: Um ein Symbol einzufügen, drücken Sie während der Texteingabe die Taste . Wählen Sie mit der Taste  oder  im Display die Option "Symbol einfügen". Drücken Sie die Taste . Wählen Sie mit der Taste  oder  das gewünschte Symbol. Drücken Sie die Taste . Das Display springt wieder zur Texteingabe. Vervollständigen Sie Ihren Text.











6. Drücken Sie die Taste .
7. Wählen Sie mit der Taste  oder  im Display die Option "Senden an".

Hinweis: Wenn Sie die SMS-Nachricht zu einem späteren Zeitpunkt versenden möchten, wählen Sie unter Schritt 7 die Option "Speichern". Ihre SMS-Nachricht wird in der Liste "Ausgang" gespeichert.

8. Drücken Sie die Taste .
9. Geben Sie die Rufnummer des Empfängers ein.
Ist der Empfänger in Ihrem Telefonbuch gespeichert, drücken Sie die Taste . Wählen Sie mit der Taste  oder  den gewünschten Empfänger und drücken dann die Taste . Weiter mit Schritt 10.

10. Drücken Sie die Taste . Im Display wird das Senden bestätigt.





9.3 **Gespeicherte SMS-Nachricht versenden**







1. Drücken Sie zweimal die Taste .
2. Wählen Sie mit der Taste  oder  im Display die Option "Ausgang".
3. Drücken Sie die Taste .
4. Wählen Sie mit der Taste  oder  im Display die gewünschte SMS-Nachricht.
5. Drücken Sie zweimal die Taste .
6. Wählen Sie mit der Taste  oder  im Display die Option "Senden an".
7. Drücken Sie die Taste .
8. Geben Sie die Rufnummer des Empfängers ein und drücken dann die Taste .

9.4 **Lesen und beantworten**









Sobald eine SMS-Nachricht empfangen wird, hören Sie einen Signalton und das Display zeigt den Eingang einer neuen Nachricht an.

1. Drücken Sie die Taste . Im Display wird die Eingangsliste geöffnet. SMS-Nachrichten, die noch nicht gelesen wurden, sind mit einem Stern gekennzeichnet.















Hinweis: Möchten Sie eine bereits gelesene SMS-Nachricht beantworten, drücken Sie zweimal die Taste , wählen Sie mit der Taste  oder  im Display die Option "Eingang" und drücken die Taste . Weiter mit Schritt 2.

2. Wählen Sie mit der Taste  oder  im Display die gewünschte SMS-Nachricht aus.
3. Drücken Sie die Taste .
4. Drücken Sie die Taste .
5. Wählen Sie mit der Taste  oder  im Display die Option "Antworten". Wählen Sie die Option "Weiterleiten", um die SMS-Nachricht weiterzuleiten. Zum Weiterleiten der SMS-Nachricht fahren Sie fort mit Schritt 8.
6. Drücken Sie die Taste . Geben Sie nun den Text über das Zahlenfeld ein. Es sind bis zu 160 Zeichen möglich.

















Hinweis: Texteingabe siehe 8.1.1.

7. Drücken Sie die Taste .
8. Wählen Sie mit der Taste  oder  im Display die Option "Senden an".
9. Drücken Sie die Taste .
10. Geben Sie die Rufnummer des Empfängers ein.
Ist der Empfänger in Ihrem Telefonbuch gespeichert, drücken Sie die Taste . Wählen Sie mit der Taste  oder  den gewünschten Empfänger und drücken dann die Taste .
11. Drücken Sie die Taste . Im Display wird das Senden bestätigt.

9.5 **Nachrichtenton Ein/Aus**















1. Drücken Sie die Taste .
2. Wählen Sie mit der Taste  oder  im Display den Menüpunkt "SMS".
3. Drücken Sie die Taste .
4. Wählen Sie mit der Taste  oder  im Display die Option "Einstellungen".
5. Drücken Sie die Taste .
6. Wählen Sie mit der Taste  oder  im Display die Option "Nachrichtenton".
7. Drücken Sie die Taste .
8. Wählen Sie mit der Taste  oder  im Display nach Bedarf die Option "Ein" oder "Aus".
9. Drücken Sie die Taste .
10. Durch Drücken der Taste  kehren Sie jeweils um eine Menüebene zurück.

9.6 Nachrichtenton einstellen (Morseton, Diskret, Polyphon)

1. Drücken Sie die Taste .
2. Wählen Sie mit der Taste  oder  im Display den Menüpunkt "SMS".
3. Drücken Sie die Taste .
4. Wählen Sie mit der Taste  oder  im Display die Option "Einstellungen".
5. Drücken Sie die Taste .
6. Wählen Sie mit der Taste  oder  im Display die Option "Nachrichtenton".
7. Drücken Sie die Taste .
8. Wählen Sie mit der Taste  oder  im Display die Option "Warnton einstellen".
9. Drücken Sie die Taste .
10. Wählen Sie mit der Taste  oder  im Display die gewünschte Tonart.
11. Drücken Sie die Taste . Die Änderung wird im Display bestätigt.









9.7 SMS-Nachricht löschen



Aus den Ordnern "Eingang" und "Ausgang" können einzelne SMS-Nachrichten gelöscht werden.



1. Drücken Sie die Taste .
2. Wählen Sie mit der Taste  oder  im Display den Menüpunkt "SMS".
3. Drücken Sie die Taste .
4. Wählen Sie mit der Taste  oder  im Display die Option "Eingang" oder "Ausgang".
5. Drücken Sie die Taste .
6. Wählen Sie mit der Taste  oder  im Display die gewünschte SMS.
7. Drücken Sie die Taste .
8. Drücken Sie die Taste  und wählen Sie die Option "Löschen".
9. Drücken Sie die Taste .
10. Drücken Sie die Taste  um das Löschen zu bestätigen.
11. Durch Drücken der Taste  kehren Sie jeweils um eine Menüebene zurück.

9.8 Alle SMS-Nachrichten löschen

Alle SMS-Nachrichten die sich in den Listen "Eingang" und "Ausgang" befinden, können komplett gelöscht werden.

1. Drücken Sie die Taste .
2. Wählen Sie mit der Taste  oder  im Display den Menüpunkt "SMS".
3. Drücken Sie die Taste .
4. Wählen Sie mit der Taste  oder  im Display die Option "Nachricht löschen".
5. Drücken Sie die Taste .
6. Wählen Sie mit der Taste  oder  im Display die Option "Alle Nachrichten".

Hinweis: Möchten Sie nur die SMS-Nachrichten im Ordner "Eingang" bzw. "Ausgang" löschen, wählen Sie mit der Taste  oder  im Display die entsprechende Option.

7. Drücken Sie die Taste . Im Display erscheint eine Bestätigungsabfrage.
8. Drücken Sie die Taste . Im Display wird das Löschen bestätigt.
9. Durch Drücken der Taste  kehren Sie jeweils um eine Menüebene zurück.

















9.9 SMS-Postfach

Neben einem bereits vorhandenen, allgemeinen Postfach können Sie vier weitere Postfächer einrichten und durch ein Passwort schützen. Jedes Postfach wird durch einen Benutzernamen und eine Postfach-ID (Durchwahlziffer) gekennzeichnet. Durch diese Funktion ist es Ihnen möglich, SMS-Nachrichten zu erhalten, die nur Sie lesen können.

Hinweis: SMS-Postfächer können Sie nur nutzen, wenn der Netzbetreiber dies unterstützt. Eine Konfigurationsanleitung zur Einrichtung des Postfachbetriebes erfragen Sie bitte bei Ihrem Netzbetreiber.

9.9.1 Postfach/Benutzer hinzufügen

Hinweis: Sie können bis zu vier Benutzer hinzufügen.

1. Drücken Sie die Taste .
2. Wählen Sie mit der Taste  oder  im Display den Menüpunkt "SMS".
3. Drücken Sie die Taste .
4. Wählen Sie mit der Taste  oder  im Display die Option "Einstellungen".
5. Drücken Sie die Taste .
6. Wählen Sie mit der Taste  oder  im Display die Option "Benutzer".
7. Drücken Sie die Taste .
8. Wählen Sie mit der Taste  oder  im Display die Option "Benutzer hinzufügen".
9. Drücken Sie die Taste . Geben Sie über das Zahlenfeld den Benutzernamen ein.
10. Drücken Sie die Taste . Geben Sie über das Zahlenfeld ein Passwort mit bis zu fünf Zeichen ein.
11. Drücken Sie die Taste . Geben Sie über das Zahlenfeld noch einmal das Passwort ein.
12. Drücken Sie die Taste . Das Postfach ist erstellt.
13. Durch Drücken der Taste  kehren Sie jeweils um eine Menüebene zurück.

9.9.2 Postfach/Benutzer-Daten anzeigen

Hinweis: Für die Konfiguration des Postfachbetriebes beim Netzbetreiber benötigen Sie die Postfach-ID (Durchwahlziffer). Das allgemeine Postfach hat die Postfach-ID "0". Bei der Anmeldung weiterer Benutzer wird automatisch die niedrigste freie Postfach-ID (1-4) vergeben.

1. Drücken Sie die Taste .
2. Wählen Sie mit der Taste  oder  im Display den Menüpunkt "SMS".
3. Drücken Sie die Taste .
4. Wählen Sie mit der Taste  oder  im Display die Option "Einstellungen".
5. Drücken Sie die Taste .
6. Wählen Sie mit der Taste  oder  im Display die Option "Benutzer".
7. Drücken Sie die Taste .
8. Wählen Sie mit der Taste  oder  im Display den gewünschten Benutzer.
9. Drücken Sie die Taste . Geben Sie das entsprechende Passwort ein.
10. Drücken Sie die Taste .
11. Wählen Sie mit der Taste  oder  im Display die Option "Apparatnummer".
12. Drücken Sie die Taste . Es wird die Apparatnummer angezeigt.

Hinweis: Die unter Schritt 12 angezeigte Apparatnummer entspricht beim Netzbetreiber der Postfach-ID.

13. Durch Drücken der Taste  kehren Sie jeweils um eine Menüebene zurück.

9.9.3 SMS-Nachricht an persönliches Postfach senden



















Hinweis: SMS-Postfächer können Sie nur nutzen, wenn der Netzbetreiber dies unterstützt. Eine Konfigurationsanleitung zur Einrichtung des Postfachbetriebes erfragen Sie bitte bei Ihrem Netzbetreiber.

Damit eine SMS in Ihr persönliches Postfach gelangt, muss der Absender Ihre Postfach-ID kennen und an Ihre Nummer anhängen.



















Sie können an Ihren SMS-Partner eine SMS über Ihr persönliches Postfach schicken.

Durch diese SMS erhält Ihr SMS-Partner Ihre SMS-Rufnummer mit der aktuellen Postfach-ID und kann diese im Telefonbuch speichern. Ist die Postfach-ID ungültig, wird die SMS nicht zugestellt.

9.9.4 Postfach/Benutzer-Daten ändern

1. Drücken Sie die Taste .
2. Wählen Sie mit der Taste  oder  im Display den Menüpunkt "SMS".
3. Drücken Sie die Taste .
4. Wählen Sie mit der Taste  oder  im Display die Option "Einstellungen".
5. Drücken Sie die Taste .
6. Wählen Sie mit der Taste  oder  im Display die Option "Benutzer".
7. Drücken Sie die Taste .
8. Wählen Sie mit der Taste  oder  im Display den gewünschten Benutzer.
9. Drücken Sie die Taste . Geben Sie das entsprechende Passwort ein.
10. Drücken Sie die Taste .
11. Wählen Sie mit der Taste  oder  eine der Optionen, die Sie ändern möchten, aus.
12. Drücken Sie die Taste . Ändern Sie die Einstellung.
13. Drücken Sie die Taste . Sie können jetzt weitere Änderungen vornehmen.
14. Durch Drücken der Taste  kehren Sie jeweils um eine Menüebene zurück.

9.9.5 Postfach/Benutzer löschen

1. Drücken Sie die Taste .
2. Wählen Sie mit der Taste  oder  im Display den Menüpunkt "SMS".
3. Drücken Sie die Taste .
4. Wählen Sie mit der Taste  oder  im Display die Option "Einstellungen".
5. Drücken Sie die Taste .
6. Wählen Sie mit der Taste  oder  im Display die Option "Benutzer".
7. Drücken Sie die Taste .
8. Wählen Sie mit der Taste  oder  im Display die Option "Benutzer löschen".
9. Drücken Sie die Taste .
10. Wählen Sie mit der Taste  oder  den gewünschten Benutzer.
11. Drücken Sie die Taste . Geben Sie die System-PIN (Voreinstellung= 0000) ein.
12. Drücken Sie die Taste .
13. Durch Drücken der Taste  kehren Sie jeweils um eine Menüebene zurück.

10 Anruferlisten

10.1 Rufnummernanzeige (Clip)

Mit der Rufnummernanzeige können Sie bei eingehenden Gesprächen erkennen, wer Sie anruft. Wenn diese Funktion an Ihrer Telefonleitung zur Verfügung steht, zeigt Ihnen das Display bereits die Rufnummer des Anrufers, wenn das Telefon klingelt. Hat der Anrufer das Senden seiner Rufnummer gespart, kann die Rufnummer nicht angezeigt werden. Haben Sie diese Rufnummer in Ihrem Telefonbuch gespeichert, wird anstatt der Rufnummer der Name angezeigt.











Die Listen "Eingegangene Anrufe" und "Entgangene Anrufe" haben einen gemeinsamen Speicherplatz für 50 Rufnummern. Sind z. B. in der Liste der "Eingegangenen Anrufe" 32 Rufnummern gespeichert, stehen für die "Entgangenen Anrufe" noch 18 Speicherplätze zur Verfügung. Sobald alle 50 Speicherplätze belegt sind, wird immer der älteste Eintrag gelöscht.

Hinweis: Die Rufnummernanzeige ist ein optionaler Service Ihres Netzbetreibers. Ihr Telefon zeigt die Rufnummern im Display, wenn Ihr Netzbetreiber diesen Service anbietet. Die Anzeige des Datums und der Uhrzeit wird nicht von allen Netzbetreibern übertragen. Bitte fragen Sie Ihren Netzbetreiber nach weiteren Informationen. Auch bei manchen Nebenstellenanlagen ist eine Übertragung der Rufnummer oder auch des Datums und der Uhrzeit nicht möglich.













10.2 Eingegangene Anrufe



In der Liste "Eingegangene Anrufe" werden alle Anrufe, die Sie entgegengenommen haben gespeichert.



10.2.1 Anzeigen und zurückrufen

1. Drücken Sie die Taste .
2. Wählen Sie mit der Taste  oder  im Display den Menüpunkt "Anruferlisten".
3. Drücken Sie die Taste .
4. Wählen Sie mit der Taste  oder  im Display die Option "Eingegangene Anrufe".
5. Drücken Sie die Taste . Im Display werden die eingegangenen Anrufe angezeigt.
6. Möchten sie einen eingegangenen Anruf zurückrufen, wählen Sie mit der Taste  oder  im Display die gewünschte Nummer aus.
7. Drücken Sie die Taste . Die Verbindung wird hergestellt.

10.2.2 Eintrag löschen













1. Drücken Sie die Taste .
2. Wählen Sie mit der Taste  oder  im Display den Menüpunkt "Anruferlisten".
3. Drücken Sie die Taste .
4. Wählen Sie mit der Taste  oder  im Display die Option "Eingegangene Anrufe".
5. Drücken Sie die Taste . Im Display werden die eingegangenen Anrufe angezeigt.
6. Wählen Sie mit der Taste  oder  im Display die gewünschte Nummer aus.
7. Drücken Sie die Taste .
8. Wählen Sie mit der Taste  oder  im Display die Option "Löschen".

Hinweis: Neben der Option "Löschen" steht Ihnen auch die Option "Details anzeigen" zur Verfügung. Wählen Sie "Details anzeigen" aus, zeigt das Display durch Drücken der Taste  Name und Rufnummer an. Durch Drücken der Taste  kehren Sie zur Anruferliste "Eingegangene Anrufe" zurück.

9. Drücken Sie die Taste . Das Löschen wird im Display bestätigt.
10. Das Mobilteil kehrt zurück in die Anruferliste "Eingegangene Anrufe".
11. Möchten Sie weitere Einträge löschen, wiederholen Sie Punkt 6 bis 9.
12. Durch Drücken der Taste  kehren Sie jeweils um eine Menüebene zurück.



10.2.3 Eintrag im Telefonbuch speichern

Eine in der Anruferliste "Eingegangene Anrufe" gespeicherte Rufnummer kann direkt im Telefonbuch gespeichert werden.







1. Drücken Sie die Taste .
2. Wählen Sie mit der Taste  oder  im Display den Menüpunkt "Anruferlisten".
3. Drücken Sie die Taste .
4. Wählen Sie mit der Taste  oder  im Display die Option "Eingegangene Anrufe".
5. Drücken Sie die Taste . Im Display werden die eingegangenen Anrufe angezeigt.
6. Wählen Sie mit der Taste  oder  im Display die gewünschte Nummer aus.
7. Drücken Sie die Taste .
8. Wählen Sie mit der Taste  oder  im Display die Option "Nr. einfügen".
9. Drücken Sie die Taste .
10. Geben Sie nun den zugehörigen Namen über das Zahlenfeld ein.
11. Drücken Sie zweimal die Taste . Im Display wird der Eintrag bestätigt.
12. Durch Drücken der Taste kehren Sie jeweils um eine Menüebene zurück.

10.3 Entgangene Anrufe



In der Liste "Entgangene Anrufe" werden alle nicht entgegengenommene Anrufe gespeichert, sodass Sie auch während Ihrer Abwesenheit keinen Anruf verpassen. Sie haben drei Möglichkeiten, in die Anruferliste "Entgangene Anrufe" zu gelangen:

- Drücken Sie die Taste , oder
- wird im Display angezeigt, dass entgangene Anrufe gespeichert wurden, drücken Sie die Taste , oder
- wie unter 10.3.1 beschrieben.







10.3.1 Anzeigen und zurückrufen



1. Drücken Sie die Taste .
2. Wählen Sie mit der Taste  oder  im Display den Menüpunkt "Anruferlisten".
3. Drücken Sie die Taste .
4. Wählen Sie mit der Taste  oder  im Display die Option "Entgangene Anrufe".
5. Drücken Sie die Taste . Im Display werden die entgangenen Anrufe angezeigt.



Hinweis: Die neuen Eingänge sind mit einem Stern markiert.

6. Möchten Sie einen entgangenen Anruf zurückrufen, wählen Sie mit der Taste  oder  im Display die gewünschte Nummer aus.
7. Drücken Sie die Taste . Die Verbindung wird hergestellt.

10.3.2 Eintrag löschen









1. Drücken Sie die Taste . Im Display werden die entgangenen Anrufe angezeigt.
2. Wählen Sie mit der Taste  oder  im Display die gewünschte Nummer aus.
3. Drücken Sie die Taste .
4. Wählen Sie mit der Taste  oder  im Display die Option "Löschen".

Hinweis: Neben der Option "Löschen" steht Ihnen auch die Option "Details anzeigen" zur Verfügung. Wählen Sie "Details anzeigen" aus, zeigt das Display durch Drücken der Taste  Name und Rufnummer an. Durch Drücken der Taste  kehren Sie zur Anruferliste "Entgangene Anrufe" zurück.

5. Drücken Sie die Taste . Das Löschen wird im Display bestätigt.
6. Durch Drücken der Taste  kehrt das Mobilteil zurück in den Ruhezustand.

10.3.3 Eintrag im Telefonbuch speichern

Eine in der Anruferliste "Entgangene Anrufe" gespeicherte Rufnummer kann direkt im Telefonbuch gespeichert werden.

1. Drücken Sie die Taste . Im Display werden die entgangenen Anrufe angezeigt.
2. Wählen Sie mit der Taste  oder  im Display die gewünschte Nummer aus.
3. Drücken Sie die Taste .
4. Wählen Sie mit der Taste  oder  im Display die Option "Nr. einfügen".
5. Drücken Sie die Taste . Geben Sie über das Tastenfeld den Namen ein.
6. Drücken Sie zweimal die Taste . Im Display wird der Eintrag bestätigt.
7. Durch Drücken der Taste  kehrt das Mobilteil zurück in den Ruhezustand.

Hinweis: Sobald die Rufnummer im Telefonbuch mit einem Namen gespeichert wurde, erscheint in der Anruferliste nicht mehr die Rufnummer, sondern der eingegebene Name.



10.4 Gewählte Nummern (Wahlwiederholung)

In der Liste "Gewählte Nummern" werden alle von Ihnen gewählten Nummern gespeichert.







10.4.1 Anzeigen und anrufen



1. Drücken Sie die Taste . Im Display werden die gewählten Nummern angezeigt.



Hinweis: Ist eine Nummer im Telefonbuch gespeichert, wird zusätzlich der Name angezeigt.

2. Möchten Sie eine gewählte Nummer anrufen, wählen Sie mit der Taste  oder  im Display die gewünschte Nummer aus.
3. Drücken Sie die Taste . Die Verbindung wird hergestellt.

10.4.2 Eintrag löschen

1. Drücken Sie die Taste . Im Display werden die gewählten Nummern angezeigt.
2. Wählen Sie mit der Taste  oder  im Display die gewünschte Nummer aus.
3. Drücken Sie die Taste .
4. Wählen Sie mit der Taste  oder  im Display die Option "Löschen".









Hinweis: Neben der Option "Löschen" steht Ihnen auch die Option "Details anzeigen" zur Verfügung. Wählen Sie "Details anzeigen" aus, zeigt das Display durch Drücken der Taste  Name und Rufnummer an. Durch Drücken der Taste  kehren Sie zur Anruferliste "Entgangene Anrufe" zurück.

5. Drücken Sie die Taste . Das Löschen wird im Display bestätigt.
6. Durch Drücken der Taste  kehren Sie jeweils um eine Menüebene zurück.

- Anruferlisten -

10.4.3 Eintrag im Telefonbuch speichern

Eine in der Anruferliste "Gewählte Nummern" gespeicherte Rufnummer kann direkt im Telefonbuch gespeichert werden.











1. Drücken Sie die Taste . Im Display werden die gewählten Nummern angezeigt.
2. Wählen Sie mit der Taste  oder  im Display die gewünschte Nummer aus.
3. Drücken Sie die Taste .
4. Wählen Sie mit der Taste  oder  im Display die Option "Nr. einfügen".
5. Drücken Sie die Taste . Geben Sie über das Tastenfeld den Namen ein.
6. Drücken Sie zweimal die Taste . Im Display wird der Eintrag bestätigt.
7. Durch Drücken der Taste  kehren Sie jeweils um eine Menüebene zurück.

Hinweis: Sobald die Rufnummer im Telefonbuch mit einem Namen gespeichert wurde, erscheint in der Anruferliste nicht mehr die Rufnummer, sondern der eingegebene Name.



10.4.4 Eine Anruferliste löschen

Sie haben die Möglichkeit, alle Einträge einer Anruferliste ("Eingegangene Anrufe", "Entgangene Anrufe" oder "Gewählte Nummern") Ihrer Wahl zu löschen.

Hinweis: Der Ablauf ist am Beispiel der Anruferliste "Eingegangene Anrufe" beschrieben. Der Ablauf gilt genauso für die Anruferlisten "Entgangene Anrufe" und "Gewählte Nummern".











1. Drücken Sie die Taste .
2. Wählen Sie mit der Taste  oder  im Display den Menüpunkt "Anruferlisten".
3. Drücken Sie die Taste .
4. Wählen Sie mit der Taste  oder  im Display die Option "Anruferliste löschen".
5. Drücken Sie die Taste .
6. Wählen Sie mit der Taste  oder  im Display die Option "Eingegangene Anrufe".
7. Drücken Sie die Taste .
8. Drücken Sie die Taste . Im Display erscheint die Abfrage zum Löschen der Anruferliste.

Hinweis: Im nächsten Schritt werden alle Einträge in der Anruferliste "Eingegangene Anrufe" unwiederbringlich gelöscht. Durch das Drücken der Taste  wird der Löschvorgang abgebrochen.



9. Drücken Sie die Taste . Das Löschen wird im Display bestätigt.
10. Durch Drücken der Taste  kehren Sie jeweils um eine Menüebene zurück.

10.4.5 Alle Anruferlisten löschen

Sie haben die Möglichkeit, alle Einträge in den Anruferlisten ("Eingegangene Anrufe", "Entgangene Anrufe" und "Gewählte Nummern") komplett zu löschen.

1. Drücken Sie die Taste .
2. Wählen Sie mit der Taste  oder  im Display den Menüpunkt "Anruferlisten".
3. Drücken Sie die Taste .
4. Wählen Sie mit der Taste  oder  im Display die Option "Anruferliste löschen".
5. Drücken Sie die Taste .
6. Wählen Sie mit der Taste  oder  im Display die Option "Alle Anrufe".
7. Drücken Sie die Taste . Im Display erscheint die Abfrage zum Löschen aller Einträge.

Hinweis: Im nächsten Schritt werden alle Einträge in den Anruferlisten ("Eingegangene Anrufe", "Entgangene Anrufe" und "Gewählte Nummern") unwiederbringlich gelöscht. Durch das Drücken der Taste  wird der Löschvorgang abgebrochen.















8. Drücken Sie die Taste . Das Löschen wird im Display bestätigt.
9. Durch Drücken der Taste  kehren Sie jeweils um eine Menüebene zurück.

11 Mobilteil









An Ihrem Mobilteil können Sie nach Ihren Wünschen, verschiedene Einstellungen vornehmen.

11.1 Ruftonmelodie zuweisen (interne und externe Anrufe)



Sie können internen und externen Anrufen unterschiedliche Ruftonmelodien zuweisen. Die Einstellung ist am Beispiel für externe Anrufe beschrieben.

1. Drücken Sie die Taste .
2. Wählen Sie mit der Taste  oder  im Display den Menüpunkt "Mobilteil".
3. Drücken Sie die Taste . Im Display werden mehrere Optionen angezeigt.
4. Wählen Sie mit der Taste  oder  die Option "Rufton".
5. Drücken Sie die Taste .
6. Wählen Sie mit der Taste  oder  die Option "Externe Anrufe".
7. Drücken Sie die Taste . Im Display erscheinen mehrere Melodien zur Auswahl.
8. Wählen Sie mit der Taste  oder  die gewünschte Melodie.
9. Drücken Sie die Taste . Die Zuweisung wird im Display bestätigt.
10. Durch Drücken der Taste  kehren Sie jeweils um eine Menüebene zurück.













11.2 Ruftonlautstärke einstellen

1. Drücken Sie die Taste .
2. Wählen Sie mit der Taste  oder  im Display den Menüpunkt "Mobilteil".
3. Drücken Sie die Taste . Im Display werden mehrere Optionen angezeigt.
4. Wählen Sie mit der Taste  oder  die Option "Ruftonlautstärke".
5. Drücken Sie die Taste .
6. Wählen Sie mit der Taste  oder  die gewünschte Ruftonlautstärke.

Hinweis: Wählen Sie die Option "Lautst. aus" erscheint das Symbol  im Display.











7. Drücken Sie die Taste . Die Zuweisung wird im Display bestätigt.
8. Durch Drücken der Taste  kehren Sie jeweils um eine Menüebene zurück.

11.3 Namen des Mobilteils eingeben/ändern

1. Drücken Sie die Taste .
2. Wählen Sie mit der Taste  oder  im Display den Menüpunkt "Mobilteil".
3. Drücken Sie die Taste . Im Display werden mehrere Optionen angezeigt.
4. Wählen Sie mit der Taste  oder  die Option "Name Mobilteil".
5. Drücken Sie die Taste . Das Display zeigt die Meldung "Name".
6. Geben Sie den gewünschten Namen ein (maximal 8 Zeichen). Falsche Eingaben können Sie mit der Taste  löschen. Um den Cursor nach links oder rechts zu bewegen, drücken Sie die Taste  oder .
7. Drücken Sie die Taste . Die Zuweisung wird im Display bestätigt.
8. Durch Drücken der Taste  kehren Sie jeweils um eine Menüebene zurück.











11.4 Sprache einstellen

Sie können sich die Display-Texte in verschiedenen Sprachen anzeigen lassen.

1. Drücken Sie die Taste .
2. Wählen Sie mit der Taste  oder  im Display den Menüpunkt "Mobilteil".
3. Drücken Sie die Taste . Im Display werden mehrere Optionen angezeigt.
4. Wählen Sie mit der Taste  oder  die Option "Sprache".
5. Drücken Sie die Taste . Im Display erscheinen mehrere Sprachen zur Auswahl.
6. Wählen Sie mit der Taste  oder  die gewünschte Sprache.
7. Drücken Sie die Taste . Die Zuweisung wird im Display bestätigt.
8. Durch Drücken der Taste  kehren Sie jeweils um eine Menüebene zurück.











11.5 Menüfarbe einstellen

Sie können die Hintergrundfarben innerhalb der Menüpunkte einstellen.

1. Drücken Sie die Taste .
2. Wählen Sie mit der Taste  oder  den Menüpunkt "Mobilteil".
3. Drücken Sie die Taste . Im Display werden mehrere Optionen angezeigt.
4. Wählen Sie mit der Taste  oder  die Option "Menüfarbe".
5. Drücken Sie die Taste . Im Display erscheinen mehrere Farben zur Auswahl.
6. Wählen Sie mit der Taste  oder  die gewünschte Farbe.
7. Drücken Sie die Taste . Die Zuweisung wird im Display bestätigt.
8. Durch Drücken der Taste  kehren Sie jeweils um eine Menüebene zurück.















11.6 Automatische Gesprächsannahme aktivieren

Wenn Sie diese Funktion eingestellt haben, können Sie einen Anruf einfach durch Entnahme des Mobilteils aus der Basisstation entgegennehmen. Sie müssen dann nicht extra die Gesprächstaste  drücken.

1. Drücken Sie die Taste .
2. Wählen Sie mit der Taste  oder  den Menüpunkt "Mobilteil".
3. Drücken Sie die Taste . Im Display werden mehrere Optionen angezeigt.
4. Wählen Sie mit der Taste  oder  die Option "Automatische Gesprächsannahme".
5. Drücken Sie die Taste .
6. Wählen Sie mit der Taste  oder  die Option "Ein".
7. Drücken Sie die Taste . Die Zuweisung wird im Display bestätigt.
8. Durch Drücken der Taste  kehren Sie jeweils um eine Menüebene zurück.







11.7 Zugangskode (Amtskennziffer) aktivieren

Bei einigen Nebenstellenanlagen müssen Sie erst eine bestimmte Ziffer wählen (z. B. "0" oder "9"), bevor Sie ein Freizeichen für eine Amtsleitung erhalten. Tragen Sie hier eine Ziffer ein, wird diese Ziffer automatisch den Telefonnummern vorgewählt, die Sie aus dem Telefonbuch oder einer Anruferliste ausgewählt haben.



1. Drücken Sie die Taste .
2. Wählen Sie mit der Taste  oder  den Menüpunkt "Mobilteil".
3. Drücken Sie die Taste . Im Display werden mehrere Optionen angezeigt.
4. Wählen Sie mit der Taste  oder  die Option "Zugangskode".
5. Drücken Sie die Taste .
6. Wählen Sie mit der Taste  oder  die Option "Kode einstellen".
7. Drücken Sie die Taste . Das Display zeigt die Meldung "Kode einstellen".
8. Geben Sie die benötigte Ziffer ein (maximal 4 Ziffern).
9. Drücken Sie die Taste . Die Zuweisung wird im Display bestätigt.
10. Wählen Sie nun die Option "Ein".
11. Drücken Sie die Taste . Die Zuweisung wird im Display bestätigt.
12. Wollen Sie die automatische Vorwahl wieder deaktivieren, wählen Sie die Option "Aus" und drücken Sie die Taste .
13. Durch Drücken der Taste  kehren Sie jeweils um eine Menüebene zurück.

12 Mobilteile an- und abmelden

12.1 Mobilteil anmelden

1. Drücken Sie die Taste .
2. Wählen Sie mit der Taste  oder  im Display den Menüpunkt "Anmeldung".
3. Drücken Sie die Taste .
4. Wählen Sie mit der Taste  oder  im Display die Option "Mobilteil anmelden".
5. Drücken Sie die Taste .
6. Wählen Sie mit der Taste  oder  im Display "Basis 1" aus.

Hinweis: Möchten Sie Ihr Mobilteil an einer neuen Basis anmelden, wählen Sie eine Basis, die nicht mit einem Stern markiert ist. Ist die Basis mit einem Stern markiert, ist der Speicherplatz belegt.

7. Drücken Sie die Taste  und geben Sie den PIN ein.
8. Drücken Sie die Taste . Im Display erscheint der Hinweis "Sucht Basis".
9. Drücken Sie an der Basis die Paging-Taste  so lange (ca. 5 Sek.), bis ein Signalton ertönt. Die Anmeldung wird eingeleitet.

Hinweis: Um das DECT-GAP Mobilteil eines anderen Herstellers anzumelden, folgen Sie den Hinweisen in der Bedienungsanleitung des Fremdherstellers und drücken dann die Taste  an der Basisstation.









10. Drücken Sie die Taste . Das Mobilteil ist jetzt angemeldet.

Das Mobilteil erhält automatisch die niedrigste freie interne Nummer (1-5).

Das erste angemeldete Mobilteil hat die interne Nummer 1. Das zweite hat die interne Nummer 2. Im Ruhezustand wird die interne Nummer nach dem Namen des Telefons im Display angezeigt.











12.2 Mobilteil abmelden

Hinweis: Ein Mobilteil kann nur über ein anderes, noch angemeldetes Mobilteil abgemeldet werden. Es ist also nicht möglich, diese Abmeldung mit dem Mobilteil durchzuführen, das abgemeldet werden soll.

1. Drücken Sie die Taste .
2. Wählen Sie mit der Taste  oder  im Display den Menüpunkt "Anmeldung".
3. Drücken Sie die Taste .
4. Wählen Sie mit der Taste  oder  im Display die Option "Mobilteil abmelden".
5. Drücken Sie die Taste . Geben Sie die PIN-Nummer ein.
6. Drücken Sie die Taste . Wählen Sie das abzumeldene Mobilteil aus.
7. Drücken Sie zweimal die Taste . Das Mobilteil ist jetzt abgemeldet.

12.3 Basis auswählen

Ist Ihr Mobilteil an mehreren Basen angemeldet, können Sie es auf eine feste Basis einstellen oder auf die automatische Suche nach der Basis mit dem besten Empfang. Um die automatische Suche zu deaktivieren, müssen sie ihr Mobilteil wieder auf eine feste Basis einstellen

1. Drücken Sie die Taste .
2. Wählen Sie mit der Taste  oder  im Display den Menüpunkt "Anmeldung".
3. Drücken Sie die Taste .
4. Wählen Sie mit der Taste  oder  im Display die Option "Basis auswählen".
5. Drücken Sie die Taste .
6. Wählen Sie mit der Taste  oder  im Display die gewünschte Basis, oder "Automatik".
7. Drücken Sie die Taste . Die Auswahl wird bestätigt.

13 Mehrere Mobilteile

Sie können fünf Mobilteile an Ihre Basisstation anmelden. Jedes Mobilteil kann immer nur an einer Basisstation angemeldet sein. Melden Sie Ihr Mobilteil an einer neuen Basis an, wird es automatisch an der alten abgemeldet.

Hinweis: Über den international genormten GAP Standard können SWITEL-Mobilteile und auch Mobilteile von Fremdherstellern in das Telefonsystem integriert werden. Genauso können Sie ein SWITEL Mobilteil an Basisstationen anderer Hersteller anmelden, sofern diese Geräte nach dem GAP Standard arbeiten.

Bei der Benutzung von zwei Mobilteilen erhalten Sie folgende Möglichkeiten:

- Interne Gespräche zwischen den Mobilteilen.
- Externe Gespräche können vom Mobilteil weitergeleitet werden.
- Eingehende externe Gespräche werden an allen Mobilteilen signalisiert.

Hinweis: Benutzt bereits das andere Mobilteil die externe Leitung, ist ein weiteres externes Gespräch nicht möglich.

GAP: **Generic Access Profile** = Standard für das Zusammenwirken von Mobilteilen und Basisstationen anderer Hersteller.

13.1 Intern telefonieren

Sobald Sie mehrere Mobilteile an einer Basisstation angemeldet haben, können Sie interne Gespräche führen.

1. Drücken Sie die Taste **(INT)** und die interne Nummer des Mobilteiles, z. B. **(INT) 2**.
2. Das Gespräch wird am gerufenen Mobilteil entgegengenommen.

Hinweis: Erreicht Sie während eines internen Gesprächs ein externer Anruf, hören Sie kurze Signaltöne und Sie sehen die Rufnummer des Anrufers im Display, falls diese verfügbar ist.

3. Beenden Sie das interne Gespräch mit der Taste **(END)**.
4. Drücken Sie die Taste **(EXT)**, um den externen Anruf anzunehmen.

13.2 Externe Gespräche an ein anderes Mobilteil weiterleiten

Haben Sie ein externes Gespräch an einem Mobilteil entgegengenommen, können Sie das externe Gespräch an ein anderes Mobilteil weiterleiten.

Drücken Sie dazu die Taste **(INT)** und dann die interne Nummer des gewünschten Mobilteils.

Hinweis: Sollte sich das gerufene Mobilteil nicht melden, können Sie das Gespräch durch Drücken der Taste **(INT)** wieder übernehmen.

Nachdem das interne Gespräch am anderen Mobilteil entgegengenommen wurde, haben Sie folgende Möglichkeiten:

1. **Rücksprache / Makeln:** Sie können nun mit dem internen Teilnehmer sprechen und durch das Drücken der Taste **(INT)** zum externen Gesprächspartner zurückkehren. Sie können so beliebig oft zwischen dem externen und internen Gespräch wechseln.
2. **Gespräch übergeben:** Durch das Drücken der Taste **(EXT)** am ersten Mobilteil, wird das externe Gespräch an das gerufene Mobilteil übergeben.

13.3 Konferenzgespräche führen

Ein externes Gespräch kann mit einem weiteren internen Teilnehmer zum Konferenzgespräch geschaltet werden. So können zwei Mobilteile gleichzeitig mit dem externen Teilnehmer sprechen.

1. Stellen Sie die gewünschte Verbindung zu dem externen Teilnehmer her.
2. Drücken Sie dann die Taste **(INT)** und die interne Nummer des gewünschten zweiten Mobilteils.
3. Hat der zweite, interne Teilnehmer das Gespräch entgegengenommen, drücken Sie die Taste **(#)** für 2 Sekunden und alle drei Teilnehmer sind zu einer Konferenz zusammengeschaltet.











Hinweis: Während einer Konferenz können Sie mit der Taste **(INT)** den externen Gesprächspartner auf Halten setzen. Durch erneutes Drücken der Taste **(#)** können Sie dann wieder zur Konferenz zurückschalten.

4. Die Konferenz wird durch das Auflegen eines der internen Gesprächspartner beendet.











14 Basis-Einstellungen

Unter diesem Menüpunkt sind Einstellungen beschrieben, die die Basisstation betreffen, wie z. B. Ruftonmelodie, Ruftonlautstärke und System-PIN.

14.1 Ruftonmelodie der Basisstation zuweisen











1. Drücken Sie die Taste .
2. Wählen Sie mit der Taste  oder  im Display den Menüpunkt "Basis-Einstellungen".
3. Drücken Sie die Taste . Im Display werden mehrere Optionen angezeigt.
4. Wählen Sie mit der Taste  oder  die Option "Rufton Basis".
5. Drücken Sie die Taste . Im Display erscheinen mehrere Melodien zur Auswahl.
6. Wählen Sie mit der Taste  oder  die gewünschte Melodie.
7. Drücken Sie die Taste . Die Zuweisung wird im Display bestätigt.
8. Durch mehrmaliges Drücken der Taste  kehrt das Mobilteil zurück in den Ruhezustand.

14.2 Ruftonlautstärke der Basisstation einstellen

1. Drücken Sie die Taste .
2. Wählen Sie mit der Taste  oder  im Display den Menüpunkt "Basis-Einstellungen".
3. Drücken Sie die Taste . Im Display werden mehrere Optionen angezeigt.
4. Wählen Sie mit der Taste  oder  die Option "Lautstärke Basis".
5. Drücken Sie die Taste .
6. Wählen Sie mit der Taste  oder  die gewünschte Ruftonlautstärke.
7. Drücken Sie die Taste . Die Zuweisung wird im Display bestätigt.
8. Durch mehrmaliges Drücken der Taste  kehrt das Mobilteil zurück in den Ruhezustand.

14.3 Vorrangiges Klingeln eines Mobilteils aktivieren/deaktivieren







Hier können Sie einstellen, ob bei einem eingehenden Anruf alle angemeldeten Mobilteile klingeln sollen oder ob vorrangig zunächst nur ein bestimmtes Mobilteil klingeln soll.

1. Drücken Sie die Taste .
2. Wählen Sie mit der Taste  oder  im Display den Menüpunkt "Basis-Einstellungen".
3. Drücken Sie die Taste . Im Display werden mehrere Optionen angezeigt.
4. Wählen Sie mit der Taste  oder  die Option "Vorrang Mobilteil".
5. Drücken Sie die Taste . Im Display werden mehrere Optionen angezeigt.
6. Wählen Sie die Option "Mobilteil auswählen".
7. Drücken Sie die Taste . Wählen Sie das gewünschte Mobilteil aus.
8. Drücken Sie die Taste . Im Display werden mehrere Optionen angezeigt. Wählen Sie z. B. die Option "Ruftöne 4", so klingelt zunächst das vorrangig ausgewählte Mobilteil viermal, bevor dann weitere Mobilteile klingeln.
9. Wählen Sie eine Option aus und drücken Sie die Taste . Die Zuweisung wird im Display bestätigt.
10. Durch Drücken der Taste  kehren Sie jeweils um eine Menüebene zurück.





Hinweis: Möchten Sie, dass alle Mobilteile gleichzeitig klingeln, wählen Sie unter Schritt 6 die Option "Alle Mobilteile", drücken Sie die Taste  und verlassen Sie die Einstellung.

14.4 Flashzeiten einstellen











Sie können zwei Flash-Zeiten einstellen, "Flash 1" (100 ms) oder "Flash 2" (300 ms). Für den Betrieb in Nebenstellenanlagen benötigen Sie eine Flashzeit von 100 ms. Die Zusatzdienste der Swisscom z. B. arbeiten mit einer Flashzeit von 300 ms.

1. Drücken Sie die Taste .
2. Wählen Sie mit der Taste  oder  im Display den Menüpunkt "Basis-Einstellungen".
3. Drücken Sie die Taste . Im Display werden mehrere Optionen angezeigt.
4. Wählen Sie mit der Taste  oder  die Option "Flashzeiten".

- Basis-Einstellungen -

5. Drücken Sie die Taste . Im Display erscheinen zwei Flashzeiten zur Auswahl.
6. Wählen Sie mit der Taste  oder  die Flashzeit "Flash 1" (100 ms) oder "Flash 2" (300 ms).
7. Drücken Sie die Taste . Die Zuweisung wird im Display bestätigt.
8. Durch Drücken der Taste  kehren Sie jeweils um eine Menüebene zurück.

14.5 System-PIN ändern





1. Drücken Sie die Taste .
2. Wählen Sie mit der Taste  oder  im Display den Menüpunkt "Basis-Einstellungen".
3. Drücken Sie die Taste . Im Display werden mehrere Optionen angezeigt.
4. Wählen Sie mit der Taste  oder  die Option "System-PIN".
5. Drücken Sie die Taste . Im Display erscheint die Meldung "Alte PIN eingeben".
6. Geben Sie die alte PIN-Nummer ein (Werkseinstellung: 0000). Anstelle einer eingegebenen Zahl erscheint im Display ein "*". Haben Sie eine Zahl falsch eingegeben, können Sie sie mit der Taste  löschen.
7. Haben Sie die alte PIN-Nummer vollständig eingegeben, drücken Sie die Taste . Es erscheint die Meldung "Neue PIN eingeben".
8. Geben Sie eine neue PIN-Nummer ein (maximal 8 Ziffern).
9. Drücken Sie die Taste . Es erscheint die Meldung "Neue PIN bestätigen".
10. Geben Sie nochmals die neue PIN-Nummer ein.
11. Drücken Sie die Taste . Die Zuweisung wird im Display bestätigt.

Hinweis: Sollten Sie die PIN-Nummer einmal vergessen haben, müssen Sie das Telefon auf die Werkseinstellungen zurücksetzen (siehe 14.6).

12. Durch Drücken der Taste  kehren Sie jeweils um eine Menüebene zurück.

14.6 Werkseinstellungen wiederherstellen











Hinweis: Durch die Wiederherstellung der Werkseinstellungen gehen alle Einträge verloren.

1. Drücken Sie für 2 Sek. die Taste . Das Mobilteil ist ausgeschaltet.
2. Drücken Sie für 2 Sek. die Taste . Das Mobilteil wird eingeschaltet.
3. Drücken Sie die Taste  bevor der Startbildschirm im Display erscheint.
4. Im Display erscheint die Meldung "Fabrik Einstellungen".
5. Drücken Sie die Taste . Es ertönt ein Bestätigungston an der Basisstation und dem Mobilteil. Das Telefon ist jetzt wieder im Auslieferungszustand.

15 Zeiteinstellung

Sie verpassen keinen Termin durch die 24-Stunden-Uhr mit integrierter Weck-/Alarmfunktion.

15.1 Zeit und Datum einstellen















1. Drücken Sie die Taste .
2. Wählen Sie mit der Taste  oder  im Display den Menüpunkt "Zeiteinstellung".
3. Drücken Sie die Taste .
4. Wählen Sie mit der Taste  oder  im Display die Option "Zeit und Datum ein...".
5. Drücken Sie die Taste . Geben Sie über das Zahlenfeld das Datum ein.
6. Drücken Sie die Taste . Geben Sie über das Zahlenfeld die Zeit ein.
7. Drücken Sie die Taste . Die Angaben werden gespeichert.
8. Durch Drücken der Taste  kehren Sie jeweils um eine Menüebene zurück.

Hinweis: Durch Stromausfall oder durch Trennung des Netztesles von der Steckdose gehen Datum und Uhrzeit verloren.

15.2 Weckton einstellen

1. Drücken Sie die Taste .
2. Wählen Sie mit der Taste  oder  im Display den Menüpunkt "Zeiteinstellung".
3. Drücken Sie die Taste .
4. Wählen Sie mit der Taste  oder  im Display die Option "Wecker".
5. Drücken Sie die Taste .
6. Wählen Sie mit der Taste  oder  im Display die Option "Weckton einstellen".
7. Drücken Sie die Taste .
8. Wählen Sie mit der Taste  oder  im Display den gewünschten Weckton.
9. Drücken Sie die Taste . Der Weckton wird gespeichert.

15.3 Weckzeit eingeben (EIN/AUS)

1. Drücken Sie die Taste .
2. Wählen Sie mit der Taste  oder  im Display den Menüpunkt "Zeiteinstellung".
3. Drücken Sie die Taste .
4. Wählen Sie mit der Taste  oder  im Display die Option "Wecker".
5. Drücken Sie die Taste .
6. Wählen Sie mit der Taste  oder  im Display die Option "Ein/Aus".
7. Drücken Sie die Taste .
8. Wählen Sie mit der Taste  oder  im Display, ob Sie "Einmalig", oder "Täglich" zur gleichen Zeit alarmiert werden möchten.
9. Drücken Sie die Taste . Geben Sie die gewünschte Zeit ein.
10. Drücken Sie die Taste . Die Angaben werden gespeichert.

Hinweis: Durch Eingeben der Weckzeit wird die Weckfunktion eingeschaltet. Im Display erscheint neben der Zeitanzeige das Symbol .
Um die Weckfunktion wieder auszuschalten, wählen Sie bei Schritt 8 die Option "Aus".

11. Durch Drücken der Taste  kehren Sie jeweils um eine Menüebene zurück.

- Fehlerbeseitigung -

16 Fehlerbeseitigung

Haben Sie Probleme mit Ihrem Telefon, kontrollieren Sie bitte zuerst die folgenden Hinweise. Bei Garantieansprüchen wenden Sie sich bitte an Ihren Fachhändler. Die Garantiezeit beträgt 2 Jahre.

Fehler	Lösungen
Das Display zeigt nichts an	<ul style="list-style-type: none"> - Mobilteil ist nicht eingeschaltet. - Die Akkus sind leer oder defekt.
Die Nummer des Anrufers wird trotz CLIP nicht angezeigt.	<ul style="list-style-type: none"> - Anrufer hat die Nummernübermittlung beim Netzanbieter nicht freischalten lassen.
Keine Verbindung zur Basisstation möglich	<ul style="list-style-type: none"> - Prüfen Sie, ob Sie sich mit der richtigen PIN Nummer an der Basisstation angemeldet haben.
Kein Telefongespräch möglich	<ul style="list-style-type: none"> - Die Telefonleitung ist nicht korrekt angeschlossen oder gestört. Verwenden Sie nur das mitgelieferte Telefonkabel. - Testen Sie mit einem anderen Telefon, ob Ihr Telefonanschluss in Ordnung ist. - Das Netzteil ist nicht eingesteckt oder es liegt ein totaler Stromausfall vor. - Die Akkus sind leer oder defekt. - Sie haben sich zu weit von der Basisstation entfernt.
Verbindung abgehackt, fällt aus	<ul style="list-style-type: none"> - Sie haben sich zu weit von der Basisstation entfernt. - Falscher Aufstellungsort der Basisstation.
Die Ladekontrollleuchte leuchtet nicht	<ul style="list-style-type: none"> - Stellen Sie das Mobilteil richtig auf die Basisstation, reinigen Sie die Kontaktflächen am Mobilteil und an der Basisstation mit einem weichen, trockenen Tuch.
Im Display blinkt nach ein paar Stunden das Batterie-Symbol	<ul style="list-style-type: none"> - Legen Sie das Mobilteil für 14 Stunden auf die Basisstation. Hilft dies nicht, erneuern Sie die aufladbaren Standard-Akkus.
Display-Anzeige dunkel	<ul style="list-style-type: none"> - Verursacht durch direkte Sonnenbestrahlung, Mobilteil abkühlen lassen.
Es kann keine SMS verschickt werden	<ul style="list-style-type: none"> - Kontrollieren Sie die richtige Eingabe des SMS-Centers. Fragen Sie Ihren Telefonnetzbetreiber. - Ihr Telefon ist an eine Nebenstelle angeschlossen. - Aktivieren Sie den SMS-Dienst bei Ihrem Telefonnetzbetreiber.

17 Wichtige Informationen

17.1 Technische Daten

Merkmal	Wert
Standard	DECT-GAP
Stromversorgung	Basisstation 220/230 V, 50 Hz
Reichweite (Außen/Innen)	300 m / 50 m
Standby	bis zu 85 h
Max. Gesprächsdauer	bis zu 10 h
Aufladbare Standard-Akkus	2 x AAA (1.2V / 750 mAh)
Wahlverfahren	Ton-Wahlverfahren (MFV)
Zulässige Umgebungstemperatur	10°C bis 30°C
Zulässige relative Luftfeuchtigkeit	20% bis 75%
Flash-Zeiten	100 ms oder 300 ms

DECT: **D**igital **E**uropean **C**ordless **T**elephone = Standard für kabellose Telefone.

GAP: **G**eneric **A**ccess **P**rofile = Standard für das Zusammenwirken von Mobilteilen und Basisstationen anderer Hersteller.

17.2 Garantie

Switel - Geräte werden nach den modernsten Produktionsverfahren hergestellt und geprüft. Ausgesuchte Materialien und hoch entwickelte Technologien sorgen für einwandfreie Funktion und lange Lebensdauer. Ein Garantiefall liegt nicht vor, wenn die Ursache einer Fehlfunktion des Gerätes bei dem Telefonnetzbetreiber oder einer eventuell zwischengeschalteten Nebenstellenanlage liegt. Die Garantie gilt nicht für die in den Produkten verwendeten Standard-Akkus oder Akkupacks. Die Garantiezeit beträgt 24 Monate, gerechnet vom Tage des Kaufs.

Innerhalb der Garantiezeit werden alle Mängel, die auf Material- oder Herstellungsfehler zurückzuführen sind, kostenlos beseitigt. Der Garantieanspruch erlischt bei Eingriffen durch den Käufer oder durch Dritte. Schäden, die durch unsachgemäße Behandlung oder Bedienung, durch falsches Aufstellen oder Aufbewahren, durch unsachgemäßen Anschluss oder Installation sowie durch höhere Gewalt oder sonstige äußere Einflüsse entstehen, fallen nicht unter die Garantieleistung. Wir behalten uns vor, bei Reklamationen die defekten Teile auszubessern oder zu ersetzen oder das Gerät auszutauschen. Ausgetauschte Teile oder ausgetauschte Geräte gehen in unser Eigentum über. Schadenersatzansprüche sind ausgeschlossen, soweit sie nicht auf Vorsatz oder grober Fahrlässigkeit des Herstellers beruhen.

Sollte Ihr Gerät dennoch einen Defekt innerhalb der Garantiezeit aufweisen, wenden Sie sich bitte unter Vorlage Ihrer Kaufquittung ausschließlich an das Geschäft, in dem Sie Ihr SWITEL - Gerät gekauft haben. Alle Gewährleistungsansprüche nach diesen Bestimmungen sind ausschließlich gegenüber Ihrem Fachhändler geltend zu machen. Nach Ablauf von zwei Jahren nach Kauf und Übergabe unserer Produkte können Gewährleistungsrechte nicht mehr geltend gemacht werden.



1	Généralités	35
1.1	Utilisation conforme aux prescriptions	35
1.2	Panne de courant	35
1.3	Lieu d'installation	35
1.4	Bloc secteur	35
1.5	Piles rechargeables standard	35
1.6	Chargement du combiné	35
1.7	Installations à postes supplémentaires	35
1.8	Restitution des anciens appareils	35
1.9	Remarque relative aux appareils médicaux	35
1.10	Température et conditions d'environnement	36
1.11	Nettoyage et entretien	36
2	Caractéristiques	37
2.1	Téléphone	37
3	Eléments de manipulation	38
3.1	Combiné	38
3.2	Base / station de chargement	38
4	Mise en service	39
4.1	Remarques concernant la sécurité	39
4.2	Contrôle du contenu du paquet	39
4.3	Branchement de la base	39
4.4	Branchement de la station de chargement	39
4.5	Pose des piles rechargeables standard	39
4.6	Rechargement des piles rechargeables standard	39
4.7	Numérotation à fréquence vocale - MFG	39
5	Manipulation	40
5.1	L'écran	40
5.2	La navigation avec les touches	40
5.3	Passer et terminer un appel	40
5.4	Prendre un appel	40
5.5	Prendre deux appels externes	40
5.6	Mains-libres	40
5.7	Composition des numéros d'appel du répertoire	41
5.8	Affichage de la durée de la communication	41
5.9	Réglage du volume sonore de l'écouteur	41
5.10	Rappel	41
5.11	Désactiver le microphone du combiné	41
5.12	Branchement / débranchement du combiné	41
5.13	Chercher un combiné (paging)	41
5.14	Verrouillage du clavier	41
5.15	Remarque concernant la portée	41
6	Installations à postes / services supplémentaires	42
6.1	Touche R de mise en attente avec les installations à postes supplémentaires	42
6.2	Touche R de mise en attente et les services supplémentaires de la Swisscom	42
6.3	Pause de numérotation	42
7	Structure du menu	43
8	Le répertoire	45
8.1	Saisie d'un numéro d'appel dans le répertoire	45
8.2	Afficher les détails de l'enregistrement	45
8.3	Modification d'enregistrements sauvegardés dans le répertoire	45
8.4	Supprimer un enregistrement du répertoire	46
8.5	Suppression de tous les enregistrements du répertoire	46
8.6	Appel VIP (attribution d'une sonnerie d'appel)	46
9	Messages SMS	47
9.1	Centre de service	47
9.1.1	Saisie du numéro d'envoi et de réception	47
9.2	Ecrire et envoyer	47
9.3	Envoyer un message SMS enregistré	48

- Table des matières -

9.4	Lire et répondre	48
9.5	Activer/désactiver la sonnerie du message	48
9.6	Régler la sonnerie du message (sonnerie morse, discrète, polyphone)	49
9.7	Supprimer un message SMS	49
9.8	Supprimer tous les messages SMS	49
9.9	Boîte SMS	49
9.9.1	Insérer boîte/ utilisateur	49
9.9.2	Afficher les données d'une boîte/ d'un utilisateur	50
9.9.3	Envoyer un message SMS à la boîte personnelle	50
9.9.4	Modifier les données d'une boîte/ d'un utilisateur	50
9.9.5	Supprimer une boîte/ un utilisateur	50
10	Journaux des appels	51
10.1	Affichage du numéro d'appel (CLIP)	51
10.2	Appels répondus	51
10.2.1	Afficher et rappeler	51
10.2.2	Supprimer l'enregistrement	51
10.2.3	Enregistrer l'enregistrement dans le répertoire	51
10.3	Appels manqués	52
10.3.1	Afficher et rappeler	52
10.3.2	Supprimer l'enregistrement	52
10.3.3	Enregistrer l'enregistrement dans le répertoire	52
10.4	Numéros composés (rappel)	52
10.4.1	Afficher et appeler	52
10.4.2	Supprimer l'enregistrement	52
10.4.3	Enregistrer l'enregistrement dans le répertoire	52
10.4.4	Supprimer un journal des appels	53
10.4.5	Supprimer tous les journaux des appels	53
11	Combiné	54
11.1	Attribution d'une mélodie d'appel (appels internes et externes)	54
11.2	Régler le volume de la sonnerie d'appel	54
11.3	Saisir ou modifier les noms des combinés	54
11.4	Sélectionner la langue	54
11.5	Régler la couleur du menu	54
11.6	Activer la mise en communication automatique	54
11.7	Activer le code d'accès (indicatif réseau)	55
12	Déclarer et retirer des combinés	56
12.1	Déclarer un combiné	56
12.2	Retirer un combiné	56
12.3	Sélectionner base	56
13	Plusieurs combinés	57
13.1	Téléphoner à l'intérieur	57
13.2	Transfert de communications externes à un autre combiné	57
13.3	La conférence	57
14	Paramétrages de la base	58
14.1	Attribuer une mélodie d'appel à la base	58
14.2	Régler le volume de la sonnerie d'appel de la base	58
14.3	Activer/désactiver la sonnerie prioritaire d'un combiné	58
14.4	Régler les temps de flash	58
14.5	Modifier le PIN du système	58
15	Réglage de l'horloge	60
15.1	Réglage de la date et de l'heure	60
15.2	Régler sonnerie réveil	60
15.3	Saisir l'heure du réveil (activ / désac)	60
16	Elimination des perturbations	61
17	Informations importantes	62
17.1	Données techniques	62
17.2	Garantie	62

1 Généralités

Veuillez lire ce mode d'emploi attentivement et complètement.

N'ouvrez en aucun cas l'appareil et n'effectuez aucun essai de réparation vous-même. En ce qui concerne le droit à la garantie, adressez-vous à votre revendeur.

Dans le cadre des améliorations de produit, nous nous réservons le droit d'apporter à l'article des modifications techniques et d'optique.

1.1 Utilisation conforme aux prescriptions

Ce téléphone est conçu pour fonctionner avec un raccordement téléphonique analogique (PSTN) à l'intérieur de la Suisse. Toutefois, en raison des différences entre les divers exploitants de réseaux de télécommunication, on ne peut pas garantir un fonctionnement impeccable avec chaque raccordement de périphérique de télécommunication. Ne branchez le câble de raccordement du téléphone que dans les prises téléphoniques prévues à cet effet. Ne remplacez pas la fiche du câble de raccordement.

1.2 Panne de courant

En cas d'éventuelle panne de courant, on ne peut pas téléphoner avec le téléphone. Ayez en réserve, pour d'éventuels cas d'urgence, un téléphone à fil fonctionnant sans alimentation en courant externe.

1.3 Lieu d'installation

Le lieu d'installation exerce une influence décisive sur le fonctionnement impeccable du téléphone. Une prise réseau de 230 Volt doit se trouver sur le lieu d'installation.

Ne posez pas la base dans les environs immédiats d'autres appareils électroniques comme par ex. le micro-ondes ou des appareils HIFI car sinon ils peuvent exercer une influence réciproque. Respectez donc une distance d'au moins un mètre par rapport aux appareils électroniques. Posez la base sur une surface plane et antidérapante. Normalement, les pieds de la base ne laissent pas de traces sur la surface sur laquelle ils reposent. Toutefois, en raison de la diversité des laques et des surfaces utilisées, il n'est pas exclu que les pieds de l'appareil puissent laisser des traces sur la surface d'installation.

1.4 Bloc secteur

N'utilisez que le bloc d'alimentation enfichable de SWITEL fourni avec l'appareil car d'autres blocs d'alimentation peuvent détruire le téléphone. Il y a danger de mort quand le bloc d'alimentation enfichable est ouvert et n'est pas séparé du secteur.

1.5 Piles rechargeables standard

N'utilisez pas d'autres piles rechargeables standard ou des paquets de piles rechargeables car ils peuvent causer un court-circuit. Lors du remplacement des piles, n'utilisez toujours que des piles rechargeables standard du type AAA 1,2V 750mAh. Ne jetez jamais les piles rechargeables standard dans le feu et ne les plongez pas dans l'eau. N'éliminez pas les piles rechargeables standard usagées ou défectueuses dans les ordures ménagères normales. Les temps maximaux de veille et de communication indiqués se rapportent aux piles rechargeables standard fournies avec l'appareil quand elles fonctionnent dans des conditions optimales. La température ambiante, le cycle de rechargement et autres facteurs influants comme par ex. les perturbations radio dans tout l'environnement peuvent considérablement réduire les temps de fonctionnement. La capacité de charge se réduit, en outre, pour des raisons techniques au cours de son utilisation ou en raison de son stockage à très hautes ou très basses températures.



1.6 Chargement du combiné

S'il arrive que le combiné s'échauffe lors du chargement, cela est normal et n'est pas dangereux. Ne chargez pas le combiné avec des appareils de recharge autres car sinon des dommages peuvent se produire.

1.7 Installations à postes supplémentaires

On peut également raccorder le téléphone à une installation à postes supplémentaires. Votre revendeur, chez lequel vous avez acheté l'installation, vous dira si votre téléphone fonctionne impeccablement sur votre installation à postes supplémentaires. En raison du grand nombre d'installations à postes supplémentaires différentes, une garantie de fonctionnement ne peut pas être fournie.

1.8 Restitution des anciens appareils

Si vous souhaitez jeter votre appareil SWITEL, veuillez l'apporter à votre déchetterie communale (p. ex. centre de recyclage). Le symbole ci-contre sur votre téléphone signifie que votre appareil **ne doit pas être jeté dans les ordures ménagères normales**.



Selon la loi concernant les appareils électriques et électroniques, les anciens appareils électriques et électroniques doivent être jetés séparément. Vous aidez et contribuez à la protection de l'environnement si vous ne jetez pas l'ancien appareil dans les ordures ménagères normales.

1.9 Remarque relative aux appareils médicaux

Le téléphone travaille avec une puissance d'émission très faible. Cette puissance d'émission faible exclut un risque pour la santé selon le niveau actuel de la recherche et de la technique. Mais il s'avère que des téléphones portables branchés peuvent influencer les appareils médicaux. N'utilisez donc pas le téléphone dans les environs d'appareils médicaux.

Une influence sur les stimulateurs cardiaques due aux téléphones DECT n'a pas pu être observée jusqu'à ce jour. En raison du grand nombre de pacemakers implantés, cela ne peut toutefois pas être entièrement exclu. Les téléphones DECT peuvent causer un bourdonnement désagréable dans les prothèses auditives.

1.10 Température et conditions d'environnement

Le téléphone est conçu pour fonctionner dans des pièces abritées d'une température de 10°C à 30 °C. La base ne doit pas être placée dans des pièces humides comme la salle de bains ou la buanderie. Evitez le contact avec des sources de chaleur comme les radiateurs et n'exposez pas l'appareil à l'ensoleillement direct.

N'utilisez pas le combiné dans des régions susceptibles d'explosion.

Toute nuisance excessive provoquée par la fumée, la poussière, les vibrations, les produits chimiques, l'humidité, la grande chaleur ou l'ensoleillement direct doit être évitée.

1.11 Nettoyage et entretien

Les surfaces du boîtier peuvent être nettoyées avec un chiffon sec, doux et non pelucheux. Ne jamais utiliser de produits d'entretien ou de solvants corrosifs. Mis à part un nettoyage occasionnel du boîtier, aucun entretien n'est nécessaire. Les pieds en caoutchouc de la base ne résistent pas à tous les produits d'entretien. Le fabricant ne peut donc être tenu responsable pour d'éventuels dommages sur des meubles ou des modifications.

2 Caractéristiques

2.1 Téléphone

- DECT/GAP numérique standard
- Jusqu'à 10 heures de communication - jusqu'à 85 heures en mode veille
- Envoyer et recevoir un SMS
- Codage de la parole pour une grande sécurité
- Numérotation à fréquence vocale (MFV)
- Excellent affichage par écran lumineux
- Simplicité d'utilisation grâce à un menu graphique
- Affichage du numéro d'appel sur l'écran (CLIP)
- Journal des appels avec 50 mémoires pour les appels reçus ou manqués
- Rappel des derniers 20 numéros d'appel
- Répertoire avec 150 mémoires et noms
- Horloge 24 heures avec une fonction réveil/alarme intégrée au combiné
- Affichage de la durée de la communication
- Extensible grâce à d'autres combinés DECT compatibles GAP
- Fonctionnement en liaisons multiples, jusqu'à 4 combinés supplémentaires
- Communications internes possibles entre deux combinés
- Conférences téléphoniques entre deux combinés et un correspondant externe
- Transférer un appel entre deux combinés
- Mélodies multiples d'appel réglables pour le combiné et la base
- Appel VIP (attribution de mélodies)
- Conçu pour les services supplémentaires de Swisscom (Hook-Flash), utilisable sur des postes supplémentaires
- Silencieux
- Verrouillage de clavier
- Fonction mains-libres sur le combiné

DECT: **D**igital **E**uropean **C**ordless **T**elephone = Standard pour téléphones sans fil.

GAP : **G**eneric **A**ccess **P**rofile = Standard pour l'action conjointe de combinés et de bases de fabricants différents.

3 Éléments de manipulation

3.1 Combiné

1. Affichage graphique en couleur
2. Numéro composé / volume + / navigation dans le menu vers le haut
3. Répertoire (annuaire)
4. Terminer la communication / marche / arrêt
5. Appels manqués/ volume - / navigation dans le menu vers le bas
6. Verrouillage du clavier
7. Communications internes et conférences
8. Touche de signal R
9. Passer un appel / mains-libres
10. Touche de menu / touche de sélection

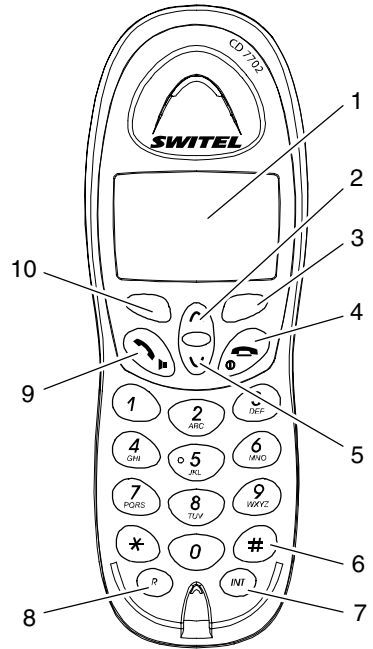

3.2 Base / station de chargement

11. Touche de paging (recherche du combiné)
12. Indicateur DEL de communication et d'alimentation
13. Voyant de charge DEL (base)
14. Voyant de charge DEL (station de chargement)

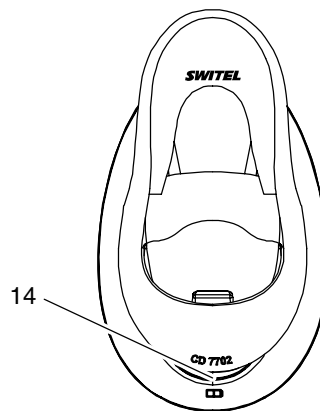
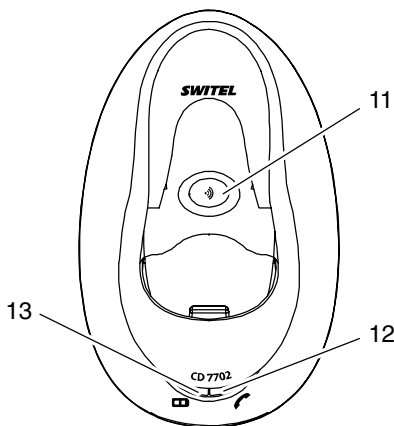

4 Mise en service

4.1 Remarques concernant la sécurité



Attention : Avant la mise en service, vous devez lire les généralités se trouvant au début de ce mode d'emploi.

4.2 Contrôle du contenu du paquet

Les éléments suivants font partie de la livraison :

une base et une station de chargement	un câble de raccordement téléphonique
deux combinés	quatre piles rechargeables standard
deux blocs d'alimentation	un mode d'emploi

4.3 Branchement de la base

Assurez-vous que la base se trouve dans les environs de votre prise de raccordement téléphonique et d'une prise réseau. N'utilisez que les composants livrés avec l'appareil.

1. Introduire la petite fiche du bloc d'alimentation dans la prise correspondante sur la face inférieure de la base.

Remarque: Vous ne pouvez pas vous tromper en branchant la fiche : la fiche et la prise sont protégées de par leur construction contre toute inversion de polarité. Les fiches doivent s'encliqueter de façon audible dans les prises de la base.

2. Mettre la petite fiche du câble de raccordement téléphonique dans la prise correspondante sur la face inférieure de la base.
3. Introduisez les deux câbles sur la face inférieure de la base dans le canal pour câble prévu à cet effet sur la face arrière.
4. Branchez le bloc d'alimentation dans une prise de réseau de 230 volts installée selon les spécifications. Le bloc d'alimentation de la base doit toujours rester branché.
5. Reliez le câble de raccordement téléphonique ci-joint avec la prise téléphonique.

4.4 Branchement de la station de chargement

Assurez-vous que la station de chargement pour le deuxième combiné se trouve dans les environs de votre prise de raccordement téléphonique. Branchez le bloc d'alimentation enfichable dans une prise de réseau de 230 volts installée selon les spécifications.

4.5 Pose des piles rechargeables standard

Pour placer dans le combiné les piles rechargeables standard fournies avec l'appareil, appuyez sur le cache du compartiment à piles sur le bord supérieur puis poussez le vers le bas. Placer ensuite les piles rechargeables standard. Tenez compte de la polarisation. Fermez le compartiment à piles.

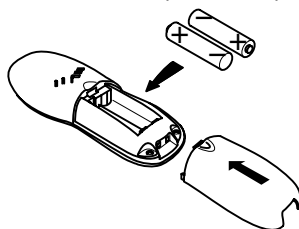

4.6 Rechargement des piles rechargeables standard

Placez le combiné dans la base ou la station de chargement avec l'écran dirigé vers l'avant pendant au moins 14 heures. Les voyants de contrôle de chargement s'allument à la base et à la station de chargement. Si les piles rechargeables standard ne sont pas correctement rechargées, il peut y avoir des erreurs de fonctionnement de la part du téléphone.

Les piles rechargeables standard de votre combiné possèdent un temps de veille de max. 85 heures à température ambiante. La durée maximale de communication est de 10 heures.

Le niveau actuel de chargement des piles est affiché sur l'écran :

Plein	Moyen	Faible	Vide

4.7 Numérotation à fréquence vocale - MFG

Ce téléphone utilise la numérotation à fréquence vocale MFG (signalisation multifréquence). Cette numérotation moderne permet de diminuer le temps de connexion, d'avoir la possibilité de commander à distance les appareils comme p. ex. le répondeur ainsi que d'utiliser d'autres fonctions ISDN.

5 Manipulation

5.1 L'écran





L'écran vous indique toutes les fonctions essentielles avec des symboles différents. Il est équipé d'un rétro-éclairage automatique qui éclaire l'écran pendant environ 30 secondes à chaque actionnement d'une touche.

5.2 La navigation avec les touches

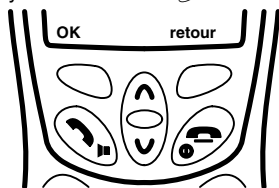
Vous avez accès à toutes les fonctions par l'intermédiaire d'un menu graphique très facile à utiliser. Si vous tenez toujours compte des textes du menu de l'écran, vous naviguerez sûrement et intuitivement.



Toutes les descriptions contenues dans ce mode d'emploi partent du principe que le combiné est en veille. En mode veille, une photo de plage et le nom du combiné apparaissent sur l'écran (préréglage "studio 1"). Vous obtiendrez le mode veille en appuyant sur la touche .



Touches	Description
	Selon la fonction de commande, la fonction actuelle est indiquée juste à gauche de l'écran par l'intermédiaire de la touche. La fonction est sélectionnée en appuyant sur la touche. En veille, la touche ouvre le menu.
	Selon la fonction de commande, la fonction actuelle est indiquée juste à droite de l'écran par l'intermédiaire de la touche. La fonction est sélectionnée en appuyant sur la touche. En veille, la touche ouvre le répertoire.
	En appuyant sur la touche, le menu est déroulé vers le haut.
	En appuyant sur la touche, le menu est déroulé vers le bas.
	En appuyant sur la touche, le processus est annulé et le combiné se remet en veille, quel que soit l'endroit du menu.

5.3 Passer et terminer un appel

1. Saisissez le numéro d'appel (max. 25 chiffres).

Remarque: En appuyant brièvement sur la touche , vous supprimez le chiffre saisi en dernier. En appuyant longuement sur la touche , le numéro d'appel est totalement supprimé. L'appareil se met en veille.

2. Appuyez sur la touche  et la liaison désirée s'établit.

Remarque: Vous pouvez appuyer d'abord sur la touche , puis après saisir le numéro d'appel. Une correction des chiffres du numéro d'appel, comme décrit plus haut, n'est pas possible quand la communication est établie de cette manière.

3. Pour terminer la conversation, appuyez sur la touche  ou mettez le combiné dans la base.

5.4 Prendre un appel

Votre combiné et la base sonnent. Si vous prenez le combiné de la base, la connexion est alors établie. L'indicateur de communication DEL clignote à la base.

Remarque: Si la mise en communication automatique est désactivée, établissez la connexion en appuyant sur la touche  du combiné.



5.5 Prendre deux appels externes

Des signaux sonores vous feront remarquer (signalisation d'appel en instance) qu'un autre appel vous parvient pendant que vous téléphonez. Vous pouvez voir à l'écran le numéro du deuxième correspondant. Vous pouvez avec la combinaison de touches "R" "2" changer alternativement de correspondant. Un correspondant sera maintenu en ligne pendant que vous parlez avec l'autre correspondant.

Remarque: Pour utiliser les services supplémentaires de la Swisscom, vous devez régler le temps de flash sur 300 ms (voir chapitre "14.4 Régler les temps flash").



Attention : L'affichage du numéro d'appel et la signalisation d'appel en instance sont un service optionnel de votre exploitant de réseau. Votre téléphone affiche les numéros d'appel à l'écran si votre exploitant de réseau offre ce service. Veuillez demander de plus amples informations à votre exploitant de réseau.

5.6 Mains-libres

1. Appuyez de nouveau sur la touche  pendant une communication. Vous entendez maintenant votre correspondant par l'intermédiaire du haut parleur de votre combiné.
2. Appuyez de nouveau sur la touche  pour enlever la fonction mains-libres.

5.7 Composition des numéros d'appel du répertoire

Après que vous ayez enregistré vos numéros d'appel dans le répertoire (voir "Saisie des numéros d'appel dans le répertoire", chapitre 8.1), ces derniers peuvent être consultés rapidement et facilement.

1. Appuyez sur la touche . Les enregistrements du répertoire apparaissent à l'écran dans l'ordre alphabétique.
2. Vous pouvez sélectionner un enregistrement du répertoire en appuyant sur les touches  ou .

Remarque: Pour sélectionner directement un enregistrement, appuyez sur la touche qui correspond à la première lettre de l'enregistrement. Pour accéder directement au nom "Peter", appuyez une fois sur la touche .

3. Appuyez maintenant sur la touche  et le numéro d'appel désiré sera automatiquement composé.

5.8 Affichage de la durée de la communication

Pendant la communication, la durée de la communication est indiquée en minutes et en secondes à l'écran après 15 secondes ainsi que le numéro d'appel de l'interlocuteur.

5.9 Réglage du volume sonore de l'écouteur



Si le volume sonore de l'écouteur est trop faible ou trop fort, vous pouvez adapter celui-ci en fonction de vos désirs.

Appuyez pendant une communication sur les touches  ou  pour régler le volume sur l'un des cinq niveaux.

5.10 Rappel

Voir "Numéros composés (rappel)" chapitre 10.4.

5.11 Désactiver le microphone du combiné

La touche  vous permet pendant une communication téléphonique de désactiver le microphone du combiné. "Silencieux" s'affiche à l'écran. Il est donc possible de parler à une tierce personne sans que le correspondant puisse vous entendre. Le haut-parleur du combiné reste branché si bien que vous pouvez continuer à entendre le correspondant. En appuyant sur la touche , le microphone est de nouveau activé.

5.12 Branchement / débranchement du combiné

Pour activer ou désactiver le combiné, appuyez 2 sec. sur la touche . L'écran s'éteint ou s'allume.

5.13 Chercher un combiné (paging)



Si vous avez égaré votre combiné, vous pouvez le rechercher à l'aide de la base.

1. Appuyez sur la touche paging  de la base. Tous les combinés appartenant à la base sonnent.
2. Pour achever la recherche, réappuyez sur la touche paging de la base ou sur une des touches du combiné.



5.14 Verrouillage du clavier

Si vous portez souvent le combiné sur vous, vous pouvez verrouiller le clavier afin que les touches ne puissent pas être actionnées involontairement. Quand le verrouillage des touches est activé, il est possible de répondre aux communications qui arrivent.

5.14.1 Activation du verrouillage des touches

Appuyez pendant trois secondes sur la touche  du combiné. A l'écran s'affichent "verrouillage des touches" et le symbole .

5.14.2 Désactivation du verrouillage des touches

Pour désactiver le blocage des touches, appuyez sur la touche  et confirmez en appuyant normalement sur la touche .

5.15 Remarque concernant la portée

La portée du combiné est d'env. 50 mètres en pièces fermées et d'env. 300 mètres à l'extérieur. Dans le cas d'une bonne connexion avec la base, le symbole  apparaît à l'écran.

Remarque: Si vous vous êtes trop éloigné de la base, le symbole  clignote et vous entendez un avertissement sonore. Rapprochez vous de la base sinon la communication sera interrompue.

6 Installations à postes / services supplémentaires

Vous pouvez vous servir de la touche **R** de votre téléphone sur des installations à postes supplémentaires et si vous utilisez les services supplémentaires de la Swisscom.

6.1 Touche R de mise en attente avec les installations à postes supplémentaires

Si votre téléphone est raccordé à une installation à postes supplémentaires, vous pouvez, par l'intermédiaire de la touche **R**, tirer profit de toutes les possibilités comme par ex. le transfert d'appels, le rappel automatique etc. Un temps de flash de 100 ms est nécessaire avec une installation à postes supplémentaires (réglage : voir chapitre 14.4). Votre revendeur, chez lequel vous avez acheté l'installation, vous dira si votre téléphone fonctionne impeccablement sur votre installation à postes supplémentaires.

6.2 Touche R de mise en attente et les services supplémentaires de la Swisscom

Votre téléphone SWITEL soutient les services supplémentaires les plus importants de la Swisscom (par ex. le va-et-vient, la signalisation d'appel en instance, la conférence à trois). La Swisscom travaille avec un temps de flash de 300 ms (réglage : voir chapitre 14.4). Pour le branchement des services supplémentaires, veuillez vous adresser à la Swisscom.

6.3 Pause de numérotation

Dans le cas d'installations à postes supplémentaires, il est nécessaire de composer un certain numéro (par ex. le "9" ou le "0") pour obtenir la tonalité de la ligne principale. Sur les quelques installations à postes supplémentaires plus anciennes, cela dure un peu plus longtemps jusqu'à ce que l'on puisse entendre la tonalité. Spécialement pour ces installations à postes supplémentaires, on peut, après la prise de ligne, introduire une pause automatique afin de pouvoir continuer à composer directement le numéro sans devoir attendre la tonalité.

Appuyez une fois sur la touche **^** pendant env. 2 secondes entre le code réseau et le numéro d'appel propre. L'affichage "P" apparaît sur l'écran. Après la prise de ligne, votre téléphone attend 3 secondes pour composer le numéro d'appel propre.

Remarque: La pause peut également être enregistrée dans le répertoire lors de la saisie de numéros d'appel.

- Structure du menu -

7 Structure du menu

Vous trouverez ci-dessous la structure du menu de votre téléphone. En mode veille, ouvrez la sélection du menu avec la touche . Pour plus de clarté, les niveaux de chacun des points du menu ne sont pas tous toujours représentés.

SMS	Ecrire un message	Options	Envoyer à	Chercher
			Enregistrer	
			Insérer symbole	
			Nom Utilisateur	
	Réception	Lire	Options	Répondre
				Transférer
				Effacer
	Archive	Lire	Options	Modifier
				Envoyer à
				Effacer
			Nom Utilisateur	
Effacer messages	Réception			
	Archive			
	Effacer tout			
Réglages	Centres Serveurs	Serveur Réception		
		Serveur Emission		
	Numéro de Terminal			
	Alertes			
	Boîtes personnelles			
Liste des appels	Appels reçus	Options	Effacer	
			Voir les détails	
			Ajouter aux contacts	
	Appels non répondus	Options	Effacer	
			Voir les détails	
			Ajouter aux contacts	
	Numéros composés	Options	Effacer	
			Voir les détails	
			Ajouter aux contacts	
Effacer listes	Appels reçus			
	Appels non répondus			
	Numéros composés			
	Tous les appels			

- Structure du menu -

Combiné	Sonnerie	Appels externes
		Appels internes
	Volume de sonnerie	
	Nom du combiné	
	Choix langue	
	Couleurs du menu	
	Décroché automatique	
Code d'accès		

Configuration base	Sonnerie base			
	Volume base			
	Priorité de sonnerie	Tous les combinés		
		Sélection combiné	Combiné 1-5	Sonneries 2
				Sonneries 4
	Touche R			Sonneries 6
	Code base (préréglage : 0000)			

Réglage date & heure	Alarme	Marche/arrêt	Une seule sonnerie
		Sonnerie alarme	Quotidienne
		Sonnerie alarme 1-4	Arrêt
	Réglage date & heure	Date	Heure

Enregistrement	Déclaration combiné	Base 1	Code Base (préréglage : 0000)
		Base 2	
		Base 3	
		Base 4	
	Choix de la base	Automatique	
		Base 1	
		Base 2	
		Base 3	
		Base 4	
	Suppression Combiné	Code Base (préréglage : 0000)	





8 Le répertoire

En mode de veille, vous accédez au menu du répertoire par la touche . Vous pouvez enregistrer 150 numéros d'appel, nom inclus, dans le répertoire. Pour la saisie d'un nom, vous avez 16 caractères à votre disposition. La longueur maximale d'un numéro d'appel est de 20 caractères.



8.1 Saisie d'un numéro d'appel dans le répertoire

1. Appuyez sur la touche . Le répertoire apparaît à l'écran.

Remarque: Si vous effectuez votre premier enregistrement dans le répertoire, reportez vous maintenant à l'étape 4.

2. Appuyez sur la touche .
3. Sélectionnez avec les touches  ou  l'option "insérer n" à l'écran.
4. Appuyez sur la touche . Le message "nom" apparaît à l'écran
5. Saisissez maintenant le nom correspondant par l'intermédiaire du pavé numérique.





Remarque: Saisie de textes : voir 8.1.1.

6. Appuyez sur la touche . Le message "numéro" apparaît à l'écran
7. Saisissez le numéro d'appel désiré par l'intermédiaire du pavé numérique.
8. Appuyez sur la touche . La saisie est confirmée à l'écran.
9. Si vous désirez enregistrer d'autres numéros d'appel, répétez les points 3 à 9.
10. En appuyant sur la touche , le combiné retourne au mode de veille.

8.1.1 Saisie de textes



Pour permettre la saisie de textes, des lettres sont inscrites sur les touches chiffrées. En appuyant plusieurs fois sur la touche correspondante, on peut saisir des lettres ainsi que des chiffres.

Exemple : Vous désirez saisir le nom "Peter".

Appuyez : 1 x sur la touche , 2 x sur la touche , 1 x sur la touche , 2 x sur la touche , 3 x sur la touche .

- Pour introduire un espace, appuyez une fois sur la touche .
- Pour saisir deux fois la même lettre, appuyez sur la lettre correspondante et attendez ensuite que le curseur passe automatiquement à la position suivante.



Remarque: Vous pouvez supprimer les erreurs de saisie avec la touche .

Pour déplacer le curseur vers la gauche ou vers la droite, appuyez sur les touches  ou .





8.1.2 Remarques concernant le répertoire

- Saisissez toujours les numéros d'appel avec l'indicatif afin que le téléphone puisse aussi attribuer les communications locales à un enregistrement du répertoire.
- Si la capacité d'enregistrement de 150 numéros d'appel est atteinte, l'écran affiche le message correspondant lors de l'enregistrement suivant. Pour obtenir de nouveau de la place, vous devez supprimer des enregistrements déjà existants.



8.2 Afficher les détails de l'enregistrement

1. Appuyez sur la touche . Le répertoire apparaît à l'écran.
2. Sélectionnez avec les touches  ou  l'enregistrement souhaité à l'écran.

Remarque: Pour sélectionner directement un enregistrement, appuyez sur la touche qui correspond à la première lettre de l'enregistrement. Pour accéder directement au nom "Peter", appuyez une fois sur la touche .

3. Appuyez sur la touche .
4. Sélectionnez avec les touches  ou  l'option "afficher détails" à l'écran.
5. Appuyez sur la touche . Les noms et le numéro d'appel s'affichent à l'écran.
6. En appuyant sur la touche  vous retournez à chaque fois au niveau supérieur du menu.

8.3 Modification d'enregistrements sauvegardés dans le répertoire

1. Appuyez sur la touche . Le répertoire apparaît à l'écran.
2. Sélectionnez avec les touches  ou  l'enregistrement souhaité à l'écran.





Remarque: Pour sélectionner directement un enregistrement, appuyez sur la touche qui correspond à la première lettre de l'enregistrement. Pour accéder directement au nom "Peter", appuyez une fois sur la touche .

3. Appuyez sur la touche .
4. Sélectionnez avec les touches  ou  l'option "modifier n" à l'écran.



- Le répertoire -

- Appuyez sur la touche .
Le nom apparaît à l'écran. Modifiez au besoin le nom ou reportez vous à l'étape 6.







Remarque: Remarques concernant la saisie du nom au chap. 8.1.1.

- Appuyez sur la touche . Le numéro s'affiche à l'écran. Modifiez au besoin le numéro ou reportez vous à l'étape 7.
- Appuyez sur la touche . La modification est confirmée à l'écran.
- En appuyant une fois sur la touche , vous pouvez retourner au répertoire pour modifier d'autres enregistrements.
- En appuyant sur la touche  vous retournez à chaque fois au niveau supérieur du menu.







8.4 Supprimer un enregistrement du répertoire

- Appuyez sur la touche . Le répertoire apparaît à l'écran.
- Sélectionnez avec les touches  ou  l'enregistrement souhaité à l'écran.

Remarque: Pour sélectionner directement un enregistrement, appuyez sur la touche qui correspond à la première lettre de l'enregistrement. Pour accéder directement au nom "Peter", appuyez une fois sur la touche .

- Appuyez sur la touche .
- Sélectionnez avec les touches  ou  l'option "supprimer n" à l'écran.
- Appuyez sur la touche . La demande de suppression de l'enregistrement apparaît à l'écran.
- Appuyez sur la touche . La suppression est confirmée à l'écran.
- En appuyant sur la touche  le combiné retourne au mode de veille.



8.5 Suppression de tous les enregistrements du répertoire

- Appuyez sur la touche . Le répertoire apparaît à l'écran.
- Appuyez sur la touche .
- Sélectionnez avec les touches  ou  l'option "supprimer rubrique" à l'écran.
- Appuyez sur la touche . La demande de suppression de tous les enregistrements apparaît à l'écran.
- Appuyez sur la touche . La suppression est confirmée à l'écran. Vous pouvez au besoin saisir de nouveaux enregistrements dans le répertoire.
- En appuyant sur la touche  le combiné retourne au mode de veille.









8.6 Appel VIP (attribution d'une sonnerie d'appel)

Vous pouvez attribuer des sonneries d'appel spéciales pour les correspondants du répertoire particulièrement importants pour vous. Vous pouvez alors savoir de suite qui vous appelle.



8.6.1 Attribuer une mélodie d'appel

- Appuyez sur la touche . Le répertoire apparaît à l'écran.
- Sélectionnez avec les touches  ou  l'enregistrement souhaité à l'écran.









Remarque: Pour sélectionner directement un enregistrement, appuyez sur la touche qui correspond à la première lettre de l'enregistrement. Pour accéder directement au nom "Peter", appuyez une fois sur la touche .

- Appuyez sur la touche .
- Sélectionnez avec les touches  ou  l'option "sonnerie d'appel" à l'écran.
- Appuyez sur la touche . Un choix de plusieurs mélodies apparaît à l'écran.
- Sélectionnez avec les touches  ou  la mélodie désirée à l'écran.
- Appuyez sur la touche . L'attribution est confirmée à l'écran.
- En appuyant sur la touche  vous retournez à chaque fois au niveau supérieur du menu.

8.6.2 Désactivation de l'attribution d'une sonnerie d'appel

- Appuyez sur la touche . Le répertoire apparaît à l'écran.
- Sélectionnez avec les touches  ou  l'enregistrement désiré à l'écran.

Remarque: Pour sélectionner directement un enregistrement, appuyez sur la touche qui correspond à la première lettre de l'enregistrement. Pour accéder directement au nom "Peter", appuyez une fois sur la touche .

- Appuyez sur la touche . Plusieurs options apparaissent à l'écran.
- Sélectionnez avec les touches  ou  l'option "sonnerie d'appel" à l'écran.
- Appuyez sur la touche . Un choix de plusieurs mélodie et l'option "désactivé" apparaissent à l'écran.
- Sélectionnez avec les touches  ou  l'option "désactivé" à l'écran.
- Appuyez sur la touche . L'attribution est confirmée à l'écran.
- En appuyant sur la touche  vous retournez à chaque fois au niveau supérieur du menu.

9 Messages SMS

Conditions générales

Il est possible de communiquer également par message (SMS) à partir du réseau fixe. Vous pouvez envoyer et recevoir des messages (SMS). Pour pouvoir envoyer et recevoir des messages, certaines conditions sont nécessaires.

- Votre raccordement téléphonique doit disposer du service supplémentaire CLIP (Calling Line Identification Presentation). Assurez vous auprès de votre exploitant du réseau que ce service soit bien activé sur votre raccordement téléphonique. Ce service peut être payant et doit être demandé le cas échéant à votre exploitant du réseau (p. ex. Swisscom au numéro 0800800800).
- Les numéros 0190 doivent être possibles avec votre raccordement au réseau fixe.
- Pour utiliser le service SMS, celui-ci doit être activé auprès de votre exploitant du réseau.

Remarque: Les envois SMS ne sont pas encore possibles avec les connexions call by call.

- Les envois de messages SMS sont payant.
- Si le récepteur n'utilise pas de service SMS sur son réseau fixe ou si son téléphone ne peut pas recevoir simplement de messages, le SMS sera automatiquement livré sous forme de message vocal et lu au téléphone.
- Le calcul des frais est effectué par l'exploitant du réseau.

En raison des avancées continues de la technologie, il se peut que les données indiquées puissent être modifiées. Vous trouverez les informations sur les modifications par l'intermédiaire des pages internet ou les numéros de service de votre exploitant du réseau.

9.1 Centre de service

La distribution des messages SMS se fait par un centre de service. "Swisscom", "cablecom" et d'autres exploitants du réseau proposent ce service. Votre téléphone SWITEL possède déjà la fonction (envoi et réception de messages SMS) avec "Swisscom" et "cablecom".

Centre de service de "Swisscom"

- Le numéro du centre de service de la "Swisscom" est le 0622 100 000.
- La fonction SMS de la "Swisscom" est déjà activée pour vous. Vous n'avez pas besoin de la déclarer.

















Centre de service de "cablecom"

- Le numéro du centre de service de "cablecom" est le 0435 375 370.
- La fonction SMS de la "cablecom" est déjà activée pour vous. Vous n'avez pas besoin de la déclarer.

Deux numéros d'appel SMS peuvent être programmés sur votre combiné : un numéro d'appel pour l'envoi et un numéro d'appel pour la réception de messages SMS. Si vous voulez utiliser le service d'un autre prestataire, vous devez programmer le(s) numéro(s) de celui-ci sur le combiné. Procédez pour cela comme décrit au chap 9.1.1.

Remarque: La procédure de déclaration varie en fonction des prestataires. Veuillez demander auprès du prestataire de votre choix le numéro nécessaire ainsi que la démarche à suivre pour activer le service SMS.

9.1.1 Saisie du numéro d'envoi et de réception

1. Appuyez sur la touche .
2. Sélectionnez avec les touches  ou  le point du menu "SMS" à l'écran.
3. Appuyez sur la touche .
4. Sélectionnez avec les touches  ou  l'option "paramétrages" à l'écran.
5. Appuyez sur la touche .
6. Sélectionnez avec les touches  ou  l'option "centre de service" à l'écran.
7. Appuyez sur la touche .
8. Sélectionnez avec les touches  ou  + l'option "CS réception" à l'écran. Saisissez le numéro d'appel fourni par le prestataire de votre choix.
9. Appuyez sur la touche .
10. Sélectionnez avec les touches  ou  l'option "CS envoi" à l'écran. Saisissez le numéro d'appel fourni par le prestataire de votre choix.
11. Appuyez sur la touche .
12. En appuyant sur la touche  vous retournez à chaque fois au niveau supérieur du menu.

9.2 Ecrire et envoyer

Remarque: L'envoi d'un message SMS n'est pas possible à partir d'une installation à postes supplémentaires. Pour envoyer le message SMS, le "code d'accès" doit être désactivé (voir chapitre 11.7).

1. Appuyez sur la touche .

- Messages SMS -

2. Sélectionnez avec les touches ou le point du menu "SMS" à l'écran.
3. Appuyez sur la touche .
4. Sélectionnez avec les touches ou l'option "écrire message" à l'écran.
5. Appuyez sur la touche . Saisissez maintenant le texte par l'intermédiaire du pavé numérique. 160 caractères max. sont possibles.

Remarque: Saisie de textes : voir 8.1.1.

Remarque: Pour insérer un symbole, appuyez pendant la saisie du message sur la touche . Sélectionnez avec les touches ou l'option "insérer symbole" à l'écran. Appuyez sur la touche . Sélectionnez avec les touches ou le symbole désiré. Appuyez sur la touche . La saisie du texte est de nouveau à l'écran. Complétez votre texte.

6. Appuyez sur la touche .
7. Sélectionnez avec les touches ou l'option "envoyer à" à l'écran.

Remarque: Si vous souhaitez envoyer le message SMS ultérieurement, sélectionnez à l'étape 7 l'option "enregistrer". Votre message SMS est enregistré dans la liste "sortie".

8. Appuyez sur la touche .
9. Saisissez le numéro d'appel du récepteur.
Si le récepteur est enregistré dans votre répertoire, appuyez sur la touche . Sélectionnez avec les touches ou le récepteur souhaité puis appuyez sur la touche . Allez à l'étape 10.
10. Appuyez sur la touche . L'envoi est confirmé à l'écran.

9.3 Envoyer un message SMS enregistré

1. Appuyez deux fois sur la touche .
2. Sélectionnez avec les touches ou l'option "sortie" à l'écran.
3. Appuyez sur la touche .
4. Sélectionnez avec les touches ou le message SMS désiré à l'écran.
5. Appuyez deux fois sur la touche .
6. Sélectionnez avec les touches ou l'option "envoyer à" à l'écran.
7. Appuyez sur la touche .
8. Saisissez le numéro d'appel du récepteur puis appuyez sur la touche .

9.4 Lire et répondre

Dès qu'un message SMS est reçu, vous entendez un signal sonore et l'écran affiche l'entrée d'un nouveau message.

1. Appuyez sur la touche . La liste d'entrée apparaît à l'écran. Les messages SMS pas encore lus sont indiqués avec une étoile.

Remarque: Si vous souhaitez répondre à un message SMS déjà lu, appuyez deux fois sur la touche , sélectionnez avec les touches ou l'option "entrée" à l'écran et appuyez sur la touche . Allez à l'étape 2.

2. Sélectionnez avec les touches ou le message SMS désiré à l'écran.
3. Appuyez sur la touche . Le message SMS apparaît à l'écran.
4. Appuyez sur la touche .
5. Sélectionnez avec les touches ou l'option "répondre" à l'écran.
Sélectionnez l'option "transférer" pour transférer le message SMS. Pour transférer le message SMS, reportez vous à l'étape 8.
6. Appuyez sur la touche . Saisissez maintenant le texte par l'intermédiaire du pavé numérique. 160 caractères max. sont possibles.

















Remarque: Saisie de textes : voir 8.1.1.

7. Appuyez sur la touche .
8. Sélectionnez avec les touches ou l'option "envoyer à" à l'écran.
9. Appuyez sur la touche .
10. Saisissez le numéro d'appel du récepteur.
Si le récepteur est enregistré dans votre répertoire, appuyez sur la touche . Sélectionnez avec les touches ou le récepteur souhaité puis appuyez sur la touche .
11. Appuyez sur la touche . L'envoi est confirmé à l'écran.

9.5 Activer/désactiver la sonnerie du message















1. Appuyez sur la touche .
2. Sélectionnez avec les touches ou le point du menu "SMS" à l'écran.
3. Appuyez sur la touche .
4. Sélectionnez avec les touches ou l'option "paramétrages" à l'écran.
5. Appuyez sur la touche .
6. Sélectionnez avec les touches ou l'option "sonnerie messages" à l'écran.
7. Appuyez sur la touche .
8. Sélectionnez avec les touches ou les options "activé" ou "désactivé" à l'écran.
9. Appuyez sur la touche .
10. En appuyant sur la touche vous retournez à chaque fois au niveau supérieur du menu.

9.6 Régler la sonnerie du message (sonnerie morse, discrète, polyphone)

1. Appuyez sur la touche .
2. Sélectionnez avec les touches  ou  le point du menu "SMS" à l'écran.
3. Appuyez sur la touche .
4. Sélectionnez avec les touches  ou  l'option "paramétrages" à l'écran.
5. Appuyez sur la touche .
6. Sélectionnez avec les touches  ou  l'option "sonnerie messages" à l'écran.
7. Appuyez sur la touche .
8. Sélectionnez avec les touches  ou  l'option "régler sonnerie d'alarme" à l'écran.
9. Appuyez sur la touche .
10. Sélectionnez avec les touches  ou  le type désiré de sonnerie à l'écran.
11. Appuyez sur la touche . La modification est confirmée à l'écran.

9.7 Supprimer un message SMS



Vous pouvez supprimer chacun des messages SMS situés dans les classeurs "entrée" et "sortie".



1. Appuyez sur la touche .
2. Sélectionnez avec les touches  ou  le point du menu "SMS" à l'écran.
3. Appuyez sur la touche .
4. Sélectionnez avec les touches  ou  les options "entrée" ou "sortie" à l'écran.
5. Appuyez sur la touche .
6. Sélectionnez avec les touches  ou  le SMS désiré à l'écran.
7. Appuyez sur la touche .
8. Appuyez sur la touche  puis sélectionnez l'option "supprimer".
9. Appuyez sur la touche .
10. Appuyez sur la touche  pour confirmer la suppression.
11. En appuyant sur la touche  vous retournez à chaque fois au niveau supérieur du menu.

9.8 Supprimer tous les messages SMS

Les messages SMS se trouvant dans les listes "entrée" et "sortie" peuvent être supprimés tous en même temps.

1. Appuyez sur la touche .
2. Sélectionnez avec les touches  ou  le point du menu "SMS" à l'écran.
3. Appuyez sur la touche .
4. Sélectionnez avec les touches  ou  l'option "supprimer message" à l'écran.
5. Appuyez sur la touche .
6. Sélectionnez avec les touches  ou  l'option "tous les messages" à l'écran.

Remarque: Si vous souhaitez supprimer les messages SMS situés dans les classeurs "entrée" ou bien "sortie", sélectionnez avec les touches  ou  l'option correspondante à l'écran.

7. Appuyez sur la touche . Une demande de confirmation apparaît à l'écran.
8. Appuyez sur la touche . La suppression est confirmée à l'écran.
9. En appuyant sur la touche  vous retournez à chaque fois au niveau supérieur du menu.

















9.9 Boîte SMS

En plus de la boîte principale déjà existante, vous disposez de quatre autres boîtes et vous pouvez vous protéger par un mot de passe. Chaque boîte comporte un nom d'utilisateur et un numéro ID (chiffres). Cette fonction vous permet de recevoir des SMS qui ne peuvent être lus que par vous.

Remarque: Vous ne pouvez utiliser les boîtes SMS que si l'exploitant du réseau le permet. Veuillez demander le mode de configuration du fonctionnement des boîtes auprès de votre exploitant du réseau.

















9.9.1 Insérer boîte/ utilisateur

Remarque: Vous pouvez insérer jusqu'à 4 utilisateurs.

1. Appuyez sur la touche .
2. Sélectionnez avec les touches  ou  le point du menu "SMS" à l'écran.
3. Appuyez sur la touche .
4. Sélectionnez avec les touches  ou  l'option "paramétrages" à l'écran.
5. Appuyez sur la touche .
6. Sélectionnez avec les touches  ou  l'option "utilisateur" à l'écran.
7. Appuyez sur la touche .
8. Sélectionnez avec les touches  ou  l'option "insérer utilisateur" à l'écran.
9. Appuyez sur la touche . Saisissez les noms des utilisateurs par l'intermédiaire du pavé numérique.
10. Appuyez sur la touche . Saisissez un mot de passe de 5 caractères par l'intermédiaire du pavé numérique.
11. Appuyez sur la touche . Saisissez de nouveau le mot de passe par l'intermédiaire du pavé numérique.
12. Appuyez sur la touche . La boîte est créée.
13. En appuyant sur la touche  vous retournez à chaque fois au niveau supérieur du menu.

9.9.2 Afficher les données d'une boîte/ d'un utilisateur

Remarque: Pour la configuration du fonctionnement de la boîte auprès de l'exploitant du réseau, vous nécessitez un numéro ID (chiffre de numérotation). La boîte générale a le numéro ID "0". Lors de l'inscription d'autres utilisateurs, le plus petit numéro ID libre (1-4) est automatiquement attribué.

1. Appuyez sur la touche .
2. Sélectionnez avec les touches  ou  le point du menu "SMS" à l'écran.
3. Appuyez sur la touche .
4. Sélectionnez avec les touches  ou  l'option "paramétrages" à l'écran.
5. Appuyez sur la touche .
6. Sélectionnez avec les touches  ou  l'option "utilisateur" à l'écran.
7. Appuyez sur la touche .
8. Sélectionnez avec les touches  ou  l'utilisateur désiré à l'écran.
9. Appuyez sur la touche . Saisissez le mot de passe correspondant.
10. Appuyez sur la touche .
11. Sélectionnez avec les touches  ou  l'option "numéro appareil" à l'écran.
12. Appuyez sur la touche . Le numéro de l'appareil s'affiche.

Remarque: Le numéro de l'appareil affiché à l'étape 12 correspond pour l'exploitant du réseau au numéro ID.

13. En appuyant sur la touche  vous retournez à chaque fois au niveau supérieur du menu.

9.9.3 Envoyer un message SMS à la boîte personnelle



















Remarque: Vous ne pouvez utiliser les boîtes SMS que si l'exploitant du réseau le permet. Veuillez demander le mode de configuration du fonctionnement des boîtes auprès de votre exploitant du réseau.

Pour faire parvenir un SMS à la boîte personnelle, l'expéditeur doit connaître votre numéro ID et l'associer à votre numéro.



















Vous pouvez envoyer à votre partenaire SMS un SMS par l'intermédiaire de votre boîte.

Votre partenaire SMS obtient ainsi votre numéro d'appel SMS avec le numéro actuel ID et peut enregistrer celui-ci dans un répertoire. Si le numéro ID n'est pas valable, le SMS ne sera pas livré.

9.9.4 Modifier les données d'une boîte/ d'un utilisateur

1. Appuyez sur la touche .
2. Sélectionnez avec les touches  ou  le point du menu "SMS" à l'écran.
3. Appuyez sur la touche .
4. Sélectionnez avec les touches  ou  l'option "paramétrages" à l'écran.
5. Appuyez sur la touche .
6. Sélectionnez avec les touches  ou  l'option "utilisateur" à l'écran.
7. Appuyez sur la touche .
8. Sélectionnez avec les touches  ou  l'utilisateur désiré à l'écran.
9. Appuyez sur la touche . Saisissez le mot de passe correspondant.
10. Appuyez sur la touche .
11. Sélectionnez avec les touches  ou  une des options que vous souhaitez modifier.
12. Appuyez sur la touche . Modifier le paramétrage.
13. Appuyez sur la touche . Vous pouvez maintenant effectuer d'autres modifications.
14. En appuyant sur la touche  vous retournez à chaque fois au niveau supérieur du menu.

9.9.5 Supprimer une boîte/ un utilisateur

1. Appuyez sur la touche .
2. Sélectionnez avec les touches  ou  le point du menu "SMS" à l'écran.
3. Appuyez sur la touche .
4. Sélectionnez avec les touches  ou  l'option "paramétrages" à l'écran.
5. Appuyez sur la touche .
6. Sélectionnez avec les touches  ou  l'option "utilisateur" à l'écran.
7. Appuyez sur la touche .
8. Sélectionnez avec les touches  ou  l'option "supprimer utilisateur" à l'écran.
9. Appuyez sur la touche .
10. Sélectionnez avec les touches  ou  l'utilisateur désiré.
11. Appuyez sur la touche . Saisissez le PIN du système (préréglage = 0000).
12. Appuyez sur la touche .
13. En appuyant sur la touche  vous retournez à chaque fois au niveau supérieur du menu.

10 Journaux des appels

10.1 Affichage du numéro d'appel (CLIP)

L'affichage du numéro d'appel vous permet de savoir qui vous appelle à l'arrivée d'une communication. Si cette fonction est à votre disposition dans votre ligne téléphonique, l'écran vous indique le numéro du correspondant dès que le téléphone sonne. Si le correspondant a verrouillé son numéro d'appel, le numéro d'appel ne peut pas s'afficher. Si vous avez enregistré ce numéro d'appel dans votre répertoire, le nom sera affiché au lieu du numéro d'appel.











Les journaux "appels répondus" et "appels manqués" ont une mémoire commune de 50 numéros d'appels. Si 32 numéros d'appels sont enregistrés dans le journal des "appels répondus", les "appels manqués" n'ont plus qu'une mémoire de 18 numéros d'appels. Dès que tous les 50 numéros sont atteints, le plus ancien enregistrement est alors supprimé.

Remarque: L'affichage du numéro d'appel est un service optionnel de votre exploitant de réseau. Votre téléphone affiche les numéros d'appel à l'écran si votre exploitant de réseau offre ce service. L'affichage de la date et de l'heure n'est pas fourni par tous les exploitants de réseau. Veuillez demander de plus amples informations à votre exploitant de réseau. Même dans le cas de certaines installations à postes supplémentaires, un transfert du numéro d'appel ou même de la date et de l'heure n'est pas possible.













10.2 Appels répondus



Le journal des "appels répondus" enregistre tous les appels qui ont été acceptés.



10.2.1 Afficher et rappeler

1. Appuyez sur la touche .
2. Sélectionnez avec les touches  ou  le point du menu "journaux des appels" à l'écran.
3. Appuyez sur la touche .
4. Sélectionnez avec les touches  ou  l'option "appels répondus" à l'écran.
5. Appuyez sur la touche . Les appels répondus s'affichent à l'écran.
6. Si vous souhaitez rappeler un appel déjà répondu, sélectionnez avec les touches  ou  le numéro désiré à l'écran.
7. Appuyez sur la touche . La liaison est établie.

10.2.2 Supprimer l'enregistrement















1. Appuyez sur la touche .
2. Sélectionnez avec les touches  ou  le point du menu "journaux des appels" à l'écran.
3. Appuyez sur la touche .
4. Sélectionnez avec les touches  ou  l'option "appels répondus" à l'écran.
5. Appuyez sur la touche . Les appels répondus s'affichent à l'écran.
6. Sélectionnez avec les touches  ou  le numéro désiré à l'écran.
7. Appuyez sur la touche .
8. Sélectionnez avec les touches  ou  l'option "supprimer" à l'écran.

Remarque: En plus de l'option "supprimer", vous disposez de l'option "afficher détails". Si vous sélectionnez "afficher détails", le nom et le numéro s'affichent à l'écran en appuyant sur la touche . En appuyant sur la touche  vous retournerez au journal des "appels répondus".

9. Appuyez sur la touche . La suppression est confirmée à l'écran.
10. Le combiné retourne au journal des "appels répondus".
11. Si vous désirez supprimer d'autres enregistrements, répétez les points 6 à 9.
12. En appuyant sur la touche  vous retournez à chaque fois au niveau supérieur du menu.



10.2.3 Enregistrer l'enregistrement dans le répertoire

Un numéro d'appel du journal des "appels répondus" peut être enregistré directement dans le répertoire.







1. Appuyez sur la touche .
2. Sélectionnez avec les touches  ou  le point du menu "journaux des appels" à l'écran.
3. Appuyez sur la touche .
4. Sélectionnez avec les touches  ou  l'option "appels répondus" à l'écran.
5. Appuyez sur la touche . Les appels répondus s'affichent à l'écran.
6. Sélectionnez avec les touches  ou  le numéro désiré à l'écran.
7. Appuyez sur la touche .
8. Sélectionnez avec les touches  ou  + l'option "insérer n°" à l'écran.
9. Appuyez sur la touche .
10. Saisissez maintenant le nom correspondant par l'intermédiaire du pavé numérique.
11. Appuyez deux fois sur la touche . La saisie est confirmée à l'écran.
12. En appuyant sur la touche  vous retournez à chaque fois au niveau supérieur du menu.

10.3 Appels manqués



Le journal "appels manqués" enregistre tous les appels qui n'ont pas été acceptés pour que vous ne ratiez aucun appel en votre absence. Vous avez 3 possibilités pour accéder au journal des "appels manqués" :

- Appuyez sur la touche  ou,
- si l'écran affiche que l'appel a été manqué, appuyez sur la touche  ou
- reportez vous au chapitre 10.3.1.







10.3.1 Afficher et rappeler

1. Appuyez sur la touche .
2. Sélectionnez avec les touches  ou  le point du menu "journaux des appels" à l'écran.
3. Appuyez sur la touche .
4. Sélectionnez avec les touches  ou  l'option "appels manqués" à l'écran.
5. Appuyez sur la touche . Les appels manqués s'affichent à l'écran.



Remarque: Les nouvelles entrées sont marquées avec une étoile.



6. Si vous souhaitez rappeler un appel manqué, sélectionnez avec les touches  ou  le numéro désiré à l'écran.
7. Appuyez sur la touche . La liaison est établie.

10.3.2 Supprimer l'enregistrement

1. Appuyez sur la touche . Les appels manqués s'affichent à l'écran.
2. Sélectionnez avec les touches  ou  le numéro désiré à l'écran.
3. Appuyez sur la touche .
4. Sélectionnez avec les touches  ou  l'option "supprimer" à l'écran.









Remarque: En plus de l'option "supprimer", vous disposez de l'option "afficher détails".

Si vous sélectionnez "afficher détails", le nom et le numéro s'affichent à l'écran en appuyant sur la touche . En appuyant sur la touche  vous retournerez au journal des "appels manqués".

5. Appuyez sur la touche . La suppression est confirmée à l'écran.
6. En appuyant sur la touche  , le combiné retourne en mode de veille.

10.3.3 Enregistrer l'enregistrement dans le répertoire

Un numéro d'appel du journal des "appels manqués" peut être enregistré directement dans le répertoire.

1. Appuyez sur la touche . Les appels manqués s'affichent à l'écran.
2. Sélectionnez avec les touches  ou  le numéro désiré à l'écran.
3. Appuyez sur la touche .
4. Sélectionnez avec les touches  ou  l'option "insérer n" à l'écran.
5. Appuyez sur la touche . Saisissez les noms par l'intermédiaire du pavé numérique.
6. Appuyez deux fois sur la touche . La saisie est confirmée à l'écran.
7. En appuyant sur la touche  , le combiné retourne en mode de veille.

Remarque: Dès que le numéro d'appel a été enregistré avec un nom dans le répertoire, ce n'est plus le numéro d'appel qui apparaît dans le journal des appels mais le nom enregistré.



10.4 Numéros composés (appel)

Le journal "numéros composés" enregistre tous les numéros que vous avez composés.







10.4.1 Afficher et appeler

1. Appuyez sur la touche . Les appels composés s'affichent à l'écran.



Remarque: Si un numéro est enregistré dans le répertoire, le nom est également affiché.



2. Si vous souhaitez appeler un numéro composé, sélectionnez avec les touches  ou  le numéro désiré à l'écran.
3. Appuyez sur la touche . La liaison est établie.

10.4.2 Supprimer l'enregistrement

1. Appuyez sur la touche . Les appels composés s'affichent à l'écran.
2. Sélectionnez avec les touches  ou  le numéro désiré à l'écran.
3. Appuyez sur la touche .
4. Sélectionnez avec les touches  ou  l'option "supprimer" à l'écran.







Remarque: En plus de l'option "supprimer", vous disposez de l'option "afficher détails".

Si vous sélectionnez "afficher détails", le nom et le numéro s'affichent à l'écran en appuyant sur la touche . En appuyant sur la touche  vous retournerez au journal des "appels manqués".



5. Appuyez sur la touche . La suppression est confirmée à l'écran.
6. En appuyant sur la touche  vous retournez à chaque fois au niveau supérieur du menu.

10.4.3 Enregistrer l'enregistrement dans le répertoire

Un numéro d'appel du journal des "appels composés" peut être enregistré directement dans le répertoire.

1. Appuyez sur la touche . Les appels composés s'affichent à l'écran.
2. Sélectionnez avec les touches  ou  le numéro désiré à l'écran.
3. Appuyez sur la touche .
4. Sélectionnez avec les touches  ou  l'option "insérer n" à l'écran.

- Journaux des appels -











5. Appuyez sur la touche . Saisissez les noms par l'intermédiaire du pavé numérique.
6. Appuyez deux fois sur la touche . La saisie est confirmée à l'écran.
7. En appuyant sur la touche  vous retournez à chaque fois au niveau supérieur du menu.

Remarque: Dès que le numéro d'appel a été enregistré avec un nom dans le répertoire, ce n'est plus le numéro d'appel qui apparaît dans le journal des appels mais le nom enregistré.



10.4.4 Supprimer un journal des appels

Vous avez la possibilité de supprimer tous les enregistrements d'un journal des appels de votre choix ("appels répondus", "appels manqués" ou "numéros composés").

Remarque: La marche à suivre est identique à celle du journal des appels "appels répondus". La marche à suivre concerne également les journaux des "appels manqués" et "numéros composés".











1. Appuyez sur la touche .
2. Sélectionnez avec les touches  ou  le point du menu "journaux des appels" à l'écran.
3. Appuyez sur la touche .
4. Sélectionnez avec les touches  ou  l'option "supprimer journal des appels" à l'écran.
5. Appuyez sur la touche .
6. Sélectionnez avec les touches  ou  l'option "appels répondus" à l'écran.
7. Appuyez sur la touche .
8. Appuyez sur la touche . La demande de suppression du journal des appels apparaît à l'écran.

Remarque: A la prochaine étape, tous les enregistrements sont supprimés immédiatement dans le journal des "appels répondus". En appuyant sur la touche , vous interrompez l'opération de suppression.



9. Appuyez sur la touche . La suppression est confirmée à l'écran.
10. En appuyant sur la touche  vous retournez à chaque fois au niveau supérieur du menu.

10.4.5 Supprimer tous les journaux des appels

Vous avez la possibilité de supprimer tous les enregistrements dans tous les journaux des appels ("appels répondus", "appels manqués" et "numéros composés").

1. Appuyez sur la touche .
2. Sélectionnez avec les touches  ou  le point du menu "journaux des appels" à l'écran.
3. Appuyez sur la touche .
4. Sélectionnez avec les touches  ou  l'option "supprimer journal des appels" à l'écran.
5. Appuyez sur la touche .
6. Sélectionnez avec les touches  ou  l'option "tous les appels" à l'écran.
7. Appuyez sur la touche . La demande de suppression de tous les enregistrements apparaît à l'écran.

Remarque: A la prochaine étape, tous les enregistrements sont supprimés immédiatement dans tous les journaux des appels ("appels répondus", "appels manqués" et "numéros composés"). En appuyant sur la touche , vous interrompez l'opération de suppression.















8. Appuyez sur la touche . La suppression est confirmée à l'écran.
9. En appuyant sur la touche  vous retournez à chaque fois au niveau supérieur du menu.

11 Combiné









Vous pouvez effectuer au choix plusieurs paramétrages sur votre combiné.

11.1 Attribution d'une mélodie d'appel (appels internes et externes)



Vous pouvez attribuer plusieurs mélodies d'appel selon si l'appel est interne ou externe. Le paramétrage décrit ici est valable aussi pour les appels externes.

1. Appuyez sur la touche .
2. Sélectionnez avec les touches  ou  le point du menu "combiné" à l'écran.
3. Appuyez sur la touche . Plusieurs options apparaissent à l'écran.
4. Sélectionnez avec les touches  ou  l'option "sonnerie d'appel".
5. Appuyez sur la touche .
6. Sélectionnez avec les touches  ou  l'option "appels externes".
7. Appuyez sur la touche . Un choix de plusieurs mélodies apparaît à l'écran.
8. Sélectionnez avec les touches  ou  la mélodie désirée.
9. Appuyez sur la touche . L'attribution est confirmée à l'écran.
10. En appuyant sur la touche  vous retournez à chaque fois au niveau supérieur du menu.













11.2 Régler le volume de la sonnerie d'appel

1. Appuyez sur la touche .
2. Sélectionnez avec les touches  ou  le point du menu "combiné" à l'écran.
3. Appuyez sur la touche . Plusieurs options apparaissent à l'écran.
4. Sélectionnez avec les touches  ou  l'option "volume sonnerie d'appel".
5. Appuyez sur la touche .
6. Sélectionnez avec les touches  ou  le volume désiré de la sonnerie d'appel.

Remarque: Si vous sélectionnez l'option "volume désactivé", le symbole  apparaît à l'écran.











7. Appuyez sur la touche . L'attribution est confirmée à l'écran.
8. En appuyant sur la touche  vous retournez à chaque fois au niveau supérieur du menu.

11.3 Saisir ou modifier les noms des combinés

1. Appuyez sur la touche .
2. Sélectionnez avec les touches  ou  le point du menu "combiné" à l'écran.
3. Appuyez sur la touche . Plusieurs options apparaissent à l'écran.
4. Sélectionnez avec les touches  ou  l'option "nom combiné".
5. Appuyez sur la touche . Le message "nom" apparaît à l'écran.
6. Saisissez les noms désirés (maximal 8 caractères). Vous pouvez supprimer les erreurs de saisie avec la touche . Pour déplacer le curseur vers la gauche ou vers la droite, appuyez sur les touches  ou .
7. Appuyez sur la touche . L'attribution est confirmée à l'écran.
8. En appuyant sur la touche  vous retournez à chaque fois au niveau supérieur du menu.











11.4 Sélectionner la langue

Vous pouvez faire afficher le texte de l'écran dans différentes langues.

1. Appuyez sur la touche .
2. Sélectionnez avec les touches  ou  le point du menu "combiné" à l'écran.
3. Appuyez sur la touche . Plusieurs options apparaissent à l'écran.
4. Sélectionnez avec les touches  ou  l'option "langue".
5. Appuyez sur la touche . Un choix de plusieurs langues apparaît à l'écran.
6. Sélectionnez avec les touches  ou  la langue désirée.
7. Appuyez sur la touche . L'attribution est confirmée à l'écran.
8. En appuyant sur la touche  vous retournez à chaque fois au niveau supérieur du menu.





11.5 Régler la couleur du menu

Vous pouvez régler les couleurs de l'arrière-plan dans les points du menu.







1. Appuyez sur la touche .
2. Sélectionnez avec les touches  ou  le point du menu "combiné".
3. Appuyez sur la touche . Plusieurs options apparaissent à l'écran.
4. Sélectionnez avec les touches  ou  l'option "couleur menu".
5. Appuyez sur la touche . Un choix de plusieurs couleurs apparaît à l'écran.
6. Sélectionnez avec les touches  ou  la couleur désirée.
7. Appuyez sur la touche . L'attribution est confirmée à l'écran.
8. En appuyant sur la touche  vous retournez à chaque fois au niveau supérieur du menu.

11.6 Activer la mise en communication automatique

Si vous avez activé cette fonction, vous pouvez répondre à un appel en retirant simplement le combiné de sa base. Vous ne devez pas appuyer en plus sur la touche communication .















1. Appuyez sur la touche .
2. Sélectionnez avec les touches  ou  le point du menu "combiné".
3. Appuyez sur la touche . Plusieurs options apparaissent à l'écran.

- Combiné -

4. Sélectionnez avec les touches  ou  l'option "mise en communication automatique".
5. Appuyez sur la touche .
6. Sélectionnez avec les touches  ou  l'option "activé".
7. Appuyez sur la touche . L'attribution est confirmée à l'écran.
8. En appuyant sur la touche  vous retournez à chaque fois au niveau supérieur du menu.









11.7 Activer le code d'accès (indicatif réseau)

Pour certaines installations à postes supplémentaires, vous devez composer en premier un chiffre précis (p. ex. "0" ou "9") avant d'obtenir une tonalité pour une ligne réseau. Si vous saisissez un chiffre, ce chiffre compose automatiquement les numéros de téléphone que vous avez sélectionnés à partir du répertoire ou d'un des journaux d'appels.



1. Appuyez sur la touche .
2. Sélectionnez avec les touches  ou  le point du menu "combiné".
3. Appuyez sur la touche . Plusieurs options apparaissent à l'écran.
4. Sélectionnez avec les touches  ou  l'option "code d'accès".
5. Appuyez sur la touche .
6. Sélectionnez avec les touches  ou  l'option "saisir code".
7. Appuyez sur la touche . L'écran affiche le message "saisir code".
8. Saisissez les chiffres nécessaires (maximal 4 chiffres).
9. Appuyez sur la touche . L'attribution est confirmée à l'écran.
10. Sélectionnez l'option "activé".
11. Appuyez sur la touche . L'attribution est confirmée à l'écran.
12. Si vous souhaitez désactiver l'indicatif automatique, sélectionnez l'option "désactivé" et appuyez sur la touche .
13. En appuyant sur la touche  vous retournez à chaque fois au niveau supérieur du menu.

12 Déclarer et retirer des combinés

12.1 Déclarer un combiné

1. Appuyez sur la touche .
2. Sélectionnez avec les touches  ou  le point du menu "déclaration" à l'écran.
3. Appuyez sur la touche .
4. Sélectionnez avec les touches  ou  l'option "déclarer combiné" à l'écran.
5. Appuyez sur la touche .
6. Sélectionnez avec les touches  ou  l'option "base 1".

Remarque: Si vous souhaitez déclarer votre combiné sur une nouvelle base, sélectionnez une base qui n'est pas marquée avec une étoile. Si la base est marquée avec une étoile, cela signifie que la mémoire est prise.

7. Appuyez sur la touche  et saisissez le PIN.
8. Appuyez sur la touche . L'indication "cherche base" s'affiche à l'écran.
9. Appuyez (env. 5 sec.) sur la touche paging  de la base jusqu'à ce qu'un signal sonore retentisse. La déclaration est mise en route.

Remarque: Pour déclarer un combiné DECT-GAP d'un autre fabricant, suivez les instructions contenues dans le mode d'emploi de l'autre fabricant puis appuyez sur la touche  de la base.









10. Appuyez sur la touche . Le combiné est maintenant déclaré.

Le combiné obtient automatiquement le plus petit numéro libre (1-5).

Le combiné déclaré en premier possède le numéro interne 1. Le deuxième a le numéro interne 2. En mode veille, le numéro interne est affiché à l'écran après le nom du téléphone.











12.2 Retirer un combiné

Remarque: Un combiné ne peut être retiré que par l'intermédiaire d'un autre combiné encore déclaré. Il n'est donc pas possible de retirer le combiné avec le combiné qui doit être retiré.

1. Appuyez sur la touche .
2. Sélectionnez avec les touches  ou  le point du menu "déclaration" à l'écran.
3. Appuyez sur la touche .
4. Sélectionnez avec les touches  ou  l'option "retirer combiné" à l'écran.
5. Appuyez sur la touche . Saisissez le numéro PIN.
6. Appuyez sur la touche . Sélectionnez le combiné à retirer.
7. Appuyez deux fois sur la touche . Le combiné est maintenant retiré.

12.3 Sélectionner base

Si votre combiné est déclaré à plusieurs bases, vous pouvez sélectionner une base fixe ou activer une recherche automatique de la base la plus réceptrice. Pour désactiver la recherche automatique, vous devez sélectionner de nouveau une base fixe.

1. Appuyez sur la touche .
2. Sélectionnez avec les touches  ou  le point du menu "déclaration" à l'écran.
3. Appuyez sur la touche .
4. Sélectionnez avec les touches  ou  l'option "sélectionner base" à l'écran.
5. Appuyez sur la touche .
6. Sélectionnez avec les touches  ou  la base désirée ou "automatique" à l'écran.
7. Appuyez sur la touche . La sélection est confirmée.

13 Plusieurs combinés

Vous pouvez déclarer quatre autres combinés sur votre base. Chaque combiné ne peut être déclaré que sur une seule base. Si vous déclarez votre combiné sur une nouvelle base, celui-ci est automatiquement retiré de l'ancienne.

Remarque: Par l'intermédiaire du GAP standard normé international, il est possible d'intégrer les combinés SWITEL ainsi que les combinés de fabricants autres dans le système téléphonique. De même, vous pouvez déclarer un combiné SWITEL sur des bases d'autres fabricants dans la mesure où ces appareils travaillent d'après le GAP standard.

Dans le cas d'utilisation de deux combinés, vous avez les possibilités suivantes :

- Communications internes entre les combinés
- Des communications peuvent être transférées par le combiné.
- Des communications externes qui vous parviennent sont signalées à tous les combinés.

Remarque: Si l'autre combiné utilise déjà la ligne externe, une autre communication externe n'est pas possible.

GAP : **Generic Access Profile** = Standard pour l'action conjointe de combinés et de bases de fabricants différents.

13.1 Téléphoner à l'intérieur

Si vous avez déclaré plusieurs combinés sur une base, vous pouvez passer des communications internes.

1. Appuyez sur la touche **(INT)** et composez le numéro interne du combiné, p. ex. **(INT) 2**.
2. La communication est reçue sur le combiné appelé.

Remarque: Si un appel externe vous parvient pendant une communication interne, vous entendez de cours signaux sonores et vous voyez à l'écran le numéro d'appel du correspondant si celui-ci est disponible.

3. Terminer la communication interne avec la touche **(S)**.
4. Appuyez sur la touche **(S)** pour prendre l'appel externe.

13.2 Transfert de communications externes à un autre combiné

Si vous avez pris une communication externe sur un combiné, vous pouvez transférer la communication externe sur un autre combiné.

Appuyez pour cela sur la touche **(INT)** puis composez le numéro interne du combiné désiré.

Remarque: Si le combiné appelé ne réagit pas, vous pouvez reprendre la communication en appuyant sur **(INT)**.

Après que la communication interne ait été prise par l'autre combiné, vous avez les possibilités suivantes :

1. **L'intercommunication / le va-et-vient** : Vous pouvez maintenant parler avec le correspondant interne et revenir au correspondant externe en appuyant sur la touche **(INT)**. Vous pouvez passer aussi souvent que vous le désirez d'une communication externe à une communication interne.
2. **Le transfert de la communication** : En appuyant sur la touche **(S)** du premier combiné, la communication externe est transférée au combiné appelé.

13.3 La conférence

Une communication externe peut être branchée sur un autre correspondant interne dans le but de mener une conférence. Ainsi, deux combinés peuvent parler simultanément avec le correspondant externe.

1. Etablissez la liaison désirée avec le correspondant externe.
2. Appuyez pour cela sur la touche **(INT)** puis composez le numéro interne du deuxième combiné désiré.
3. Quand le deuxième correspondant interne a pris la communication, appuyez sur la touche **(#)** pendant 2 secondes et tous les trois correspondants sont branchés en conférence.











Remarque: Pendant une conférence, vous pouvez mettre le correspondant externe en attente en appuyant sur la touche **(INT)**. En appuyant de nouveau sur la touche **(#)** vous pouvez le rebrancher en conférence.

4. La conférence est terminée lorsqu'un des correspondants internes repose l'appareil.











14 Paramétrages de la base

A ce point du menu, vous trouverez la description des paramétrages concernant la base, comme p. ex. la mélodie d'appel, le volume de la sonnerie d'appel et le PIN du système.

14.1 Attribuer une mélodie d'appel à la base











1. Appuyez sur la touche .
2. Sélectionnez avec les touches  ou  le point du menu "paramétrages base".
3. Appuyez sur la touche . Plusieurs options apparaissent à l'écran.
4. Sélectionnez avec les touches  ou  l'option "sonnerie d'appel base".
5. Appuyez sur la touche . Un choix de plusieurs mélodies apparaît à l'écran.
6. Sélectionnez avec les touches  ou  la mélodie désirée.
7. Appuyez sur la touche . L'attribution est confirmée à l'écran.
8. En appuyant plusieurs fois sur la touche , le combiné retourne en mode de veille.

14.2 Régler le volume de la sonnerie d'appel de la base

1. Appuyez sur la touche .
2. Sélectionnez avec les touches  ou  le point du menu "paramétrages base".
3. Appuyez sur la touche . Plusieurs options apparaissent à l'écran.
4. Sélectionnez avec les touches  ou  l'option "volume base".
5. Appuyez sur la touche .
6. Sélectionnez avec les touches  ou  le volume désiré de la sonnerie d'appel.
7. Appuyez sur la touche . L'attribution est confirmée à l'écran.
8. En appuyant plusieurs fois sur la touche , le combiné retourne en mode de veille.

14.3 Activer/désactiver la sonnerie prioritaire d'un combiné











Vous pouvez ici choisir si un appel entrant doit sonner à tous les combinés déclarés ou s'il doit seulement sonner à un combiné bien précis.

1. Appuyez sur la touche .
2. Sélectionnez avec les touches  ou  le point du menu "paramétrages base".
3. Appuyez sur la touche . Plusieurs options apparaissent à l'écran.
4. Sélectionnez avec les touches  ou  l'option "combiné prioritaire".
5. Appuyez sur la touche . Plusieurs options apparaissent à l'écran.
6. Sélectionnez l'option "sélectionner combiné".
7. Appuyez sur la touche . Sélectionnez le combiné désiré.
8. Appuyez sur la touche . Plusieurs options apparaissent à l'écran. Si vous sélectionnez p. ex. l'option "sonnerie d'appel 4", le combiné sélectionné sonnera d'abord 4 fois avant de sonner aux autres combinés.
9. Sélectionnez d'abord une option puis appuyez sur la touche . L'attribution est confirmée à l'écran.
10. En appuyant sur la touche  vous retournez à chaque fois au niveau supérieur du menu.











Remarque: Si vous souhaitez que tous les combinés sonnent en même temps, sélectionnez à l'étape 6 l'option "tous les combinés", appuyez sur la touche  et quittez le paramétrage.

14.4 Régler les temps de flash



Vous pouvez sélectionner deux temps de flash à la fois, "flash 1" (100 ms) ou "flash 2" (300 ms). Pour un fonctionnement en installation à postes supplémentaires, vous nécessitez un temps de flash de 100 ms. Les services supplémentaires de Swisscom nécessitent p. ex. un temps de flash de 300 ms.

1. Appuyez sur la touche .
2. Sélectionnez avec les touches  ou  le point du menu "paramétrages base".
3. Appuyez sur la touche . Plusieurs options apparaissent à l'écran.
4. Sélectionnez avec les touches  ou  l'option "temps de flash".
5. Appuyez sur la touche . Un choix de deux temps de flash apparaît à l'écran.
6. Sélectionnez avec les touches  ou  le temps de flash "flash 1" (100 ms) ou "flash 2" (300 ms).
7. Appuyez sur la touche . L'attribution est confirmée à l'écran.
8. En appuyant sur la touche , vous retournez à chaque fois au niveau supérieur du menu.

14.5 Modifier le PIN du système

1. Appuyez sur la touche .
2. Sélectionnez avec les touches  ou  le point du menu "paramétrages base".
3. Appuyez sur la touche . Plusieurs options apparaissent à l'écran.
4. Sélectionnez avec les touches  ou  l'option "PIN du système".
5. Appuyez sur la touche . Le message "saisir ancien PIN" apparaît à l'écran.
6. Saisir l'ancien numéro PIN (réglage usine: 0000). Un "*" apparaît à la place du chiffre saisi à l'écran. Si vous avez mal saisi un chiffre, vous pouvez le supprimer avec la touche .
7. Après avoir saisi le numéro PIN complet, appuyez sur la touche . Le message "saisir nouveau PIN" apparaît.
8. Saisissez le nouveau numéro PIN (maximal 8 chiffres).
9. Appuyez sur la touche . Le message "confirmer nouveau PIN" apparaît.
10. Saisissez de nouveau le nouveau numéro PIN.

- Paramétrages de la base -











11. Appuyez sur la touche . L'attribution est confirmée à l'écran.
12. En appuyant sur la touche  vous retournez à chaque fois au niveau supérieur du menu.

Remarque: Si vous avez oublié le code PIN, vous pouvez l'obtenir de nouveau en appelant notre service en ligne. Service en ligne : voir au dos de notre mode d'emploi.













15 Réglage de l'horloge

Vous ne manquez aucun de vos rendez-vous grâce à l'horloge 24h et sa fonction réveil/alarme intégrée.















15.1 Réglage de la date et de l'heure

1. Appuyez sur la touche .
2. Sélectionnez avec les touches  ou  le point du menu "réglage horloge".
3. Appuyez sur la touche .
4. Sélectionnez avec les touches  ou  l'option "réglage heure et date".
5. Appuyez sur la touche . Saisissez la date par l'intermédiaire du pavé numérique.
6. Appuyez sur la touche . Saisissez l'heure par l'intermédiaire du pavé numérique.
7. Appuyez sur la touche . Les données sont enregistrées.
8. En appuyant sur la touche  vous retournez à chaque fois au niveau supérieur du menu.

15.2 Régler sonnerie réveil

1. Appuyez sur la touche .
2. Sélectionnez avec les touches  ou  le point du menu "réglage horloge".
3. Appuyez sur la touche .
4. Sélectionnez avec les touches  ou  l'option "réveil" à l'écran.
5. Appuyez sur la touche .
6. Sélectionnez avec les touches  ou  l'option "régler sonnerie du réveil" à l'écran.
7. Appuyez sur la touche .
8. Sélectionnez avec les touches  ou  la sonnerie du réveil désirée à l'écran.
9. Appuyez sur la touche . La sonnerie du réveil est enregistrée.

15.3 Saisir l'heure du réveil (activ / désac)

1. Appuyez sur la touche .
2. Sélectionnez avec les touches  ou  le point du menu "réglage horloge".
3. Appuyez sur la touche .
4. Sélectionnez avec les touches  ou  l'option "réveil" à l'écran.
5. Appuyez sur la touche .
6. Sélectionnez avec les touches  ou  l'option "activ / désac" à l'écran.
7. Appuyez sur la touche .
8. Sélectionnez avec les touches  ou  à l'écran si vous souhaitez être alarmé "une fois" ou "tous les jours" à une même heure.
9. Appuyez sur la touche . Saisissez l'heure désirée.
10. Appuyez sur la touche . Les données sont enregistrées.

Remarque: La fonction réveil est activée en saisissant l'heure du réveil. Le symbole  apparaît à côté de l'affichage de l'heure. Pour désactiver de nouveau la fonction réveil, sélectionnez à l'étape 8 l'option "désactivé".

11. En appuyant sur la touche  vous retournez à chaque fois au niveau supérieur du menu.

- **Elimination des perturbations** -

16 Elimination des perturbations

Si vous avez des problèmes avec votre téléphone, contrôlez tout d'abord les indications suivantes sur votre appareil. En ce qui concerne le droit à la garantie, veuillez vous adresser à votre revendeur. La durée de la garantie est de 2 ans.

Erreurs	Solutions
L'écran n'affiche rien	<ul style="list-style-type: none">- Le combiné n'est pas allumé.- La pile rechargeable est vide ou défectueuse.
Le numéro du correspondant n'est pas affiché même avec CLIP.	<ul style="list-style-type: none">- Le correspondant n'a pas autorisé la transmission du numéro auprès de l'exploitant du réseau.
Pas de connexion possible avec la base	<ul style="list-style-type: none">- Contrôlez si vous êtes bien identifié avec le bon numéro de code PIN sur la base.
Pas de communication téléphonique possible	<ul style="list-style-type: none">- Le câble du téléphone n'est pas correctement branché ou est soumis à des perturbations. N'utilisez que le câble téléphonique fourni avec l'appareil.- Testez avec un autre téléphone si votre raccordement téléphonique fonctionne.- Le bloc d'alimentation n'est pas branché ou il y a une panne totale de courant.- La pile rechargeable est vide ou défectueuse.- Vous vous êtes trop éloigné de la base.
La liaison est hachée, est coupée	<ul style="list-style-type: none">- Vous vous êtes trop éloigné de la base.- Mauvais lieu d'installation de la base.
Le voyant du contrôle de la charge n'est pas allumé	<ul style="list-style-type: none">- Placez le combiné correctement dans la base, nettoyez les surfaces de contact du combiné et de la base avec un chiffon sec et doux.
Après quelques heures, le symbole batterie clignote à l'écran	<ul style="list-style-type: none">- Posez le combiné sur la base et laissez-le pendant 14 heures. Si cela ne sert à rien, renouveler les piles rechargeables standard.
L'affichage de l'écran est sombre	<ul style="list-style-type: none">- Provient de l'ensoleillement direct, faire refroidir le combiné.
Aucun SMS ne peut être envoyé	<ul style="list-style-type: none">- Contrôlez les données du centre SMS. Demandez à votre exploitant du réseau.- Votre téléphone est branché à un autre poste.- Activez le service SMS auprès de votre exploitant du réseau.

17 Informations importantes

17.1 Données techniques

Caractéristique	Valeur
Standard	DECT-GAP
Alimentation en courant	Base 220/230 V, 50 Hz
Portée (à l'extérieur / à l'intérieur)	300 m / 50 m
Etat de veille	jusqu'à 85 h
Durée max. de communication	jusqu'à 10 h
Piles rechargeables standard	2 x AAA (1.2V / 750 mAh)
Numérotation	Numérotation à fréquence vocale (MFG)
Température ambiante autorisée	10°C à 30°C
Humidité atmosphérique relative autorisée	20% à 75%
Temps de flash	100 ms ou 300 ms

DECT: **D**igital **E**uropean **C**ordless **T**elephone = Standard pour téléphones sans fil.

GAP : **G**eneric **A**ccess **P**rofile = Standard pour l'action conjointe de combinés et de bases de fabricants différents.

17.2 Garantie

Les appareils Switel sont fabriqués et testés selon les procédés de production les plus modernes. Les matériaux choisis et la haute technologie assurent un fonctionnement parfait et une longue durée de vie. La garantie ne rentre pas en jeu si l'exploitant du réseau téléphonique ou une installation à postes supplémentaires éventuellement insérée est responsable du dysfonctionnement de l'appareil. La garantie ne s'applique pas aux piles rechargeables standard ou aux paquets de piles rechargeables utilisés dans le produit. La durée de garantie est de 24 mois à partir de la date de l'achat.

Pendant la période de la garantie, tous les défauts dus à des erreurs de matériel et de fabrication sont réparés gratuitement. La garantie expire en cas d'interventions de l'acheteur ou d'un tiers. Les dommages engendrés par une manipulation ou une utilisation inadéquates, par un mauvais emplacement ou rangement, par un raccordement ou une installation inadéquate ainsi que par une force majeure ou d'autres influences extérieures ne sont pas inclus dans la prestation de la garantie. En cas de réclamations, nous nous réservons le droit de réparer ou de remplacer les pièces défectueuses ou d'échanger l'appareil. Les pièces ou appareils échangés passent en notre propriété. Le droit de réclamer des dédommagements sont exclus sauf s'ils sont basés sur une préméditation ou une négligence grave du fabricant.

Si votre appareil devait cependant comporter un défaut pendant la période de la garantie, veuillez vous adresser exclusivement au magasin dans lequel vous avez acheté votre appareil, en présentant votre bon d'achat. Tous les droits de garantie basés sur ces dispositions ne peuvent être réclamés qu'auprès de votre revendeur. À l'échéance des deux ans après l'achat et la transmission de nos produits, les législations en matière de garantie ne sont plus applicables.

1	Indicazioni generali	65
1.1	Utilizzo conforme alle disposizioni	65
1.2	Caduta di tensione	65
1.3	Luogo di installazione	65
1.4	Alimentatore di rete	65
1.5	Batterie standard ricaricabili	65
1.6	Caricare l'unità portatile	65
1.7	Impianti telefonici interni	65
1.8	Resa di apparecchi usati	65
1.9	Avvertenza per apparecchiature mediche	65
1.10	Temperatura e ambiente circostante	66
1.11	Pulizia e cura	66
2	Caratteristiche funzionali	67
2.1	Telefono	67
3	Elementi di comando	68
3.1	Unità portatile	68
3.2	Stazione base / stazioni di carica	68
4	Messa in funzione	69
4.1	Indicazioni di sicurezza	69
4.2	Verificare il contenuto della confezione	69
4.3	Collegare la stazione base	69
4.4	Collegare la stazioni di carica	69
4.5	Inserire le batterie standard ricaricabili	69
4.6	Caricare le batterie standard ricaricabili	69
4.7	Selezione a toni - MFV	69
5	Esercizio	70
5.1	Il display	70
5.2	Navigare con i tasti	70
5.3	Condurre e concludere una telefonata	70
5.4	Ricevere una chiamata	70
5.5	Ricevere due chiamate esterne	70
5.6	Funzione vivavoce	71
5.7	Selezionare numeri di chiamata nella rubrica telefonica	71
5.8	Visualizzazione della durata di chiamata	71
5.9	Impostare il volume del ricevitore	71
5.10	Ripetizione di chiamata	71
5.11	Funzione di muting per unità portatile	71
5.12	Attivare/Disattivare l'unità portatile	71
5.13	Ricerca di unità portatile (tasto di paging)	71
5.14	Blocco tastiera	71
5.15	Avvertenza riguardo la distanza	71
6	Impianti telefonici interni / Servizi aggiuntivi	72
6.1	Tasto R in impianti telefonici interni	72
6.2	Tasto R e i servizi aggiuntivi della SWISSCOM	72
6.3	Pausa di selezione	72
7	Struttura di menu	73
8	La rubrica telefonica	75
8.1	Immettere numero di chiamata nella rubrica telefonica	75
8.2	Visualizzare dettagli della voce	75
8.3	Modificare voci memorizzate nella rubrica telefonica	75
8.4	Cancellare voce dalla rubrica telefonica	76
8.5	Cancellare tutte le voci dalla rubrica telefonica	76
8.6	Chiamata VIP (assegnazione di melodia)	76
9	Messaggi SMS	77
9.1	Centro assistenza	77
9.1.1	Immettere numero di invio/ricezione	77
9.2	Scrivere e inviare	78
9.3	Inviare messaggi SMS memorizzati	78

9.4	Leggere e rispondere	78
9.5	Suono messaggi On/Off	78
9.6	Impostare suono messaggi (suono Morse, discreto, polifonico)	79
9.7	Cancellare messaggio SMS	79
9.8	Cancellare tutti i messaggi SMS	79
9.9	Casella SMS	79
9.9.1	Aggiungere casella postale/utente	79
9.9.2	Visualizzare dati di casella postale/utente	80
9.9.3	Inviare messaggi SMS alla casella postale personale	80
9.9.4	Modificare dati di casella postale/utente	80
9.9.5	Cancellare casella postale/utente	80
10	Elenchi di chiamate	81
10.1	Visualizzazione del numero di chiamata (CLIP)	81
10.2	Chiamate ricevute	81
10.2.1	Visualizzare e chiamare	81
10.2.2	Cancellare la voce	81
10.2.3	Memorizzare voce nella rubrica telefonica	81
10.3	Chiamate mancate	82
10.3.1	Visualizzare e chiamare	82
10.3.2	Cancellare la voce	82
10.3.3	Memorizzare voce nella rubrica telefonica	82
10.4	Numeri selezionati (ripetizione di chiamata)	82
10.4.1	Visualizzare e chiamare	82
10.4.2	Cancellare la voce	82
10.4.3	Memorizzare voce nella rubrica telefonica	83
10.4.4	Cancellare un elenco chiamate	83
10.4.5	Cancellare tutti gli elenchi di chiamate	83
11	Unità portatile	84
11.1	Assegnare melodia di suoneria (chiamate interne ed esterne)	84
11.2	Impostare volume della suoneria chiamata	84
11.3	Immettere/modificare nome dell'unità portatile	84
11.4	Impostare la lingua	84
11.5	Impostare colore di menu	84
11.6	Attivare la ricezione automatica chiamate	85
11.7	Attivare codice di accesso (cifra per disponibilità linea)	85
12	Selezione e deselegione dell'unità portatile	86
12.1	Selezione unità portatile	86
12.2	Deselezione unità portatile	86
12.3	Selezione base	86
13	Maggior numero di unità portatili	87
13.1	Telefonate interne	87
13.2	Trasferimento di chiamate esterne ad un'altra unità portatile	87
13.3	Condurre chiamate a conferenza	87
14	Impostazioni di base	88
14.1	Assegnare una melodia di suoneria alla stazione base	88
14.2	Impostare volume di suoneria chiamata della stazione base	88
14.3	Attivare/Disattivare priorità di squillo di un'unità portatile	88
14.4	Impostare tempi flash	88
14.5	Modificare PIN di sistema	89
15	Impostazione orario	90
15.1	Impostare orario e data	90
15.2	Impostare suoneria di sveglia	90
15.3	Impostare orario di sveglia (ON/OFF)	90
16	Eliminazione di errori	91
17	Informazioni importanti	92
17.1	Dati tecnici	92
17.2	Garanzia	92

1 Indicazioni generali

Si prega di leggere attentamente le presenti istruzioni per l'uso.

Non aprire per nessuna ragione l'apparecchio autonomamente e svolgere riparazioni di propria iniziativa. In caso di reclami entro il periodo di garanzia si prega di rivolgersi al rivenditore autorizzato.

Con riserva di modifiche tecniche ed ottiche dell'articolo dovute a migliorie di sviluppo.

1.1 Utilizzo conforme alle disposizioni

Il presente telefono è stato sviluppato per l'esercizio con un allacciamento telefonico di accesso analogico (PSTN) entro i confini della Svizzera. Ciò nonostante, in particolare a causa di possibili differenze tra i vari gestori di reti di telecomunicazione, non è possibile assumere alcuna garanzia riguardo il perfetto funzionamento dell'apparecchio terminale per tutti gli allacciamenti di telecomunicazione. Collegare il cavo di allacciamento del telefono soltanto nell'apposita presa telefonica. Non sostituire il connettore del cavo di allacciamento.

1.2 Caduta di tensione

In caso di un'eventuale caduta di tensione non è possibile impiegare l'apparecchio per telefonare. Si consiglia pertanto di tenere a portata di mano in caso di emergenza un telefono con filo in grado di funzionare anche senza alimentazione elettrica esterna.

1.3 Luogo di installazione

Il luogo di installazione influenza decisamente il corretto funzionamento del telefono. Sul luogo di installazione è necessaria la presenza di una presa elettrica da 230 Volt.

Non posizionare la stazione base nelle dirette vicinanze di altri apparecchi elettronici come per es. forni a microonde o impianti HIFI, condizione che può invece causare un'influenza reciproca. Mantenere una distanza minima di un metro da altri apparecchi elettronici.

Posizionare la stazione base su una superficie piana e antiscivolo. In linea di massima, i piedini della stazione base non lasciano tracce sulla superficie di appoggio. A causa del numero crescente di vernici e superfici diverse non è comunque possibile escludere che i piedini dell'apparecchio possano lasciare delle tracce sulla superficie di appoggio.

1.4 Alimentatore di rete

Utilizzare esclusivamente l'alimentatore a spina SWITEL fornito in dotazione visto che altri alimentatori di rete potrebbero addirittura danneggiare il telefono. Pericolo di vita in caso di apertura dell'alimentatore a spina senza precedente scollegamento dalla rete elettrica.

1.5 Batterie standard ricaricabili

Non utilizzare batterie standard ricaricabili o set di accumulatori differenti da quanto descritto visto che altrimenti questi potrebbero causare un corto circuito. Utilizzare quindi in caso di sostituzione sempre batterie standard ricaricabili del tipo AAA 1,2V 750mAh.

Non gettare le batterie standard ricaricabili nel fuoco, né sommergerle in acqua.

Non procedere allo smaltimento di batterie standard ricaricabili usate o difettose assieme ai normali rifiuti domestici. Le durate di stand-by e di autonomia massima indicate si riferiscono all'impiego delle batterie standard ricaricabili fornite in dotazione in condizioni ottimali. Temperatura ambiente, ciclo di ricarica e altri fattori d'influsso esterni come per es. la sollecitazione di radiotrasmissione dell'ambiente circostante possono notevolmente ridurre la durata di impiego. La capacità di ricarica si riduce inoltre anche dal punto di vista tecnico nel corso della durata in vita oppure in seguito ad una conservazione in presenza di temperature particolarmente elevate o basse.



1.6 Caricare l'unità portatile

Il riscaldarsi dell'unità portatile durante il processo di carica è un fenomeno normale e non pericoloso. Evitare di caricare l'unità portatile con caricatori estranei, cosa che potrebbe causare dei danni.

1.7 Impianti telefonici interni

Il telefono è altresì collegabile ad un impianto telefonico interno. Il rivenditore specializzato è in grado di indicare se il telefono acquistato funzionerà senza alcun problema nel proprio impianto telefonico interno. A causa dell'ampia gamma di impianti telefonici interni differenti non è possibile assumere una garanzia riguardo il relativo funzionamento.

1.8 Resa di apparecchi usati

Volendo procedere allo smaltimento dell'apparecchio SWITEL, consegnare questo presso il punto di raccolta dell'azienda di smaltimento comunale (per es. punti di raccolta per materiali ricaricabili).

Il simbolo raffigurato qui a lato e riportato sul telefono indica che **non è consentito smaltire l'apparecchio usato assieme ai rifiuti domestici.**



In base a quanto indicato dalla legge sugli apparecchi elettrici ed elettronici, lo smaltimento dovrà avvenire nell'ambito della raccolta di rifiuti differenziata. Non smaltire l'apparecchio assieme ai rifiuti domestici rappresenta un importante contributo per la protezione dell'ambiente.

1.9 Avvertenza per apparecchiature mediche

Il telefono funziona con una potenza di trasmissione molto bassa. Questa potenza di trasmissione ridotta esclude, tenuto conto dell'attuale stato di ricerca e sviluppo tecnologico, un'esposizione a rischi di salute. Si è comunque dimostrato che telefoni portatili in funzione sono in grado di influenzare apparecchiature mediche. Evitare pertanto di tenere il telefono nelle vicinanze di apparecchiature mediche.

Un influsso su cardiostimolatori da parte di telefoni DECT non è stato finora osservato. Per effetto dell'ampio numero di cardiostimolatori impiegati non è comunque possibile escludere completamente un simile rischio.

Telefoni DECT possono causare un fastidioso ronzio in apparecchi acustici.

- **Indicazioni generali** -

1.10 Temperatura e ambiente circostante

Il telefono è stato progettato per l'uso in ambienti chiusi e protetti con una temperatura compresa tra 10 °C e 30 °C. Si consiglia di evitare l'uso della stazione base in ambienti esposti a umidità come bagno e locali di lavaggio. Evitare peraltro anche la vicinanza a fonti di calore come termosifoni e non esporre l'apparecchio alla diretta irradiazione solare.

Evitare l'uso dell'unità portatile in aree esposte al rischio di deflagrazione.

E' comunque necessario evitare un'esposizione a fumo, vibrazioni, sostanze chimiche, umidità, calore e raggi solari diretti al di sopra della norma.

1.11 Pulizia e cura

Pulire le superfici della custodia con un panno asciutto, morbido e antipilling. Non utilizzare mai detergenti o addirittura solventi aggressivi. Al di là di una pulizia di tanto in tanto della custodia esterna, non sono necessari ulteriori interventi di pulizia e cura. I piedini in gomma della stazione base non sono resistenti a qualsiasi detergente. Il costruttore non risponde pertanto di eventuali danni a mobili o simili.

2 Caratteristiche funzionali

2.1 Telefono

- Standard DECT/GAP digitale
- Fino a 10 ore di autonomia di conversazione - fino a 85 ore di stand-by
- Invio e ricezione di SMS
- Codifica della parola per elevata sicurezza
- Procedura di selezione a toni (MFV)
- Ottima visualizzazione grazie a display retroilluminato
- Semplice esercizio grazie a guida menu grafica
- Visualizzazione del numero di chiamata su display (CLIP)
- Elenco chiamate con 50 posizioni di memoria per chiamate ricevute/mancate
- Ripetizione di chiamata degli ultimi 20 numeri di chiamata
- Rubrica telefonica con 150 posizioni di memoria inclusi nomi
- Orologio 24 ore con funzione sveglia/allarme integrata nell'unità portatile
- Visualizzazione della durata di chiamata
- Espansione con altre unità portatili DECT con funzione GAP
- Esercizio multilink con fino a quattro ulteriori unità portatili
- Chiamate interne tra due unità portatili
- Conferenze tra due unità portatili ed un interlocutore esterno
- Inoltro di chiamate tra le unità portatili
- Melodie di suoneria differenti impostabili per unità portatile e stazione base
- Chiamata VIP (attribuzione di melodia)
- Idoneo per i servizi addizionali della Swisscom (Hook flash) - Idoneo all'integrazione in impianti telefonici interni
- Funzione di muting
- Blocco tastiera
- Funzione di vivavoce presso l'unità portatile

DECT: **D**igital **E**uropean **C**ordless **T**elephone = Standard per telefoni senza cavo.

GAP: **G**eneric **A**ccess **P**rofile = Standard per l'interazione di unità portatili con stazioni base di altri costruttori.

3 Elementi di comando

3.1 Unità portatile

1. Display grafico a colori
2. Numero selezionato / Volume + / Navigazione menu verso sopra
3. Rubrica telefonica
4. Concludere chiamata / On / Off
5. Chiamate mancate / Volume - / Navigazione menu verso sotto
6. Blocco tastiera
7. Chiamate interne e conferenze
8. Tasto di segnale R
9. Condurre chiamata / Funzione vivavoce
10. Tasto menu / Tasto di selezione

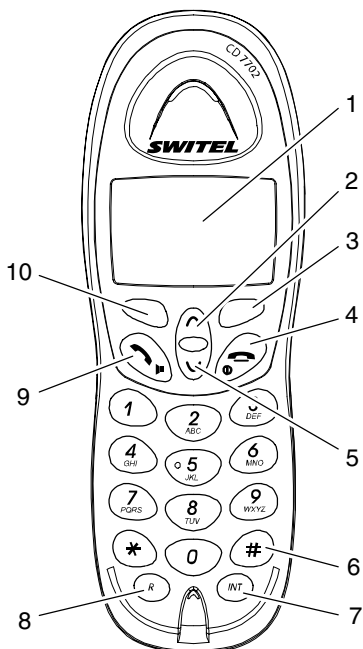

3.2 Stazione base / stazioni di carica

11. Tasto di ricerca unità portatile (tasto di paging)
12. LED Visualizzazione chiamata e rete
13. LED Spia di controllo dello stato di carica (stazione base)
14. LED Spia di controllo dello stato di carica (stazione di carica)

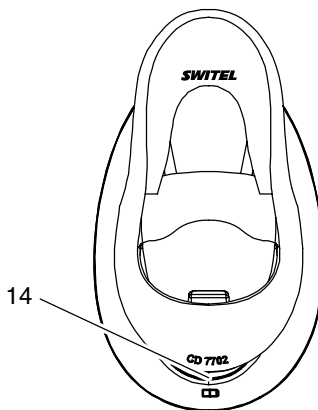
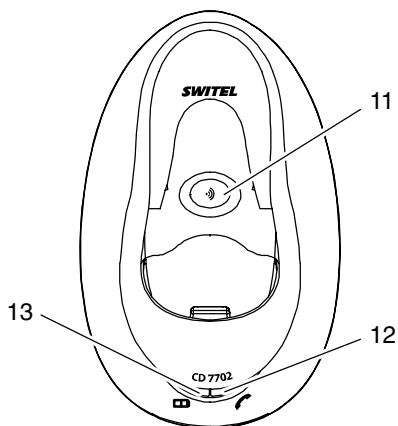

4 Messa in funzione

4.1 Indicazioni di sicurezza



Attenzione: Leggere assolutamente prima della messa in funzione le indicazioni generali riportate all'inizio delle presenti istruzioni per l'uso.

4.2 Verificare il contenuto della confezione

La confezione contiene:

una stazione base e un'unità portatile	un cavo di collegamento telefonico
due unità portatili	quattro batterie standard
due alimentatori di rete	un manuale di istruzioni per l'uso

4.3 Collegare la stazione base

Posizionare la stazione base in prossimità della presa di collegamento telefonico e di una presa elettrica. Utilizzare soltanto i componenti forniti in dotazione.

1. Inserire il connettore piccolo dell'alimentatore di rete nella rispettiva presa presente sul lato inferiore della stazione base.

Avvertenza: E' impossibile collegare il connettore in maniera errata, visto che connettori e prese sono costruiti con una protezione integrata che consente di prevenire un'eventuale inversione delle polarità. I connettori devono incastrarsi in maniera udibile nelle rispettive prese della stazione base.

2. Inserire il connettore piccolo del cavo di collegamento telefonico nella rispettiva presa presente sul lato inferiore della stazione base.
3. Condurre i due cavi presenti sulla parte inferiore della stazione base nella canalina per cavi appositamente prevista lungo il retro.
4. Inserire l'alimentatore di rete in una presa elettrica da 230 Volt installata in conformità alle disposizioni. L'alimentatore di rete della stazione base deve essere sempre collegato.
5. Collegare il cavo telefonico fornito con il jack telefonico.

4.4 Collegare la stazioni di carica

Posizionare la stazione di carica per la seconda unità portatile nelle vicinanze di una presa elettrica. Inserire l'alimentatore a spina in una presa elettrica da 230 Volt installata in conformità alle disposizioni.

4.5 Inserire le batterie standard ricaricabili

Al fine di inserire le batterie standard ricaricabili accluse all'interno dell'unità portatile, premere il coperchio del vano batterie sul bordo esterno e spingere contemporaneamente verso il basso. A questo punto inserire le batterie standard. Osservare la corretta polarità. Chiudere quindi il vano batterie.

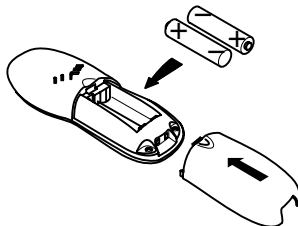

4.6 Caricare le batterie standard ricaricabili

Posizionare l'unità portatile con il display rivolto in avanti per una durata di minimo 14 ore sulla stazione base ovvero sulla stazione di carica. Presso la stazione base e la stazione di carica si illuminano le spie di controllo dello stato di carica. L'uso di batterie standard non ricaricate in maniera corretta può causare difetti o guasti al telefono.

Le batterie standard ricaricabili dell'apparecchio portatile sono in grado di garantire una durata di stand-by di max. 85 ore in presenza di temperatura ambiente. La durata di autonomia massima è di 10 ore.

Lo stato di carica attuale è visualizzato sul display:

Carico	A metà	Debole	Scarico

4.7 Selezione a toni - MFV

Questo telefono applica la procedura di selezione a toni - MFV (procedura di selezione multifrequenza). Tra i vantaggi di questa procedura di selezione moderna si ricordano tempi di collegamento brevi, possibilità di usufruire di funzioni a distanza per apparecchi come per es. segreteria telefonica oltre che uso delle altre funzioni ISDN.

5 Esercizio





5.1 Il display

Sul display sono visualizzate tutte le funzioni più importanti con i rispettivi simboli. Il display dispone di una retroilluminazione automatica che si attiva ogni volta che si preme un tasto per una durata di ca. 30 secondi.

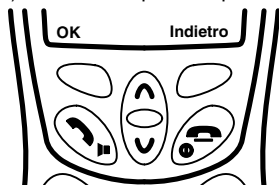
5.2 Navigare con i tasti



Tutte le funzioni sono accessibili attraverso un menu grafico di facile uso. Facendo attenzione ai testi di menu visualizzati sul display sarà possibile navigare tra le funzioni in maniera sicura ed intuitiva. Tutte le descrizioni riportate nelle presenti istruzioni per l'uso tengono conto dell'unità portatile in stato di riposo. Nello stato di riposo sul display appare l'immagine di una spiaggia assieme al nome dell'unità portatile (impostazione di default "Studio 1"). Lo stato di riposo è ripristinato premendo il tasto .





Tasto	Descrizione
	Tenuto conto della modalità selezionata, la funzione attuale è sempre visualizzata a sinistra sul display direttamente al di sopra del tasto. Per selezionare la funzione basta premere il tasto. In stato di riposo questo tasto apre il menu.
	Tenuto conto della modalità selezionata, la funzione attuale è sempre visualizzata a destra sul display direttamente al di sopra del tasto. Per selezionare la funzione basta premere il tasto. In stato di riposo questo tasto apre la rubrica telefonica.
	Premendo questo tasto all'interno del menu è possibile scorrere verso sopra.
	Premendo questo tasto all'interno del menu è possibile scorrere verso sotto.
	Premendo questo il tasto in una qualsiasi posizione all'interno del menu, la procedura viene interrotta e l'unità portatile ritorna in stato di riposo.

5.3 Condurre e concludere una telefonata

1. Immettere il numero di chiamata (max. 25 cifre).

Avvertenza: Premendo brevemente il tasto  si cancella la cifra immessa per ultima. Premendo a lungo il tasto  viene cancellato completamente l'intero numero di chiamata. L'apparecchio ritorna allo stato di riposo.

2. Premere il tasto  per procedere alla selezione del collegamento desiderato.

Avvertenza: E' altresì possibile premere prima il tasto  e immettere quindi il numero di chiamata. A differenza di quanto descritto sopra, nel corso di una simile chiamata non è possibile eseguire una correzione di singole cifre che compongono il numero di chiamata.



3. Per concludere la telefonata premere il tasto  o riporre l'unità portatile nella stazione base.

5.4 Ricevere una chiamata

Unità portatile e stazione base squillano avvisando una chiamata. Per ricevere la telefonata e instaurare il collegamento, estrarre l'unità portatile dalla stazione base. Il LED di visualizzazione di chiamata presso la stazione base lampeggia.

Avvertenza: Avendo disattivato la ricezione di chiamata automatica, il collegamento presso l'unità portatile è ripristinato premendo il tasto .

5.5 Ricevere due chiamate esterne



Dei segnali acustici indicano (avviso di chiamata) la ricezione di un'ulteriore chiamata durante lo svolgimento della prima telefonata. Sul display viene visualizzato il numero del secondo chiamante. Con la sequenza di tasti " (R)" "" è possibile passare da un interlocutore all'altro. Mentre è in corso la conversazione con un altro interlocutore, la chiamata è trattenuta.

Avvertenza: Per accedere alle funzioni dei servizi aggiuntivi della SWISSCOM è necessario impostare il tempo flash di 300 ms (vedi capitolo "14.4 Impostare tempi flash").





Attenzione: La visualizzazione del numero di chiamata e la funzione di avviso di chiamata sono dei servizi opzionali del rispettivo gestore della rete telefonica. Il telefono indicherà il numero di chiamata sul display solo se il gestore della rete telefonica offre questa funzione. Si consiglia di rivolgersi al gestore della propria rete telefonica per ricevere ulteriori informazioni a riguardo.

5.6 Funzione vivavoce

1. Premere nuovamente il tasto  durante lo svolgimento di una chiamata. A questo punto è possibile sentire il partner di chiamata attraverso l'altoparlante dell'unità portatile.
2. Premere nuovamente il tasto  per disattivare la funzione di vivavoce.

5.7 Selezionare numeri di chiamata nella rubrica telefonica

Dopo aver memorizzato alcuni numeri di chiamata all'interno della rubrica telefonica (vedi "Immettere numero di chiamata nella rubrica telefonica" capitolo 8.1), si ha modo di selezionare questi partner di chiamata in maniera semplice e rapida.

1. Premere il tasto . Sul display sono quindi visualizzate in ordine alfabetico le voci presenti nella rubrica telefonica.
2. Con il tasto  o  è possibile selezionare una delle voci dell'elenco telefonico.

Avvertenza: Per selezionare la voce direttamente, premere il tasto che corrisponde alla lettera iniziale della voce desiderata. Per selezionare per es. direttamente il nome "Peter", premere una volta il tasto .



3. Premere quindi il tasto  per selezionare automaticamente il numero di chiamata desiderato.

5.8 Visualizzazione della durata di chiamata

Mentre è in svolgimento una chiamata, dopo 15 secondi sul display viene visualizzata la durata della chiamata in minuti e secondi oltre che il numero di chiamata del rispettivo interlocutore.

5.9 Impostare il volume del ricevitore



Nel caso in cui il volume del ricevitore dovesse essere troppo basso o troppo alto, questo potrà essere impostato a rispetto delle proprie esigenze.

Mentre è in svolgimento una chiamata, premere il tasto  o  per impostare il volume scegliendo fra cinque livelli differenti.

5.10 Ripetizione di chiamata

Vedi "Numeri selezionati (ripetizione di chiamata)" capitolo 10.4.

5.11 Funzione di muting per unità portatile

Premendo il tasto  durante lo svolgimento di una chiamata telefonica è possibile attivare la funzione di muting per il microfono dell'unità portatile. Sul display viene visualizzato "Muting on". Ciò consente di parlare con una terza persona senza che il partner di chiamata possa sentire la conversazione. L'altoparlante presente nell'unità portatile rimane invece attivo, continuando a sentire il partner di chiamata in linea. Premendo nuovamente il tasto  la funzione di muting è infine disattivata.

5.12 Attivare/Disattivare l'unità portatile

Per attivare/disattivare l'unità portatile è necessario premere per 2 secondi il tasto . Il display si spegne ovvero si accende di nuovo.

5.13 Ricerca di unità portatile (tasto di paging)

Avendo perso d'occhio la propria unità portatile o non sapendo più dove è stata riposta, è possibile cercarla con l'aiuto della rispettiva stazione base.

1. Premere il tasto di paging  presente presso la stazione base. Tutte le unità portatili registrate presso la base cominciano ad emettere segnali acustici.
2. Per concludere la ricerca, premere sulla stazione base nuovamente il tasto di paging o un qualsiasi tasto sull'unità portatile.

5.14 Blocco tastiera



Se l'unità portatile è condotta spesso con sé, è possibile bloccarne la tastiera in modo da evitare di premere inavvertitamente dei tasti. L'attivazione del blocco tastiera consente ad ogni modo di ricevere telefonate in arrivo come di consueto.

5.14.1 Attivare il blocco tastiera

Premere sull'unità portatile il tasto  per tre secondi.

Sul display compare la visualizzazione "Blocco tastiera" assieme al simbolo .

5.14.2 Disattivare il blocco tastiera

Per disattivare la funzione di blocco tastiera, premere il tasto  e confermare premendo una seconda volta il tasto .

5.15 Avvertenza riguardo la distanza

La portata dell'unità portatile è di ca. 50 metri in ambienti chiusi e di ca. 300 metri all'aperto. In presenza di un buon collegamento con la stazione base, sul display appare il simbolo .

Avvertenza: Nel caso di un allontanamento eccessivo dalla stazione base, il simbolo  lampeggia facendo inoltre risuonare un segnale acustico di allarme. Avvicinarsi di nuovo alla stazione base altrimenti la chiamata in corso sarà interrotta.

6 Impianti telefonici interni / Servizi aggiuntionali

Il tasto **R** del telefono è disponibile in presenza di impianti telefonici interni oppure utilizzando i servizi aggiuntionali della Swisscom.

6.1 Tasto R in impianti telefonici interni

Avendo collegato il telefono ad un impianto telefonico interno, il tasto **R** consente di accedere a tutte le altre funzioni disponibili come per es. trasferimento di chiamata, funzione di richiamata automatica e così via. Un impianto telefonico interno richiede un tempo flash di 100 ms (per Impostazione vedi capitolo 14.4). Il rivenditore specializzato è in grado di indicare se il telefono acquistato funzionerà senza alcun problema nel proprio impianto telefonico interno.

6.2 Tasto R e i servizi aggiuntionali della SWISSCOM

Il telefono SWITEL supporta i più importanti servizi aggiuntionali della SWISSCOM (per es. funzioni di chiamata in attesa, avviso di chiamata, conferenza a tre). I servizi aggiuntionali della SWISSCOM operano con un tempo flash di 300 ms (per l'impostazione vedi capitolo 14.4). Si prega di rivolgersi direttamente alla SWISSCOM per l'abilitazione ai servizi aggiuntionali.

6.3 Pausa di selezione

In presenza di impianti telefonici interni è necessario selezionare un determinato numero (per es. "9" o "0") prima di ottenere un segnale di libero che indica la disponibilità della linea di collegamento di rete. Alcuni impianti telefonici interni di vecchia data richiedono un certo intervallo di tempo prima di trasmettere un segnale di libero. In particolare, proprio per questi impianti telefonici interni è possibile prevedere, una volta ottenuta la linea di collegamento di rete, una pausa automatica che consente di comporre il numero di chiamata desiderato senza dover necessariamente attendere il segnale di libero.

Premere tra la cifra da digitare per ottenere un segnale di libero ed il numero di chiamata da comporre una volta il tasto **^** per ca. 2 secondi. Sul display viene visualizzato "P". In seguito alla disponibilità della linea di collegamento di rete, il telefono aspetta 3 secondi prima di procedere con la selezione del numero che si desidera chiamare.

Avvertenza: La pausa è anche programmabile in sede di immissione dei numeri di chiamata nella rubrica telefonica.

- Struttura di menu -

7 **Struttura di menu**

Qui è riportata la struttura di menu del presente telefono. In stato di riposo la selezione dei menu disponibili è realizzata premendo il tasto . Per una maggiore facilità di visione generale, nei vari livelli non sono sempre visualizzate tutte le voci di menu.

SMS	Scrivi Messaggio	Opzioni	Invia a
			Salva
			Inserisci simbolo
			Nome Utilizzatore
	Messaggi Ricevuti	Leggi	Opzioni
			Rispondere
			Inoltre
			Cancella
	Messaggi Propri	Leggi	Opzioni
			Modifica
			Invia a
			Cancella
			Nome Utilizzatore
	Cancella messaggi	Messaggi Ricevuti	
		Messaggi Propri	
		Cancella Tutti	
	Impostazioni	Centro Servizi	Centro Servizio 1
			Centro Servizio 2
		NR. Terminale	
		Tono di Avviso	
		Nome Utilizzatore	
Lista chiamate	Ricevute	Opzioni	Cancella
			Visualizza Numero
			Salva in Rubrica
	Non Risposte	Opzioni	Cancella
			Visualizza Numero
			Salva in Rubrica
	Effettuate	Opzioni	Cancella
			Visualizza Numero
			Salva in Rubrica
	Cancella Lista	Ricevute	
		Non Risposte	
		Effettuate	
		Tutte le chiamate	

- Struttura di menu -

Imposta Portatile	Melodia	Chiamate esterne
		Chiamate interne
	Volume	
	Nome Portatile	
	Lingua	
	Colore Menu	
	Risposte Automatica	
	Codice di Accesso	

Imposta Base	Suoneria		
	Volume Suoneria		
	Priorità Portatile	Tutti i Portatili	
		Seleziona Portatile	Portatile 1-5
			Suoneria 2
			Suoneria 4
	Segnale flash		Suoneria 6
	Codice PIN (default: 0000)		

Orologio	Sveglia	Attiva/Disattiva	Singola
		Imposta Tono Sveglia	Quotidiana
		Tono di Sveglia 1-4	Disattiva
	Imposta Data e Ora	Data	Ora

Affiliazione	Registra Portatile	Base 1	Codice PIN (default: 0000)
		Base 2	
		Base 3	
		Base 4	
	Selezione base	Automatico	
		Base 1	
		Base 2	
		Base 3	
		Base 4	
	Disattiva portatile	Codice PIN (default: 0000)	





8 La rubrica telefonica

Lo stato di riposo si raggiunge premendo il tasto  nel menu relativo alla rubrica telefonica. La rubrica telefonica consente di memorizzare 150 numeri di chiamata assieme al nome del rispettivo interlocutore. Per l'immissione di un nome sono disponibili 16 caratteri. La lunghezza max. di un numero di chiamata è di 20 caratteri.



8.1 Immettere numero di chiamata nella rubrica telefonica

1. Premere il tasto . Sul display viene aperta la rubrica telefonica.

Avvertenza: Per compiere la memorizzazione della prima voce nella rubrica telefonica, procedere con passo 4.

2. Premere il tasto .
3. Selezionare con il tasto  o  nel display l'opzione "Inserire numero".
4. Premere il tasto . Sul display viene visualizzato il messaggio "Nome".
5. Immettere il rispettivo nome utilizzando i tasti numerici.





Avvertenza: Per l'immissione di testo vedi 8.1.1.

6. Premere il tasto . Sul display viene visualizzato il messaggio "Numero".
7. Immettere il numero di chiamata desiderato utilizzando i tasti numerici.
8. Premere il tasto . L'avvenuta immissione è confermata sul display.
9. Per procedere alla memorizzazione del numero di chiamata è sufficiente ripetere i punti da 3 a 9.
10. Premendo il tasto  l'unità portatile torna in stato di riposo.

8.1.1 Immissione di testo



L'immissione di testo viene eseguita utilizzando le lettere indicate sui tasti numerici del telefono. Premendo ripetutamente il relativo tasto, si ha modo di selezionare anche lettere e cifre.

Esempio: Per immettere per es. il nome "Peter", procedere come segue.

Premere: 1 x tasto , 2 x tasto , 1 x tasto , 2 x tasto , 3 x tasto 

- Per immettere uno spazio vuoto, premere una volta il tasto .
- Al fine di inserire la stessa lettera una seconda volta, premere sulla lettera e attendere fino a quando il cursore non si sarà spostato automaticamente sulla posizione successiva.



Avvertenza: Eventuali errori durante l'immissione sono cancellati con il tasto .

Per spostare il cursore a sinistra o a destra, premere il tasto  o .





8.1.2 Avvertenze riguardo la rubrica telefonica

- I numeri di chiamata dovranno essere immessi sempre con il rispettivo prefisso, cosa che consente di assegnare anche ai numeri di chiamate urbane una delle voci dell'elenco telefonico.
- Una volta raggiunta la capacità di memorizzazione di 150 numeri di chiamata, sul display appare un messaggio di avviso non appena si volesse procedere con un'ulteriore immissione. Per ottenere di nuovo spazio, cancellare delle voci dalla rubrica.



8.2 Visualizzare dettagli della voce

1. Premere il tasto . Sul display viene aperta la rubrica telefonica.
2. Selezionare con il tasto  o  nel display la voce desiderata.

Avvertenza: Per selezionare la voce direttamente, premere il tasto che corrisponde alla lettera iniziale della voce desiderata. Per selezionare per es. direttamente il nome "Peter", premere una volta il tasto .

3. Premere il tasto .
4. Selezionare con il tasto  o  nel display l'opzione "Visualizzare dettagli".
5. Premere il tasto . Sul display sono visualizzati il nome ed il numero di chiamata.
6. Premendo il tasto  è possibile fare ritorno al livello di menu precedente.

8.3 Modificare voci memorizzate nella rubrica telefonica

1. Premere il tasto . Sul display viene aperta la rubrica telefonica.
2. Selezionare con il tasto  o  nel display la voce desiderata.

Avvertenza: Per selezionare la voce direttamente, premere il tasto che corrisponde alla lettera iniziale della voce desiderata. Per selezionare per es. direttamente il nome "Peter", premere una volta il tasto .



3. Premere il tasto .
4. Selezionare con il tasto  o  nel display l'opzione "Modificare numero".
5. Premere il tasto .

Il nome è visualizzato sul display. Qualora necessario, procedere alla modifica del nome e proseguire con passo 6.



Avvertenza: Avvertenze relative all'immissione del nome sono riportate in 8.1.1.

6. Premere il tasto .
Il numero è visualizzato sul display. Qualora necessario, procedere alla modifica del numero e proseguire con passo 7.







- La rubrica telefonica -

7. Premere il tasto . La modifica è confermata sul display.
8. Premendo una volta il tasto  si ritorna alla rubrica telefonica per procedere all'immissione di altre voci.
9. Premendo il tasto  è possibile fare ritorno al livello di menu precedente.







8.4 Cancellare voce dalla rubrica telefonica

1. Premere il tasto . Sul display viene aperta la rubrica telefonica.
2. Selezionare con il tasto  o  nel display la voce desiderata.

Avvertenza: Per selezionare la voce direttamente, premere il tasto che corrisponde alla lettera iniziale della voce desiderata. Per selezionare per es. direttamente il nome "Peter", premere una volta il tasto .

3. Premere il tasto .
4. Selezionare con il tasto  o  nel display l'opzione "Cancellare numero".
5. Premere il tasto . Sul display viene visualizzata la richiesta di conferma per cancellare la voce selezionata.
6. Premere il tasto . L'avvenuta cancellazione è confermata sul display.
7. Premendo il tasto  l'unità portatile torna in stato di riposo.



8.5 Cancellare tutte le voci dalla rubrica telefonica

1. Premere il tasto . Sul display viene aperta la rubrica telefonica.
2. Premere il tasto .
3. Selezionare con il tasto  o  nel display l'opzione "Cancellare rubrica".
4. Premere il tasto . Sul display viene visualizzata la richiesta di conferma per cancellare tutte le chiamate.
5. Premere il tasto . L'avvenuta cancellazione è confermata sul display. Qualora desiderato, procedere all'immissione di nuove voci nella rubrica telefonica.
6. Premendo il tasto  l'unità portatile torna in stato di riposo.









8.6 Chiamata VIP (assegnazione di melodia)

Per determinate voci della rubrica telefonica considerati particolarmente importanti è possibile assegnare, in caso di chiamata, una specifica melodia di suoneria. In tal modo è possibile riconoscere il chiamante già dalla melodia di suoneria.



8.6.1 Assegnare melodia di suoneria

1. Premere il tasto . Sul display viene aperta la rubrica telefonica.
2. Selezionare con il tasto  o  nel display la voce desiderata.









Avvertenza: Per selezionare la voce direttamente, premere il tasto che corrisponde alla lettera iniziale della voce desiderata. Per selezionare per es. direttamente il nome "Peter", premere una volta il tasto .

3. Premere il tasto .
4. Selezionare con il tasto  o  nel display l'opzione "Suoneria di chiamata".
5. Premere il tasto . Sul display sono visualizzate differenti melodie da scegliere.
6. Selezionare con il tasto  o  nel display la suoneria desiderata.
7. Premere il tasto . L'avvenuta selezione è confermata sul display.
8. Premendo il tasto  è possibile fare ritorno al livello di menu precedente.

8.6.2 Disattivare l'assegnazione di una suoneria di chiamata

1. Premere il tasto . Sul display viene aperta la rubrica telefonica.
2. Selezionare con il tasto  o  nel display la voce desiderata.

Avvertenza: Per selezionare la voce direttamente, premere il tasto che corrisponde alla lettera iniziale della voce desiderata. Per selezionare per es. direttamente il nome "Peter", premere una volta il tasto .

3. Premere il tasto . Sul display sono visualizzate opzioni differenti.
4. Selezionare con il tasto  o  nel display l'opzione "Suoneria di chiamata".
5. Premere il tasto . Sul display sono visualizzate melodie di suoneria differenti da scegliere e l'opzione "Off".
6. Selezionare con il tasto  o  nel display l'opzione "Off".
7. Premere il tasto . L'avvenuta selezione è confermata sul display.
8. Premendo il tasto  è possibile fare ritorno al livello di menu precedente.

9 Messaggi SMS

Requisiti generali

La tanto diffusa comunicazione con messaggi brevi (SMS) è possibile anche da rete fissa. Con questo telefono è infatti possibile inviare e ricevere messaggi di testo (SMS). Al fine di inviare e ricevere i messaggi di testo SMS è comunque necessaria la presenza di alcuni requisiti.

- L'allacciamento telefonico deve disporre del servizio CLIP (Calling Line Identification Presentation). Si consiglia pertanto di informarsi presso il proprio gestore della rete telefonica affinché il servizio richiesto possa essere precedentemente attivato per l'allacciamento telefonico. L'abbonamento al servizio può essere soggetto a spese e dovrà essere eventualmente richiesto presso il proprio gestore della rete telefonica (per es. presso Swisscom chiamando al numero 0800800800).
- Verificare che allacciamento di rete fissa non sia bloccato per la selezione di numeri di chiamata che iniziano con 0190.

Avvertenza: In caso di collegamenti in call-by-call l'invio di un SMS al momento non è ancora possibile.

- Per l'utilizzo del servizio SMS è eventualmente necessario richiederne l'attivazione presso il proprio gestore della rete telefonica.
- L'invio di messaggi SMS è soggetto a costi supplementari.
- Nel caso in cui il ricevente non utilizzasse il servizio SMS su rete fissa o il rispettivo telefono non dovesse essere in grado di ricevere messaggi di testo, il messaggio SMS sarà automaticamente trasmesso come messaggio vocale e letto al telefono.
- L'addebito dei costi viene eseguito da parte del gestore della rete telefonica.

A causa dei costanti sviluppi può succedere che le indicazioni qui fornite siano già superate o che siano subentrati cambiamenti. Per informazioni aggiornate si prega di consultare le pagine del sito Internet o di chiamare al numero di assistenza clienti del proprio gestore della rete telefonica.

9.1 Centro assistenza

La distribuzione di tutti i messaggi SMS avviene attraverso un centro di assistenza. "Swisscom", "cablecom" così come anche altri gestori di rete telefonica offrono questo servizio. Il telefono SWITEL è predisposto per il funzionamento (invio e ricezione di messaggi SMS) nelle reti "Swisscom" e "cablecom".

Centro di assistenza della "Swisscom"

- Il numero del centro di assistenza della "Swisscom" è 0622 100 000.
- La funzione SMS della "Swisscom" è già stata abilitata. Non è più necessaria alcuna ulteriore registrazione.

















Centro di assistenza della "cablecom"

- Il numero del centro di assistenza della "cablecom" è 0435 375 370.
- La funzione SMS della "cablecom" è già stata abilitata. Non è più necessaria alcuna ulteriore registrazione.

L'unità portatile prevede la programmazione e memorizzazione di due numeri di chiamata SMS: un numero di chiamata è previsto per l'invio ed uno per la ricezione di messaggi SMS. Volendo invece utilizzare il servizio messo a disposizione da un altro offerente, sarà necessario programmare il rispettivo numero di chiamata/i rispettivi numeri di chiamata nell'unità portatile. Procedere a tale scopo come descritto in 9.1.1.







Avvertenza: Il processo di registrazione può variare a seconda dell'offerente scelto. Si prega di richiedere presso l'offerente scelto il numero di chiamata necessario e la procedura da seguire per l'abilitazione del servizio SMS.

9.1.1 Immettere numero di invio/ricezione







1. Premere il tasto .
2. Selezionare con il tasto  o  nel display la voce di menu "SMS".
3. Premere il tasto .
4. Selezionare con il tasto  o  nel display l'opzione "Impostazioni".
5. Premere il tasto .
6. Selezionare con il tasto  o  nel display l'opzione "Centro assistenza".
7. Premere il tasto .
8. Selezionare con il tasto  o  nel display l'opzione "CA di ricezione". Immettere quindi il numero di chiamata comunicato dall'offerente rispettivamente scelto.
9. Premere il tasto .
10. Selezionare con il tasto  o  nel display l'opzione "CA di invio". Immettere quindi il numero di chiamata comunicato dall'offerente rispettivamente scelto.
11. Premere il tasto .
12. Premendo il tasto  è possibile fare ritorno al livello di menu precedente.



9.2 Scrivere e inviare

Avvertenza: L'invio di un messaggio SMS non è possibile da un impianto telefonico interno. Per procedere all'invio di un messaggio SMS è necessario disattivare il "Codice di accesso" (vedi capitolo 11.7).





1. Premere il tasto .
2. Selezionare con il tasto  o  nel display la voce di menu "SMS".
3. Premere il tasto .
4. Selezionare con il tasto  o  nel display l'opzione "Scrivere messaggio".
5. Premere il tasto . Immettere quindi il testo utilizzando i tasti numerici. E' possibile immettere fino a 160 segni.

Avvertenza: Per l'immissione di testo vedi 8.1.1.

Avvertenza: Per inserire un simbolo, premere il tasto  durante l'immissione del testo. Selezionare con il tasto  o  nel display l'opzione "Inserire simbolo". Premere il tasto . Selezionare quindi con il tasto  o  il simbolo desiderato. Premere il tasto . Il display ritorna nuovamente all'immissione di testo. Completare il testo per il proprio messaggio











6. Premere il tasto .
7. Selezionare con il tasto  o  nel display l'opzione "Inviare a".

Avvertenza: Nel caso in cui si desiderasse inviare il messaggio SMS più tardi, selezionare in sede di passo 7 l'opzione "Salvare". Il messaggio SMS viene così infatti salvato nella lista "Uscita".

8. Premere il tasto .
9. Immettere ora il numero di chiamata del destinatario del messaggio.
Se il ricevente è memorizzato all'interno della rubrica telefonica, premere il tasto . Selezionare con il tasto  o  il destinatario del messaggio desiderato e premere quindi il tasto . Procedere con passo 10.

10. Premere il tasto . L'avvenuto invio è confermato sul display.



9.3 Inviare messaggi SMS memorizzati







1. Premere due volte il tasto .
2. Selezionare con il tasto  o  nel display l'opzione "Uscita".
3. Premere il tasto .
4. Selezionare con il tasto  o  nel display il messaggio SMS desiderato.
5. Premere due volte il tasto .
6. Selezionare con il tasto  o  nel display l'opzione "Inviare a".
7. Premere il tasto .
8. Immettere il numero di chiamata del destinatario del messaggio e premere infine il tasto .

9.4 Leggere e rispondere









Non appena è stato ricevuto un messaggio SMS, viene emesso un segnale acustico ed il display indica l'arrivo di un nuovo messaggio.

1. Premere il tasto . Sul display si apre la lista di messaggi ricevuti. Messaggi SMS non ancora letti sono contrassegnati da una stella.

Avvertenza: Volendo rispondere ad un messaggio SMS già letto, premere due volte il tasto , selezionare con il tasto  o  nel display l'opzione "Arrivo" e confermare premendo il tasto . Procedere con passo 2.





2. Selezionare con il tasto  o  nel display il messaggio SMS desiderato.
3. Premere il tasto . Sul display viene visualizzato il messaggio SMS.
4. Premere il tasto .
5. Selezionare con il tasto  o  nel display l'opzione "Rispondere". Selezionare l'opzione "Inoltrare", per inoltrare il messaggio SMS. Per inoltrare il messaggio SMS procedere con passo 8.
6. Premere il tasto . Immettere quindi il testo utilizzando i tasti numerici. E' possibile immettere fino a 160 segni.

Avvertenza: Per l'immissione di testo vedi 8.1.1.

















7. Premere il tasto .
8. Selezionare con il tasto  o  nel display l'opzione "Inviare a".
9. Premere il tasto .
10. Immettere ora il numero di chiamata del destinatario del messaggio. Se il ricevente è memorizzato all'interno della rubrica telefonica, premere il tasto . Selezionare con il tasto  o  il destinatario del messaggio desiderato e premere quindi il tasto .
11. Premere il tasto . L'avvenuto invio è confermato sul display.

9.5 Suono messaggi On/Off

1. Premere il tasto .
2. Selezionare con il tasto  o  nel display la voce di menu "SMS".
3. Premere il tasto .
4. Selezionare con il tasto  o  nel display l'opzione "Impostazioni".
5. Premere il tasto .
6. Selezionare con il tasto  o  nel display l'opzione "Suono messaggi".















7. Premere il tasto .
8. Selezionare con il tasto  o  nel display in base alle proprie esigenze l'opzione "On" oppure "Off".
9. Premere il tasto .
10. Premendo il tasto  è possibile fare ritorno al livello di menu precedente.

9.6 Impostare suono messaggi (suono Morse, discreto, polifonico)

1. Premere il tasto .
2. Selezionare con il tasto  o  nel display la voce di menu "SMS".
3. Premere il tasto .
4. Selezionare con il tasto  o  nel display l'opzione "Impostazioni".
5. Premere il tasto .
6. Selezionare con il tasto  o  nel display l'opzione "Suono messaggi".
7. Premere il tasto .
8. Selezionare con il tasto  o  nel display l'opzione "Impostare suono di avviso".
9. Premere il tasto .
10. Selezionare con il tasto  o  nel display la tonalità desiderata.
11. Premere il tasto . La modifica è confermata sul display.







9.7 Cancellare messaggio SMS



E' possibile cancellare singoli messaggi SMS dalle cartelle "Arrivo" e "Uscita".



1. Premere il tasto .
2. Selezionare con il tasto  o  nel display la voce di menu "SMS".
3. Premere il tasto .
4. Selezionare con il tasto  o  nel display l'opzione "Arrivo" o "Uscita".
5. Premere il tasto .
6. Selezionare con il tasto  o  nel display il messaggio SMS desiderato.
7. Premere il tasto .
8. Premere il tasto  e selezionare l'opzione "Cancellare".
9. Premere il tasto .
10. Premere il tasto  per confermare la procedura di cancellazione.
11. Premendo il tasto  è possibile fare ritorno al livello di menu precedente.

9.8 Cancellare tutti i messaggi SMS

La funzione consente di cancellare completamente tutti i messaggi SMS presenti nelle liste di "Arrivo" e "Uscita".

1. Premere il tasto .
2. Selezionare con il tasto  o  nel display la voce di menu "SMS".
3. Premere il tasto .
4. Selezionare con il tasto  o  nel display l'opzione "Cancellare messaggio".
5. Premere il tasto .
6. Selezionare con il tasto  o  nel display l'opzione "Tutti i messaggi".

Avvertenza: Per cancellare solo i messaggi SMS presenti nelle cartelle "Arrivo" ovvero "Uscita", selezionare con il tasto  o  nel display la rispettiva opzione.

7. Premere il tasto . Sul display viene visualizzata una richiesta di conferma.
8. Premere il tasto . L'avvenuta cancellazione è confermata sul display.
9. Premendo il tasto  è possibile fare ritorno al livello di menu precedente.















9.9 Casella SMS



Oltre alla casella postale generale già prevista è possibile creare e proteggere con password altre quattro caselle postali. Ogni singola casella postale è contrassegnata da un nome utente e da un ID specifico per la casella (cifra di teleselezione). Questa funzione consente di ricevere messaggi SMS destinati esclusivamente ad un unico e specifico utente.

Avvertenza: Caselle SMS possono essere utilizzate solo se il gestore della rete telefonica supporta questa funzione. Si prega di rivolgersi al proprio gestore della rete telefonica per ottenere le istruzioni di configurazione necessarie alla creazione delle caselle postali.

9.9.1 Aggiungere casella postale/utente

Avvertenza: E' possibile aggiungere fino a quattro utenti.

1. Premere il tasto .
2. Selezionare con il tasto  o  nel display la voce di menu "SMS".
3. Premere il tasto .
4. Selezionare con il tasto  o  nel display l'opzione "Impostazioni".
5. Premere il tasto .
6. Selezionare con il tasto  o  nel display l'opzione "Utente".
7. Premere il tasto .
8. Selezionare con il tasto  o  nel display l'opzione "Aggiungere utente".
9. Premere il tasto . Immettere quindi il nome dell'utente utilizzando i tasti numerici.
10. Premere il tasto . Immettere una password composta da fino a cinque segni utilizzando i tasti numerici.

11. Premere il tasto . Immettere la password una seconda volta utilizzando i tasti numerici.
12. Premere il tasto . La casella postale è stata creata.
13. Premendo il tasto  è possibile fare ritorno al livello di menu precedente.

9.9.2 Visualizzare dati di casella postale/utente

Avvertenza: Per configurare le caselle postali nella rete telefonica selezionata, è necessario il codice ID della casella postale (cifra di teleselezione). Il codice ID della casella postale generale è "0". Al momento della registrazione di altri utenti, alla casella postale viene assegnato automaticamente il codice ID libero più basso (1-4).

1. Premere il tasto .
2. Selezionare con il tasto  o  nel display la voce di menu "SMS".
3. Premere il tasto .
4. Selezionare con il tasto  o  nel display l'opzione "Impostazioni".
5. Premere il tasto .
6. Selezionare con il tasto  o  nel display l'opzione "Utente".
7. Premere il tasto .
8. Selezionare con il tasto  o  nel display l'utente desiderato.
9. Premere il tasto . Immettere la rispettiva password.
10. Premere il tasto .
11. Selezionare con il tasto  o  nel display l'opzione "Numero apparecchio".
12. Premere il tasto . Viene visualizzato il numero dell'apparecchio.

Avvertenza: Il numero apparecchio indicato al passo 12 corrisponde così al codice ID per la casella postale richiesto dal gestore della rete telefonica.

13. Premendo il tasto  è possibile fare ritorno al livello di menu precedente.

9.9.3 Inviare messaggi SMS alla casella postale personale



















Avvertenza: Caselle SMS possono essere utilizzate solo se il gestore della rete telefonica supporta questa funzione. Si prega di rivolgersi al proprio gestore della rete telefonica per ottenere le istruzioni di configurazione necessarie alla creazione delle caselle postali.

Per inviare un SMS alla casella postale personale, il mittente del messaggio deve conoscere il codice ID della rispettiva casella postale da aggiungere al numero telefonico selezionato.



















E' inoltre possibile inviare al partner di SMS un messaggio SMS proveniente dalla propria casella postale personale.

Questo messaggio SMS consente al partner di SMS di memorizzare nella propria rubrica telefonica il numero di chiamata di SMS assieme al codice ID relativo alla casella postale. Se l'ID della casella postale non è valido, il messaggio SMS non sarà consegnato.

9.9.4 Modificare dati di casella postale/utente

1. Premere il tasto .
2. Selezionare con il tasto  o  nel display la voce di menu "SMS".
3. Premere il tasto .
4. Selezionare con il tasto  o  nel display l'opzione "Impostazioni".
5. Premere il tasto .
6. Selezionare con il tasto  o  nel display l'opzione "Utente".
7. Premere il tasto .
8. Selezionare con il tasto  o  nel display l'utente desiderato.
9. Premere il tasto . Immettere la rispettiva password.
10. Premere il tasto .
11. Selezionare con il tasto  o  una delle opzioni che si desidera modificare.
12. Premere il tasto . Eseguire la modifica dell'impostazione.
13. Premere il tasto . A questo punto è possibile compiere ulteriori modifiche.
14. Premendo il tasto  è possibile fare ritorno al livello di menu precedente.

9.9.5 Cancellare casella postale/utente

1. Premere il tasto .
2. Selezionare con il tasto  o  nel display la voce di menu "SMS".
3. Premere il tasto .
4. Selezionare con il tasto  o  nel display l'opzione "Impostazioni".
5. Premere il tasto .
6. Selezionare con il tasto  o  nel display l'opzione "Utente".
7. Premere il tasto .
8. Selezionare con il tasto  o  nel display l'opzione "Cancellare utente".
9. Premere il tasto .
10. Selezionare con il tasto  o  l'utente desiderato.
11. Premere il tasto . Immettere il PIN di sistema (impostazione di default = 0000).
12. Premere il tasto .
13. Premendo il tasto  è possibile fare ritorno al livello di menu precedente.

10 Elenchi di chiamate

10.1 Visualizzazione del numero di chiamata (CLIP)

Grazie alla funzione di visualizzazione del numero di chiamata è possibile individuare il chiamante in caso di telefonata in arrivo. A condizione che la linea telefonica offra questa funzione, sul display LCD sarà visualizzato il numero del chiamante non appena il telefono squilla. Nel caso di blocco da parte del chiamante della trasmissione del proprio numero telefonico, il numero di chiamata non sarà visualizzato. Se il numero di chiamata è stato precedentemente memorizzato nella rubrica telefonica, al posto del numero di chiamata viene visualizzato il nome.











Gli elenchi "Chiamate ricevute" e "Chiamate mancate" hanno uno spazio di memoria comune in grado di visualizzare fino a 50 numeri di chiamata. Se ad es. nell'elenco "Chiamate ricevute" si trovano memorizzati 32 numeri di chiamata, nell'elenco "Chiamate mancate" saranno disponibili altre 18 posizioni di memoria. Non appena le 50 posizioni di memoria risultano occupate, si procede alla cancellazione della voce più vecchia.

Avvertenza: La visualizzazione del numero di chiamata è un servizio opzionale offerto dal gestore della propria rete telefonica. Il telefono indicherà il numero di chiamata sul display solo se il gestore della rete telefonica offre questa funzione. La visualizzazione di data e ora è un'informazione che non viene trasmessa da tutti i gestori di rete telefonica. Si consiglia di rivolgersi al gestore della propria rete telefonica per ricevere ulteriori informazioni a riguardo. Anche alcuni impianti telefonici interni non supportano la trasmissione del numero di chiamata o anche di data e orario.













10.2 Chiamate ricevute



Nell'elenco "Chiamate ricevute" sono memorizzate tutte le chiamate a cui si è risposto.



10.2.1 Visualizzare e chiamare

1. Premere il tasto .
2. Selezionare con il tasto  o  nel display la voce di menu "Elenchi di chiamate".
3. Premere il tasto .
4. Selezionare con il tasto  o  nel display l'opzione "Chiamate ricevute".
5. Premere il tasto . Sul display sono visualizzate le chiamate ricevute.
6. Volendo chiamare il numero di una telefonata ricevuta, selezionare con il tasto  o  nel display il numero dell'interlocutore desiderato.
7. Premere il tasto . Il collegamento è instaurato.

10.2.2 Cancellare la voce















1. Premere il tasto .
2. Selezionare con il tasto  o  nel display la voce di menu "Elenchi di chiamate".
3. Premere il tasto .
4. Selezionare con il tasto  o  nel display l'opzione "Chiamate ricevute".
5. Premere il tasto . Sul display sono visualizzate le chiamate ricevute.
6. Selezionare con il tasto  o  nel display il numero desiderato.
7. Premere il tasto .
8. Selezionare con il tasto  o  nel display l'opzione "Cancellare".

Avvertenza: Oltre all'opzione "Cancellare" è possibile altresì scegliere l'opzione "Visualizzare dettagli". Avendo selezionato la voce "Visualizzare dettagli", sul display è possibile visualizzare nome e numero di chiamata premendo il tasto . Premendo il tasto  si torna indietro all'elenco "Chiamate ricevute".

9. Premere il tasto . L'avvenuta cancellazione è confermata sul display.
10. L'unità portatile torna indietro all'elenco "Chiamate ricevute".
11. Per cancellare ulteriori voci è sufficiente ripetere i passi da 6 a 9.
12. Premendo il tasto  è possibile fare ritorno al livello di menu precedente.

10.2.3 Memorizzare voce nella rubrica telefonica

L'apparecchio consente di memorizzare un numero di chiamata visualizzato nell'elenco "Chiamate ricevute" direttamente nella rubrica telefonica.







1. Premere il tasto .
2. Selezionare con il tasto  o  nel display la voce di menu "Elenchi di chiamate".
3. Premere il tasto .
4. Selezionare con il tasto  o  nel display l'opzione "Chiamate ricevute".
5. Premere il tasto . Sul display sono visualizzate le chiamate ricevute.
6. Selezionare con il tasto  o  nel display il numero desiderato.
7. Premere il tasto .
8. Selezionare con il tasto  o  nel display l'opzione "Inserire numero".
9. Premere il tasto .
10. Immettere il rispettivo nome utilizzando i tasti numerici.
11. Premere due volte il tasto . L'avvenuta immissione è confermata sul display.
12. Premendo il tasto  è possibile fare ritorno al livello di menu precedente.

10.3 Chiamate mancate



Nell'elenco "Chiamate mancate" sono memorizzate tutte le chiamate mancate, funzione che consente di non perdere nessuna telefonata anche in caso di assenza. Sono tre le possibilità per accedere all'elenco "Chiamate mancate":

- Premendo il tasto , oppure
- il display indica che sono state memorizzate delle chiamate mancate, premendo il tasto , oppure
- vedi quanto descritto in 10.3.1.







10.3.1 Visualizzare e chiamare



1. Premere il tasto .
2. Selezionare con il tasto  o  nel display la voce di menu "Elenchi di chiamate".
3. Premere il tasto .
4. Selezionare con il tasto  o  nel display l'opzione "Chiamate mancate".
5. Premere il tasto . Sul display sono visualizzate le chiamate mancate.



Avvertenza: Le voci di nuovo arrivo sono contrassegnate con una stella.

6. Volendo chiamare il numero di una telefonata mancata, selezionare con il tasto  o  nel display il numero dell'interlocutore desiderato.
7. Premere il tasto . Il collegamento è instaurato.

10.3.2 Cancellare la voce









1. Premere il tasto . Sul display sono visualizzate le chiamate mancate.
2. Selezionare con il tasto  o  nel display il numero desiderato.
3. Premere il tasto .
4. Selezionare con il tasto  o  nel display l'opzione "Cancellare".

Avvertenza: Oltre all'opzione "Cancellare" è possibile altresì scegliere l'opzione "Visualizzare dettagli". Avendo selezionato la voce "Visualizzare dettagli", sul display è possibile visualizzare nome e numero di chiamata premendo il tasto . Premendo il tasto  si torna indietro all'elenco "Chiamate mancate".

5. Premere il tasto . L'avvenuta cancellazione è confermata sul display.
6. Premendo il tasto  l'unità portatile torna in stato di riposo.

10.3.3 Memorizzare voce nella rubrica telefonica

L'apparecchio consente di memorizzare un numero di chiamata visualizzato nell'elenco "Chiamate mancate" direttamente nella rubrica telefonica.

1. Premere il tasto . Sul display sono visualizzate le chiamate mancate.
2. Selezionare con il tasto  o  nel display il numero desiderato.
3. Premere il tasto .
4. Selezionare con il tasto  o  nel display l'opzione "Inserire numero".
5. Premere il tasto . Immettere quindi il nome utilizzando i rispettivi tasti.
6. Premere due volte il tasto . L'avvenuta immissione è confermata sul display.
7. Premendo il tasto  l'unità portatile torna in stato di riposo.

Avvertenza: Non appena al numero di chiamata corrisponde un nome memorizzato nella rubrica telefonica, nell'elenco chiamate non sarà più visualizzato il numero di chiamata bensì il nome immesso.



10.4 Numeri selezionati (ripetizione di chiamata)

Nell'elenco "Numeri selezionati" sono memorizzati i numeri di chiamata selezionati.







10.4.1 Visualizzare e chiamare



1. Premere il tasto . Sul display sono visualizzati i numeri selezionati.



Avvertenza: Se un numero è memorizzato nella rubrica telefonica, viene visualizzato anche il nome assegnato.

2. Volendo chiamare un numero già selezionato in precedenza, selezionare con il tasto  o  nel display il numero dell'interlocutore desiderato.
3. Premere il tasto . Il collegamento è instaurato.

10.4.2 Cancellare la voce

1. Premere il tasto . Sul display sono visualizzati i numeri selezionati.
2. Selezionare con il tasto  o  nel display il numero desiderato.
3. Premere il tasto .
4. Selezionare con il tasto  o  nel display l'opzione "Cancellare".









Avvertenza: Oltre all'opzione "Cancellare" è possibile altresì scegliere l'opzione "Visualizzare dettagli". Avendo selezionato la voce "Visualizzare dettagli", sul display è possibile visualizzare nome e numero di chiamata premendo il tasto . Premendo il tasto  si torna indietro all'elenco "Chiamate mancate".

5. Premere il tasto . L'avvenuta cancellazione è confermata sul display.
6. Premendo il tasto  è possibile fare ritorno al livello di menu precedente.

- Elenchi di chiamata -

10.4.3 Memorizzare voce nella rubrica telefonica

L'apparecchio consente di memorizzare un numero di chiamata visualizzato nell'elenco "Numeri selezionati" direttamente nella rubrica telefonica.











1. Premere il tasto . Sul display sono visualizzati i numeri selezionati.
2. Selezionare con il tasto  o  nel display il numero desiderato.
3. Premere il tasto .
4. Selezionare con il tasto  o  nel display l'opzione "Inserire numero".
5. Premere il tasto . Immettere quindi il nome utilizzando i rispettivi tasti.
6. Premere due volte il tasto . L'avvenuta immissione è confermata sul display.
7. Premendo il tasto  è possibile fare ritorno al livello di menu precedente.

Avvertenza: Non appena al numero di chiamata corrisponde un nome memorizzato nella rubrica telefonica, nell'elenco chiamate non sarà più visualizzato il numero di chiamata bensì il nome immesso.



10.4.4 Cancellare un elenco chiamate

E' possibile cancellare completamente tutte le voci di un elenco chiamate ("Chiamate ricevute", "Chiamate mancate" e "Numeri selezionati") a scelta.

Avvertenza: La sequenza da seguire è descritta nell'esempio dell'elenco "Chiamate ricevute". I passi da svolgere sono uguali anche per quanto riguarda gli elenchi "Chiamate mancate" e "Numeri selezionati".











1. Premere il tasto .
2. Selezionare con il tasto  o  nel display la voce di menu "Elenchi di chiamate".
3. Premere il tasto .
4. Selezionare con il tasto  o  nel display l'opzione "Cancellare elenco chiamate".
5. Premere il tasto .
6. Selezionare con il tasto  o  nel display l'opzione "Chiamate ricevute".
7. Premere il tasto .
8. Premere il tasto . Sul display viene visualizzata la richiesta di conferma per cancellare l'elenco chiamate.

Avvertenza: Nel passo successivo tutte le voci presenti nell'elenco "Chiamate ricevute" sono irrevocabilmente cancellate. Premendo il tasto  è possibile interrompere il processo di cancellazione.



9. Premere il tasto . L'avvenuta cancellazione è confermata sul display.
10. Premendo il tasto  è possibile fare ritorno al livello di menu precedente.

10.4.5 Cancellare tutti gli elenchi di chiamate

E' possibile cancellare completamente tutte le voci presenti negli elenchi di chiamate ("Chiamate ricevute", "Chiamate mancate" e "Numeri selezionati").

1. Premere il tasto .
2. Selezionare con il tasto  o  nel display la voce di menu "Elenchi di chiamate".
3. Premere il tasto .
4. Selezionare con il tasto  o  nel display l'opzione "Cancellare elenco chiamate".
5. Premere il tasto .
6. Selezionare con il tasto  o  nel display l'opzione "Tutte le chiamate".
7. Premere il tasto . Sul display viene visualizzata la richiesta di conferma per cancellare tutte le chiamate.

Avvertenza: Nel passo successivo tutte le voci presenti negli elenchi di chiamate ("Chiamate ricevute", "Chiamate mancate" e "Numeri selezionati") sono cancellate irrevocabilmente. Premendo il tasto  è possibile interrompere il processo di cancellazione.















8. Premere il tasto . L'avvenuta cancellazione è confermata sul display.
9. Premendo il tasto  è possibile fare ritorno al livello di menu precedente.

11 Unità portatile









E' possibile compiere impostazioni differenti all'unità portatile in base alle proprie preferenze.

11.1 Assegnare melodia di suoneria (chiamate interne ed esterne)



E' possibile assegnare melodie di suoneria differenti per chiamate interne ed esterne. La rispettiva impostazione è descritta all'esempio di chiamate esterne.

1. Premere il tasto .
2. Selezionare con il tasto  o  nel display la voce di menu "Unità portatile".
3. Premere il tasto . Sul display sono visualizzate opzioni differenti.
4. Selezionare con i tasti  o  l'opzione "Suoneria di chiamata".
5. Premere il tasto .
6. Selezionare con il tasto  o  nel display l'opzione "Chiamate esterne".
7. Premere il tasto . Sul display sono visualizzate differenti melodie a scelta.
8. Selezionare quindi con il tasto  o  la melodia desiderata.
9. Premere il tasto . L'avvenuta selezione è confermata sul display.
10. Premendo il tasto  è possibile fare ritorno al livello di menu precedente.













11.2 Impostare volume della suoneria chiamata

1. Premere il tasto .
2. Selezionare con il tasto  o  nel display la voce di menu "Unità portatile".
3. Premere il tasto . Sul display sono visualizzate opzioni differenti.
4. Selezionare con i tasti  o  l'opzione "Volume della suoneria chiamata".
5. Premere il tasto .
6. Selezionare quindi con il tasto  o  il volume della suoneria chiamata desiderata.

Avvertenza: Avendo selezionato l'opzione "Volume Off", sul display appare il simbolo .











7. Premere il tasto . L'avvenuta selezione è confermata sul display.
8. Premendo il tasto  è possibile fare ritorno al livello di menu precedente.

11.3 Immettere/modificare nome dell'unità portatile

1. Premere il tasto .
2. Selezionare con il tasto  o  nel display la voce di menu "Unità portatile".
3. Premere il tasto . Sul display sono visualizzate opzioni differenti.
4. Selezionare con il tasto  o  nel display l'opzione "Nome unità portatile".
5. Premere il tasto . Sul display viene visualizzato il messaggio "Nome".
6. Immettere quindi il nome desiderato (al massimo 8 segni). Eventuali errori durante l'immissione sono cancellati con il tasto . Per spostare il cursore a sinistra o a destra, premere il tasto  o .
7. Premere il tasto . L'avvenuta selezione è confermata sul display.
8. Premendo il tasto  è possibile fare ritorno al livello di menu precedente.











11.4 Impostare la lingua

E' possibile scegliere lingue differenti per i testi visualizzati sul display.

1. Premere il tasto .
2. Selezionare con il tasto  o  nel display la voce di menu "Unità portatile".
3. Premere il tasto . Sul display sono visualizzate opzioni differenti.
4. Selezionare con i tasti  o  l'opzione "Lingua".
5. Premere il tasto . Sul display sono visualizzate differenti lingue da scegliere.
6. Selezionare quindi con il tasto  o  la lingua desiderata.
7. Premere il tasto . L'avvenuta selezione è confermata sul display.
8. Premendo il tasto  è possibile fare ritorno al livello di menu precedente.











11.5 Impostare colore di menu

Qui è possibile assegnare determinati colori di sfondo alle voci di menu.

1. Premere il tasto .
2. Selezionare con il tasto  o  la voce di menu "Unità portatile".
3. Premere il tasto . Sul display sono visualizzate opzioni differenti.
4. Selezionare con i tasti  o  l'opzione "Colore di menu".
5. Premere il tasto . Sul display sono visualizzati differenti colori da scegliere.
6. Selezionare quindi con il tasto  o  il colore desiderato.
7. Premere il tasto . L'avvenuta selezione è confermata sul display.
8. Premendo il tasto  è possibile fare ritorno al livello di menu precedente.















11.6 Attivare la ricezione automatica chiamate

Avendo impostato questa funzione è possibile compiere la ricezione di una chiamata in arrivo estraendo semplicemente l'unità portatile dalla stazione base. In tal caso non è quindi necessario premere appositamente il tasto di chiamata .

1. Premere il tasto .
2. Selezionare con il tasto  o  la voce di menu "Unità portatile".
3. Premere il tasto . Sul display sono visualizzate opzioni differenti.
4. Selezionare con il tasto  o  nel display l'opzione "Ricezione automatica chiamate".
5. Premere il tasto .
6. Selezionare con i tasti  o  l'opzione "On".
7. Premere il tasto . L'avvenuta selezione è confermata sul display.
8. Premendo il tasto  è possibile fare ritorno al livello di menu precedente.









11.7 Attivare codice di accesso (cifra per disponibilità linea)

Per alcuni impianti telefonici interni è necessario selezionare prima una determinata cifra (per es. "0" o "9"), prima di ricevere un segnale di libero per una linea di collegamento di rete. Procedendo all'immissione di una cifra in questo campo, si ha modo di anteporre la cifra automaticamente ogni volta che si seleziona un numero telefonico dalla rubrica telefonica o da uno degli elenchi di chiamate.



1. Premere il tasto .
2. Selezionare con il tasto  o  la voce di menu "Unità portatile".
3. Premere il tasto .
4. Selezionare con i tasti  o  l'opzione "Codice di accesso".
5. Premere il tasto .
6. Selezionare con i tasti  o  l'opzione "Impostare codice".
7. Premere il tasto .
8. Immettere le cifre richieste (massimo 4 cifre).
9. Premere il tasto .
10. Selezionare quindi l'opzione "On".
11. Premere il tasto .
12. Volendo disattivare nuovamente questo prefisso automatico, selezionare l'opzione "Off" e premere il tasto .
13. Premendo il tasto  è possibile fare ritorno al livello di menu precedente.

12 Selezione e deselegione dell'unità portatile

12.1 Selezione unità portatile

1. Premere il tasto .
2. Selezionare con il tasto  o  nel display la voce di menu "Selezione".
3. Premere il tasto .
4. Selezionare con il tasto  o  nel display l'opzione "Selezione unità portatile".
5. Premere il tasto .
6. Selezionare con il tasto  o  nel display "Base 1".

Avvertenza: Volendo registrare la propria unità portatile presso una nuova base, selezionare una base non contrassegnata da una stella. La presenza di una stella a contrassegnare la base indica che la posizione di memoria è occupata.

7. Premere il tasto  ed immettere il PIN.
8. Premere il tasto . Sul display viene visualizzata l'indicazione "Cerca base".
9. Premere presso la base il tasto di paging  fino a quando (ca. 5 secondi) non si sente un segnale acustico. La selezione è avviata.

Avvertenza: Per selezionare l'unità portatile DECT-GAP di un altro costruttore, seguire le indicazioni riportate nel manuale di istruzioni per l'uso del rispettivo costruttore e premere quindi il tasto  sulla stazione base.









10. Premere il tasto . A questo punto l'unità portatile è registrata.

All'unità portatile viene assegnato automaticamente il numero di chiamata interno libero più basso (1-5).

Alla prima unità portatile selezionata sarà assegnato il numero di chiamata 1. La seconda unità avrà il numero di chiamata interno 2. In stato di riposo il numero interno assegnato viene visualizzato sul display direttamente dopo il nome del telefono.











12.2 Deselegione unità portatile

Avvertenza: La deselegione di un'unità portatile può essere compiuta solo da parte di un'altra unità portatile ancora selezionata. Non è quindi possibile compiere questa deselegione con la stessa unità portatile che si desidera deselegionare.

1. Premere il tasto .
2. Selezionare con il tasto  o  nel display la voce di menu "Selezione".
3. Premere il tasto .
4. Selezionare con il tasto  o  nel display l'opzione "Deselegione unità portatile".
5. Premere il tasto . Immettere il numero PIN.
6. Premere il tasto . Scegliere l'unità portatile che si desidera deselegionare.
7. Premere due volte il tasto . A questo punto l'unità portatile è deselegionata.

12.3 Selezione base

In caso di registrazione dell'unità portatile presso basi differenti, è possibile impostare una base fissa oppure abilitare la ricerca automatica della stazione con la migliore ricezione. Per attivare la ricerca automatica sarà necessario assegnare l'unità portatile di nuovo ad una base fissa.

1. Premere il tasto .
2. Selezionare con il tasto  o  nel display la voce di menu "Selezione".
3. Premere il tasto .
4. Selezionare con il tasto  o  nel display l'opzione "Selezione base".
5. Premere il tasto .
6. Selezionare con il tasto  o  nel display la base desiderata oppure la modalità "Automatico".
7. Premere il tasto . La selezione è confermata.

13 Maggior numero di unità portatili

E' possibile registrare quattro ulteriori unità portatili alla stazione base. Ogni unità portatile può essere selezionata sempre per una sola stazione base. Procedendo la registrazione dell'unità portatile presso una nuova base, l'apparecchio sarà automaticamente deselezionato dalla vecchia base.

Avvertenza: Lo standard internazionale GAP consente di integrare unità portatili SWITEL così come unità portatili di altri costruttori in un unico sistema telefonico. Allo stesso modo è possibile selezionare unità portatili SWITEL per stazioni base di altri costruttori, a condizione che gli apparecchi dispongano della funzione GAP standard.

L'uso di due unità portatili offre le seguenti possibilità:

- Chiamate interne tra le unità portatili.
- Trasferimento di chiamate esterne utilizzando l'unità portatile.
- Segnalazione di chiamate esterne in arrivo presso tutte le unità portatili in uso.

Avvertenza: Se l'altra unità portatile occupa già la linea telefonica esterna, non sarà possibile compiere un'ulteriore chiamata esterna.

GAP: Generic Access Profile = Standard per l'interazione di unità portatili con stazioni base di altri costruttori.

13.1 Telefonate interne

A conclusione della selezione di un numero maggiore di unità portatili presso una stazione base sarà possibile condurre chiamate interne.

1. Premere il tasto **(INT)** ed il numero di chiamata interno dell'unità portatile, per es. **(INT) 2**.
2. La telefonata sarà ricevuta presso l'unità portatile chiamata.

Avvertenza: In caso di arrivo di una telefonata esterna durante la conduzione di una chiamata interna, si avvertono dei brevi segnali acustici ed il numero del chiamante, qualora disponibile, è visualizzato sul display.

3. Concludere la chiamata interna con il tasto **(S)**.
4. Premere il tasto **(S)** per ricevere la chiamata esterna.

13.2 Trasferimento di chiamate esterne ad un'altra unità portatile

Avendo accettato una chiamata esterna con una delle unità portatili, è possibile trasferire la chiamata esterna su un'altra unità portatile.

Per fare questo premere il tasto **(INT)** e quindi il numero di chiamata interno dell'unità portatile desiderata.

Avvertenza: Se l'unità portatile selezionata non dovesse rispondere, la chiamata potrà essere ripresa con il tasto **(INT)**.

Dopo che la chiamata interna è stata accettata dall'altra unità portatile, è possibile scegliere tra le seguenti possibilità:

1. **Riscontro / Chiamata in attesa:** E' dato modo di parlare con l'interlocutore interno e di passare nuovamente al partner di chiamata esterno premendo il tasto **(INT)**. Il numero di passaggi della chiamata tra interlocutore esterno ed interno è illimitato.
2. **Trasferire una chiamata:** Premendo il tasto **(S)** sulla prima unità portatile, la telefonata esterna è trasferita sull'unità portatile chiamata.

13.3 Condurre chiamate a conferenza

Questa funzione consente di condurre una conferenza con una chiamata esterna ed un altro interlocutore interno. In altre parole, due unità portatili possono in tal modo conversare contemporaneamente con un interlocutore esterno.

1. Compiere il collegamento con l'interlocutore esterno desiderato.
2. Premere quindi il tasto **(INT)** ed il numero di chiamata interno della seconda unità portatile desiderata.
3. Non appena il secondo interlocutore interno ha accettato la telefonata, premere il tasto **(#)** per una durata di due secondi e tutti e tre gli interlocutori sono ora in grado di conversare in conferenza.











Avvertenza: Durante la conferenza è possibile trattenere il partner di chiamata esterno premendo il tasto **(INT)**. Premendo nuovamente il tasto **(#)** è possibile tornare alla conversazione in conferenza.

4. La conferenza è terminata non appena uno degli interlocutori interni aggancia la telefonata.











14 Impostazioni di base

In questa voce di menu sono descritte le impostazioni relative alla stazione base, come per es. melodia di suoneria, volume della suoneria chiamata e PIN di sistema.

14.1 Assegnare una melodia di suoneria alla stazione base











1. Premere il tasto .
2. Selezionare con il tasto  o  nel display la voce di menu "Impostazioni di base".
3. Premere il tasto . Sul display sono visualizzate opzioni differenti.
4. Selezionare con i tasti  o  l'opzione "Suoneria chiamata base".
5. Premere il tasto . Sul display sono visualizzate differenti melodie a scelta.
6. Selezionare quindi con il tasto  o  la melodia desiderata.
7. Premere il tasto . L'avvenuta selezione è confermata sul display.
8. Premendo più volte il tasto  l'unità portatile torna in stato di riposo.

14.2 Impostare volume di suoneria chiamata della stazione base

1. Premere il tasto .
2. Selezionare con il tasto  o  nel display la voce di menu "Impostazioni di base".
3. Premere il tasto . Sul display sono visualizzate opzioni differenti.
4. Selezionare con i tasti  o  l'opzione "Volume base".
5. Premere il tasto .
6. Selezionare quindi con il tasto  o  il volume della suoneria chiamata desiderata.
7. Premere il tasto . L'avvenuta selezione è confermata sul display.
8. Premendo più volte il tasto  l'unità portatile torna in stato di riposo.

14.3 Attivare/Disattivare priorità di squillo di un'unità portatile











Qui è possibile impostare se una chiamata in arrivo dovrà essere segnalata presso tutte le unità portatili selezionate all'interno dell'impianto telefonico o se invece dovrà squillare solo una determinata unità portatile.

1. Premere il tasto .
2. Selezionare con il tasto  o  nel display la voce di menu "Impostazioni di base".
3. Premere il tasto .
4. Selezionare con il tasto  o  nel display l'opzione "Priorità unità portatile".
5. Premere il tasto .
6. Selezionare quindi l'opzione "Selezionare unità portatile".
7. Premere il tasto . Selezionare l'unità portatile desiderata.
8. Premere il tasto . Sul display sono visualizzate opzioni differenti. Selezionando per es. l'opzione "Suoneria chiamata 4", squilla prima quattro volte con priorità l'unità portatile selezionata, dopodiché iniziano a squillare anche altre unità portatili.
9. Selezionare un'opzione e premere quindi il tasto . L'avvenuta selezione è confermata sul display.
10. Premendo il tasto  è possibile fare ritorno al livello di menu precedente.













Avvertenza: Se adesso si vorranno fare squillare tutte le unità portatili contemporaneamente, selezionare al passo 6 l'opzione "Tutte le unità portatili", premere il tasto  ed uscire dal menu di impostazione.

14.4 Impostare tempi flash

E' possibile impostare due tempi flash, "Flash 1" (100 ms) o "Flash 2" (300 ms). Per l'esercizio nell'ambito di impianti telefonici interni è necessario impostare un tempo flash di 100 ms. I servizi aggiuntivi della Swisscom funzionano invece per es. con un tempo flash di 300 ms.

1. Premere il tasto .
2. Selezionare con il tasto  o  nel display la voce di menu "Impostazioni di base".
3. Premere il tasto .
4. Selezionare con i tasti  o  l'opzione "Tempi flash".
5. Premere il tasto .
6. Selezionare con il tasto  o  il tempo flash "Flash 1" (100 ms) o "Flash 2" (300 ms).
7. Premere il tasto . L'avvenuta selezione è confermata sul display.
8. Premendo il tasto  è possibile fare ritorno al livello di menu precedente.

14.5 Modificare PIN di sistema











1. Premere il tasto .
2. Selezionare con il tasto  o  nel display la voce di menu "Impostazioni di base".
3. Premere il tasto . Sul display sono visualizzate opzioni differenti.
4. Selezionare con i tasti  o  l'opzione "PIN sistema".
5. Premere il tasto . Sul display viene visualizzato il messaggio "Immettere vecchio PIN".
6. Immettere qui il vecchio codice PIN (impostazione di default: 0000). Sul display appare per ogni cifra da immettere un "*". L'immissione di una cifra errata può essere corretta cancellando prima l'errore con il tasto .
7. Una volta conclusa l'immissione dell'intero numero PIN, premere il tasto . A questo punto appare il messaggio "Immettere nuovo PIN".
8. Immettere il nuovo numero PIN (massimo 8 cifre).
9. Premere il tasto . A questo punto appare il messaggio "Confermare nuovo PIN".
10. Immettere quindi il nuovo numero PIN una seconda volta.
11. Premere il tasto . L'avvenuta selezione è confermata sul display.
12. Premendo il tasto  è possibile fare ritorno al livello di menu precedente.

Avvertenza: Avendo dimenticato il codice PIN, si prega di rivolgersi alla hotline di assistenza per ripristinare il codice originario. Per hotline di assistenza, vedi sul retro del presente manuale di istruzioni per l'uso.













15 Impostazione orario

Grazie all'orologio 24 ore con funzione sveglia e allarme integrato non si perderà più nessun appuntamento.















15.1 Impostare orario e data

1. Premere il tasto .
2. Selezionare con il tasto  o  nel display la voce di menu "Impostazione orario".
3. Premere il tasto .
4. Selezionare con il tasto  o  nel display l'opzione "Impostare orario e data".
5. Premere il tasto . Immettere quindi la data utilizzando i tasti numerici.
6. Premere il tasto . Immettere quindi l'orario utilizzando i tasti numerici.
7. Premere il tasto . Le impostazioni sono salvate.
8. Premendo il tasto  è possibile fare ritorno al livello di menu precedente.

15.2 Impostare suoneria di sveglia

1. Premere il tasto .
2. Selezionare con il tasto  o  nel display la voce di menu "Impostazione orario".
3. Premere il tasto .
4. Selezionare con il tasto  o  nel display l'opzione "Sveglia".
5. Premere il tasto .
6. Selezionare con il tasto  o  nel display l'opzione "Impostare suoneria di sveglia".
7. Premere il tasto .
8. Selezionare con il tasto  o  nel display la suoneria di sveglia desiderata.
9. Premere il tasto . La suoneria di sveglia è salvata.

15.3 Impostare orario di sveglia (ON/OFF)

1. Premere il tasto .
2. Selezionare con il tasto  o  nel display la voce di menu "Impostazione orario".
3. Premere il tasto .
4. Selezionare con il tasto  o  nel display l'opzione "Sveglia".
5. Premere il tasto .
6. Selezionare con il tasto  o  nel display l'opzione "On/Off".
7. Premere il tasto .
8. Selezionare con il tasto  o  nel display se si desidera ricevere un allarme per "Una volta" oppure "Ogni giorno" alla stessa ora.
9. Premere il tasto . Immettere l'orario desiderato.
10. Premere il tasto . Le impostazioni sono salvate.

Avvertenza: Con l'immissione dell'orario di sveglia la funzione di sveglia risulterà direttamente attivata. Sul display appare accanto alla visualizzazione dell'orario il simbolo . Per disattivare nuovamente la funzione di sveglia, scegliere nel passo 8 l'opzione "Off".

11. Premendo il tasto  è possibile fare ritorno al livello di menu precedente.

16 Eliminazione di errori

In presenza di problemi con il telefono, si prega di verificare innanzitutto quanto riportato nelle seguenti indicazioni. In caso di reclami entro il periodo di garanzia, rivolgersi al rivenditore autorizzato. Il periodo di garanzia riscopre 2 anni.

Errore	Soluzione
Il display non indica nulla	<ul style="list-style-type: none">- L'unità portatile non è attivata.- Le batterie sono scariche o difettose.
Il numero del chiamante non viene visualizzato nonostante CLIP	<ul style="list-style-type: none">- Il chiamante non è abilitato alla trasmissione del numero telefonico presso il gestore della rete telefonica.
Non è possibile collegarsi alla stazione base	<ul style="list-style-type: none">- Verificare se la registrazione alla stazione base è stata eseguita con il numero PIN corretto.
Non è possibile condurre una chiamata telefonica	<ul style="list-style-type: none">- La linea telefonica non è collegata correttamente oppure presenta un guasto. Utilizzare esclusivamente il cavo per telefono fornito.- Provare con un altro telefono se l'allacciamento telefonico in questione è funzionante.- L'alimentatore di rete non è inserito oppure si è in presenza di una caduta di tensione totale.- Le batterie sono scariche o difettose.- La distanza dalla stazione base è troppo grande.
Collegamento disturbato, si interrompe	<ul style="list-style-type: none">- La distanza dalla stazione base è troppo grande.- Luogo di installazione della stazione base errato.
La spia di controllo dello stato di carica non è accesa	<ul style="list-style-type: none">- Posizionare l'unità portatile correttamente nella stazione base, pulire le superfici di contatto presso unità portatile e stazione base con un panno morbido e asciutto.
Dopo un paio di ore sul display lampeggia il simbolo delle batterie	<ul style="list-style-type: none">- Posizionare l'unità portatile per la durata di 14 ore nella stazione base. Se ciò non dovesse essere sufficiente, sostituire le batterie standard ricaricabili.
Visualizzazione sul display è scura	<ul style="list-style-type: none">- Il difetto è causato da raggi del sole diretti, fare raffreddare l'unità portatile.
Non è stato inviato alcun messaggio SMS	<ul style="list-style-type: none">- Controllare se le immissioni del centro SMS sono corrette. Rivolgersi al gestore della propria rete telefonica.- Il telefono è collegato ad un impianto telefonico interno.- Attivare il servizio SMS presso il gestore della propria rete telefonica.

17 Informazioni importanti

17.1 Dati tecnici

Caratteristica	Valore
Standard	DECT-GAP
Alimentazione elettrica	Stazione base 220/230 V, 50 Hz
Distanza (esterni/interni)	300 m / 50 m
Autonomia di stand-by	fino a 85 ore
Autonomia di chiamata	fino a 10 ore
Batterie standard ricaricabili	2 x AAA (1.2V / 750 mAh)
Procedura di selezione	Procedura di selezione a toni (MFV)
Temperatura ambiente consentita	10°C fino 30°C
Umidità atmosferica relativa consentita	da 20% a 75%
Tempi flash	100 ms o 300 ms

DECT: **D**igital **E**uropean **C**ordless **T**elephone = Standard per telefoni senza cavo.

GAP: **G**eneric **A**ccess **P**rofile = Standard per l'interazione di unità portatili con stazioni base di altri costruttori.

17.2 Garanzia

Gli apparecchi Switel sono costruiti e collaudati in osservanza dei processi di produzione più moderni. L'impiego di materiali selezionati e tecnologie altamente sviluppate garantiscono un perfetto funzionamento ed una lunga durata in vita. Non è possibile richiamarsi alla presente garanzia nel caso in cui la causa per il malfunzionamento dell'apparecchio risale al gestore della rete telefonica o ad un eventuale impianto telefonico interno interposto. La garanzia non si estende alle batterie standard o compatte ricaricabili utilizzate all'interno degli apparecchi. Il periodo di garanzia ricopre 24 mesi a partire dalla data di acquisto.

Entro il periodo di garanzia sarà eliminato gratuitamente qualsiasi guasto relativo a difetti di materiale o di produzione. La garanzia rilasciata cessa in caso di intervento da parte dell'acquirente o di terze persone. La presente garanzia non ricopre danni dovuti all'uso o all'esercizio non conforme a quanto previsto, ad un errato montaggio o conservazione, a collegamento o installazione impropri così come a forza maggiore o a qualsiasi altro influsso esterno. In qualità di produttore ci riserviamo il diritto, in caso di reclami, di riparare o sostituire le parti difettose o di rimpiazzare l'apparecchio. Parti sostituite o apparecchi rimpiazzati divengono di nostra proprietà. Si escludono richieste di risarcimento danni, qualora non fondate su intenzione o colpa grave da parte del costruttore.

Nel caso in cui il presente apparecchio dovesse ciò nonostante presentare un difetto durante il periodo di garanzia, si prega di rivolgersi esclusivamente al negozio di rivendita dell'apparecchio SWITEL assieme al relativo scontrino di acquisto. In base alle presenti disposizioni, tutti i diritti di garanzia dovranno essere fatti valere esclusivamente nei confronti del rispettivo rivenditore autorizzato. Con il decorrere di due anni dalla data di acquisto e consegna dei nostri prodotti non sarà più possibile fare valere eventuali diritti a garanzia.

1	General Information	95
1.1	Intended use	95
1.2	Power failure	95
1.3	Installation location	95
1.4	Power supply	95
1.5	Rechargeable standard batteries	95
1.6	Charging the handset	95
1.7	Private branch exchanges	95
1.8	Disposing of old equipment	95
1.9	Notes on medical equipment	95
1.10	Temperature and ambient conditions	95
1.11	Cleaning and upkeep	96
2	Features	97
2.1	Telephone	97
3	Operating Elements	98
3.1	Handset	98
3.2	Base station / charging station	98
4	Starting Up	99
4.1	Safety notes	99
4.2	Checking the package contents	99
4.3	Connecting the base station	99
4.4	Connecting the charging station	99
4.5	Inserting the standard batteries	99
4.6	Charging the standard batteries	99
4.7	Tone dialling - DTMF	99
5	Operation	100
5.1	Display	100
5.2	Navigation using the buttons	100
5.3	Making and ending calls	100
5.4	Taking a call	100
5.5	Taking two external calls	100
5.6	Hands-free	100
5.7	Dialling phone numbers stored in the phone book	101
5.8	Displaying the call timer	101
5.9	Adjusting the receiver volume	101
5.10	Redialling	101
5.11	Muting the handset	101
5.12	Switching the handset on /off	101
5.13	Locating the handset (paging)	101
5.14	Key lock	101
5.15	Notes on range	101
6	Private Branch Exchanges / Supplementary Services	102
6.1	R button on private branch exchanges	102
6.2	R button with supplementary services provided by Swisscom	102
6.3	Dialling pause	102
7	Menu Structure	103
8	Phone Book	105
8.1	Entering phone numbers in the phone book	105
8.2	Showing details of an entry	105
8.3	Modifying entries in the phone book	105
8.4	Deleting an entry from the phone book	106
8.5	Deleting all entries from the phone book	106
8.6	VIP call (ring melody assignment)	106
9	SMS Text Messages	107
9.1	Service centres	107
9.1.1	Entering the send/receive centre numbers	107
9.2	Writing and sending	107
9.3	Sending saved SMS messages	108

- Contents -

9.4	Reading and answering	108
9.5	SMS alert signal on/off	108
9.6	Setting the SMS alert signal (Morse, Discreet, Polyphonic)	109
9.7	Delete an SMS Message	109
9.8	Delete all SMS messages	109
9.9	SMS mailbox	109
9.9.1	Adding a mailbox/user	109
9.9.2	Displaying mailbox/user data	110
9.9.3	Sending an SMS message to a personal mailbox	110
9.9.4	Changing mailbox/user data	110
9.9.5	Deleting a mailbox/user	110
10	Calls Lists	111
10.1	Caller number display (CLIP function)	111
10.2	Received calls	111
10.2.1	Displaying and calling back	111
10.2.2	Delete entry	111
10.2.3	Save entry in the phone book	111
10.3	Missed calls	112
10.3.1	Displaying and calling back	112
10.3.2	Delete entry	112
10.3.3	Save entry in the phone book	112
10.4	Dialled calls (redialling)	112
10.4.1	Displaying and calling	112
10.4.2	Delete entry	112
10.4.3	Save entry in the phone book	113
10.4.4	Deleting a calls list	113
10.4.5	Delete all calls lists	113
11	Handset	114
11.1	Assigning a ringing melody (internal and external calls)	114
11.2	Setting the ring volume	114
11.3	Entering/Changing the name of the handset	114
11.4	Setting the language	114
11.5	Setting the menu colour	114
11.6	Activating the Auto Talk function	115
11.7	Activating the PABX access code (outside line)	115
12	Registering and Deregistering Handsets	116
12.1	Register handset	116
12.2	Deregister handset	116
12.3	Select base station	116
13	Multiple Handsets	117
13.1	Internal calls (intercom function)	117
13.2	Transferring external calls to another handset	117
13.3	Conference calls	117
14	Base Settings	118
14.1	Assigning a ringing melody to the base station	118
14.2	Setting the base station ring volume	118
14.3	Activating/Deactivating handset priority	118
14.4	Setting the recall time	118
14.5	Changing the system PIN	119
14.6	Resetting the default settings	119
15	Time Settings	120
15.1	Setting the time and date	120
15.2	Setting the alarm tone	120
15.3	Entering the alarm time (ON/OFF)	120
16	Troubleshooting	121
17	Important Information	122
17.1	Technical data	122
17.2	Guarantee	122

1 General Information

Please read this operating instruction manual thoroughly.

Under no circumstances open the device or complete any repair work yourself. In the case of claims under the terms of guarantee, contact your sales outlet.

We reserve the right to make technical and optical modifications to the product during the course of product improvement.

1.1 Intended use

This telephone has been developed for use in an analogue telephone network (PSTN) within Switzerland. However, due to the different services offered by the various telecommunication network providers, there is no guarantee that the equipment will function trouble-free on every telecommunication terminal connection. Only plug the telephone connection cable into the appropriate telephone line socket. Never change the plug on the connection cable.

1.2 Power failure

The telephone cannot be used to make calls in the event of a power failure. Always keep a cord connected telephone which operates without an external power supply available in the case of emergency situations.

1.3 Installation location

The installation location is a decisive factor to ensure trouble-free operation. The equipment must be set up in the vicinity of a 230 Volt power outlet.

Do not place the base station in the direct vicinity of other electronic equipment, such as microwave ovens or hi-fi systems, since they could cause mutual disturbance. Therefore, maintain a distance of at least one meter from other electronic equipment.

Place the base station on a level, non-slip surface. Normally, the footpads on the base station do not leave any marks on the surface where it is located. However, due to the diverse types of paints and surfaces which come into question, it cannot be fully ruled out that the footpads will leave marks on the surface on which it is located.

1.4 Power supply

Only use the SWITEL power adapter plug supplied because other power supplies could destroy the telephone. There is a risk of fatal injury if the power adapter plug is opened and not disconnected from the power supply.

1.5 Rechargeable standard batteries

Do not use other rechargeable standard batteries or power packs because they could cause a short circuit. When replacing batteries, only use those of the type AAA 1.2 V 750 mAh.

Do not throw rechargeable standard batteries into a fire or immerse them in water. Do not dispose of old or defective batteries in normal domestic waste. The maximum standby and talk times specified apply to the rechargeable standard batteries supplied when used under optimum conditions. Ambient temperature, charging cycles and other external factors, such as radio loading in the area of use, can affect operating times considerably. In addition, the charge capacity is reduced for technical reasons during use or when stored at extremely high or low temperatures.



1.6 Charging the handset

If the handset warms up during the charging process, this is normal and does not represent a danger. Do not charge the handset on an external charging unit as this could damage it.

1.7 Private branch exchanges

The telephone can also be connected to a private branch exchange. The dealer where you purchased the exchange can provide information as to whether the telephone will work properly with the exchange. Due to the wide variety of private branch exchanges available, there is no guarantee that the telephone will function correctly on all PBXs.

1.8 Disposing of old equipment

To dispose of your SWITEL equipment, bring it to the local collection point provided by the public waste disposal authority (e.g. recycling center).

The adjacent symbol on the telephone signifies that this equipment must **not be disposed of in domestic waste**.



According to electric and electronic apparatus laws, old electric and electronic equipment must be sorted prior to disposal. You are contributing to environmental protection by adhering to these laws and not disposing of old equipment in domestic waste.

1.9 Notes on medical equipment

The telephone operates with a very low transmitting power. The current level of knowledge from research and technology indicates that such low transmitting power does not represent a risk to health. It has been shown, however, that portable telephones, when switched on, can affect medical equipment. Therefore, never use the telephone in the vicinity of medical equipment.

There is no evidence that DECT telephones affect heart pacemakers. However, due to the wide range of pacemakers in use, it cannot be completely ruled out.

DECT telephones can cause an unpleasant humming sound in hearing aids.

1.10 Temperature and ambient conditions

The telephone is designed for use in protected rooms with a temperature range from 10 °C to 30 °C. The base station should not be used in rooms exposed to moisture, such as bathrooms or laundries. Do not locate the device in the vicinity of sources of heat such as radiators, and never expose it to direct sunlight.

Do not use the handset in potentially explosive areas.

Prevent excessive exposure to smoke, dust, vibration, chemicals, humidity, heat or direct sunlight.

1.11 Cleaning and upkeep

Clean the housing surfaces with a dry, soft, fluff-free cloth. Never use cleaning agents or aggressive solvents. Apart from occasionally cleaning the housing, no other upkeep is necessary. The rubber footpads on the base station are not resistant to all cleaning agents. The manufacturer is not liable to any claims for damage to furniture or such.

2 Features

2.1 Telephone

- Digital DECT / GAP standard
- Up to 10 hours continuous conversation - up to 85 hours standby
- Send and receive SMS
- Voice scrambling for high level of security
- Tone dialling method (DTMF)
- Excellent display legibility through illuminated display
- Easy operation through graphical menu guidance
- Caller number display (CLIP function)
- Calls list with 50 memory segments for calls received/missed
- Redialling the last 20 call numbers
- Phone book with 150 memory segments, including names
- 24-hour clock with alarm function integrated in the handset
- Display call timer
- Can be extended by registering more GAP-compatible DECT handsets
- Multilink operation with up to five handsets
- Internal calls possible between two handsets
- Conference facility between two handsets and an external caller
- Forward calls between handsets
- Ringing melodies on the handsets and base station can be adjusted in many ways
- VIP call (melody assignment)
- Suitable for supplementary services provided by Swisscom (Hook Recall) - PBX capable
- Muting function
- Key lock
- Hands-free function on handset

DECT: **D**igital **E**uropean **C**ordless **T**elephone = Standard for cordless telephones.

GAP: **G**eneric **A**ccess **P**rofile = Standard for the interoperation of handsets and base stations from other manufacturers.

3 Operating Elements

3.1 Handset

1. Graphical colour display
2. Dialed calls / Volume + / Menu navigation upwards
3. Phone book
4. End call / On / Off
5. Missed calls / Volume - / Menu navigation downwards
6. Key lock
7. Internal and conference calls
8. R button
9. Take call / Hands-free call
10. Menu button / Select button

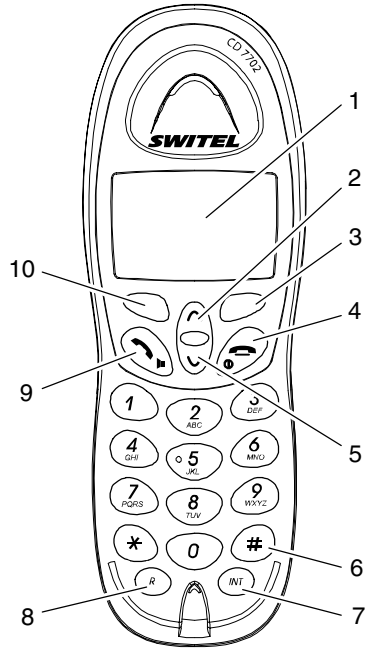

3.2 Base station / charging station

11. Paging button (locate handset)
12. Call and power indicator LED
13. Charge control lamp LED (base station)
14. Charge control lamp LED (charging station)

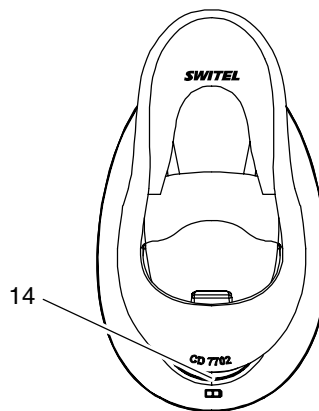
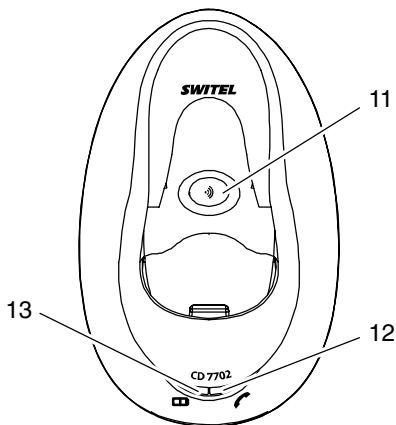

4 Starting Up

4.1 Safety notes



Caution: It is essential to read the General Information at the beginning of this manual before starting up.

4.2 Checking the package contents

The package contains:

one base station and one charging station	a telephone connection cable
two handsets	four standard batteries
two power adapter plugs with cable	an operating manual

4.3 Connecting the base station

Position the base station within reach of the telephone line socket and a power outlet. Only use the components supplied.

1. Insert the small plug on the power adapter plug cable in the corresponding socket on the underside of the base station.

NOTE: The plug cannot be connected incorrectly because the plug and socket are designed in such a way to prevent reverse poling. The plugs must snap audibly into the base station sockets.

2. Insert the small plug on the telephone connection cable in the corresponding socket on the underside of the base station.
3. Feed both cables on the underside of the base station in the cable duct provided.
4. Plug the power adapter plug in a properly installed 230 Volt power outlet. The power adapter plug from the base station must remain connected at all times.
5. Connect the telephone connection cable supplied in telephone socket.

4.4 Connecting the charging station

Place the charging station for the second handset in the vicinity of a power outlet. Plug the power adapter plug in a properly installed 230 Volt mains power outlet.

4.5 Inserting the standard batteries

In order to insert the rechargeable standard batteries in the handset, press on the top edge of the battery compartment cover and slide it downwards. Only insert standard batteries. Pay attention the correct polarity. Close the battery compartment cover.

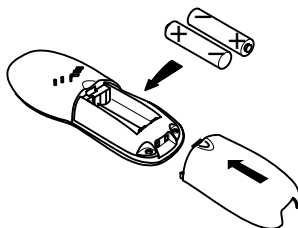

4.6 Charging the standard batteries

Place the handsets, with its display facing the front, in the base station or charging station for at least 14 hours. The charging control lamps on the base station and on the charging station light up. Failure to charge the standard batteries properly can lead to telephone malfunction.

The rechargeable standard batteries in the handset have a maximum standby time of 85 hours at room temperature. The maximum talk time is 10 hours.

The current battery charge status is indicated in the display:

Full	Half empty	Weak	Empty

4.7 Tone dialling - DTMF

This telephone implements the tone dialling method - DTMF (Dual Tone Multi Frequency). Advantages of this modern dialling method include short connection times, remote control options for other equipment, such as an answering machine, and the use of other ISDN services.

5 Operation

5.1 Display





The display indicates all the important functions by means of various icons. It is equipped with an automatic back-lighting feature which lights up the display for approx. 30 seconds when any button is pressed.

5.2 Navigation using the buttons

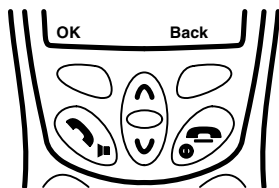
All the functions can be accessed by means of a user friendly, graphical menu. Pay attention to the texts in the display which accompany the menu because they help you to navigate correctly and intuitively.



All descriptions in this operating manual assume that the handset is in Standby mode. A beach view and the name of the handset appear in the display (preset to "Studio 1") when it is in standby mode. Standby mode is activated by pressing the  button.





Button	Description
	The current function is displayed directly above the button in the left of the display according to the operating function. The function is selected after pressing the button. When in standby, the button opens the menu.
	The current function is displayed directly above the button in the right of the display according to the operating function. The function is selected after pressing the button. When in standby, the button opens the list of names in the phone book.
	Press the button to scroll upwards in the menu.
	Press the button to scroll downwards in the menu.
	Press the button to close the menu at any point and reset the handset to standby mode.

5.3 Making and ending calls

1. Enter the phone number (max. 25 digits).

NOTE: Press the  button briefly to delete the last digit entered. Press and hold the  button to delete the entire phone number. The handset returns to standby mode.

2. Press the  button and the required connection is established.

NOTE: Alternatively, press the  button first and then enter the required phone number. It is not possible to correct wrong digits individually, as described above, using this dialling procedure.



3. To end a call, press the  button or place the handset in the base station.

5.4 Taking a call

Both the handset and base station ring. Take the handset from the base station, thus establishing the connection. The call LED on the base station flashes.

NOTE: If the Auto Talk option is deactivated, establish the connection by pressing the  button on the handset.



5.5 Taking two external calls

You will hear acoustic signals (call waiting) if a second call is received while you are carrying out a telephone conversation. The number of the second caller appears in the display. It is possible to switch between the two callers by pressing the button sequence " " " as required. One caller is put on hold while you converse with the other.

NOTE: In order to use the supplementary services provided by Swisscom, the recall time setting 300 ms has to be selected (refer to Chapter "14.4 Setting the recall time").



Caution: The caller number display and call waiting function are optional services offered by the telephone network provider. The caller number appears in the display if the service is offered by your telephone network provider. Contact your network provider for further information.

5.6 Hands-free

1. Press the  button during a call. You can then hear the caller through the loudspeaker in the handset.
2. Press the  button again to end hands-free mode.

5.7 Dialling phone numbers stored in the phone book

After phone numbers have been stored in the phone book (refer to “Entering phone numbers in the phone book”, Chapter 8.1), they can be called quickly and easily.

1. Press the  button. The phone book entries appear in the display in alphabetical order.
2. Use the  or  button to scroll to the required name in the phone book.

NOTE: To select an entry directly, press the corresponding button to enter the first letter of the name required. To select the name “Peters” directly, for example, press the  button once.



3. Press the  button and the selected phone number is dialled automatically.

5.8 Displaying the call timer

When a call is being made, the call time is indicated in minutes and seconds and the number of the person called appear in the display after about 15 seconds.

5.9 Adjusting the receiver volume

The volume of the receiver can be adjusted according to requirements.

Press the  or  button during a call to set the volume to one of five levels.

5.10 Redialling

Refer to “Dialled numbers (redialling)”, Chapter 10.4.

5.11 Muting the handset

By pressing the  button during a telephone call, the microphone in the handset is deactivated. “Secrecy” appears in the display. You can then talk to someone else without the caller being able to hear you. The loudspeaker in the handset remains switched on, so that you can continue to hear the caller.

Press the  button again to deactivate the muting function.

5.12 Switching the handset on/off

Press the  button for 2 seconds to switch the handset on and off. The display lights up or goes out accordingly.

5.13 Locating the handset (paging)

If you have mislaid your handset, you can locate it with the aid of the base station.

1. Press the Paging button  on the base station. All the handsets registered on the base station ring.
2. To stop the paging function, press the Paging button on the base station again or any button on the handset.

5.14 Key lock

If you carry the handset around a lot, you can lock the keypad so that buttons are not inadvertently activated. Calls can still be taken in the normal way even when the key lock function is activated.

5.14.1 Activating the key lock function

Press the  button on the handset for three seconds.

The “Keypad locked” message and  icon appear in the display.

5.14.2 Deactivating the key lock function

To deactivate the key lock, press the  button and then press the  button again as confirmation.

5.15 Notes on range

The handset has a range of approx. 50 meters in closed rooms and approx. 300 meters outdoors. In the case of a good connection to the base station, the  icon appears in the display.

NOTE: If the handset is moved too far from the base station, the  icon flashes and acoustic warning signals are issued. Move towards the base station, otherwise the call will be disconnected.

6 Private Branch Exchanges / Supplementary Services

The  button on the telephone is for use in private branch exchanges and when using supplementary services provided by Swisscom.

6.1 R button on private branch exchanges

If the telephone is connected to a private branch exchange, all the functions associated with the  button, such as transferring calls, automatic call back, etc., can be used. A private branch exchange requires a recall time of 100 ms (refer to Chapter 14.4). The dealer where you purchased the exchange can provide information as to whether the telephone will work properly with the exchange.

6.2 R button with supplementary services provided by Swisscom

Your SWITEL telephone supports the most important supplementary services provided by Swisscom (e.g. brokering, call waiting, three-way conferencing, etc.). Supplementary services operate with a recall time of 300 ms (refer to Chapter 14.4 for settings). Please contact Swisscom with regard to enabling the the supplementary services.

6.3 Dialling pause

In the case of private branch exchanges, it is necessary to dial a specific number (e.g. "9" or "0") in order to obtain the dialling tone for an outside line. When using some older private branch exchanges, it takes a little time before the dialling tone becomes audible. With regard to these private branch exchanges in particular, it is possible to insert an automatic pause after the number for the outside line so that the number can be dialled in a continuous process without having to wait for the dialling tone.

After entering the number for the outside line and before continuing with the actual phone number, press the  button for approx. 2 seconds. "P" appears in the display. A pause of 3 seconds is inserted between the number for the outside line and the actual phone number.

NOTE: The pause can also be entered with the phone numbers in the phone book.

- Menu Structure -

7 Menu Structure

This section describes the menu structure of your telephone. When in standby, open the menu selection by pressing the  button. For reasons of clarity, all the levels of each menu item are not always depicted.

SMS	Write Message	Options	Send to	Search
			Save	
			Insert Symbol	
			User Name	
	Inbox	Read	Options	Reply
				Forward
				Delete
	Outbox	Read	Options	Edit
				Send to
				Delete
				User Name
	Delete Messages	Inbox		
		Outbox		
		All Messages		
	Settings	Service Centres	Receive Centre	
			Sending Centre	
		Terminal Number		
		SMS Alert		
		Users		

Calls lists	Received calls	Options	Delete
			Show Details
			Save Number
	Missed calls	Options	Delete
			Show Details
			Save Number
	Dialled calls	Options	Delete
			Show Details
			Save Number
	Delete calls list	Received calls	
		Missed calls	
		Dialled calls	
		All calls	

- Menu Structure -

Handset	Ringtone	External Calls
	Ring Volume	Internal Calls
	Handset Name	
	Language	
	Menu Colour	
	Auto Talk	
	PABX Access Code	

Base settings	Base Ringtone			
	Base Volume			
	Handset Priority	All Handsets		
		Select Handset	Handset 1-5	Rings 2
				Rings 4
	Recall Mode			Rings 6
	System-PIN (default setting: 0000)			

Time settings	Alarm	On/Off	On Once
		Set Alarm Tone	Alarmtone 1-4
			On Daily
			Off
	Set Date & Time	Date	Time

Registration	Register Handset
	Select Base
	De-register

Registration	Register Handset	Base 1	System PIN (default setting: 0000)
		Base 2	
		Base 3	
		Base 4	
	Select Base	Automatic	
		Base 1	
		Base 2	
		Base 3	
		Base 4	
	De-register	System PIN (default setting: 0000)	





8 Phone Book

When in standby, press the  button to open the phone book menu. The phone book can be used to store a maximum of 150 phone numbers together with the associated names. A name can have a maximum of 16 characters. The maximum length of a phone number is 20 digits.



8.1 Entering phone numbers in the phone book

1. Press the  button. The phone book opens in the display.

NOTE: To complete the first entry in the phone book, proceed with Step 4 at this point.

2. Press the  button.
3. Use the  or  buttons to select the "Add Entry" option in the display.
4. Press the  button. The message "Name" appears in the display.
5. Enter the name using the digit keys.





NOTE: Refer to 8.1.1 to enter text.

6. Press the  button. The message "Number" appears in the display.
7. Enter the relevant phone number using the digit keys.
8. Press the  button. The entry is confirmed in the display.
9. To store more phone numbers, repeat steps 3 to 9.
10. Press the  button to reset the handset to standby mode.



8.1.1 Text entry

The digit keys are also labelled with letters for the entry of the respective letters. Letters and digits are entered by pressing the relevant key the respective number of times.

Example: To enter the name "Peter".

Press: 1 x button , 2 x button , 1 x button , 2 x button , 3 x button 



- To enter a space, press  once.
- To enter the same letter twice, press the relevant button until the letter appears then wait till the cursor automatically skips one position forward.

NOTE: Delete any incorrect entries with the  button.
Press the  or  button to move the cursor to the left or right.





8.1.2 Notes on the phone book

- Always enter the area access code with the phone numbers so that the telephone can also assign incoming local calls to a phone book entry.
- If the memory capacity of 150 phone numbers is reached, a corresponding message appears when an attempt is made to store another number. In order to create space, existing entries must be deleted.



8.2 Showing details of an entry

1. Press the  button. The phone book opens in the display.
2. Use the  or  button to select the required entry in the display.





NOTE: To select an entry directly, press the corresponding button to enter the first letter of the name required. To select the name "Peter" directly, for example, press the  button once.

3. Press the  button.
4. Use the  or  buttons to select the "Show Details" option in the display.
5. Press the  button. The name and phone number appear in the display.
6. Press the  button to move back one menu level at a time.





8.3 Modifying entries in the phone book

1. Press the  button. The phone book opens in the display.
2. Use the  or  button to select the required entry in the display.



NOTE: To select an entry directly, press the corresponding button to enter the first letter of the name required. To select the name "Peter" directly, for example, press the  button once.

3. Press the  button.
4. Use the  or  buttons to select the "Edit Entry" option in the display.
5. Press the  button.
The name appears in the display. Alter the name, if necessary, or continue with Step 6.







NOTE: For information on entering names, refer to Chapter 8.1.1.

6. Press the  button.
The number appears in the display. Alter the number, if necessary, or continue with Step 7.
7. Press the  button. The modification is confirmed in the display.
8. Press the  button once to return to the phone book in order to edit further entries.
9. Press the  button to move back one menu level at a time.







8.4 Deleting an entry from the phone book

1. Press the  button. The phone book opens in the display.
2. Use the  or  button to select the required entry in the display.

NOTE: To select an entry directly, press the corresponding button to enter the first letter of the name required. To select the name "Peter" directly, for example, press the  button once.

3. Press the  button.
4. Use the  or  buttons to select the "Delete Entry" option in the display.
5. Press the  button. A request for confirmation to delete the entry appears in the display.
6. Press the  button. Deletion is confirmed in the display.
7. Press the  button to reset the handset to standby mode.



8.5 Deleting all entries from the phone book

1. Press the  button. The phone book opens in the display.
2. Press the  button.
3. Use the  or  button to select the "Delete all phonebook" option in the display.
4. Press the  button. A request for confirmation to delete the entries appears in the display.
5. Press the  button. Deletion is confirmed in the display. New entries can be made in the phone book, if necessary.
6. Press the  button to reset the handset to standby mode.









8.6 VIP call (ring melody assignment)

Phone book entries from callers who are particularly important can be assigned a specific ringing melody. You can then recognise who is calling simply from the ringing melody.



8.6.1 Assigning a ringing melody

1. Press the  button. The phone book opens in the display.
2. Use the  or  button to select the required entry in the display.









NOTE: To select an entry directly, press the corresponding button to enter the first letter of the name required. To select the name "Peter" directly, for example, press the  button once.

3. Press the  button.
4. Use the  or  button to select the "Ringtone" option in the display.
5. Press the  button. Several melodies appear in the display for selection.
6. Use the  or  button to select the melody required in the display.
7. Press the  button. The assignment is confirmed in the display.
8. Press the  button to move back one menu level at a time.

8.6.2 Deactivating a ringing melody assignment

1. Press the  button. The phone book opens in the display.
2. Use the  or  button to select the required entry in the display.

NOTE: To select an entry directly, press the corresponding button to enter the first letter of the name required. To select the name "Peter" directly, for example, press the  button once.

3. Press the  button. Several options appear in the display.
4. Use the  or  button to select the "Ringtone" option in the display.
5. Press the  button. Several melody options appear in the display for selection as well as the "Off" option.
6. Use the  or  button to select the "Off" option in the display.
7. Press the  button. The assignment is confirmed in the display.
8. Press the  button to move back one menu level at a time.

9 SMS Text Messages

General conditions

The popular method of communication using text messages (SMS) is also possible via the conventional telephone network. The telephone can be used to send and receive text messages (SMS). Certain conditions must be fulfilled to enable text messages to be sent and received.

- The telephone connection must have the CLIP function (Calling Line Identification Presentation) available. Contact your telephone network provider to ensure that the CLIP function has been enabled on your telephone connection. It is possible that a fee will be charged for the function and it may be necessary to apply for it to be activated by your telephone network provider (e.g. Swisscom, phone number 0800 800800).
- 0190 phone numbers must not have been disabled on your conventional telephone connection.
- In order to use the SMS services, it may be necessary for your telephone network provider to activate the facility.

NOTE: Sending text messages is not currently possible in the case of call-by-call connections.

- Charges are made for sending SMS texts.
- If the receiving phone in the conventional telephone network is not provided with an SMS service or it is simply not capable of handling text messages, the SMS message is automatically converted to a voice message, i.e. read out on the phone.
- The costs accounting is completed by the telephone network provider.

Due to the constant further developments in this field, the information provided here may have changed in the meantime. Up-to-date information is available on the respective Internet pages or from the telephone network provider.

9.1 Service centres

The distribution of all text messages is performed by an SMS centre. The "Swisscom", "cablecom" and other telephone network providers offer this service. Your SWITEL telephone is set up for operation (sending and receiving text messages) via the "Swisscom" and "cablecom".

"Swisscom" Service Center

- The number for the "Swisscom" Service Center is 0622 100 000.
- The SMS function provided by "Swisscom" is already activated. No other registration is necessary.

















"cablecom" Service Center

- The number for the "cablecom" Service Center is 0435 375 370.
- The SMS function provided by "cablecom" is already activated. No other registration is necessary.

Two call numbers for the SMS function must be programmed in the handset. One phone number for sending and one phone number for receiving text messages. If you want to use the services offered by another provider, the respective call numbers must be programmed in the handset. Proceed as described in 9.1.1.

NOTE: The registering procedure for the various providers differs. Please contact the provider of your choice for the necessary call numbers of the centres and the procedure for enabling the SMS service.

9.1.1 Entering the send/receive centre numbers





1. Press the  button.
2. Use the  or  button to select the "SMS" option in the display.
3. Press the  button.
4. Use the  or  button to select the "Settings" option in the display.
5. Press the  button.
6. Use the  or  button to select the "Service Centres" option in the display.
7. Press the  button.
8. Use the  or  button to select the "Receive Centre" option in the display. Enter the phone number stipulated by the provider of your choice.
9. Press the  button.
10. Use the  or  button to select the "Sending Centre" option in the display. Enter the phone number stipulated by the provider of your choice.
11. Press the  button.
12. Press the  button to move back one menu level at a time.

9.2 Writing and sending







NOTE: It is not possible to send an SMS message from a PABX system. The "PABX Access Code" must be deactivated in order to send an SMS message (refer to Chapter 11.7).



1. Press the  button.
2. Use the  or  button to select the "SMS" option in the display.

- SMS Text Messages -





3. Press the  button.
4. Use the  or  button to select the "Write Message" option in the display.
5. Press the  button. Enter the text using the digit keys. A maximum of 160 characters are possible.

NOTE: Refer to 8.1.1 to enter text.

NOTE: To enter a symbol, press the  button while entering the text. Use the  or  button to select the "Insert Symbol" option in the display. Press the  button. Use the  or  button to select the required symbol. Press the  button. The text entry display reappears. Carry on entering your text.











6. Press the  button.
7. Use the  or  button to select the "Send to" option in the display.

NOTE: If you want to send the text message later, select the "Save" option under Step 7. The text message is stored in the "Outbox" list.

8. Press the  button.
9. Enter the phone number of the receiving party.
If the receiving party is stored in the phone book, press the  button. Use the  or  button to select the required name and then press the  button. Continue with Step 10.

10. Press the  button. Sending of the message is confirmed in the display.





9.3 Sending saved SMS messages







1. Press the  button twice.
2. Use the  or  button to select the "Outbox" option in the display.
3. Press the  button.
4. Use the  or  button to select the required SMS message in the display.
5. Press the  button twice.
6. Use the  or  button to select the "Send to" option in the display.
7. Press the  button.
8. Enter the phone number of the receiving party and then press the  button.

9.4 Reading and answering









When an SMS message is received, an acoustic signal is issued and the display indicates the receipt of a new message.

1. Press the  button. The inbox list appears in the display. SMS messages which have not been read are marked by a star.















NOTE: If you want to reply to an SMS message which has already been read, press the  button twice, use the  or  button to select the "Inbox" option in the display and press the  button. Continue with Step 2.

2. Use the  or  button to select the required SMS message in the display.
3. Press the  button. The SMS message appears in the display.
4. Press the  button.
5. Use the  or  button to select the "Reply" option in the display.
Select the "Forward" option to forward the SMS message to another phone. To forward the text message, proceed with Step 8.
6. Press the  button. Enter the text using the digit keys. A maximum of 160 characters are possible.

















NOTE: Refer to 8.1.1 to enter text.

7. Press the  button.
8. Use the  or  button to select the "Send to" option in the display.
9. Press the  button.
10. Enter the phone number of the receiving party.
If the receiving party is stored in the phone book, press the  button. Use the  or  button to select the required name and then press the  button.
11. Press the  button. Sending of the message is confirmed in the display.

9.5 SMS alert signal on/off

















1. Press the  button.
2. Use the  or  button to select the "SMS" option in the display.
3. Press the  button.
4. Use the  or  button to select the "Settings" option in the display.
5. Press the  button.
6. Use the  or  button to select the "SMS Alert" option in the display.
7. Press the  button.
8. Use the  or  button to select the "On" or "Off" option in the display.
9. Press the  button.
10. Press the  button to move back one menu level at a time.

9.6 Setting the SMS alert signal (Morse, Discreet, Polyphonic)

1. Press the  button.
2. Use the  or  button to select the "SMS" option in the display.
3. Press the  button.
4. Use the  or  button to select the "Settings" option in the display.
5. Press the  button.
6. Use the  or  button to select the "SMS Alert" option in the display.
7. Press the  button.
8. Use the  or  button to select the "Set Alert" option in the display.
9. Press the  button.
10. Use the  or  button to select the required signal tone in the display.
11. Press the  button. The modification is confirmed in the display.









9.7 Delete an SMS Message



Individual SMS messages can be deleted from the "Inbox" and "Outbox" lists.



1. Press the  button.
2. Use the  or  button to select the "SMS" option in the display.
3. Press the  button.
4. Use the  or  button to select the "Inbox" or "Outbox" option in the display.
5. Press the  button.
6. Use the  or  button to select the required SMS message from the list.
7. Press the  button.
8. Press the  button and select the "Delete" option.
9. Use the  or  button to select the "Delete" option in the display.
10. Press the  button.
11. Press the  button to confirm the function.
12. Press the  button to move back one menu level at a time.

9.8 Delete all SMS messages

All the text messages in the "Inbox" and "Outbox" lists can be deleted in one process.

1. Press the  button.
2. Use the  or  button to select the "SMS" option in the display.
3. Press the  button.
4. Use the  or  button to select the "Delete Messages" option in the display.
5. Press the  button.
6. Use the  or  button to select the "All Messages" option in the display.

NOTE: If you only want to delete the messages in one of the lists, either "Inbox" or "Outbox", use the  or  button to select the relevant option in the display.

7. Press the  button. A confirmation request appears in the display.
8. Press the  button. Deletion is confirmed in the display.
9. Press the  button to move back one menu level at a time.

















9.9 SMS mailbox

In addition to the general mailbox which already exists, it is possible to setup four further mailboxes and protect them by means of a password. Each mailbox is identified by a user name and a mailbox ID (extension number). This enables text messages to be received to which only you have access.

NOTE: SMS mailboxes can only be used if the telephone network provider offers the facility. Please request a configuration instruction manual on setting up mailbox operation from your telephone network provider.

















9.9.1 Adding a mailbox/user

NOTE: Up to four users can be added.

1. Press the  button.
2. Use the  or  button to select the "SMS" option in the display.
3. Press the  button.
4. Use the  or  button to select the "Settings" option in the display.
5. Press the  button.
6. Use the  or  button to select the "Users" option in the display.
7. Press the  button.
8. Use the  or  button to select the "Add User" option in the display.
9. Press the  button. Enter the user name using the digit keys.
10. Press the  button. Enter a password with up to five characters using the digit keys.
11. Press the  button. Enter the password again using the digit keys.
12. Press the  button. The mailbox has been set up.
13. Press the  button to move back one menu level at a time.

9.9.2 Displaying mailbox/user data

NOTE: In order to configure the mailbox operation with the telephone network provider, you need the mailbox ID (extension number). The general mailbox has the mailbox ID "0". When other users are registered, the lowest mailbox ID available is automatically assigned (1-4).

1. Press the  button.
2. Use the  or  button to select the "SMS" option in the display.
3. Press the  button.
4. Use the  or  button to select the "Settings" option in the display.
5. Press the  button.
6. Use the  or  button to select the "User" option in the display.
7. Press the  button.
8. Use the  or  button to select the required user in the display.
9. Press the  button. Enter the relevant password.
10. Press the  button.
11. Use the  or  button to select the "Terminal Number" option in the display.
12. Press the  button. The terminal number is displayed.

NOTE: The terminal number displayed under Step 12 corresponds to the mailbox ID of the telephone network provider.

13. Press the  button to move back one menu level at a time.

9.9.3 Sending an SMS message to a personal mailbox



















NOTE: SMS mailboxes can only be used if the telephone network provider offers the facility. Please request a configuration instruction manual on setting up mailbox operation from your telephone network provider.

In order to receive a text message in your personal mailbox, the sender must know your mailbox ID and append it to your phone number.



















You can send an SMS message to the receiving party containing information on your personal mailbox.

This SMS provides your SMS partner with your SMS call number including the current mailbox ID and it can be stored in the phone book. If the mailbox ID is invalid, the SMS message will not be sent.

9.9.4 Changing mailbox/user data

1. Press the  button.
2. Use the  or  button to select the "SMS" option in the display.
3. Press the  button.
4. Use the  or  button to select the "Settings" option in the display.
5. Press the  button.
6. Use the  or  button to select the "Users" option in the display.
7. Press the  button.
8. Use the  or  button to select the required user in the display.
9. Press the  button. Enter the relevant password.
10. Press the  button.
11. Use the  or  button to select one of the options to be changed.
12. Press the  button. Change the setting.
13. Press the  button. Other changes can now be made.
14. Press the  button to move back one menu level at a time.

9.9.5 Deleting a mailbox/user

1. Press the  button.
2. Use the  or  button to select the "SMS" option in the display.
3. Press the  button.
4. Use the  or  button to select the "Settings" option in the display.
5. Press the  button.
6. Use the  or  button to select the "Users" option in the display.
7. Press the  button.
8. Use the  or  button to select the "Delete User" option in the display.
9. Press the  button.
10. Use the  or  button to select the required user.
11. Press the  button. Enter the System PIN (default setting= 0000).
12. Press the  button.
13. Press the  button to move back one menu level at a time.

10 Calls Lists

10.1 Caller number display (CLIP function)

The CLIP function enables you to view the number of a caller when a call is received. If this function is available with your telephone line, the number of the caller appears in the display when the phone rings. If the caller has deactivated the transfer of his phone number, the number is not displayed. If the caller's number is stored in the phone book, the name appears in the display instead of the phone number.











The "Received calls" and "Missed calls" lists have a common memory space for 50 phone numbers. If, for example, there are 32 calls stored in the "Received calls" list, 18 memory segments remain available for "Missed calls". As soon as all 50 memory segments are occupied, the oldest entry is deleted.

NOTE: The caller number display function is an optional service offered by telephone network providers. The caller number appears in the display if the service is offered by your telephone network provider. The display of the date and time is not transferred by all telephone network providers. Contact your network provider for further information. Transfer of the phone number or the date and time is not always possible either in some private branch exchanges.













10.2 Received calls



The "Received calls" list contains all the calls taken on the phone.



10.2.1 Displaying and calling back

1. Press the  button.
2. Use the  or  button to select the "Calls Lists" option in the display.
3. Press the  button.
4. Use the  or  button to select the "Received calls" option in the display.
5. Press the  button. The list of calls received appears in the display.
6. To call back a received call, use the  or  buttons to select the required number in the display.
7. Press the  button. A connection is established.

10.2.2 Delete entry















1. Press the  button.
2. Use the  or  button to select the "Calls Lists" option in the display.
3. Press the  button.
4. Use the  or  button to select the "Received calls" option in the display.
5. Press the  button. The list of calls received appears in the display.
6. Use the  or  button to select the number required in the display.
7. Press the  button.
8. Use the  or  button to select the "Delete" option in the display.

NOTE: In addition to the "Delete" option, the "Show Details" option is also available. If the "Show Details" option is selected, press the  button to display the name and phone number. Press the  button to return to the "Received calls" list.

9. Press the  button. Deletion is confirmed in the display.
10. The "Received calls" list reappears in the handset display.
11. To delete more entries, repeat steps 6 to 9.
12. Press the  button to move back one menu level at a time.



10.2.3 Save entry in the phone book

A phone number stored in the "Received calls" list can be transferred directly to the phone book.







1. Press the  button.
2. Use the  or  button to select the "Calls Lists" option in the display.
3. Press the  button.
4. Use the  or  button to select the "Received calls" option in the display.
5. Press the  button. The list of calls received appears in the display.
6. Use the  or  button to select the number required in the display.
7. Press the  button.
8. Use the  or  buttons to select the "Save Number" option in the display.
9. Press the  button.
10. Enter the name using the digit keys .
11. Press the  button twice. The entry is confirmed in the display.
12. Press the  button to move back one menu level at a time.

10.3 Missed calls



The "Missed calls" list contains all the calls not taken so that you will not miss any calls even if your are absent. There are three ways to access the "Missed calls" list:

- Press the  button or
- If the display indicates that missed calls have been saved, press the  button or
- Proceed as described in 10.3.1.







10.3.1 Displaying and calling back

1. Press the  button.
2. Use the  or  button to select the "Calls Lists" option in the display.
3. Press the  button.
4. Use the  or  button to select the "Missed calls" option in the display.
5. Press the  button. The list of calls missed appears in the display.



NOTE: New calls are identified by a star.



6. To call back a missed call, use the  or  buttons to select the required number in the display.
7. Press the  button. A connection is established.

10.3.2 Delete entry

1. Press the  button. The list of calls missed appears in the display.
2. Use the  or  button to select the number required in the display.
3. Press the  button.
4. Use the  or  button to select the "Delete" option in the display.









NOTE: In addition to the "Delete" option, the "Show Details" option is also available.

If the "Show Details" option is selected, press the  button to display the name and phone number. Press the  button to return to the "Missed calls" list.

5. Press the  button. Deletion is confirmed in the display.
6. Press the  button to reset the handset to standby mode.

10.3.3 Save entry in the phone book

A phone number stored in the "Missed calls" list can be transferred directly to the phone book.

1. Press the  button. The list of calls missed appears in the display.
2. Use the  or  button to select the number required in the display.
3. Press the  button.
4. Use the  or  buttons to select the "Save Number" option in the display.
5. Press the  button. Enter the name using the digit keys.
6. Press the  button twice. The entry is confirmed in the display.
7. Press the  button to reset the handset to standby mode.

NOTE: When the number in the phone book is stored together with a name, the number no longer appears in the display but the name instead.



10.4 Dialed calls (redialling)

The "Dialed calls" list contains all the phone numbers you have dialled.







10.4.1 Displaying and calling

1. Press the  button. The list of dialled numbers appears in the display.



NOTE: If the number is stored in the phone book, the name associated with it also appears.



2. To redial a previously dialled number call, use the  or  buttons to select the required number in the display.
3. Press the  button. A connection is established.

10.4.2 Delete entry

1. Press the  button. The list of dialled numbers appears in the display.
2. Use the  or  button to select the number required in the display.
3. Press the  button.
4. Use the  or  button to select the "Delete" option in the display.

NOTE: In addition to the "Delete Entry" option, the "Show Details" option is also available.









If the "Show Details" option is selected, press the  button to display the name and phone number. Press the  button to return to the "Missed calls" list.

5. Press the  button. Deletion is confirmed in the display.
6. Press the  button to move back one menu level at a time.

- Calls Lists -

10.4.3 Save entry in the phone book

A phone number stored in the "Dialled calls" list can be transferred directly to the phone book.











1. Press the  button. The list of dialled numbers appears in the display.
2. Use the  or  button to select the number required in the display.
3. Press the  button.
4. Use the  or  buttons to select the "Save Number" option in the display.
5. Press the  button. Enter the name using the digit keys.
6. Press the  button twice. The entry is confirmed in the display.
7. Press the  button to move back one menu level at a time.

NOTE: When the number in the phone book is stored together with a name, the number no longer appears in the display but the name instead.



10.4.4 Deleting a calls list

It is possible to delete all the calls in one of the calls lists ("Received calls", "Missed calls" or "Dialled calls") you have selected.

NOTE: The procedure is described according to the example of the "Received calls" list. The procedure is identical for the "Missed calls" and "Dialled calls" lists.











1. Press the  button.
2. Use the  or  button to select the "Calls Lists" option in the display.
3. Press the  button.
4. Use the  or  button to select the "Delete Calls List" option in the display.
5. Press the  button.
6. Use the  or  button to select the "Received calls" option in the display.
7. Press the  button.
8. Press the  button. A request for confirmation to delete the calls list appears in the display.

NOTE: In the next step, all the entries are deleted, irrevocably, from the "Received calls" list. The deletion process is cancelled by pressing the  button.



9. Press the  button. Deletion is confirmed in the display.
10. Press the  button to move back one menu level at a time.

10.4.5 Delete all calls lists

It is possible to delete all the calls in all the calls lists ("Received calls", "Missed calls" or "Dialled calls").

1. Press the  button.
2. Use the  or  button to select the "Calls Lists" option in the display.
3. Press the  button.
4. Use the  or  button to select the "Delete Calls List" option in the display.
5. Press the  button.
6. Use the  or  button to select the "All Calls" option in the display.
7. Press the  button. A request for confirmation to delete the entries appears in the display.

NOTE: In the next step, all the entries are deleted, irrevocably, from all the calls lists ("Received calls", "Missed calls" and "Dialled calls"). The deletion process is cancelled by pressing the  button.















8. Press the  button. Deletion is confirmed in the display.
9. Press the  button to move back one menu level at a time.

11 Handset









Various settings can be defined on the handset according to individual needs.

11.1 Assigning a ringing melody (internal and external calls)



Internal and external calls can be assigned different ringing melodies. The setting procedure is described according to the example of external calls.

1. Press the  button.
2. Use the  or  button to select the "Handset" option in the display.
3. Press the  button. Several options appear in the display.
4. Use the  or  button to select the "Ringtone" option.
5. Press the  button.
6. Use the  or  button to select the "External Calls" option.
7. Press the  button. Several melodies appear in the display for selection.
8. Use the  or  button to select the required melody.
9. Press the  button. The assignment is confirmed in the display.
10. Press the  button to move back one menu level at a time.













11.2 Setting the ring volume

1. Press the  button.
2. Use the  or  button to select the "Handset" option in the display.
3. Press the  button. Several options appear in the display.
4. Use the  or  button to select the "Ring Volume" option.
5. Press the  button.
6. Use the  or  button to select the required ring volume.

NOTE: If you select the "Ringer off" option, the  icon appears in the display.











7. Press the  button. The assignment is confirmed in the display.
8. Press the  button to move back one menu level at a time.

11.3 Entering/Changing the name of the handset

1. Press the  button.
2. Use the  or  button to select the "Handset" option in the display.
3. Press the  button. Several options appear in the display.
4. Use the  or  button to select the "Handset Name" option.
5. Press the  button. The message "Name" appears in the display.
6. Enter the required name (max. 8 characters). Delete any incorrect entries with the  button. Press the  or  button to move the cursor to the left or right.
7. Press the  button. The assignment is confirmed in the display.
8. Press the  button to move back one menu level at a time.











11.4 Setting the language

Display texts and messages can appear in the display in various languages.

1. Press the  button.
2. Use the  or  button to select the "Handset" option in the display.
3. Press the  button. Several options appear in the display.
4. Use the  or  button to select the "Language" option.
5. Press the  button. Several languages appear in the display for selection.
6. Use the  or  button to select the required language.
7. Press the  button. The assignment is confirmed in the display.
8. Press the  button to move back one menu level at a time.











11.5 Setting the menu colour

The background colours of the menu options can be adjusted.

1. Press the  button.
2. Use the  or  button to select the "Handset" option.
3. Press the  button. Several options appear in the display.
4. Use the  or  button to select the "Menu Colour" option.
5. Press the  button. Several colours appear in the display for selection.
6. Use the  or  button to select the required colour.
7. Press the  button. The assignment is confirmed in the display.
8. Press the  button to move back one menu level at a time.















11.6 Activating the Auto Talk function

When the Auto Talk function has been activated, calls can be taken simply by removing the handset from the base station. The Call button  need not be pressed in addition.

1. Press the  button.
2. Use the  or  button to select the "Handset" option.
3. Press the  button. Several options appear in the display.
4. Use the  or  button to select the "Auto Talk" option.
5. Press the  button.
6. Use the  or  button to select the "On" option.
7. Press the  button. The assignment is confirmed in the display.
8. Press the  button to move back one menu level at a time.









11.7 Activating the PABX access code (outside line)

In the case of some private branch exchanges, a certain number must be dialled first (e.g. "0" or "9") before a dialling tone for an outside line is received. The digit entered here is automatically dialled before the actual phone number selected from the phone book or calls list.



1. Press the  button.
2. Use the  or  button to select the "Handset" option.
3. Press the  button. Several options appear in the display.
4. Use the  or  button to select the "PABX Access Code" option.
5. Press the  button.
6. Use the  or  button to select the "Set Code" option.
7. Press the  button. The message "Set Code" appears in the display.
8. Enter the digit to be assigned (max. 4 different digits possible).
9. Press the  button. The assignment is confirmed in the display.
10. Then select the "On" option.
11. Press the  button. The assignment is confirmed in the display.
12. If you want to deactivate the automatic access code, select the "Off" option and press the  button.
13. Press the  button to move back one menu level at a time.

12 Registering and Deregistering Handsets

12.1 Register handset

1. Press the  button.
2. Use the  or  button to select the "Registration" option in the display.
3. Press the  button.
4. Use the  or  button to select the "Register Handset" option in the display.
5. Press the  button.
6. Use the  or  button to select the "Base 1" option in the display.

NOTE: If the you want to register the handset on a new base station, select a base not marked by a star. If the base station is marked by a star, the memory location is occupied.

7. Press the  button and enter the PIN.
8. Press the  button. The message "Base Search" appears in the display.
9. Press and hold the Paging button  on the base station (approx. 5 sec.) until you hear an acoustic signal. Registration is initiated.

NOTE: In order to register a DECT-GAP handset from another manufacturer, follow the instructions in the operating manual provided by the original manufacturer and then press the  button on the base station.









10. Press the  button. The handset is now registered.

The handset is automatically assigned the lowest free internal number (1-5).

The first handset registered has the internal number 1. The second has the internal number 2. When in standby mode, the internal number appears in the handset display following the handset name.











12.2 Deregister handset

NOTE: A handset can only be deregistered by another handset still registered. This means it is not possible to complete the deregistration using the handset which is to be deregistered.

1. Press the  button.
2. Use the  or  button to select the "Registration" option in the display.
3. Press the  button.
4. Use the  or  button to select the "De-register" option in the display.
5. Press the  button. Enter the PIN.
6. Press the  button. Select the handset to be deregistered.
7. Press the  button twice. The handset is now deregistered.

12.3 Select base station

If your handset is registered on several base stations, it can be set to one specific base station or to the automatic search for the base station with the best reception. To deactivate the automatic search setting, the handset must be reset to a specific base station again.

1. Press the  button.
2. Use the  or  button to select the "Registration" option in the display.
3. Press the  button.
4. Use the  or  button to select the "Select Base" option in the display.
5. Press the  button.
6. Use the  or  button to select the required base station or "Automatic".
7. Press the  button. The selection is confirmed.

13 Multiple Handsets

Up to five handsets can be registered on the base station. Each handset can only be registered on one base station at any particular time. If you register the handset on a new base station, it is automatically deregistered from the old one.

NOTE: The standardised GAP Standard enables SWITEL handsets and even those from other manufacturers to be integrated in the telephone system. In the same way, an SWITEL handset can be registered on base stations from other manufacturers as long as they comply with the GAP Standard.

The following options are available if two handsets are used:

- Internal calls between the handsets (intercom),
- External calls can be transferred from the handset,
- Incoming external calls are received on all handsets.

NOTE: If one handset is currently using the outside line, no further external call is possible.

GAP: **Generic Access Profile** = Standard for the interoperation of handsets and base stations from other manufacturers.

13.1 Internal calls (intercom function)

As soon as several handsets are registered on a base station, they can be used for internal calls.

1. Press the **INT** button and the internal number of the handset, e.g. **INT** 2.
2. The call can be taken on the handset called.

NOTE: If an external call is received during an internal call, short acoustic signals are issued and the caller's number appears in the display, if available.

3. End the internal call by pressing the **END** button.
4. Press the **EXT** button to take an external call.

13.2 Transferring external calls to another handset

If you have taken an external call on a handset, the call can be transferred to another handset.

Press the **INT** button and then the internal number of the required handset.

NOTE: If the handset called does not answer, take the call back by pressing the **INT** button.

After the internal call has been taken by the handset called, the following options are available:

1. **Consultation / Brokering:** You can talk to the party using the other handset and then return the external caller by pressing the **INT** button. You can switch between the external and internal parties as often as necessary.
2. **Transfer call:** By pressing the **TRF** button on the first handset, the external call is transferred to the handset called.

13.3 Conference calls

An external call can be transferred to another internal handset for a conference call. This enables two handset users to confer with the external caller at the same time.

1. Establish the required connection to the external caller.
2. Press the **INT** button and then the internal number of the required, second handset.
3. When the second, internal handset user has taken the call, press the **#** button for 2 seconds and all three parties are connected in a conference call.











NOTE: During a conference call, press the **INT** button to put the external caller on hold. Press the **#** button to reactivate the conference function.

4. The conference is terminated by one of the handset users ending the call.











14 Base Settings

This menu option relates to base station settings which can be changed, such as ringing melody, ring volume and system PIN.

14.1 Assigning a ringing melody to the base station











1. Press the  button.
2. Use the  or  button to select the "Base settings" option in the display.
3. Press the  button. Several options appear in the display.
4. Use the  or  button to select the "Base Ringtone" option.
5. Press the  button. Several melodies appear in the display for selection.
6. Use the  or  button to select the required melody.
7. Press the  button. The assignment is confirmed in the display.
8. Press the  button as often as necessary to reset the handset to standby mode.

14.2 Setting the base station ring volume

1. Press the  button.
2. Use the  or  button to select the "Base settings" option in the display.
3. Press the  button. Several options appear in the display.
4. Use the  or  button to select the "Base Volume" option.
5. Press the  button.
6. Use the  or  button to select the required ring volume.
7. Press the  button. The assignment is confirmed in the display.
8. Press the  button as often as necessary to reset the handset to standby mode.

14.3 Activating/Deactivating handset priority











This function enables you to define whether all the registered handsets should ring in the event of an incoming call or one specific handset with priority should initially ring.

1. Press the  button.
2. Use the  or  button to select the "Base settings" option in the display.
3. Press the  button. Several options appear in the display.
4. Use the  or  button to select the "Handset Priority" option.
5. Press the  button. Several options appear in the display.
6. Select the "Select Handset" option.
7. Press the  button. Select the required handset.
8. Press the  button. Several options appear in the display. On selecting the "Rings 4" option, for example, the handset assigned priority rings four times before the other handsets start to ring.
9. Select an option and press the  button. The assignment is confirmed in the display.
10. Press the  button to move back one menu level at a time.











NOTE: If you want all the handsets to ring simultaneously, select the "All Handsets" option in Step 6, press the  button and exit from the setting.

14.4 Setting the recall time

Two recall times are available for selection, "Recall 1" (100 ms) or "Recall 2" (300 ms). A recall time of 100 ms is required for operation in private branch exchanges. The supplementary services provided by Swisscom, for example, operate with a recall time of 300 ms.

1. Press the  button.
2. Use the  or  button to select the "Base settings" option in the display.
3. Press the  button. Several options appear in the display.
4. Use the  or  button to select the "Recall Mode" option.
5. Press the  button. Two recall times appear in the display for selection.
6. Use the  or  button to select recall time "Recall 1" (100 ms) or "Recall 2" (300 ms).
7. Press the  button. The assignment is confirmed in the display.
8. Press the  button to move back one menu level at a time.

14.5 Changing the system PIN





1. Press the  button.
2. Use the  or  button to select the "Base settings" option in the display.
3. Press the  button. Several options appear in the display.
4. Use the  or  button to select the "System PIN" option.
5. Press the  button. The message "Enter old PIN" appears in the display.
6. Enter the old PIN (default setting: 0000). A "*" appears in the display instead of the number actually entered. If you enter an incorrect digit, delete it by pressing the  button.
7. When the old PIN has been correctly entered, press the  button. The message "Enter new PIN" appears.
8. Enter a new PIN (max. 8 digits possible).
9. Press the  button. The message "Confirm new PIN" appears.
10. Enter the new PIN once again.
11. Press the  button. The assignment is confirmed in the display.

NOTE: If you forget your PIN code, reset the telephone to its default settings (refer to Section 14.6).

12. Press the  button to move back one menu level at a time.

14.6 Resetting the default settings











NOTE: After resetting the telephone to its default, factory settings, all the data entered is deleted.

1. Press the  button for 2 seconds. The handset is switched off.
2. Press the  button for 2 seconds. The handset is switched on.
3. Press the  button before the start screen appears in the display.
4. The message "Default settings" appears in the display.
5. Press the  button. An acoustic signal is issued by the base station and handset as confirmation. The telephone is then in the state it was in on delivery.

15 Time Settings













The 24-hour clock with integrated alarm function can be used to ensure you don't miss any appointments.

15.1 Setting the time and date















1. Press the  button.
2. Use the  or  button to select the "Time settings" option in the display.
3. Press the  button.
4. Use the  or  button to select the "Set Date and Time" option in the display.
5. Press the  button. Enter the date using the digit keys.
6. Press the  button. Enter the time using the digit keys.
7. Press the  button. The data entered is stored.
8. Press the  button to move back one menu level at a time.

NOTE: The time and date are cleared in the event of a power failure or disconnection from the power supply.

15.2 Setting the alarm tone

1. Press the  button.
2. Use the  or  button to select the "Time settings" option in the display.
3. Press the  button.
4. Use the  or  button to select the "Alarm" option in the display.
5. Press the  button.
6. Use the  or  button to select the "Set Alarm Tone" option in the display.
7. Press the  button.
8. Use the  or  button to select the required alarm tone.
9. Press the  button. The alarm tone is stored.

15.3 Entering the alarm time (ON/OFF)

1. Press the  button.
2. Use the  or  button to select the "Time settings" option in the display.
3. Press the  button.
4. Use the  or  button to select the "Alarm" option in the display.
5. Press the  button.
6. Use the  or  button to select the "On/Off" option in the display.
7. Press the  button.
8. Use the  or  button to select "On Once", in which case the alarm occurs once, or "On Daily", whereby the alarm occurs at the same time each day.
9. Press the  button. Enter the time for the alarm.
10. Press the  button. The data entered is stored.

NOTE: After entering the alarm time, the alarm function is activated. The  icon appears in the display beside the time.

To deactivate the alarm function, select the "Off" option in Step 8.

11. Press the  button to move back one menu level at a time.

- Troubleshooting -

16 Troubleshooting

Should problems arise with the telephone, refer to the following information.

In the case of claims under the terms of guarantee, contact your sales outlet. There is a 2 year period of guarantee.

Faults	Corrective measures
Nothing appears in the display	<ul style="list-style-type: none"> - Handset is not switched on. - Batteries are empty or defective.
The caller's number is not displayed despite CLIP function	<ul style="list-style-type: none"> - Caller has not enabled the number transfer by the telephone network provider.
No connection to base station possible	<ul style="list-style-type: none"> - Check that the handset has been registered on the base station with the correct PIN.
No telephone calls possible	<ul style="list-style-type: none"> - The telephone line is not connected properly or is defective. Only use the telephone connection cable supplied. - Test whether the telephone connection is in order by using another telephone. - The power adaptor plug is not plugged in or there is a complete power failure. - Batteries are empty or defective. - The handset is too far from the base station.
Connection is disturbed or cut off	<ul style="list-style-type: none"> - The handset is too far from the base station. - The base station is in an unsuitable location.
The charging control lamp does not light up	<ul style="list-style-type: none"> - Place the handset correctly in the base station, clean the contact surfaces on the handset and the base station with a soft, dry cloth.
The battery icon flashes in the display after a few hours	<ul style="list-style-type: none"> - Place the handset in the base station for 14 hours. If this does not help, replace the rechargeable standard batteries.
Display is dark	<ul style="list-style-type: none"> - Caused by direct sunlight, allow handset to cool down.
SMS message cannot be sent	<ul style="list-style-type: none"> - Check the SMS centres have been entered correctly. Ask your telephone network provider. - Your telephone is integrated in a PABX system. - Request the telephone network provider to activate the SMS services.

- Important Information -

17 Important Information

17.1 Technical data

Feature	Value
Standard	DECT-GAP
Power supply	Base station, 220/230 V, 50 Hz
Range (outdoors/indoors)	300 m / 50 m
Standby	Up to 85 h
Max. talk time	Up to 10 h
Rechargeable standard batteries	2 x AAA (1.2V / 750 mAh)
Dialling method	Tone dialling method (DTMF)
Permissible ambient temperature	10°C to 30°C
Permissible relative humidity	20% to 75%
Recall times	100 ms or 300 ms

DECT: **D**igital **E**uropean **C**ordless **T**elephone = Standard for cordless telephones.

GAP: **G**eneric **A**ccess **P**rofile = Standard for the interoperation of handsets and base stations from other manufacturers.

17.2 Guarantee

SWITEL equipment is produced and tested according to the latest production methods. The implementation of carefully chosen materials and highly developed technologies ensure trouble-free functioning and a long service life. The terms of guarantee do not apply where the cause of equipment malfunction is the fault of the telephone network operator or any interposed private branch extension system. The terms of guarantee do not apply to the standard batteries or power packs used in the products. The period of guarantee is 24 months from the date of purchase.

All deficiencies resulting from material or production faults which occur during the period of guarantee will be eliminated free of charge. Rights to claims under the terms of guarantee are annulled following intervention by the purchaser or third parties. Damage caused as a result of improper handling or operation, incorrect positioning or storing, improper connection or installation, Acts of God or other external influence are not covered by the terms of guarantee. In the case of complaints, we reserve the right to repair or replace defect parts or provide a replacement device. Replacement parts or devices become our property. Rights to compensation in the case of damage are excluded where there is no evidence of intent or gross negligence by the manufacturer.

If your device shows signs of defect during the period of guarantee, please return it to the sales outlet in which you purchased the SWITEL device together with the purchase receipt. All rights to claims under the terms of guarantee in accordance with this agreement must be asserted exclusively with regard to your sales outlet. Two years after the purchase and transfer of our products, claims under the terms of guarantee can no longer be asserted.

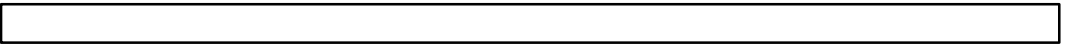

- Declaration of conformity -

WE TELGO AG
OF Route d'Englisberg 17
CH-1763 Granges-Paccot

Declare under our own responsibility that the product

MODEL: CD7702
DESCRIPTION: Cordless digital DECT telephone

Is in conformity with directives: R&TTE Directive (1999/5/EC)

COMPLIANCE IS ACHIEVED BY CONFORMITY TO THE FOLLOWING:

EN 301 406	EN 301 489-1/6	EN 60950-2000
------------	----------------	---------------

TEST REPORT NUMBER:

ET 92B-07-083	EN 301489-6 v 1.2.1	ET 94B-01-047
ET 94S-01-169-01	ET 92B-12-065-1	ET 94S-01-169-02
ET 94B-01-047-1	ET 94B-01-047-2	EN 301489-1 v 1.4.1

AUTHORISED BY:

Signed:

Name (printed):

Position in company:

Date of issue:



Selim Dusi
Managing Director
01.06.2005

Copies of this document will be held on file for a period of 10 years after the last production.



Supplier: TELGO AG, Route d'Englisberg 17,
CH-1763 Granges-Paccot
Product: CD7702

This product is intended for connection to analogue PSTN lines within Switzerland.

However, due to differences between the individual PSTNs provided in the different countries, the approval does not, of itself, give an unconditional assurance of successful operation on every PSTN network termination point.