

SWITEL

COMMUNICATION PRODUCTS

Schnurlostelefon
Téléphone sans fil
Telefono senza fili
Cordless telephone

DFT727



Bedienungsanleitung
Mode d'emploi
Istruzioni per l'uso
Operating Instructions

D

F

I

GB

SWITEL

Bedienungsanleitung 3

Mode d'emploi 44

Istruzioni per l'uso 85

Operating Instructions 126

Declaration of Conformity 168

1	Sicherheitshinweise	4
2	Telefon in Betrieb nehmen	6
3	Bedienelemente	8
4	Wie bediene ich mein Telefon?	9
5	Telefonieren	13
6	Anrufbeantworter	17
7	Nebenstellenanlagen/ Zusatzdienste	24
8	Menüstruktur	26
9	Besondere Funktionen	32
10	SMS	34
11	Erweitern des Telefonsystems	36
12	Falls es Probleme gibt	37
13	Technische Eigenschaften	39
14	Pflegehinweise / Garantie	41
15	Stichwortverzeichnis	42

Sicherheitshinweise

1 Sicherheitshinweise

Lesen Sie diese Bedienungsanleitung sorgfältig durch.

Bestimmungsgemäße Verwendung

Dieses Telefon ist geeignet für das Telefonieren innerhalb eines Telefonnetzes. Jede andere Verwendung gilt als nicht bestimmungsgemäß. Eigenmächtige Veränderungen oder Umbauten sind nicht zulässig. Öffnen Sie das Gerät in keinem Fall selbst und führen Sie keine eigenen Reparaturversuche durch.

Aufstellungsort

Vermeiden Sie Belastungen durch Rauch, Staub, Erschütterungen, Chemikalien, Feuchtigkeit, Hitze oder direkte Sonneneinstrahlung.

Verwenden Sie das Mobilteil nicht in explosionsgefährdeten Bereichen.

Netzteil



Achtung: Verwenden Sie nur das mitgelieferte Steckernetzteil, da andere Netzteile das Telefon beschädigen können. Sie dürfen den Zugang zum Steckernetzteil nicht durch Möbel oder andere Gegenstände versperren.

Aufladbare Akkus



Achtung: Werfen Sie Akkus nicht ins Feuer und tauchen Sie sie nicht ins Wasser.

Stromausfall

Bei Stromausfall kann mit dem Telefon nicht telefoniert werden. Halten Sie für Notfälle ein schnurgebundenes Telefon bereit, welches ohne externe Stromversorgung arbeitet.

Medizinische Geräte



Achtung: Benutzen Sie das Telefon nicht in der Nähe von medizinischen Geräten. Eine Beeinflussung kann nicht völlig ausgeschlossen werden.

DECT¹-Telefone können in Hörgeräten einen unangenehmen Brummtönen verursachen.

¹ DECT: Digital Enhanced Cordless Telecommunication = Standard für kabellose Telefone.

Entsorgung

Hat Ihr Gerät ausgedient, bringen Sie das Altgerät zur Sammelstelle Ihres kommunalen Entsorgungsträgers (z. B. Wertstoffhof). Das nebenstehende Symbol bedeutet, dass das Altgerät getrennt vom Hausmüll zu entsorgen ist. Nach dem Elektro- und Elektronikgerätegesetz sind Besitzer von Altgeräten gesetzlich gehalten, alte **Elektro- und Elektronikgeräte** einer getrennten Abfallerfassung zuzuführen.



Akkus entsorgen Sie beim batterievertreibenden Handel sowie bei zuständigen Sammelstellen, die entsprechende Behälter bereitstellen.



Verpackungsmaterialien entsorgen Sie entsprechend den lokalen Vorschriften.

Telefon in Betrieb nehmen

2 Telefon in Betrieb nehmen

Sicherheitshinweise



Achtung: Lesen Sie vor der Inbetriebnahme unbedingt die Sicherheitshinweise in Kapitel 1.

Verpackungsinhalt prüfen

Zum Lieferumfang gehören:

- eine Basisstation mit Netzteil
- ein Mobilteil
- ein Telefonanschlusskabel
- zwei Akkus
- eine Bedienungsanleitung

Basisstation anschließen



Achtung: Stellen Sie die Basisstation mit einem Mindestabstand von 1 m zu anderen elektronischen Geräten auf, da es sonst zu gegenseitigen Störungen kommen kann.

Schließen Sie die Basisstation wie auf der Skizze abgebildet an. Verwenden Sie aus Sicherheitsgründen nur das mitgelieferte Netzteil (6V, 600mA) sowie das beigefügte Telefonanschlusskabel.

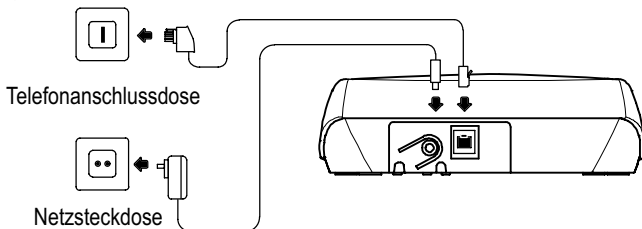

Telefon in Betrieb nehmen

Akkus einlegen

Legen Sie die Akkus in das geöffnete Akkufach ein. Verwenden Sie nur Akkus des Typs AAA Ni-MH 1,2 V. Achten Sie auf die richtige Polung! Schließen Sie das Akkufach.

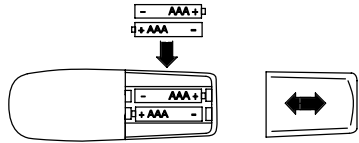

Akkus aufladen

Stellen Sie das Mobilteil bei der ersten Inbetriebnahme für mindestens 16 Stunden in die Basisstation. Haben Sie das Mobilteil richtig in die Basisstation gestellt, ertönt ein Hinweissignal. Das Mobilteil erwärmt sich beim Laden. Dies ist normal und ungefährlich. Laden Sie das Mobilteil nicht mit fremden Aufladegeräten.

Der aktuelle **Akkuladezustand** wird im Display angezeigt:



Voll



Halb



Schwach



Leer

Uhrzeit und Datum des Mobilteils einstellen

Uhrzeit und Datum stellen Sie über das Menü ein. Auf Seite 29 finden Sie die Position im Menü.

Nebenstellenanlagen

Auf Seite 24 erhalten Sie weitere Informationen, falls Sie Ihr Telefon an einer Nebenstellenanlage anschließen möchten.

Wochentag und Uhrzeit des Anrufbeantworters einstellen

Der Wochentag und die Uhrzeit Ihres Anrufbeantworters werden automatisch über das Mobilteil mitgestellt.

Bedienelemente

3 Bedienelemente

Mobilteil

- 1 Aufwärts / Anrufliste
- 2 Softkeytaste rechts
- 3 Telefonbuch
- 4 R-Taste (Flash)
- 5 Abwärts
- 6 Auflegen / Mobilteil ein/aus
- 7 Rautetaste / Tastensperre
- 8 Tonruf ausschalten / Temporäre Tonwahl
- 9 Abnehmen
- 10 Freisprechen
- 11 Zurück / Mikrofon stummschalten
- 12 Softkeytaste links
- 13 Menütaste "Info"

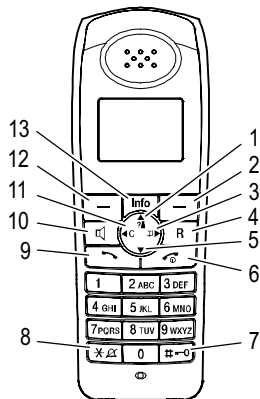

Basisstation (Anrufbeantworter)

- 1 Mobilteil suchen (Paging)
- 2 Anrufbeantworter ein / aus
- 3 LED Gesprächsanzeige
- 4 Zurück springen
- 5 Löschen
- 6 Wiedergabe / Stopp
- 7 LED Ladekontrollleuchte
- 8 Vorwärts springen
- 9 Lautstärke +
- 10 Lautstärke -

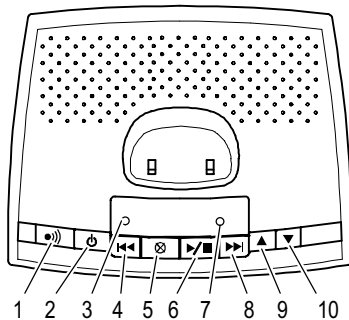











Die Tasten werden in dieser Bedienungsanleitung mit einer einheitlichen Kontur abgebildet. Abweichungen von Tastensymbolen Ihres Telefons gegenüber den hier abgebildeten Tastensymbolen sind möglich.







Wie bediene ich mein Telefon?

4 Wie bediene ich mein Telefon?



















Darstellungen und Schreibweisen

	Nummern oder Buchstaben eingeben
	Abgebildete Taste kurz drücken
2 sec 	Abgebildete Taste 2 Sekunden drücken
	Mobilteil klingelt
	Basisstation klingelt
	Mobilteil aus der Basisstation nehmen
	Mobilteil in die Basisstation stellen
 oder 	Text oder Symbole im Display
	Softkeytaste drücken  Seite 11

Symbole im Display

Display	Beschreibung
	Konstant: Die Verbindung zur Basisstation ist gut. Wartöne: Die Verbindung bricht ab. Ausgeblendet: Die Verbindung ist abgebrochen. Nähern Sie sich der Basisstation.
	Das Freisprechen ist aktiviert.  Seite 16
	Konstant: Sie führen ein Gespräch. Blinkend: Das Telefon klingelt.  Seite 13
	Der Tonruf ist ausgeschaltet.  Seite 16

Wie bediene ich mein Telefon?

Display	Beschreibung
	Das Mikrofon ist stummgeschaltet.  Seite 16
 und Tastensperre	Die Tastensperre ist aktiviert.  Seite 16
	Konstant: Anzeige der Batteriekapazität. Durchlaufend: Die Akkus werden geladen.  Seite 7
DFT727	Name des Mobilteils  Seite 36
1	Interne Rufnummer des Mobilteils  Seite 36
01.12 13:26	Anzeige des Datums und der Uhrzeit  Seite 29
 und Neue Anrufe	Es sind neue Anrufe in der Anrufliste.  Seite 31 und 25 Zusätzlich blinkt eine rote LED hinter der Info-Taste.
 und Neue SMS	Sie haben eine neue SMS ¹ .  Seite 26 und 34
	Anrufbeantworter im Telefonnetz. VMWI ² - Optionaler Service Ihres Netzbetreibers  Seite 25
	Ihr Anrufbeantworter ist eingeschaltet.  Seite 30 und 34
	Sie haben eine neue Nachricht (AB).  Seite 30 und 34

D

¹ **SMS**: Short Message Service

² **VMWI**: Visual Message Waiting Indication

Wie bediene ich mein Telefon?

Navigationstasten

Alle Beschreibungen in dieser Bedienungsanleitung gehen davon aus, dass sich das Mobilteil im Standby-Modus befindet. Den Standby-Modus erreichen Sie durch Drücken der Taste .



Die Softkeytasten (1) und (7) sind in den verschiedenen Menüs mit unterschiedlichen Funktionen belegt. Sie sind in dieser Bedienungsanleitung immer nach den darüber liegenden Texten im Display benannt.

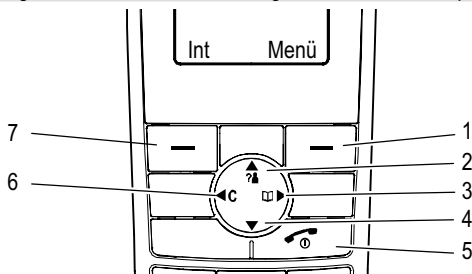



















Taste	Im Standby-Modus	Im Menü
1	- öffnet das Hauptmenü	- öffnet angezeigtes Menü
2	- öffnet die Anrufliste	- aufwärts bewegen - Ändern von Einstellungen
3	- öffnet das Telefonbuch	- nach rechts bewegen
4		- abwärts bewegen - ändern von Einstellungen
5	- Mobilteil ein-, ausschalten	- Programmier- und Speichervorgänge abrechnen
6		- nach links bewegen - eine Ebene zurück
7	- Interngespräche	- eine Ebene zurück

Wie bediene ich mein Telefon?

Navigation im Menü









Alle Funktionen sind über unterschiedliche Menüs zu erreichen. Den Weg zur gewünschten Funktion entnehmen Sie der Menüstruktur.  Seite 26

	Hauptmenü öffnen
 oder  ,  oder 	Gewünschtes Untermenü auswählen
	Untermenü öffnen
 oder 	Gewünschte Funktion auswählen
	Funktion öffnen
 oder 	Gewünschte Einstellung auswählen
	Über Tastenfeld Nummern oder Buchstaben eingeben
 oder 	Eingaben bestätigen oder speichern
 oder 	eine Ebene zurück
	Programmier- und Speichervorgänge abbrechen und in den Standby-Modus zurückkehren

 Jeder Vorgang wird automatisch abgebrochen, wenn innerhalb von 30 Sekunden keine Eingabe erfolgt.

Telefonbucheinträge erstellen - Beispiel

Wie Sie in den Menüs navigieren und Eingaben vornehmen, ist hier anhand des Beispiels **Telefonbucheinträge erstellen**, erklärt. Verfahren Sie bei allen Einstellungen wie bei diesem Beispiel.

	Telefonbuch öffnen
	Optionsmenü öffnen
 oder 	
Neuer Eintrag 	Funktion auswählen und bestätigen
Nummer:  , 	Rufnummer eingeben (max. 24 Ziffern) und bestätigen
Name:  , 	Namen eingeben (max. 15 Stellen) und speichern

5 Telefonieren

Anruf annehmen

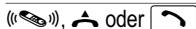

Anruf annehmen

Gespräch beenden

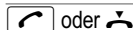

Gespräch beenden

Anrufen



Rufnummer eingeben (max. 24 Ziffern)



Bei Falscheingabe letzte Ziffer löschen



Rufnummer wählen



Sie können auch die Gesprächstaste für 2 Sekunden drücken und erhalten damit das Freizeichen. Die eingegebenen Ziffern Ihrer gewünschten Rufnummer werden sofort gewählt. Eine Korrektur einzelner Ziffern der Rufnummer ist bei dieser Form des Gesprächsaufbaus nicht möglich.

Wahlwiederholung

Ihr Telefon speichert die 20 zuletzt gewählten Rufnummern in einer Wahlwiederholungsliste.



Wahlwiederholungsliste öffnen

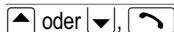

Eintrag auswählen und Verbindung herstellen

Eingegangene Anrufe zurückrufen

Ihr Telefon speichert 30 eingegangene Anrufe in einer Anrufliste.



Anrufliste öffnen



Eintrag auswählen und Verbindung herstellen

Rufnummern aus dem Telefonbuch wählen

Sie müssen Rufnummern im Telefonbuch gespeichert haben. Seite 12 und 31



Telefonbuch öffnen

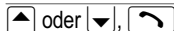

Eintrag auswählen und Verbindung herstellen

Telefonieren

Nummern verketten und übertragen

Die Funktion findet Anwendung bei komplexeren Telefondiensten wie z. B. Telefonbanking, Call by Call oder Calling-Card-Verfahren. Sie können mehrere gespeicherte Nummern nacheinander aus dem Telefonbuch übertragen. Übertragungen von Nummern aus dem Telefonbuch können Sie mit manuellen Nummereingaben kombinieren. Sie können während einer Verbindung beliebig viele Einträge aus dem Telefonbuch verketten und übertragen.



Telefonbuch öffnen



Telefonbucheintrag auswählen und Nummer übertragen

Intern telefonieren

Interne Gespräche führen

Sie müssen zwei oder mehr Mobilteile (MT1, MT2, ...) an Ihrer Basisstation angemeldet haben, um interne, kostenlose Gespräche führen zu können. Weitere Informationen Seite 36

MT1: , oder

z. B. ,

Interne Rufnummer des gewünschten Mobilteils wählen

MT2:

Internes Gespräch am anderen Mobilteil annehmen

MT1 / MT2:

Internes Gespräch beenden

Externe Gespräche intern weiterleiten

MT1: , oder

z. B. ,

Während des externen Gesprächs interne Rufnummer wählen

MT2:

Internes Gespräch am anderen Mobilteil annehmen

MT1:

Gespräch weiterleiten



Sollte sich das gerufene Mobilteil nicht melden, können Sie sich das externe Gespräch durch Drücken der Taste wieder zurückholen.

Rücksprache / Makeln

Während eines externen Gesprächs können Sie ein anderes Mobilteil anwählen, um Rücksprache zu halten. Der externe Gesprächspartner wird gehalten, während Sie mit dem internen Gesprächspartner sprechen. Sie können den Gesprächspartner beliebig oft wechseln.

MT1: Int  oder 

z. B. Mobilteil 2 

Während des externen Gesprächs interne Rufnummer wählen

MT2: 

Internes Gespräch am anderen Mobilteil annehmen

MT1: Makel 

Gesprächspartner wechseln

Konferenzgespräche führen

Ein externes Gespräch kann mit einem weiteren internen Gesprächspartner zum Konferenzgespräch geschaltet werden.

MT1: Int  oder 

z. B. Mobilteil 2 

Während des externen Gesprächs interne Rufnummer wählen

MT2: 

Internes Gespräch am anderen Mobilteil annehmen

MT1: Konf 

Konferenz starten





Sie können auch an dieser Stelle zwischen beiden Gesprächspartnern hin- und herwechseln und wieder zur Konferenz zurückschalten.

MT1 / MT2: 

Durch Auflegen eines internen Gesprächspartners wird die Konferenz beendet

Einstellen der Hörerlautstärke

Sie können während eines Gesprächs die Lautstärke in 5 Stufen anpassen.

 oder 

Gewünschte Lautstärke auswählen

Anzeige der Gesprächsdauer

Während eines entgegengenommenen Gesprächs wird die Gesprächsdauer in Stunden, Minuten und Sekunden angezeigt.

Telefonieren

Freisprechen

Nutzen Sie diese Funktion, um den Gesprächspartner über den Lautsprecher zu hören.



Freisprechen einschalten



Freisprechen ausschalten

Mikrofon im Mobilteil stummschalten

Sie können während eines Telefongesprächs das Mikrofon des Mobilteils aus- und einschalten.



Mikrofon ausschalten (stummschalten)



Mikrofon einschalten

Tastensperre

3 sec

Tastensperre einschalten



Bei eingeschalteter Tastensperre können eingehende Anrufe wie gewohnt angenommen werden.

3 sec

Tastensperre ausschalten

Tonrufmelodie des Mobilteils

Sie können die Tonrufmelodie am Mobilteil ausschalten.

3 sec

Tonrufmelodie ausschalten



Die Einstellung des Tonrufes an der Basisstation bleibt unverändert.

3 sec

Tonrufmelodie einschalten

Mobilteil suchen (Paging)

Wenn Sie Ihr Mobilteil verlegt haben, können Sie es über einen Suchton leicht wiederfinden.



Suchton starten



Suchton beenden

Mobilteil aus- und einschalten

Um die Akkus zu schonen, können Sie das Mobilteil ausschalten.

2 sec MT ausschalten?

Ja oder Nein

Bestätigen oder abbrechen

2 sec

Mobilteil einschalten

6 Anrufbeantworter

Alle Funktionen Ihres Anrufbeantworters (AB) können über das Mobilteil bedient werden. Einige Funktionen stehen Ihnen zusätzlich direkt an der Basisstation zur Verfügung.



Ihr Anrufbeantworter verfügt über eine gesprochene Bedienerführung. Beachten Sie diese Anweisungen und Hinweise.

So gelangen Sie in das Einstellungs Menü des Anrufbeantworters:

Menü	Hauptmenü öffnen
◀ oder ▶	
Anrufbeantworter	, Ok AB-Menü öffnen
◀ oder ▶	
AB-Einstellungen	, Ok Einstellungs Menü öffnen

Wochentag und Uhrzeit einstellen

Beim Abspielen der Nachrichten wird zu jeder Nachricht der Wochentag und die Uhrzeit ihres Eingangs angesagt. Der Wochentag und die Uhrzeit Ihres Anrufbeantworters wird automatisch über das Mobilteil mitgestellt ☞ Seite 29.

Anrufbeantworter ein- / ausschalten

An der Basisstation:

	Anrufbeantworter ein- / ausschalten
--	-------------------------------------

Über das Mobilteil im AB-Menü:

▲ oder ▼	
Anrufb.ein/aus	, Ok Funktion auswählen und bestätigen
▲ oder ▼	Aus oder
Ein	, Ok Einstellung auswählen und bestätigen

Maximale Aufnahmezeit

Der Anrufbeantworter speichert bis zu 99 Nachrichten. Die maximale Aufnahmezeit beträgt 15 Minuten. Ist die Speicherkapazität für neue Nachrichten erschöpft, wird kein Anruf mehr aufgezeichnet.

Anrufbeantworter

Lautstärke einstellen

Sie können die Lautstärke der Bedienungsführung in 6 Stufen einstellen.

An der Basisstation:

 oder  Lautstärke einstellen

Am Mobilteil:

 oder  Lautstärke einstellen



Anzahl Tonrufe einstellen (Verzögerung)

Sie können zwischen 2 bis 8 Tonrufen und der Einstellung **Spar-Modus** für die gebührenfreie Vor-Fernabfrage wählen.



Mit der gebührenfreien Vor-Fernabfrage können Sie feststellen, ob sich neue Nachrichten auf Ihrem Anrufbeantworter befinden.

- Befinden sich neue Nachrichten auf Ihrem Anrufbeantworter, wird Ihr Anruf bereits nach 2 Tonrufen angenommen.
- Wurden keine Nachrichten aufgezeichnet, wird Ihr Anruf erst nach 6 Tonrufen angenommen. Legen Sie vor dem 6. Tonruf auf. So fallen keine Gebühren an.

Im Einstellungs Menü:

 oder 

Antw-Verzögerung,  Funktion auswählen und bestätigen

 oder 

z. B.: Spar-Modus,  Einstellung auswählen und bestätigen

Weitere Informationen über die Fernabfrage  Seite 22

Mithören eingehender Nachrichten

Sie können eingehende Anrufe mithören, ohne den Anruf anzunehmen.

 Mithören einschalten

 Mithören ausschalten

D

Anruf übernehmen

Wenn der Anrufbeantworter bereits einen Anruf entgegengenommen hat, können Sie diesen übernehmen. Die Aufzeichnung der Nachricht wird in diesem Fall abgebrochen.

 Anruf übernehmen

Ansagemodus wählen

Ihr Anrufbeantworter stellt Ihnen zwei voreingestellte Ansagetexte zur Verfügung. Nach dem "Ansagetext mit Aufzeichnung" kann eine Nachricht hinterlassen werden. Bei dem "Ansagetext ohne Aufzeichnung" handelt es sich um eine **Nur-Ansage**, nach der keine Nachricht hinterlassen werden kann. Sie können die Ansagetexte durch eigene Ansagetexte ersetzen. Ist der Speicher des Anrufbeantworters voll, wird automatisch die Nur-Ansage wiedergegeben.

Im Einstellungs Menü:

▲ oder ▼

Antwort-Modus , Ok Funktion auswählen und bestätigen

▲ oder ▼ Mit Aufzeichng.

oder Ohne Aufzeichn. , Ok Einstellung auswählen und bestätigen

Ansagen aufzeichnen / kontrollieren oder löschen

Ansagen aufzeichnen

Die Länge der eigenen Ansage darf bis zu 2 Minuten betragen.

Im Einstellungs Menü:

▲ oder ▼

Ansagetexte , Ok Ansagen-Menü öffnen

▲ oder ▼

Ansage aufnehmen , Ok Funktion auswählen und bestätigen

▲ oder ▼ Mit Aufzeichng.

oder Ohne Aufzeichn. , Ok Ansage auswählen und bestätigen

☞, Spei Ansage sprechen und speichern

Kontrollieren der aktuell eingestellten Ansage

Im Ansagen-Menü:

▲ oder ▼

Ansagetext hören , Ok Funktion auswählen und bestätigen

▲ oder ▼ Mit Aufzeichng.



oder Ohne Aufzeichn. , Ok Ansage auswählen und bestätigen

Anrufbeantworter

Eigene Ansage löschen und zur Standardansage zurückkehren

Wenn Sie Ihre eigene Ansage löschen, wird die voreingestellte Standardansage wieder aktiviert.

Im Ansagen-Menü:



 oder 	
<input type="text" value="Ansagetext hören"/> , <input type="button" value="Ok"/>	Funktion auswählen und bestätigen
<input type="button" value="Löschen"/>	Während der Wiedergabe löschen

Memo aufzeichnen

Ein Memo ist eine Mitteilung, die wie eine eingegangene Nachricht abgehört werden kann.

Memo aufzeichnen

Im AB-Menü:





 oder 	
<input type="text" value="Memo aufnehmen"/> , <input type="button" value="Ok"/>	Funktion auswählen und bestätigen
 , <input type="button" value="Spei"/>	Memo sprechen und speichern

Aufgezeichnete Nachrichten / Memos abhören oder löschen



Nachrichten abhören

Die aufgezeichneten Nachrichten / Memos werden in der Reihenfolge wiedergegeben, in der sie eingegangen sind. Der Wochentag und die Uhrzeit werden vor dem Abspielen der jeweiligen Nachricht oder des Memos genannt.

An der Basisstation:

	Wiedergabe
	Wiedergabe stoppen
	Nachricht wiederholen
2 x 	vorherige Nachricht abspielen
	nächste Nachricht

Über das Mobilteil im AB-Menü:

 oder 	
<input type="text" value="Nachricht.hören"/> , <input type="button" value="Ok"/>	Nachrichten-Menü öffnen
Weitere Bedienung 	Tastenfunktionen im Nachrichten-Menü

Eine Nachricht löschen

An der Basisstation:

 Zu löschende Nachricht abspielen

 Nachricht löschen

Über das Mobilteil im AB-Menü:







 oder 

Nachricht.hören ,  Nachrichten-Menü öffnen

 laufende Nachricht löschen

Weitere Bedienung  Tastenfunktionen im Nachrichten-Menü

Tastenfunktionen im Nachrichten-Menü

Taste	Funktionen
	Wiedergabe / Stopp
 , 	vorherige Nachricht abspielen
	laufende Nachricht löschen
 , 	nächste Nachricht abspielen

Alle Nachrichten / Memos löschen

Es werden alle alten Nachrichten / Memos gelöscht. Neue Nachrichten / Memos bleiben erhalten.

An der Basisstation:

2 sec  Löschvorgang starten

 Löschvorgang bestätigen

Über das Mobilteil im AB-Menü:

 oder 

Alle Nachr.lösch ,  Funktion auswählen und bestätigen

Löschen?  Löschvorgang bestätigen

oder

Löschen?  Löschvorgang abbrechen

D

Anrufbeantworter

Die Fernabfrage







Sie können Ihren Anrufbeantworter anrufen, um Nachrichten abzuhören und weitere Funktionen durchzuführen. Voraussetzung dafür ist ein Telefon mit Tonwahlfunktion.

Der Sicherheitscode für die Fernabfrage



Der Sicherheitscode ist werkseitig auf "0000" eingestellt. Um eine Fernabfrage durchführen zu können, muss der werkseitige Sicherheitscode "0000" geändert werden. Sie können nur eine Fernabfrage durchführen, wenn der Sicherheitscode nicht auf "0000" eingestellt ist.

Sicherheitscode ändern

Im Einstellungsmenü:

 oder 		
Fernabf-PIN änd.		Funktion auswählen und bestätigen
Alte PIN:		Alten Sicherheitscode eingeben
Neue PIN:		Neuen Sicherheitscode eingeben
PIN wiederholen		Neuen Sicherheitscode wiederholen

Fernabfrage starten

	Eigene Rufnummer wählen
 	Während der Ansage betätigen und Sicherheitscode eingeben



Bei falscher Eingabe hören Sie erneut die Ansage des Anrufbeantworters. Wurde der Sicherheitscode dreimal falsch eingegeben, wird die Leitung automatisch getrennt.

Jetzt haben Sie die Möglichkeit, weitere Funktionen durchzuführen.  Tabelle Tastenfunktionen der Fernabfrage

Ferneinschalten des Anrufbeantworters



Eigene Rufnummer wählen



Haben Sie vergessen, Ihren Anrufbeantworter einzuschalten, wird Ihr Anruf erst nach 10 Tonrufen angenommen.

#,

Während der Ansage betätigen und Sicherheitscode eingeben

0

Anrufbeantworter ein- / ausschalten

Jetzt haben Sie die Möglichkeit, weitere Funktionen durchzuführen. Tabelle Tastenfunktionen der Fernabfrage

Tastenfunktionen der Fernabfrage



Die Fernabfrage wird automatisch abgebrochen, wenn innerhalb von 8 Sekunden keine Eingabe erfolgt.

Die folgende Tabelle verschafft Ihnen eine Übersicht über die jeweiligen Funktionen der einzelnen Tasten.

Taste	Funktionen
1	Hilfsmenü anhören
2	Wiedergabe aller Nachrichten starten
3	Wiedergabe neuer Nachrichten starten
4	Laufende Nachricht wiederholen
2 x 4	Vorherige Nachricht abhören
5	laufende Nachricht löschen
6	nächste Nachricht abhören
7	Ansagemodus auswählen: "Ansagetext mit Aufzeichnung" oder "Ansagetext ohne Aufzeichnung"
8	aktuell eingestellten Ansagetext abhören
9	aktuell eingestellten Ansagetext aufzeichnen
0	Anrufbeantworter ein- / ausschalten
#	Aufzeichnung des Ansagetextes beenden
	Das Auflegen beendet die Fernabfrage.

7 Nebenstellenanlagen / Zusatzdienste

R-Taste an Nebenstellenanlagen

Ist Ihr Telefon an einer Nebenstellenanlage angeschlossen, können Sie über die **R-Taste** Funktionen, wie z. B. Anrufe weiterleiten und automatischen Rückruf, nutzen. Lesen Sie bitte in der Bedienungsanleitung Ihrer Nebenstellenanlage, welche Flash-Zeit Sie zur Nutzung dieser Funktionen einstellen müssen. Ob Ihr Telefon an Ihrer Nebenstellenanlage einwandfrei funktioniert, erfahren Sie bei dem Händler, bei dem die Anlage gekauft wurde. Einstellen der Flash-Zeit  Seite 29.

Amtskennziffer

Bei Nebenstellenanlagen ist es erforderlich, eine bestimmte Nummer zu wählen, um ein Freizeichen für eine Amtsleitung zu bekommen. Diese Amtskennziffer können Sie speichern. Wenn Ihr Telefon diese Amtskennziffer vor einer eingegebenen Rufnummer erkennt, wird **automatisch** nach der Amtskennziffer eine **Wahlpause** eingefügt. Einstellen der Amtskennziffer  Seite 29

Wahlpause manuell eingeben

Sie können nach der Amtskennziffer **manuell** eine **Wahlpause** einfügen, um direkt weiter wählen zu können, ohne das Freizeichen abzuwarten.

2 sec

Wahlpause einfügen

Nach der Amtskennziffer wartet Ihr Telefon für 3 Sekunden mit dem Wählen der eigentlichen Rufnummer.



Die Pause kann auch bei der Eingabe von Rufnummern im Telefonbuch gespeichert werden.

R-Taste und Zusatzdienste

Ihr Telefon unterstützt Zusatzdienste Ihres Netzbetreibers, wie z. B. Makeln, An-klopfen und Konferenz. Über die **R-Taste** können Sie diese Zusatzdienste nutzen. Bitte fragen Sie Ihren Netzbetreiber, welche Flash-Zeit Sie zur Nutzung von Zusatzdiensten einstellen müssen. Zur Freischaltung von Zusatzdiensten wenden Sie sich bitte an Ihren Netzbetreiber. Einstellen der Flash-Zeit  Seite 29.

Nebenstellenanlagen/ Zusatzdienste

Anrufbeantworter im Telefonnetz

Wenn Ihr Netzbetreiber einen Anrufbeantworter im Telefonnetz für Sie bereitstellt, werden Sie mit einem Briefkasten-Symbol (**VMWI**¹) über neue Nachrichten informiert. Der Anrufbeantworter und die Information über neue Nachrichten mit einem Symbol sind Zusatzdienste Ihres Netzbetreibers. Über diese Funktionen können Sie nur dann verfügen, wenn Ihr Netzbetreiber diesen Service anbietet. Bitte fragen Sie Ihren Netzbetreiber nach weiteren Informationen.

Rufnummernanzeige (CLIP²)



Die Rufnummernanzeige ist ein Zusatzdienst Ihres Netzbetreibers. Fragen Sie Ihren Netzbetreiber nach weiteren Informationen.

Wenn Ihnen diese Funktion zur Verfügung steht, wird die Rufnummer des Anrufers bereits angezeigt, wenn das Telefon klingelt. Die Rufnummer kann jedoch nicht angezeigt und in der Anrufliste gespeichert werden, wenn der Anrufer das Übertragen seiner Rufnummer unterdrückt hat. Eine entsprechende Meldung im Display weist darauf hin.

¹ **VMWI**: Visual Message Waiting Indication

² **CLIP**: Calling Line Identification Presentation

Menüstruktur

8 Menüstruktur

Hauptmenü

In das Hauptmenü gelangen Sie durch Drücken der Softkeytaste **Menü**. Wie Sie sich im Menü bewegen und Eingaben vornehmen, zeigt Ihnen Kapitel 4.

SMS ¹

SMS schreiben				Text:	Nummer:	SMS senden	
						SMS speichern	
						SMS löschen	
Eingang	Eintrag 1	Opt	SMS beantworten		Text verwenden?		
		Eintrag 2	SMS löschen				
		Eintrag ...	Nummer anrufen				
			Nummer speichern		Name:		
Ausgangsliste	Eintrag 1	Opt	SMS senden		Nummer:		
		Eintrag 2	SMS ändern				
		Eintrag ...	SMS löschen				
SMS-Einstellung.	SMS-Center		SMS-Center 1 - 4		Nummer:		
			Sendecent.wählen	Sende-Center 1 - 4			
			SMS-Alarm	Aus			
			Ein				

D

¹ Weitere Informationen zu SMS-Textnachrichten  Seite 34.

Menüstruktur

Info Mit der Info-Taste gelangen Sie direkt in dieses Menü.

Eingang	Anrufbeantworter (-)	(Anzeige nur bei neuen Nachrichten)
	Anrufliste (-)	(Anzeige nur bei neue Anrufen)
	SMS (-)	(Anzeige nur bei neuen SMS)
SMS	☞ Seite 26	
Anrufliste	☞ Seite 31	
Info Dienste	Eintrag 1	Opt Eintrag ändern Nummer: Name:
	Eintrag ...	Eintrag löschen Löschen?

Display

Hintergrund	Hintergrund 1	(Hintergrundbild im Standby)
	Hintergrund 2	
	Hintergrund 3	
	Hintergrund 4	
	Hintergrund Aus	
Mobilteil-Name	Name:	
Display-Kontrast	Kontrast 1 - 8	
Farb-Schema	Blau / Rosa	
	Grün / Gelb	
	Violett / Braun	
Licht ein/aus	Aus	(Beleuchtung des Tastenfeldes)
	Ein	
Dimm-Modus	Aus	(Weitere Informationen zum "Dimm-Modus" ☞ Seite 33)
	Immer ein	
	Für 10 Minuten	

D

Menüstruktur

Töne

Tonruf	Ruf-Lautst.	Aus
Wartöne		Ruf-Lautst. 1 - 5
		Ruf-Lautst. ^ 1
	Ruf-Melodie	Ruf-Melodie 1 - 15
	Tastenton	Aus
		Ein
	Akku-Warnton	Aus
		Ein
	Reichweite!	Aus
		Ein

Einstellungen

MT-Einstellungen	Direktruf	PIN eingeben ² ⚡
	⚡ Direktruf ein	Nummer:
	Direktruf aus	
	Basis-Auswahl	Basis A
		Basis ...
	Direktannahme	Aus
		Ein
	Notruf-Nr. ⚡	
	⚡ Notruf-Nr. 1	Nummer:
	Notruf-Nr. ...	
	Rücksetzen	Rücksetzen?
	Sprache	Deutsch
		Français / Italiano

¹ Bei dieser Einstellung nimmt die Lautstärke bei jedem weiteren Tonruf zu.

² Der PIN-Code ist werkseitig auf "0000" eingestellt.

↙	Basis-Einstellg.	Tonruf	Ruf-Lautst.	Aus
				Ruf-Lautst. 1 - 5
			Ruf-Melodie	Ruf-Melodie 1 - 5
		Wahlverfahren	Tonwahl(DTMF)	
			Impulswahl	
		Amtskennziffer	Nummer:	
		PIN ändern ¹	Alte PIN:	Neue PIN: ➔
			➔	PIN wiederholen
		Rücksetzen	Rücksetzen?	PIN eingeben ➔
			➔	Bitte warten!
	Datum / Zeit	Datum:	Zeit:	
	Flash-Zeit	Flash 1 - 8		
	MT anmelden	Basis A * 2	PIN eingeben	Suche Basis!
		Basis B		
		Basis C		
		Basis D		
	MT abmelden	PIN eingeben	Mobilteil 1	MT abmelden?
			Mobilteil ...	

¹ Der PIN-Code ist werkseitig auf "0000" eingestellt.

² Es stehen Ihnen zur Anmeldung von Basisstationen 4 Speicherplätze zur Verfügung. Speicherplätze die mit einem Stern gekennzeichnet sind, wurden bereits belegt. Wird ein belegter Speicherplatz zur Anmeldung verwendet, wird die alte Registrierung auf diesem Speicherplatz überschrieben.

Menüstruktur

Anrufbeantworter¹

Nachricht.hören		
Alle Nachr.lösch	Löschen?	
Anrufb.ein/aus	Aus	
	Ein	
AB-Einstellungen	Antwort-Modus	Mit Aufzeichng.
		Ohne Aufzeichn.
	Ansagetexte	Mit Aufzeichng. Ansage aufnehmen
		Ohne Aufzeichn.
		Mit Aufzeichng. Ansagetext hören
		Ohne Aufzeichn.
	Aufnahmezeit	30 / 60 / 120 s
		Unbeschränkt
	Antw-Verzögerung	Spar-Modus
		2 Rufe
		4 Rufe
		6 Rufe
		8 Rufe
	Fernabf-PIN änd.	Alte PIN: Neue PIN: ▶
		▶ PIN wiederholen
Memo aufnehmen		

¹ Weitere Informationen zum Anrufbeantworter  Seite 17.

Telefonbuch

In das Telefonbuch gelangen Sie durch Drücken der Taste .

Telefonbuch

Eintrag 1	Opt	Neuer Eintrag	Nummer:	Name: ¹
Eintrag 2		Eintrag ändern	Nummer:	Name: ¹
Eintrag ...		Eintrag löschen	Löschen?	
		Alle löschen	Löschen?	

Anrufliste

In die Anrufliste gelangen Sie durch Drücken der Taste .

Anrufliste ²

Eintrag 1	Opt	Eintrag löschen	Löschen?
Eintrag 2		Liste löschen	Löschen?
Eintrag ...		Details	
		Nummer speichern	Name: ¹

¹ Die Zahlentasten sind mit Buchstaben beschriftet. Durch mehrmaliges Drücken der entsprechenden Taste können Buchstaben, Zahlen und Sonderzeichen eingegeben werden. Mit der Sterntaste können Sie zwischen Groß- und Kleinschreibung oder Zahleneingabe umschalten

² Für das Anzeigen und Speichern von Rufnummern in Anruflisten wird die Rufnummernanzeige (**CLIP**³) benötigt. Die Rufnummernanzeige ist ein Zusatzdienst Ihres Netzbetreibers. Fragen Sie Ihren Netzbetreiber nach weiteren Informationen. Weitere Informationen über die Rufnummernanzeige  Seite 25.

³ **CLIP**: Calling Line Identification Presentation

Besondere Funktionen

9 Besondere Funktionen

Automatische Gesprächsannahme (Direktannahme)

Haben Sie die Funktion aktiviert, wird ein Anruf automatisch beim Herausnehmen des Mobilteils aus der Basisstation angenommen. Direktannahme einstellen

☞ Seite 28.

Wahlverfahren

Sie können Ihr Telefon sowohl an den analogen Vermittlungsstellen (Impuls-Wahlverfahren) als auch an den neuen digitalen Vermittlungsstellen (Ton-Wahlverfahren) betreiben. Wahlverfahren einstellen ☞ Seite 29.

Temporäre Tonwahl

Können Sie Ihr Telefon nur mit dem Impuls-Wahlverfahren betreiben, brauchen Sie nicht auf die Vorteile des Ton-Wahlverfahrens (z. B.: Abfrage eines Anruferantworters im Telefonnetz) zu verzichten. Während einer bestehenden Verbindung können Sie vorübergehend zum Ton-Wahlverfahren wechseln.

2 sec

Während des Gesprächs drücken

Nach Gesprächsende wird wieder automatisch auf das Impuls-Wahlverfahren zurückgeschaltet.

Direktruf

Mit der Funktion haben Sie die Möglichkeit, eine bestimmte Rufnummer zu speichern, die bei Betätigen einer beliebigen Taste (außer Softkeytaste) automatisch angerufen wird. Direktruf aktivieren ☞ Seite 28.

, oder

,

Direktruf deaktivieren

Notrufnummern

Sie können in Ihrem Mobilteil 4 Notrufnummern speichern. Diese Notrufnummern können trotz eingeschalteter Tastensperre gewählt werden. Notrufnummern speichern  Seite 28.

Dimm-Modus

Einstellung	Auswirkung
Aus	Die Beleuchtung des Displays wird nach 30 Sekunden ausgeschaltet.
Immer ein	Die Beleuchtung des Displays wird nach 30 Sekunden gedimmt und bleibt eingeschaltet.
Für 10 Minuten	Die Beleuchtung des Displays wird nach 30 Sekunden gedimmt und nach Ablauf von 10 Minuten ausgeschaltet.

10 SMS

SMS Voraussetzungen

Ihr Telefonanschluss muss über das Leistungsmerkmal **CLIP**¹ verfügen. Vergewissern Sie sich bei Ihrem Netzbetreiber, dass dieses Leistungsmerkmal an Ihrem Telefonanschluss freigeschaltet ist. Um den **SMS**²-Dienst zu nutzen, muss dieser bei Ihrem Netzbetreiber aktiviert werden.

- Nicht von jeder Nebenstellenanlage können SMS versandt werden.



Wenn Sie von einer Nebenstellenanlage SMS versenden möchten, speichern Sie vor den Service Center Nummern in Ihrem Mobilteil die Amtskennziffer Ihrer Nebenstellenanlage ein.

- Bei Call-by-Call-Verbindungen ist der SMS-Versand derzeit nicht möglich.
- Das Senden von SMS-Nachrichten ist kostenpflichtig.
- Nutzt der Empfänger im Festnetz keinen SMS-Dienst oder kann sein Telefon generell keine SMS empfangen, wird die SMS automatisch als Sprachmeldung zugestellt.
- Die Kostenberechnung erfolgt über Ihren Netzbetreiber.

SMS Service Center

Die Verteilung von SMS-Nachrichten erfolgt über ein Service Center. Wenn Sie SMS-Textnachrichten versenden möchten, müssen Sie eine Service Center Nummer in Ihrem Mobilteil einprogrammieren ☞ Seite 26. Bitte erfragen Sie beim Anbieter Ihrer Wahl die erforderliche Service Center Nummer und die Vorgehensweise zur Freischaltung des SMS-Dienstes.



Ihr Telefon ist zum Versenden von SMS-Textnachrichten vorbereitet. Es sind bereits Service Center Nummern in Ihrem Mobilteil einprogrammiert. Aktivieren Sie das gewünschte Service Center im SMS Menü. ☞ Seite 27

Service Center 1	Service Center 2
Swisscom: 0622100000	Cablecom: 0435375370
Service Center 3	Service Center 4
Leer	Leer

¹ **CLIP**: Calling Line Identification Presentation

² **SMS**: Short Message Service

Text eingeben

Zur Eingabe von Text sind die Zahlentasten mit Buchstaben beschriftet. Durch mehrmaliges Drücken der entsprechenden Taste können Buchstaben, Zahlen und Sonderzeichen eingegeben werden.

0 , 1 oder #	Sonderzeichen eingeben
*	Zwischen Groß- und Kleinschreibung oder Zahleneingabe umschalten
Lösch	Letzte Stelle löschen
2 sec Lösch	Alles Löschen

SMS Hinweissignal (Alarm)

Wenn Sie neue SMS Textnachrichten empfangen haben, werden Sie mit einem Hinweissignal darauf aufmerksam gemacht. Dieses Signal können Sie aus- und einschalten. Hinweissignal aus- einschalten ☞ Seite 27.

11 Erweitern des Telefonsystems

Über den international genormten **GAP**¹ Standard ist die Kompatibilität von Mobilteilen und Basisstationen verschiedener Hersteller geregelt. So ist es möglich, SWITEL-Geräte und Geräte anderer Hersteller zusammen in einem Telefonsystem zu integrieren. Es ist jedoch möglich, dass einige Funktionen nicht zur Verfügung stehen.

Mehrere Mobilteile

Sie können insgesamt 5 Mobilteile an Ihrer Basisstation anmelden.

Anmelden von Mobilteilen

Bevor Sie ein Mobilteil anmelden, müssen Sie die Basisstation in den Registriermodus setzen.

10 sec   Registriermodus starten

Melden Sie nun das Mobilteil an  Seite 29. Benutzen Sie zur Anmeldung den aktuell eingestellten PIN-Code  Seite 29.

Nach dem Anmelden wird dem Mobilteil eine interne Rufnummer gegeben. Diese interne Rufnummer wird im Display angezeigt.



Um Mobilteile anderer Hersteller anzumelden, lesen Sie bitte deren Bedienungsanleitungen.

Abmelden von Mobilteilen





Jedes Mobilteil kann sich selbst oder andere an dieser Basisstation angemeldete Mobilteile abmelden. Im Display des abgemeldeten Mobilteils erscheint dann die Meldung "Suche Basis!".

Abmelden von Mobilteilen  Seite 29.

Mehrere Basisstationen

Sie können die Reichweite Ihres Mobilteils vergrößern, wenn Sie es an mehrere Basisstationen anmelden. Es kann gleichzeitig an 4 verschiedene Basisstationen angemeldet sein. Jede Basisstation benötigt eine eigene Telefonsteckdose. Es können Anschlüsse mit der selben und auch mit unterschiedlichen Rufnummern sein.

Setzen Sie weitere Basisstationen in den Registriermodus. Melden Sie das Mobilteil an  Seite 29. Über das Menü "Basis-Auswahl" wählen Sie die Basisstation, über die Sie telefonieren möchten  Seite 28.

¹ **GAP**: **Generic Access Profile** = Standard für das Zusammenwirken von Mobilteilen und Basisstationen anderer Hersteller.

12 Falls es Probleme gibt

Haben Sie Probleme mit Ihrem Telefon, kontrollieren Sie zuerst die folgenden Hinweise. Bei technischen Problemen oder Garantieansprüchen wenden Sie sich an Ihren Fachhändler. Die Garantiezeit beträgt 2 Jahre.

Fragen und Antworten

Fragen	Antworten
Keine Verbindung zur Basisstation möglich	<ul style="list-style-type: none">- Prüfen Sie, ob Sie sich mit dem richtigen PIN-Code an der Basisstation angemeldet haben. ☞ Seite 29
Kein Telefongespräch möglich	<ul style="list-style-type: none">- Das Telefon ist nicht korrekt angeschlossen oder gestört. Verwenden Sie nur das mitgelieferte Telefonanschlusskabel.- Testen Sie mit einem anderen Telefon, ob Ihr Telefonanschluss in Ordnung ist.- Das Netzteil ist nicht eingesteckt oder es liegt ein totaler Stromausfall vor.- Die aufladbaren Akkus sind leer oder defekt.- Sie haben sich zu weit von der Basisstation entfernt.- Wahlverfahren falsch eingestellt. ☞ Seite 29
Verbindung abgehackt, fällt aus	<ul style="list-style-type: none">- Sie haben sich zu weit von der Basisstation entfernt.- Falscher Aufstellungsort der Basisstation.
Das System reagiert nicht mehr	<ul style="list-style-type: none">- Setzen Sie alle Funktionen in den Werkzustand zurück. ☞ Seite 39- Ziehen Sie kurzzeitig das Netzteil aus der Steckdose.- Entfernen Sie kurzzeitig die Akkus aus dem Mobilteil.

Falls es Probleme gibt

Fragen	Antworten
Die Akkus sind in kürzester Zeit leer	<ul style="list-style-type: none">- Die Akkus sind leer oder defekt.- Stellen Sie das Mobilteil richtig auf die Basisstation. Reinigen Sie die Kontaktflächen am Mobilteil und an der Basisstation mit einem weichen, trockenen Tuch.- Stellen Sie das Mobilteil für 16 Stunden in die Basisstation.
Die Rufnummernanzeige (CLIP ¹) funktioniert nicht	<ul style="list-style-type: none">- Die Rufnummernanzeige ist ein optionaler Service Ihres Netzbetreibers. Bitte fragen Sie Ihren Netzbetreiber nach weiteren Informationen.- Der Anrufer hat das Übertragen seiner Rufnummer unterdrückt.
Der Anrufbeantworter nimmt keine Nachrichten / Memos auf	<ul style="list-style-type: none">- Stellen Sie sicher, dass der Anrufbeantworter korrekt angeschlossen und eingeschaltet ist.- Prüfen Sie, ob der Speicher des Anrufbeantworters voll ist. Löschen Sie ggf. Nachrichten aus dem Speicher. ☞ Seite 20
Sie können keine Fernabfrage durchführen	<ul style="list-style-type: none">- Prüfen Sie, ob Sie den richtigen Sicherheitscode für die Fernabfrage benutzen. ☞ Seite 22- Das Telefon, das Sie für die Fernabfrage nutzen, muss auf Ton-Wahlverfahren eingestellt sein.

¹ CLIP: Calling Line Identification Presentation

13 Technische Eigenschaften

Technische Daten

Merkmal	Wert
Standard	DECT-GAP¹
Stromversorgung (Basisstation)	Eingang: 220/230V, 50Hz Ausgang: 6V, 600mA
Reichweite	Außen: ca. 300 m Innen: ca. 50 m
Standby	bis zu 100 h
Max. Gesprächsdauer	bis zu 10 h
Aufladbare Akkus	2 x 1.2 V, Größe: AAA
Wahlverfahren	Ton-Wahlverfahren Impuls-Wahlverfahren
Zulässige Umgebungstemperatur	10°C bis 30°C
Zulässige relative Luftfeuchtigkeit	20% bis 75%
Flash-Funktion	80 ms, 100 ms, 120 ms, 180 ms, 250 ms, 300 ms, 600 ms, 800 ms

Werkseinstellungen

Mobilteil

Werkseinstellungen wiederherstellen  Seite 28

Sprache:	Deutsch	Notrufnummer 1:	Leer
Tonrufmelodie:	6	Notrufnummer 2:	Leer

¹ **DECT**: Digitally Enhanced Cordless Telecommunication = Standard für kabellose Telefone.

GAP: Generic Access Profile = Standard für das Zusammenwirken von Mobilteilen und Basisstationen anderer Hersteller.

Technische Eigenschaften

Tonruflautstärke:	5	Notrufnummer 3:	Leer
Hörerlautstärke:	3	Notrufnummer 4:	Leer
Freisprechlautstärke:	3	Tastenton:	Ein
Telefonbuch:	Leer	MT-Name:	DFT727
Anrufliste:	Leer	SMS:	Leer
Wahlwiederholung:	Leer	SMS Hinweissignal:	Ein
Babycall:	Aus/Leer	Direktannahme:	Ein
Amtskennzahl:	Leer	Displaykontrast:	4
Tastensperre:	Aus	Menüfarbe:	Blau
Akkubarnton:	Ein	Tastenbeleuchtung:	Ein
Reichweitenwarnton:	Ein	Hintergrundbild:	Himmel
Dimm-Modus:	Für 10 Minuten		

Basisstation

Werkseinstellungen wiederherstellen  Seite 29

Tonrufmelodie:	1	Flash-Zeit:	100 ms
Tonruflautstärke:	5	Wahlverfahren:	Tonwahl
VIP-Telefonbuch:	Leer	PIN:	0000

Anrufbeantworter

Verzögerung:	4 Tonrufe	Ansagemodus	mit Aufzeichnung
Anrufbeantworter:	Ein	Lautstärke:	3

Konformitätserklärung

Dieses Gerät erfüllt die Anforderungen der EU-Richtlinie:

1999/5/EG Richtlinie über Funkanlagen und Telekommunikations-einrichtungen und die gegenseitige Anerkennung ihrer Konformität. Die Konformität mit der o. a. Richtlinie wird durch das CE-Zeichen auf dem Gerät bestätigt.

Die komplette Konformitätserklärung finden Sie auf der Rückseite dieser Bedienungsanleitung.



14 Pflegehinweise / Garantie

Pflegehinweise

- Reinigen Sie die Gehäuseoberflächen mit einem weichen und fusselfreien Tuch.
- Verwenden Sie keine Reinigungsmittel oder Lösungsmittel.

Garantie

SWITEL - Geräte werden nach den modernsten Produktionsverfahren hergestellt und geprüft. Ausgesuchte Materialien und hoch entwickelte Technologien sorgen für einwandfreie Funktion und lange Lebensdauer. Ein Garantiefall liegt nicht vor, wenn die Ursache einer Fehlfunktion des Gerätes bei dem Telefonnetzbetreiber oder einer eventuell zwischengeschalteten Nebenstellenanlage liegt. Die Garantie gilt nicht für die in den Produkten verwendeten Batterien, Akkus oder Akkupacks. Die Garantiezeit beträgt 24 Monate, gerechnet vom Tage des Kaufs.

Innerhalb der Garantiezeit werden alle Mängel, die auf Material- oder Herstellungsfehler zurückzuführen sind, kostenlos beseitigt. Der Garantieanspruch erlischt bei Eingriffen durch den Käufer oder durch Dritte. Schäden, die durch unsachgemäße Behandlung oder Bedienung, durch falsches Aufstellen oder Aufbewahren, durch unsachgemäßen Anschluss oder Installation sowie durch höhere Gewalt oder sonstige äußere Einflüsse entstehen, fallen nicht unter die Garantieleistung. Wir behalten uns vor, bei Reklamationen die defekten Teile auszubessern, zu ersetzen oder das Gerät auszutauschen. Ausgetauschte Teile oder ausgetauschte Geräte gehen in unser Eigentum über. Schadenersatzansprüche sind ausgeschlossen, soweit sie nicht auf Vorsatz oder grober Fahrlässigkeit des Herstellers beruhen.

Sollte Ihr Gerät dennoch einen Defekt innerhalb der Garantiezeit aufweisen, wenden Sie sich bitte unter Vorlage Ihrer Kaufquittung ausschließlich an das Geschäft, in dem Sie Ihr SWITEL - Gerät gekauft haben. Alle Gewährleistungsansprüche nach diesen Bestimmungen sind ausschließlich gegenüber Ihrem Fachhändler geltend zu machen. Nach Ablauf von zwei Jahren nach Kauf und Übergabe unserer Produkte können Gewährleistungsrechte nicht mehr geltend gemacht werden.

15 Stichwortverzeichnis

A

- Abmelden von Mobilteilen, 36
- Akkuladezustand, 7
- Akkus aufladen, 7
- Akkus einlegen, 7
- Alle Nachrichten / Memos löschen, 21
- Amtskennziffer, 24
- Anmelden von Mobilteilen, 36
- Anruf annehmen, 13
- Anruf übernehmen, 18
- Anrufbeantworter, 17
- Anrufbeantworter ein- / ausschalten, 17
- Anrufbeantworter im Telefonnetz, 25
- Anrufen, 13
- Ansagemodus wählen, 19
- Ansagen aufzeichnen, 19
- Ansagen löschen, 19
- Anzahl Tonrufe einstellen, 18
- Automatische Gesprächsannahme, 32

B

- Basisstation anschließen, 6
- Bedienelemente, 8
- Besondere Funktionen, 32

D

- Darstellungen, 9
- Dimm-Modus, 27, 33
- Direktannahme, 32
- Direktruf, 32

E

- Eingegangene Anrufe zurückerufen, 13
- Erweitern des Telefonsystems, 36
- Externe Gespräche intern weiterleiten, 14

F

- Falls es Probleme gibt, 37
- Fehlerbehebung, 37
- Fernabfrage, 22
- Ferneinschalten des Anrufbeantworters, 23
- Flash-Zeit, 29
- Fragen und Antworten, 37
- Freisprechen, 16

G

- Garantie, 41
- Gespräch beenden, 13
- Gesprächsdauer, 15

H

- Hauptmenü, 26
- Hörerlautstärke, 15

I

- Impulswahl, 29
- Intern Telefonieren, 14
- Interne Gespräche führen, 14

K

- Konferenzgespräche führen, 15
- Konformitätserklärung, 40

L

- Lautstärke des Anrufbeantworters einstellen, 18

M

- Makeln, 15
- Maximale Aufnahmezeit, 17
- Mehrere Basisstationen, 36
- Mehrere Mobilteile, 36
- Memo aufzeichnen, 20
- Memos abhören, 20
- Memos löschen, 20
- Menüstruktur, 26
- Mikrofon stummschalten, 16
- Mithören eingehender Nachrichten, 18
- Mobilteil aus- und einschalten, 16
- Mobilteil suchen, 16

N

- Nachrichten abhören, 20
- Nachrichten löschen, 20
- Navigationstasten, 11
- Nebenstellenanlagen, 24
- Notrufnummern, 33
- Nummern verketten und übertragen, 14
- Nur-Ansage, 19

P

- Paging, 16
- Pflegehinweise, 41

R

- R-Taste an Nebenstellenanlagen, 24
- R-Taste und Zusatzdienste, 24
- Rücksprache, 15
- Rufnummern aus dem Telefonbuch wählen, 13
- Rufnummernanzeige, 25

S

- Schreibweisen, 9
- Sicherheitscode Fernabfrage, 22
- Sicherheitshinweise, 4
- SMS Alarm, 35
- SMS Hinweissignal, 35
- SMS Service Center, 34
- SMS Voraussetzungen, 34
- Spar-Modus, 18
- Symbole im Display, 9

T

- Tastenfunktionen der Fernabfrage, 23
- Tastensperre, 16
- Technische Daten, 39
- Telefon in Betrieb nehmen, 6
- Telefonbuch, 31
- Telefonbucheinträge erstellen, 12
- Telefonieren, 13
- Temporäre Tonwahl, 32
- Text eingeben, 35
- Tonrufmelodie, 16
- Tonwahl (DTMF), 29

V

- Verpackungsinhalt, 6
- Verzögerung, 18
- VMWI, 25

W

- Wahlpause automatisch, 24
- Wahlpause manuell eingeben, 24
- Wahlverfahren, 29, 32
- Wahlwiederholung, 13
- Werkseinstellungen, 39
- Wie bediene ich mein Telefon?, 9
- Wochentag und Uhrzeit des Anrufbeantworters einstellen, 17

Z

- Zusatzdienste, 24

Table des matières

1	Consignes de sécurité	45
2	Mettre le téléphone en service	47
3	Éléments de manipulation	49
4	Comment me servir du téléphone	50
5	Téléphoner	54
6	Répondeur	58
7	Installations à postes suppl. / Services suppl.	65
8	Structure du menu	67
9	Fonctions spéciales	73
10	SMS	75
11	Élargissement du système téléphonique	77
12	En cas de problèmes	78
13	Caractéristiques techniques	80
14	Remarques d'entretien / Garantie	82
15	Index	83

1 Consignes de sécurité

Lisez très attentivement ce mode d'emploi.

Utilisation conforme aux prescriptions

Ce téléphone convient pour téléphoner à l'intérieur d'un réseau téléphonique. Toute autre utilisation est considérée comme non conforme à l'usage. Des modifications ou changements effectués d'un propre gré ne sont pas autorisés. N'ouvrez en aucun cas l'appareil et n'effectuez aucun essai de réparation vous-même.

Lieu d'installation

Évitez toute nuisance par la fumée, la poussière, les tremblements, les produits chimiques, l'humidité, la grande chaleur ou l'ensoleillement direct.

N'utilisez pas le combiné dans des zones exposées aux explosions.

Bloc secteur



Attention : N'utilisez que le bloc d'alimentation fourni avec l'appareil, d'autres pouvant détruire votre téléphone. Vous ne devez pas bloquer son accès par des meubles ou autres objets.

Piles rechargeables



Attention : Ne jetez pas les piles dans le feu ou ne les plongez pas dans l'eau.

Panne de courant

En cas de panne de courant, vous ne pouvez pas téléphoner avec cet appareil. Pour les cas d'urgence, ayez à votre disposition un téléphone à fil fonctionnant sans alimentation externe en courant.

Appareils médicaux



Attention : N'utilisez pas le téléphone à proximité d'appareils médicaux. Une influence ne peut pas être totalement exclue.

DECT¹- Les téléphones DECT peuvent causer un bourdonnement désagréable dans les prothèses auditives.

¹ **DECT:** Digitally Enhanced Cordless Telecommunication = Standard pour téléphones sans fil.

Consignes de sécurité

Élimination

Si votre appareil ne sert plus, veuillez l'apporter au centre de collecte de l'organisme d'élimination des déchets de votre commune (par ex. centre de recyclage). Le symbole ci-après signifie que l'appareil usagé ne doit pas être éliminé avec les ordures ménagères, mais séparément.



D'après la loi relative aux appareils électriques et électroniques, les propriétaires d'appareils usagés sont tenus de mettre tous les **appareils électriques et électroniques** usagés dans un collecteur séparé.

Éliminez les piles auprès d'un revendeur spécialisé ainsi que dans des centres de collecte qui tiennent à votre disposition les collecteurs appropriés correspondants. **Les fournitures d'emballage** sont à éliminer conformément au règlement local.



Mettre le téléphone en service

2 Mettre le téléphone en service

Remarques concernant la sécurité



Attention : Avant de mettre votre appareil en service, lisez impérativement les consignes de sécurité mentionnées au chapitre 1.

Vérifier le contenu de l'emballage

Les éléments suivants font partie de la livraison :

- une base avec bloc d'alimentation
- un câble de raccordement téléphonique
- un combiné
- deux piles rechargeables
- un mode d'emploi

Raccordement de la base



Attention : Posez la base à une distance minimum d'un mètre par rapport aux autres appareils électroniques pour éviter d'éventuelles interactions.

Raccordez la base tel que décrit sur le croquis. Pour des raisons de sécurité, n'utilisez que le bloc d'alimentation (6V, 600mA) fourni avec l'appareil ainsi que le câble de raccordement téléphonique ci-joint.

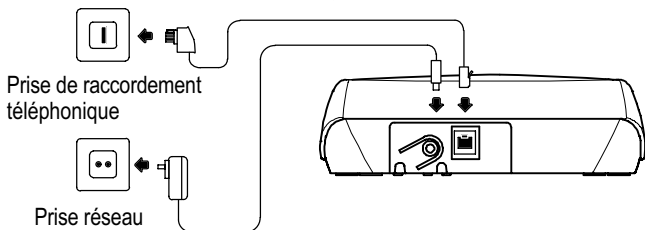

Mettre le téléphone en service

Pose des piles rechargeables

Introduisez les piles dans le compartiment prévu à cet effet. N'utilisez que des piles rechargeables de type AAA Ni-MH 1,2 V. Observez une polarisation correcte ! Fermez le compartiment à piles.

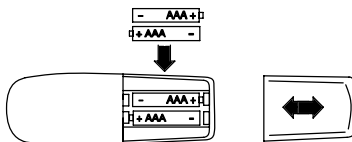

Chargement des piles rechargeables

Lors de la première mise en service, placez le combiné pendant au moins 16 heures sur sa base. Si vous l'avez correctement placé sur sa base, un signal indicateur se fait entendre. Le combiné chauffe lors du chargement. C'est normal et inoffensif. Ne chargez pas le combiné avec des chargeurs d'un autre fabricant. Le niveau actuel **de chargement des piles** est affiché sur l'écran :



Plein



Moyen



Faible



Vide

Régler l'heure et la date de votre combiné

Vous réglez la date et l'heure via le menu. La page 70 vous donnera la position dans le menu.

Installations à postes supplémentaires

La page 65 vous donnera de plus amples informations au cas où vous désiriez raccorder votre téléphone à une installation à postes supplémentaires.

Réglage du jour de la semaine et de l'heure du répondeur

Le jour de la semaine ainsi que l'heure de votre répondeur sont automatiquement réglés via le combiné.

3 Éléments de manipulation

Combiné

- 1 Vers le haut / Liste d'appels
- 2 Touche softkey droite
- 3 Répertoire
- 4 Touche R (Flash)
- 5 Vers le bas
- 6 Raccrocher / Combiné marche/arrêt
- 7 Touche dièse / Verrouillage du clavier
- 8 Désactiver la sonnerie / Numérotation par tonalité temporaire
- 9 Décrocher
- 10 Mode mains-libres
- 11 Retour / Mettre le microphone sur silencieux
- 12 Touche softkey gauche
- 13 Touche de menu "Info"

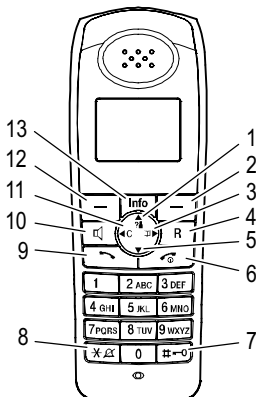

Base (répondeur)

- 1 Chercher un combiné (paging)
- 2 Répondeur Marche / Arrêt
- 3 DEL affichage de communications
- 4 Sauter en arrière
- 5 Effacer
- 6 Écoute / Stop
- 7 DEL voyant de charge
- 8 Sauter en avant
- 9 Volume sonore +
- 10 Volume sonore -

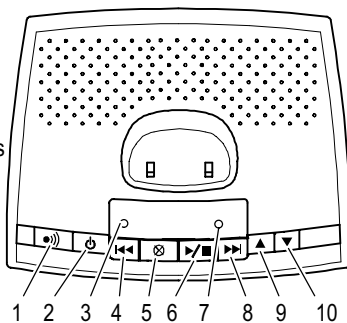











Les touches sont représentées dans ce mode d'emploi par un contour uniforme. Les symboles de votre téléphone peuvent présenter des différences par rapport à ceux représentés ici.







Comment me servir du téléphone

4 Comment me servir du téléphone















Représentations et notations

	Saisir des chiffres ou des lettres
	Appuyer brièvement sur la touche représentée
2 sec 	Appuyer 2 secondes sur la touche représentée
	Le combiné sonne
	La base sonne
	Retirer le combiné de la base
	Poser le combiné sur la base
 Deutsch ou 	Texte ou icônes sur l'écran
	Appuyer sur la touche softkey  page 52

Symboles à l'écran

Ecran	Description
	Permanent : La liaison avec la base est bonne. Signaux sonores d'avertissement: La communication est interrompue. Supprimé de l'écran: La communication est interrompue. Rapprochez-vous de la base.
	Le mode mains-libres est activé.  page 57
	Permanent : Vous téléphonez. Clignotant : Le téléphone sonne.  page 54
	La sonnerie d'appel est désactivée.  page 57

Comment me servir du téléphone

Ecran	Description
	Le microphone est réglé sur silencieux.  page 57
 et Verrouillage	Le verrouillage du clavier est activé.  page 57
	Permanent : Affichage de la capacité des piles. Continu: Les piles rechargeables sont en train d'être chargées.  page 48
DFT727	Nom du combiné  page 77
1	Numéro d'appel interne du combiné  page 77
01.12 13:26	Affichage de la date et de l'heure  page 70
 et Nouveaux appels	Nouveaux appels dans la liste d'appels.  page 72 et 66 De plus, une DEL rouge clignote derrière la Info Info.
 et Nouveau SMS	Vous avez un nouveau SMS ¹ .  page 67 et 75
	Répondeur dans le réseau téléphonique. VMWI ² - Service optionnel de votre opérateur  page 66

¹ **SMS** : Short Message Service

² **VMWI** : Visual Message Waiting Indication

Comment me servir du téléphone

Touches de navigation

Toutes les descriptions de ce mode d'emploi partent du principe que le combiné se trouve en mode d'attente. Vous obtenez ce mode en appuyant sur la touche



Les touches softkey (1) et (7) sont occupées par différentes fonctions dans les différents menus. Dans ce mode d'emploi, elles sont toujours dénommées selon les textes inscrits ci-dessus à l'écran.

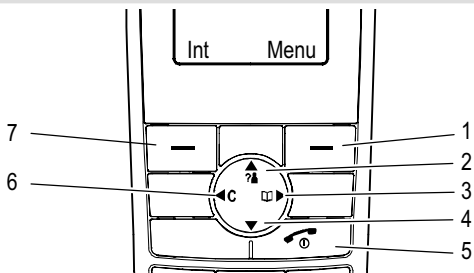













Touche	En mode de veille	Dans le menu
1	- ouvre le menu principal	- ouvre le menu affiché
2	- ouvre la liste d'appels	- se déplacer vers le haut - modifier les paramètres
3	- ouvre le répertoire	- se déplacer vers la droite
4		- se déplacer vers le bas - modifier les paramètres
5	- brancher, débrancher le combiné	- interrompre les opérations de programmation et de sauvegarde
6		- se déplacer vers la gauche - reculer d'une position
7	- communications internes	- reculer d'une position

Comment me servir du téléphone

Navigation dans le menu





Vous pouvez accéder à toutes les fonctions via différents menus. La structure du menu vous indique le chemin à prendre jusqu'à la fonction désirée.  page 67

Menu	Ouvrir le menu principal
 ou  ,  ou 	sélectionner le sous-menu désiré
OK	Ouvrir le sous-menu
 ou 	Sélectionner la fonction désirée
OK	Ouvrir la fonction
 ou 	Sélectionner le réglage désiré
	Saisir des chiffres ou des lettres via le pavé numérique.
OK ou Enreg	Confirmer les saisies ou enregistrer
 ou <<	Reculer d'une position
	Interrompre les opérations de programmation et de sauvegarde et retourner en mode de veille

 Chaque opération est automatiquement interrompue si vous n'effectuez pas de saisie dans les 30 secondes.

Créer des enregistrements dans le répertoire- Exemple

L'exemple **Créer des enregistrements dans le répertoire** vous explique comment naviguer dans les menus et effectuer des entrées. Pour tous les réglages, procédez comme dans cet exemple.

	Ouvrir le répertoire
Opt	Ouvrir le menu options
 ou 	
Nouvelle entrée	Sélectionner la fonction et confirmer
Numéro:  OK	Entrer le numéro d'appel (max. 24 chiffres) et confirmer
Nom:  Enreg	Entrer le nom (max. 15 lettres) et enregistrer

F

Téléphoner

5 Téléphoner

Prendre l'appel



Prendre l'appel

Terminer la communication

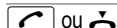

Terminer la communication

Appeler



Composer le numéro d'appel (max. 24 chiffres)

Eff

Si la saisie est erronée, effacer le dernier chiffre



Composer le numéro

 Vous pouvez également appuyer pendant 2 secondes sur la touche de communication et vous obtenez ainsi la tonalité. Les chiffres saisis de votre numéro d'appel seront immédiatement composés. La correction individuelle des chiffres du numéro d'appel n'est pas possible quand la communication est établie de cette manière.

Touche de répétition automatique des derniers numéros

Votre téléphone enregistre les 20 derniers numéros composés dans une liste de répétition automatique des derniers numéros.



Ouvrir la liste de répétition automatique des derniers numéros



Sélectionner l'enregistrement et confirmer

Rappel des appels entrés

Votre téléphone enregistre les 30 appels manqués dans une liste d'appels.



Ouvrir la liste d'appels



Sélectionner l'enregistrement et confirmer

F Composition de numéros du répertoire

Vous devez avoir enregistré des numéros d'appel dans le répertoire.

 page 53 et 72



Ouvrir le répertoire



Sélectionner l'enregistrement et confirmer

Enchaînement et transmission de numéros

La fonction de numérotation en chaîne est employée dans le cas de services de télécommunication plus complexes comme par ex. la banque par téléphone, l'appel par appel ou l'emploi de la carte pastel. Vous pouvez transférer les uns après les autres de votre répertoire plusieurs numéros enregistrés. Vous pouvez combiner des transmissions de numéros de votre répertoire avec des entrées de numéros à la main. Pendant une communication, vous pouvez numérotter en chaîne autant d'enregistrements de votre répertoire que vous désirez et les transférer.



Ouvrir le répertoire

ou , **OK**

Sélectionner l'enregistrement du répertoire et transférer le numéro

Téléphoner en interne

Téléphoner en interne

Vous devez avoir déclaré deux ou plusieurs combinés (MT1, MT2, ...) sur votre base afin de pouvoir téléphoner en interne gratuitement. Autres informations page 77

MT1: **Int**, ou

z. B. **Combiné 2**, **OK**

Composer des numéros du combiné désiré

MT2:

Prendre la communication en interne sur l'autre combiné

MT1 / MT2:

Terminer la communication interne

Transférer des communications externes à des internes

MT1: **Int**, ou

z. B. **Combiné 2**, **OK**

Composer des numéros internes pendant la communication externe.

MT2:

Prendre la communication en interne sur l'autre combiné

MT1:

Transférer la communication



Si le combiné ne prend pas l'appel, vous pouvez reprendre l'appel externe en appuyant sur la touche .

Téléphoner

Intercommunication / Va-et-vient

Vous pouvez, pendant une communication externe, sélectionner un autre combiné pour intercommuniquer. Le correspondant externe est maintenu en ligne pendant que vous parlez avec le correspondant interne. Vous pouvez changer de correspondant autant de fois que vous le désirez.

MT1: , ou

z. B. ,

Composer des numéros internes pendant la communication externe.

MT2:

Prendre la communication en interne sur l'autre combiné

MT1:

Changer de correspondant

Mener des conférences téléphoniques

Une communication externe peut être branchée sur un autre correspondant interne dans le but de mener une conférence.

MT1: , ou

z. B. ,

Composer des numéros internes pendant la communication externe.

MT2:

Prendre la communication en interne sur l'autre combiné

MT1:

Commencer la conférence



À cet endroit, vous pouvez passer d'un correspondant à un autre et re-commuter sur la conférence.

MT1 / MT2:

La conférence se termine quand un correspondant interne raccroche

Régler le volume sonore de l'écouteur

Vous disposez de 5 niveaux pour régler le volume pendant une communication.

ou

Sélectionner le volume sonore désiré



F

Affichage de la durée de la communication

Pendant une communication, sa durée est affichée en heures, minutes et secondes.



Mode mains-libres

Utilisez cette fonction pour entendre le correspondant par l'intermédiaire du haut-parleur.

	Activer le mode mains-libres
	Débrancher le mode mains-libres

Débranchement du microphone du combiné

Pendant une communication, vous pouvez activer et désactiver le microphone du combiné.

	Désactiver le microphone (mettre sur silencieux)
	Activer le microphone

Verrouillage du clavier

3 sec 	Activer le verrouillage du clavier
---	------------------------------------



Lorsque le verrouillage du clavier est activé, vous pouvez comme d'habitude réceptionner des appels entrants.

3 sec 	Désactiver le verrouillage du clavier
---	---------------------------------------

Mélodie de sonnerie d'appel du combiné

Vous pouvez désactiver la mélodie de sonnerie d'appel du combiné.

3 sec 	Désactiver la mélodie de sonnerie d'appel
---	---







Le réglage de la sonnerie d'appel sur la base reste inchangé.

3 sec 	Activer la mélodie de sonnerie d'appel
---	--





Chercher le combiné (Paging)

Si vous avez perdu votre combiné, vous pouvez le retrouver facilement grâce à un son de recherche.

 	Démarrer le son de recherche
 ou 	Terminer le son de recherche

Branchement et débranchement du combiné

Vous pouvez débrancher le combiné pour épargner les piles rechargeables.

2 sec  Déconnect. comb?	
 ou 	Confirmer ou annuler
2 sec 	Brancher le combiné

Répondeur

6 Répondeur

Vous pouvez commander toutes les fonctions de votre répondeur (AB) via votre combiné. Certaines fonctions vous sont disponibles en supplément directement sur la base.



Votre répondeur dispose d'un guide parlé de l'utilisateur. Tenez compte de ces instructions et remarques.

Vous parvenez ainsi au menu de réglage du répondeur :

Menu	Ouvrir le menu principal
◀ ou ▶	
Répondeur	, OK Ouvrir menu répondeur (AB)
◀ ou ▶	
Paramètres rép.	, OK Ouvrir le menu de réglage

Réglage du jour de la semaine et de l'heure

A l'écoute des messages, le jour de la semaine et l'heure de leur entrée seront indiqués à chaque message. Le jour de la semaine ainsi que l'heure de votre répondeur sont automatiquement réglés via le combiné ☎ page 70.

Branchement / débranchement du répondeur

Sur la base :

⏻	Branchement / débranchement du répondeur
---	--

Via le combiné dans le menu AB:

▲ ou ▼	
Répondeur On/Off	, OK Sélectionner la fonction et confirmer
▲ ou ▼ Désactivé	ou
Activé	, OK Sélectionner le réglage et confirmer

Durée d'enregistrement maximale

Le répondeur enregistre jusqu'à 99 messages. La durée d'enregistrement maximum est de 15 minutes. Si la capacité de la mémoire est saturée et ne peut plus recevoir de nouveaux messages, plus aucun appel ne sera enregistré.

Régler le volume sonore

Vous pouvez régler le volume du guide de l'utilisateur en 6 sensibilités.

Sur la base :

ou régler le volume

Sur le combiné :

ou régler le volume

Régler le nombre des sonneries d'appel (Temporisation)

Vous pouvez choisir entre 2 et 8 sonneries d'appel et le réglage **Mode économique** pour la consultation préalable à distance exonérée de taxe.

La consultation préalable à distance gratuite vous permet de constater si vous avez de nouveaux messages sur votre répondeur.

- S'il y a de nouveaux messages sur votre répondeur, votre appel sera pris dès la 2 sonnerie.
- Si aucun message n'a été enregistré, votre appel ne sera pris qu'au bout de la 6sonnerie. Raccrochez avant la 6 sonnerie. Vous n'aurez ainsi pas de frais à payer.

Dans le menu de réglage:

ou

Délai avant rép. , Sélectionner la fonction et confirmer

ou par ex. :

Mode économique , Sélectionner le réglage et confirmer

Autres informations relatives à la consultation à distance  page 63

Ecoute amplifiée de messages entrants

Vous pouvez, par l'écoute amplifiée, entendre les appels entrants sans pour autant répondre à l'appel.

Activer l'écoute amplifiée

Désactiver l'écoute amplifiée

Prise d'appel

Si le répondeur a déjà répondu à un appel, vous pouvez reprendre celui-ci. L'enregistrement du message est, dans ce cas, interrompu.

Prendre l'appel

Répondeur

Sélectionner le mode des annonces

Votre répondeur met à votre disposition deux textes d'annonce préenregistrés. Après le "texte d'annonce avec enregistrement", vous pouvez laisser un message. Pour le "texte d'annonce sans enregistrement" il s'agit d'une **Simple annonce** après laquelle vous ne pouvez pas laisser de message. Vous pouvez remplacer les textes d'annonce par vos propres textes. Si la mémoire du répondeur est pleine, c'est la simple annonce qui se fera automatiquement entendre.

Dans le menu de réglage:

▲ ou ▼

Mode répondeur , OK Sélectionner la fonction et confirmer

▲ ou ▼ Répond-Enregist

ou Répondeur seul , OK Sélectionner le réglage et confirmer

Enregistrement / contrôle et suppression des annonces

Enregistrement des annonces

La longueur de la propre annonce peut être de 2 minutes.

Dans le menu de réglage:

▲ ou ▼

Annonce accueil , OK Ouvrir menu annonces

▲ ou ▼

Enreg. annonce , OK Sélectionner la fonction et confirmer

▲ ou ▼ Répond-Enregist

ou Répondeur seul , OK Sélectionner l'annonce et confirmer

📞 , Enreg Parler l'annonce et enregistrer

Contrôle de l'annonce actuellement enregistrée

Dans le menu annonces:

▲ ou ▼

Écouter annonce , OK Sélectionner la fonction et confirmer



▲ ou ▼ Répond-Enregist

ou Répondeur seul , OK Sélectionner l'annonce et confirmer

Suppression d'une annonce personnelle et retour à l'annonce standard

Si vous effacez votre annonce personnelle, c'est l'annonce standard préenregistrée qui sera automatiquement activée.

Dans le menu annonces:



 ou 	
<input type="text" value="Écouter annonce"/> , <input type="button" value="OK"/>	Sélectionner la fonction et confirmer
<input type="button" value="Eff"/>	Effacer pendant l'enregistrement

Enregistrement d'un mémo

Un mémo est une information qui peut être écoutée comme un message entré.

Enregistrement d'un mémo

Dans le menu AB:





 ou 	
<input type="text" value="Enregistrer mémo"/> , <input type="button" value="OK"/>	Sélectionner la fonction et confirmer
 , <input type="button" value="Enreg"/>	Parler le mémo et enregistrer

Messages enregistrés / Écouter les mémos ou les effacer

Ecoute des messages

Les messages / mémos enregistrés sont restitués dans l'ordre dans lequel ils sont entrés. Le jour de la semaine et l'heure sont nommés avant l'écoute du message ou du mémo.

Sur la base :

	Diffusion
	Arrêter l'a diffusion
	Répéter un message
2 x 	Ecouter le message précédent
	Prochain message

Via le combiné dans le menu AB:

 ou 	
<input type="text" value="Écouter messages"/> , <input type="button" value="OK"/>	Ouvrir le menu messages

Commande supplémentaire  Fonctions des touches dans le menu messages

Répondeur

Suppression d'un message

Sur la base :

 Écouter le message à effacer

 Effacer un message

Via le combiné dans le menu AB:







 ou 

Écouter messages ,  Ouvrir le menu messages

 Effacer le message en cours

Commande supplémentaire  Fonctions des touches dans le menu messages

Fonctions des touches dans le menu des messages

Touche	Fonctions
	Écoute / Stop
 , 	Ecoute du message précédent
	Effacer le message en cours
 , 	Ecoute du message suivant

Suppression de tous les messages / mémos

Tous les messages / mémos sont effacés. Les nouveaux messages / mémos sont conservés.

Sur la base :

2 sec  Démarrer l'effacement

 Confirmer l'effacement

Via le combiné dans le menu AB:

 ou 

Eff. tous mess. ,  Sélectionner la fonction et confirmer

Effacé?  Confirmer l'effacement
ou

Effacé?  Annuler l'effacement

La consultation à distance

Vous pouvez appeler votre répondeur pour écouter les messages et utiliser d'autres fonctions. Pour cela, vous devez posséder un téléphone avec la fonctionnalité numérotation par tonalité.

Le code de sécurité pour la consultation à distance

Le code de sécurité est réglé à l'usine sur "0000". Afin de pouvoir effectuer une consultation à distance, vous devez modifier le code de sécurité "0000" réglé en usine. Vous ne pouvez effectuer une consultation à distance que si le code de sécurité n'est pas réglé sur "0000".

Modifier le code de sécurité

Dans le menu de réglage:

<input type="button" value="▲"/> ou <input type="button" value="▼"/>	
Mod.PIN distance	, <input type="button" value="OK"/> Sélectionner la fonction et confirmer
Ancien PIN: <input type="text"/>	<input type="button" value="OK"/> Entrer l'ancien code de sécurité
Nouveau PIN: <input type="text"/>	<input type="button" value="OK"/> Saisir le nouveau code de sécurité
Répéter PIN: <input type="text"/>	<input type="button" value="OK"/> Répéter le nouveau code de sécurité

Démarrer la consultation à distance

<input type="button" value="☎"/>	Composer le numéro d'appel personnel
<input type="button" value="#"/> , <input type="button" value="☎"/>	Confirmer pendant l'annonce et entrer le code de sécurité



En cas de saisie erronée, écoutez à nouveau l'annonce du répondeur. Si le code de sécurité a été saisi trois fois de manière erronée, la ligne sera automatiquement coupée.

Maintenant, vous avez la possibilité d'effectuer d'autres fonctions.  Tableau des fonctions des touches de la consultation à distance

Répondeur

Branchement à distance du répondeur



Composer le numéro d'appel personnel



Si vous avez oublié de brancher votre répondeur, votre appel ne sera réceptionné qu'au bout de 10 sonneries.

#,

Confirmer pendant l'annonce et entrer le code de sécurité

0

Brancher / débrancher le répondeur

Maintenant, vous avez la possibilité d'effectuer d'autres fonctions. Tableau des fonctions des touches de la consultation à distance

Fonctions des touches de la consultation à distance



La consultation à distance est automatiquement interrompue si vous n'effectuez pas de saisie dans les 8 secondes.

Le tableau suivant vous donne une vue d'ensemble des fonctions de chaque touche.

Touche	Fonctions
1	Ecouter le menu d'aide
2	Démarrer l'écoute de tous les messages
3	Démarrer l'écoute des nouveaux messages
4	Écouter un message en cours
2 x 4	Ecouter le message précédent
5	Effacer le message en cours
6	Ecouter le message suivant
7	Sélectionner le mode d'annonce : "Texte d'annonce avec enregistrement" ou "Texte d'annonce sans enregistrement"
8	Ecouter le texte d'annonce actuellement paramétré
9	Enregistrer le texte d'annonce actuellement paramétré
0	Brancher / débrancher le répondeur
#	Terminer l'enregistrement du texte d'annonce
	Raccrocher pour terminer la consultation à distance.

Installations à postes suppl. / Services suppl.

7 Installations à postes suppl. / Services suppl.

Touche R sur les installations à postes supplémentaires

Si votre téléphone est raccordé à une installation à postes supplémentaires, vous pouvez, par l'intermédiaire de la touche **R**, tirer profit des fonctions comme par ex. le transfert d'appels et le rappel automatique. Veuillez lire dans le mode d'emploi de votre installation à postes supplémentaires quel temps de flash vous devez régler pour l'utilisation de ces fonctions. Votre revendeur, auprès duquel vous avez acheté l'installation, vous informera si votre téléphone fonctionne parfaitement sur ce genre d'installation. Réglage du temps de flash  Page 70.

Chiffre de la ligne principale

Avec les installations à postes supplémentaires, vous devez composer un numéro déterminé pour obtenir une tonalité de la ligne principale. Vous pouvez enregistrer le chiffre de la ligne principale. Si votre téléphone reconnaît ce chiffre de la ligne principale avant un numéro entré, **une pause sera automatiquement** introduite après le chiffre de la ligne principale. Réglage du chiffre de la ligne principale  page 70

Entrer manuellement la pause de numérotation

Après le chiffre de la ligne principale, vous pouvez **manuellement** insérer une **pause de numérotation** afin de pouvoir continuer à composer un numéro dans avoir besoin d'attendre la tonalité.

2 sec

Insérer une pause de numérotation

Après le chiffre de la ligne principale, votre téléphone attend 3 secondes avant de composer le numéro d'appel.



La pause peut également être enregistrée lors de la saisie de numéros d'appel dans le répertoire.

Touche R et services supplémentaires

Votre téléphone supporte des services supplémentaires de votre opérateur, comme par ex. le va-et-vient, la signalisation d'appel en instance et la conférence. Vous pouvez utiliser ces services supplémentaires par l'intermédiaire de la **touche R**. Demandez à votre opérateur quel temps de flash vous devez régler pour utiliser ces services supplémentaires. Contactez votre opérateur pour déconnecter les services supplémentaires. Réglage du temps de flash  Page 70.

Installations à postes suppl. / Services suppl.

Répondeur dans le réseau téléphonique

Si votre opérateur met à votre disposition un répondeur dans le réseau téléphonique, un icône représentant une boîte aux lettres (**VMWI**¹) vous informera des nouveaux messages. Le répondeur et l'information vous indiquant l'arrivée de nouveaux message par un symbole sont des services optionnels de sa part. Vous ne pouvez disposer de ces fonctions que si ce dernier supporte ce service. Veuillez lui demander de plus amples informations.

Affichage du numéro d'appel (CLIP²)



L'affichage du numéro d'appel est un service optionnel de votre opérateur. Veuillez lui demander de plus amples informations.

Si cette fonction est à votre disposition sur votre ligne téléphonique, le numéro du correspondant vous sera affiché dès que le téléphone sonne. Cependant, le numéro ne peut être affiché et enregistré dans la liste d'appels si le correspondant a bloqué la transmission de son numéro. Un message correspondant sur l'écran vous en informe.

¹ **VMWI** : Visual Message Waiting Indication

² **CLIP** : Calling Line Identification Presentation

8 Structure du menu

Menu principal

Vous accédez au menu principal en appuyant sur la touche softkey **Menu**. Le chapitre 4 vous indique comment vous déplacez dans le menu et effectuez des entrées.

SMS¹

Écrire nouv. SMS				Texte:	Numéro:	Envoi SMS	
						Enregistrer SMS	
						Effacer SMS	
Entrant	Enregist. 1	Opt	Répondre à SMS		Utiliser texte?		
		Enregist. 2	Effacer SMS				
		Enregist. ...	Numéro d'appel				
				Enreg. dans rép.	Nom:		
Envoyé	Enregist. 1	Opt	Envoi SMS		Numéro:		
		Enregist. 2	Éditer SMS				
		Enregist. ...	Effacer SMS				
Paramètres SMS	Serveur SMS		Serveur SMS 1 - 4		Numéro:		
		Sél. serv.envoi	Serveur SMS 1 - 4				
		Alerte SMS	Désactivé				
				Activé			

¹ D'autres informations relatives aux messages écrits SMS ☞ page 75.

Structure du menu

Info	Avec la touche Info, vous accédez directement dans ce menu.		
Entrant	Répondeur (-)	(uniquement lors de nouveaux messages)	
	Liste d'app. (-)	(uniquement lors de nouveaux appels)	
	SMS (-)	(uniquement lors de nouveaux SMS)	
SMS	☞ Page 67		
Liste d'app.	☞ Page 72		
Rép. partagé	Enregist. 1	Opt	Éditer entrée Numéro: Nom:
	Enregist. ...		Effacer entrée Effacé?

Écran

Fond d'écran	Fond d'écran 1	(Fond d'écran en veille)
	Fond d'écran 2	
	Fond d'écran 3	
	Fond d'écran 4	
	Fond d'écran Désactivé	
Nom combiné	Nom:	
Contraste écran	Volume 1 - 8	
Écran couleur	Bleu / Rose	
	Vert / Jaune	
	Rouge / Brun	
Rétroécl. On/Off	Désactivé	(Éclairage du clavier)
	Activé	
Mode variateur	Éteint	(Vous trouverez d'autres informations sur le "Menu Variateur" à la
	Toujours allumé	☞ page 74)
	Pour 10 min	

Structure du menu

Sons

Sonnerie	Vol. sonnerie	Désactivé
		Vol. sonnerie 1 - 5
		Vol. sonnerie ^ 1
Bips alerte	Mélodie sonn	Mélodie sonn 1 - 15
	Bips touche	Désactivé
	Accu faible	Activé
		Désactivé
Hors portée		Activé
		Désactivé
		Activé

Paramètres

Sélection comb.	Appel direct	Entrer PIN: 2
	Appel direct On	Numéro:
	Appel direct Off	
	Sélection base	Base A
		Base ...
	Rép.auto. On/Off	Désactivé
		Activé
	No. d'urgence	
	No. d'urgence 1	Numéro:
	No. d'urgence ...	
	Remise à zéro	Remise à zéro?
	Langue	Deutsch
		Français / Italiano

¹ Avec ce réglage, le volume augmente avec chaque sonnerie.

² Le code PIN est réglé en usine sur "0000".

Structure du menu

↙			
Sélection base	Sonnerie	Vol. sonnerie	Désactivé
			Vol. sonnerie 1 -5
		Mélodie sonn	Mélodie sonn 1 - 5
	Mode numérotat.	Fréquence voc.	
		Impulsions	
	Indicatif réseau	Numéro:	
	Modifier PIN ¹	Ancien PIN:	Nouveau PIN: ▶
		▶	Répétez PIN:
	Remise à zéro	Remise à zéro?	Entrer PIN: ▶
		▶	Veuillez attend
Date/Heure	Date:	Temps:	
Temps Flash	Flash 1 - 8		
Déclarer combiné	Base A * ²	Entrer PIN:	Recherche comb.!
	Base B		
	Base C		
	Base D		
Supprim. combiné	Entrer PIN:	Combiné 1	Déconn. combiné?
		Combiné ...	

¹ Le code PIN est réglé en usine sur "0000".

² Lorsque vous déclarez des bases, 4 places de mémoire sont à votre disposition. Les places de mémoire marquées par une étoile ont déjà été occupées. Si vous utilisez une place de mémoire pour vous déclarer, l'ancien enregistrement est écrasé sur cette place.

Structure du menu

Répondeur¹

Écouter messages		
Eff. tous mess.	Effacé?	
Répondeur On/Off	Désactivé	
	Activé	
Paramètres rép.	Mode répondeur	Répond-Enregist
		Répondeur seul
	Annonce accueil	Enreg. annonce Répond-Enregist
		Répondeur seul
	Écouter annonce	Répond-Enregist
		Répondeur seul
	Longueur message	30 / 60 / 120 s
		Long. illimitée
	Délai avant rép.	Mode économique
		2 sonneries
		4 sonneries
		6 sonneries
		8 sonneries
	Mod.PIN distance	Ancien PIN: Nouveau PIN: ▶
		▶ Répéter PIN:
Enregistrer mémo		

¹ Vous trouverez d'autres informations sur le répondeur ☞ page 58.

Structure du menu

Répertoire

Vous accédez au répertoire en appuyant sur la touche .

Répertoire

Enregist. 1	Opt	Nouvelle entrée	Numéro:	Nom: ¹
Enregist. 2		Éditer entrée	Numéro:	Nom: ¹
Enregist. ...		Effacer entrée	Effacé?	
		Effacer toutes	Effacé?	

Liste d'appels

Vous accédez à la liste d'appels en appuyant sur la touche .

Liste d'app. ²

Enregist. 1	Opt	Effacer entrée	Effacé?
Enregist. 2		Effacer listes	Effacé?
Enregist. ...		Détails	
		Enreg. dans rép.	Nom: ¹

¹ Des lettres sont inscrites sur les touches de chiffres. En appuyant plusieurs fois sur la touche adéquate, vous pouvez saisir des lettres, des chiffres et des symboles. La touche étoile vous permet de passer de l'écriture majuscule à l'écriture minuscule

² L'affichage du numéro d'appel (**CLIP**³) est nécessaire pour l'affichage et la sauvegarde de numéros d'appel dans les listes des appels. L'affichage du numéro d'appel est un service optionnel de votre opérateur. Veuillez lui demander de plus amples informations. Vous trouverez d'autres informations sur l'affichage du numéro d'appel  page 66.

³ **CLIP** : Calling Line Identification Presentation

9 Fonctions spéciales

Prise de communication automatique (Prise directe)

Si vous avez activé la fonction, l'appel sera automatiquement réceptionné quand vous prendrez le combiné de la base. Régler la prise directe ➤ page 69.

Système de numérotation

Vous pouvez faire fonctionner votre téléphone aussi bien sur les raccordements analogiques (numérotation par impulsions/DC) que sur les nouveaux raccordements numériques (numérotation par tonalité/FV) Régler le système de numérotation ➤ page 70.

Numérotation temporaire par tonalité

Si vous ne pouvez utiliser votre téléphone qu'avec la numérotation par impulsions, vous n'avez pas besoin de renoncer aux avantages de la numérotation par tonalité (par ex. : consultation d'un répondeur dans le réseau téléphonique). Vous pouvez passer à la numérotation par tonalité pendant que vous passez une communication.

2 sec *

Appuyer dessus pendant la communication

Quand la communication est terminée, la numérotation par impulsions est automatiquement rétablie.

Appel direct

Cette fonction vous permet d'enregistrer un numéro déterminé qui, en actionnant une touche quelconque (sauf la touche softkey Opt) sera appelé automatiquement. Activer l'appel direct ➤ page 69.

Opt , ▲ ou ▼

Appel direct Off , OK

Désactiver l'appel direct

Fonctions spéciales

Numéros d'appel d'urgence

Dans votre combiné, vous pouvez enregistrer 4 numéros d'appel d'urgence. Vous pouvez les appeler même si votre clavier est verrouillé. Enregistrer des numéros d'appel d'urgence ☞ page 69.

Mode variateur

Réglage	Effet
Éteint	L'éclairage de l'écran s'éteint au bout de 30 secondes.
Toujours allumé	L'éclairage de l'écran est baissé au bout de 30 secondes et reste branché.
Pour 10 min	L'éclairage de l'écran est baissé au bout de 30 secondes et s'éteint au bout de 10 minutes.

10 SMS

Conditions pour les SMS

Votre raccordement téléphonique doit disposer du critère de performance **CLIP**¹. Assurez vous auprès de votre opérateur que ce service est bien activé sur votre raccordement téléphonique. Pour utiliser le service **SMS**², celui-ci doit être activé auprès de votre de votre exploitant de réseau.

- Des SMS ne peuvent pas être envoyés à partir de chaque installation à postes supplémentaires.



Si vous désirez envoyer un SMS à partir d'une installation à postes supplémentaires, enregistrez dans votre combiné le chiffre de la ligne principale de votre installation à postes supplémentaires avant le numéro de centre de service.

- Les envois SMS ne sont pas encore possibles avec les connexions d'appel par appel.
- Les envois de messages SMS sont payants.
- Si le récepteur n'utilise pas de service SMS sur son réseau fixe ou si son téléphone ne peut simplement pas recevoir de SMS, le SMS sera automatiquement livré sous forme de message vocal.
- Le calcul des frais est effectué par votre opérateur.

Centre de services SMS

La distribution de messages SMS se fait par un centre de services ou centre serveur. Si vous désirez envoyer des messages écrits SMS, vous devez programmer un numéro de centre de services dans votre combiné  page 67. Veuillez demander au fournisseur de votre choix le centre de services nécessaire et la façon de procéder pour activer le service SMS.



Votre téléphone est prêt à envoyer des messages écrits SMS. Des numéros de centres de services sont déjà programmés dans votre combiné. Activez le centre de services désiré dans le menu SMS.  Page 68

Centre de services 1

Swisscom : 0622100000

Centre de services 2

Cablecom: 0435375370

F

¹ **CLIP** : Calling Line Identification Presentation

² **SMS** : Short Message Service

Centre de services 3

Centre de services 4

Vide

Vide

Saisie de texte

Pour permettre la saisie de textes, des lettres sont inscrites sur les touches chiffrées. En appuyant plusieurs fois sur la touche adéquate, vous pouvez saisir des lettres, des chiffres et des symboles.

0 , 1 ou #	Entrer les caractères spéciaux
*	Passer entre écriture majuscule et minuscule ou entrée chiffrée
Eff	Effacer la dernière position
2 sec Eff	Effacer tout

Signal indicateur SMS (Alarm)

Quand vous avez reçu de nouveaux SMS, un signal indicateur vous en informe. Vous pouvez l'activer ou le désactiver. Activer et désactiver le signal indicateur  page 68.

Élargissement du système téléphonique

11 Élargissement du système téléphonique

Via le **GAP¹répondant à la norme internationale** la compatibilité de combinés et de bases de différents fabricants est réglée de façon standard. Ainsi est-il possible d'intégrer des appareils SWITEL et des appareils d'autres fabricants conjointement dans un système téléphonique. Il est toutefois possible que certaines fonctions ne soient plus disponibles.

Plusieurs combinés



Vous pouvez déclarer au total 5 combinés sur votre base.

Déclarer des combinés

Avant de déclarer un combiné, vous devez placer la base en mode d'enregistrement.

10 sec  

Démarrer le mode d'enregistrement

Déclarez maintenant le combiné  page 70. Pour cela, utilisez le code PIN actuellement paramétré  page 70.

Un numéro d'appel interne est attribué automatiquement au combiné après la déclaration. Ce numéro d'appel interne est affiché à l'écran.



Pour déclarer des combinés d'autres fabricants, veuillez lire leurs modes d'emploi.

Annuler des combinés





Ce combiné peut annuler soi-même ou d'autres combinés déclarés sur cette base. Sur l'écran du combiné annulé apparaît le message "Pas de base!".

Annulation de combinés  page 70.

Plusieurs bases

Vous pouvez élargir la portée de votre combiné si vous le déclarez simultanément à plusieurs bases. Vous pouvez le déclarer simultanément à 4 bases différentes. Chaque base a besoin d'une prise téléphonique individuelle. Ces raccordements peuvent porter le même numéro d'appel ou bien des numéros différents.

Placez d'autres bases dans le mode d'enregistrement. Déclarez le combiné  page 70. Via le menu "Sélection base" choisissez la base via laquelle vous désirez téléphoner  page 69.

¹ **GAP**: **Generic Access Profile** = Standard pour l'action conjointe de combinés et de bases de fabricants différents.

12 En cas de problèmes

Si vous avez des problèmes avec votre téléphone, contrôlez d'abord les remarques suivantes. Lors de problèmes techniques ou de droits à la garantie, adressez-vous à votre revendeur. La durée de la garantie est de 2 ans.

Questions et réponses

Questions	Réponses
Pas de connexion possible avec la base	<ul style="list-style-type: none">- Contrôlez si vous vous êtes bien identifié sur la base par le code PIN correct. ☞ page 70
Pas de communication téléphonique possible	<ul style="list-style-type: none">- Le téléphone n'est pas raccordé correctement ou en dérangement. N'utilisez que le câble de raccordement téléphonique fourni avec l'appareil.- Testez avec un autre téléphone si votre raccordement téléphonique fonctionne.- Le bloc d'alimentation n'est pas branché ou il y a une panne totale de courant.- Les piles rechargeables sont vides ou défectueuses.- Vous vous êtes trop éloigné de la base.- Erreur de réglage du système de numérotation. ☞ page 70
La liaison est hachée, coupée	<ul style="list-style-type: none">- Vous vous êtes trop éloigné de la base.- Mauvais lieu d'installation de la base.
Le système ne réagit plus	<ul style="list-style-type: none">- Remettez toutes les fonctions en configuration usine. ☞ page 80- Retirez le bloc d'alimentation de la prise de courant pendant un court instant.- Retirez un temps bref les piles rechargeables de votre combiné.

Questions	Réponses
Les piles rechargeables sont vides au bout de peu de temps	<ul style="list-style-type: none">- La pile rechargeable est vide ou défectueuse.- Placez le combiné correctement sur sa base. Nettoyez les surfaces de contact du combiné et de la base avec un chiffon doux et non pelucheux.- Posez le combiné sur la base et laissez-le pendant 16 heures .
L'affichage du numéro d'appel (CLIP ¹) ne fonctionne pas	<ul style="list-style-type: none">- L'affichage du numéro d'appel est un service optionnel de votre exploitant de réseau. Veuillez lui demander de plus amples informations.- Le correspondant a bloqué la transmission de son numéro d'appel.
Le répondeur n'enregistre pas de messages / mémos	<ul style="list-style-type: none">- Assurez-vous que celui-ci est correctement connecté et branché.- Contrôlez si la mémoire du répondeur est pleine. Supprimez des messages, le cas échéant. ☞ page 61
Vous ne pouvez pas exécuter de consultation à distance	<ul style="list-style-type: none">- Contrôlez si vous utilisez bien le code de sécurité correct pour cette consultation. ☞ page 63- Le téléphone que vous utilisez pour la consultation à distance doit être réglé sur numérotation par tonalité.

¹ CLIP : Calling Line Identification Presentation

Caractéristiques techniques

13 Caractéristiques techniques

Données techniques

Caractéristique	Valeur
Standard	DECT-GAP¹
Alimentation en courant (base)	Entrée : 220/230 V, 50 Hz Sortie : 6 V, 600 mA
Portée	A l'extérieur : env. 300 m A l'intérieur : env. 50 m
Etat de veille	jusqu'à 100 h
Durée max. de communication	Jusqu'à 10 h
Piles rechargeables	2 x 1.2 V, taille : AAA
Numérotation	Numérotation par tonalité Numérotation par impulsions
Température ambiante autorisée	10°C à 30°C
Humidité atmosphérique relative autorisée	20% à 75%
Fonction de flash	80 ms, 100 ms, 120 ms, 180 ms, 250 ms, 300 ms, 600 ms, 800 ms

Réglages usine

Combiné

Établir à nouveau les réglages en usine  page 69

Langue: allemand	Numéro d'appel d'urgence 1: Vide
Mélodie de sonnerie d'appel : 6	Numéro d'appel d'urgence 2: Vide
Mode variateur: Pour 10 min	

¹ **DECT**: Digitally Enhanced Cordless Telecommunication = Standard pour téléphones sans fil.

GAP: Generic Access Profile = Standard pour l'action conjointe de combinés et de bases de fabricants différents.

Caractéristiques techniques

Volume de la sonnerie : 5	Numéro d'appel d'urgence 3 : Vide
Volume sonore de l'écouteur : 3	Numéro d'appel d'urgence 4 : Vide
Volume mode mains libres : 3	Son des touches : activé
Répertoire : Vide	Nom MT : DFT727
Liste d'appels : Vide	SMS: Vide
BIS : Vide	Signal indicateur : activé
Babycall : Arrêt / Vide	Prise directe : activé
Code réseau : Vide	Contraste de l'écran : 4
Verrouillage du clavier : Désactivé	Couleur menu : bleu
Avertissement batterie : activé	Éclairage touches : activé
Avertissement portée : activé	Fond d'écran : ciel

Base

Établir à nouveau les réglages en usine  page 70

Mélodie de sonnerie d'appel : 1	Temps de flash : 100 ms
Volume de la sonnerie : 5	Numérotation : num. par tonalité
Répertoire VIP: Vide	Code PIN : 0000

Répondeur

Retardement : 4 sonneries d'appel	Mode des annonces avec enregist.
Répondeur : activé	Volume : 3

Déclaration de conformité

Cet appareil répond aux exigences des directives de l'union européenne (UE) :

1999/5/CE Directive sur les installations de radio et de télécommunication et la reconnaissance réciproque de leur conformité. La conformité avec la directive mentionnée ci-dessus est confirmée sur l'appareil par la marque CE.

Vous trouverez toute la déclaration de conformité au verso de ce mode d'emploi.



F

14 Remarques d'entretien / Garantie

Remarques d'entretien

- Nettoyez les surfaces du boîtier avec un chiffon doux et non pelucheux.
- N'utilisez pas de produits d'entretien ou de solvants.

Garantie

Les appareils SWITEL sont fabriqués selon les procédés les plus modernes et sont contrôlés. Des matériels sélectionnés et des technologies de pointe ont pour effet un fonctionnement irréprochable et une longue durée de vie. La garantie ne rentre pas en jeu si l'exploitant du réseau téléphonique ou une installation à postes supplémentaires éventuellement intercalée est responsable du dysfonctionnement de l'appareil. La garantie n'est pas valable pour les piles, piles rechargeables ou packs de piles utilisés dans le produits. La durée de la garantie est de 24 mois, à partir de la date d'achat.

Pendant la durée de la garantie, tous les défauts, dus à des vices de matériel ou de fabrication, seront éliminés gratuitement. Le droit à la garantie expire en cas d'intervention de l'acheteur ou de tiers. Les dommages provenant d'un manie-ment ou d'une manipulation incorrects, d'une mauvaise mise en place ou d'une mauvaise conservation de l'appareil, d'un raccordement non conforme ainsi que d'un cas de force majeure ou autres influences extérieures, sont exclus de la ga-rantie. Nous nous reservons le droit, en cas de réclamations, de réparer ou de remplacer les composants défectueux ou d'échanger l'appareil. Les composants remplacés ou les appareils échangés deviennent notre propriété. Les demandes de dommages et intérêts sont exclues tant qu'elles ne reposent pas sur l'inten-tion ou une négligence grossière du fabricant.

Si votre appareil devait malgré tout présenter une défectuosité pendant la pé-riode de garantie, veuillez vous adresser, muni de la quittance d'achat, exclusi-vement au magasin où vous avez acheté votre appareil SWITEL. Vous ne pou-vez faire valoir vos droits à la garantie selon ces dispositions qu'auprès de votre revendeur exclusivement. Deux ans après l'achat et la remise de nos produits, il n'est plus possible de faire valoir les droits à la garantie.

15 Index

A

- Affichage du numéro d'appel, 66
- Alarme SMS , 76
- Annuler des combinés, 77
- Appel direct, 73
- Appeler, 54

B

- Branchement / débranchement du répondeur, 58
- Branchement à distance du répondeur, 64
- Branchement et débranchement du combiné, 57

C

- Centre de services SMS, 75
- Chargement des piles rechargeables, 48
- Chercher le combiné, 57
- Chiffre de la ligne principale, 65
- Comment me servir du téléphone, 50
- Composition de numéros du répertoire, 54
- Conditions pour les SMS, 75
- Consignes de sécurité, 45
- Consultation à distance, 63
- Consultation à distance code de sécurité , 63
- Contenu de l'emballage, 47
- Créer des enregistrements dans le répertoire, 53

D

- Débranchement du microphone, 57
- Déclaration de conformité, 81
- Déclarer des combinés, 77
- Données techniques, 80
- Durée d'enregistrement maximale, 58
- Durée de la communication, 56

E

- Ecoute amplifiée de messages entrants, 59
- Écouter les mémos, 61
- Écouter les messages, 61
- Effacer les mémos, 61
- Effacer les messages, 61
- Élargissement du système téléphonique, 77
- Éléments de manipulation, 49
- En cas de problèmes, 78
- Enregistrement d'un mémo, 61
- Enregistrement des annonces, 60
- Entrer manuellement la pause de numérotation, 65

F

- Fonctions des touches de la consultation à distance, 64
- Fonctions spéciales, 73

G

- Garantie, 82

I

- Installations à postes supplémentaires, 65
- Intercommunication, 56

M

- Mélodie de sonnerie d'appel, 57
- Mener des conférences téléphoniques, 56
- Menu principal, 67
- Mettre le téléphone en service, 47
- Mode économique, 59
- Mode mains-libres, 57
- Mode variateur, 68, 74

N

- Niveau de chargement des piles rechargeables, 48
- Notations, 50
- Numéros d'appel d'urgence, 74
- Numérotation en chaîne et transmission de numéros, 55
- Numérotation par impulsion, 70
- Numérotation par tonalité (DTMF), 70
- Numérotation temporaire par tonalité, 73

P

- Paging, 57
- Pause de numérotation automatique, 65
- Plusieurs bases, 77
- Plusieurs combinés, 77
- Pose des piles rechargeables, 48
- Prendre l'appel, 54
- Prise d'appel, 59
- Prise de communication automatique, 73
- Prise directe, 73

Q

- Questions et réponses, 78

R

- Raccordement de la base, 47
- Rappel des appels entrés, 54
- Réglage du jour de la semaine et de l'heure du répondeur, 58
- Réglages usine, 80
- Régler le nombre des sonneries d'appel, 59
- Régler le volume sonore du répondeur, 59
- Remarques d'entretien, 82
- Répertoire, 72
- Répondeur, 58
- Répondeur dans le réseau téléphonique, 66
- Représentations, 50

S

- Saisie de texte, 76
- Sélectionner le mode des annonces, 60
- Services supplémentaires, 65
- Signal indicateur SMS, 76
- Simple annonce, 60
- Structure du menu, 67
- Suppression de tous les message / mémos, 62
- Suppression des annonces, 60
- Suppression des anomalies, 78
- Symboles à l'écran, 50
- Système de numérotation, 70, 73

T

- Téléphoner, 54
- Téléphoner en interne, 55
- Temporisation, 59
- Temps flash, 70
- Terminer la communication, 54
- Touche de répétition automatique des derniers numéros, 54
- Touche R et services supplémentaires, 65
- Touche R sur les installations à postes supplémentaires, 65
- Touches de navigation, 52
- Transférer des communications externes à des internes, 55

V

- Va-et-vient, 56
- Verrouillage du clavier, 57
- VMWI, 66
- Volume sonore de l'écouteur, 56

1	Indicazioni di sicurezza	86
2	Mettere in funzione il telefono	88
3	Elementi di comando	90
4	Come funziona il mio telefono?	91
5	Compiere telefonate	95
6	Segreteria telefonica	99
7	Impianti telefonici interni / Servizi aggiuntivi .	106
8	Struttura di menu	108
9	Funzioni speciali	114
10	SMS	116
11	Ampliare il sistema telefonico	118
12	In caso di problemi	119
13	Specifiche tecniche	121
14	Consigli per la cura / Garanzia	123
15	Indice alfabetico	124

Indicazioni di sicurezza

1 Indicazioni di sicurezza

Leggere attentamente le presenti istruzioni per l'uso.

Impiego conforme agli usi previsti

Il presente apparecchio consente di compiere telefonate all'interno di una rete di telecomunicazione. Qualsiasi altro impiego è considerato come non conforme agli usi previsti. Non sono consentite modifiche o trasformazioni non autorizzate. Non aprire per nessuna ragione l'apparecchio autonomamente e svolgere riparazioni di propria iniziativa.

Luogo di installazione

Evitare un'esposizione a fumo, polvere, vibrazioni, sostanze chimiche, umidità, calore e raggi solari diretti.

Non utilizzare l'unità portatile in aree esposte al rischio di deflagrazione.

Alimentatore di rete



Attenzione: Utilizzare solo l'alimentatore a spina fornito in dotazione visto che altri alimentatori di rete potrebbero addirittura danneggiare il telefono. Non ostacolare il libero accesso all'alimentatore a spina con mobili o altri oggetti simili.

Batterie ricaricabili



Attenzione: Non gettare le batterie ricaricabili nel fuoco, né sommergerle in acqua.

Caduta di tensione

In caso di caduta di tensione non è possibile impiegare l'unità per telefonare. Si consiglia di ricorrere in caso di emergenza ad un telefono con filo in grado di funzionare anche senza alimentazione elettrica esterna.

Apparecchiature mediche



Attenzione: Evitare di utilizzare il telefono nelle vicinanze di apparecchiature mediche. Non è possibile escludere completamente il rischio di eventuali interferenze.

Telefoni **DECT**¹ possono causare un fastidioso ronzio in apparecchi acustici.

¹ **DECT:** Digital Enhanced Cordless Telecommunication = Standard per telefoni senza cavo.

Smaltimento

Alla fine della vita utile dell'apparecchio si ricorda che è necessario consegnare l'apparecchio vecchio presso uno dei punti di raccolta istituiti dalla propria società di smaltimento rifiuti comunale (per es. centro di riciclo materiali). Il simbolo qui raffigurato indica il divieto di smaltire l'apparecchio vecchio assieme ai rifiuti domestici. Secondo quanto previsto dalla legge sugli apparecchi elettrici ed elettronici i proprietari di apparecchi vecchi sono per legge tenuti alla consegna di tutti gli **apparecchi elettrici ed elettronici** presso un centro di rilievo rifiuti in raccolta differenziata.



Consegnare batterie ed accumulatori per lo smaltimento presso rivenditori al dettaglio di batterie o centri di raccolta che mettono a disposizione appositi contenitori. **Smaltire confezioni ed imballaggi** in base a quanto indicato dalle norme in vigore a livello locale.



Mettere in funzione il telefono

2 Mettere in funzione il telefono

Indicazioni di sicurezza



Attenzione: Prima della messa in funzione, leggere attentamente le indicazioni di sicurezza riportate al capitolo 1.

Verificare il contenuto della confezione

La confezione contiene:

- una stazione base con alimentatore di rete
- un cavo di collegamento telefonico
- un'unità portatile
- due batterie ricaricabili
- un manuale di istruzioni per l'uso

Collegare la stazione base



Attenzione: Posizionare la stazione base con una distanza minima di 1 m da altre apparecchiature elettroniche considerato il rischio di interferenze reciproche.

Procedere al collegamento della stazione base seguendo quanto raffigurato sul disegno. Utilizzare per motivi di sicurezza solo l'alimentatore di rete (6V, 600mA) oltre che il cavo di collegamento telefonico forniti in dotazione.

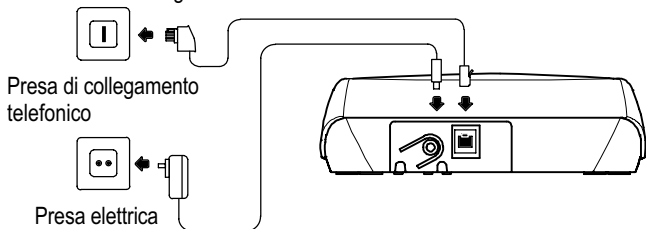

Mettere in funzione il telefono

Inserire le batterie ricaricabili

Inserire le batterie ricaricabili nel vano batterie precedentemente aperto. Utilizzare a tale scopo solo batterie ricaricabili del tipo AAA Ni-MH da 1,2 V. Osservare la corretta polarità! Chiudere infine il vano accumulatore.

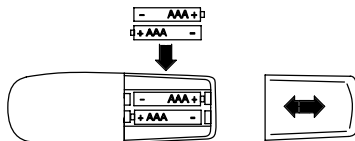

Caricare le batterie

Riporre l'unità portatile in sede di prima messa in funzione per minimo 16 ore nella stazione base. Avendo posizionato l'unità portatile in maniera corretta nella stazione base, si avverte un segnale di avviso. L'unità portatile si surriscalda durante il processo di carica. Questo è un fenomeno normale e non pericoloso. Evitare di caricare l'unità portatile con dispositivi di carica differenti o estranei. Lo **stato di carica** attuale è visualizzato sul display:



Carico



A metà



Debole



Scarico

Impostare ora e data dell'unità portatile

Una voce di menu consente di impostare ora e data. A pagina 111 è indicata la posizione da scorrere nel menu.

Impianti telefonici interni

A pagina 106 sono riportate ulteriori informazioni in caso si volesse collegare il telefono ad un impianto telefonico interno.

Impostare giorno settimanale e ora della segreteria telefonica

Giorno della settimana e ora della segreteria telefonica sono impostati automaticamente assieme all'unità portatile.

Elementi di comando

3 Elementi di comando

Unità portatile

- 1 Scorrere verso sopra / Elenco chiamate
- 2 Tasto softkey a destra
- 3 Rubrica telefonica
- 4 Tasto R (flash)
- 5 Scorrere verso sotto
- 6 Agganciare / Unità portatile ON / OFF
- 7 Tasto cancelletto / Blocco tastiera
- 8 Disattivare segnalazione di chiamata / Selezione a toni temporanea
- 9 Rispondere alla chiamata
- 10 Funzione viva voce
- 11 Indietro / Silenziamento microfono
- 12 Tasto softkey a sinistra
- 13 Tasto di menu "Info"

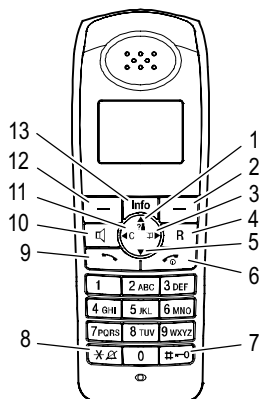

Stazione base (segreteria telefonica)

- 1 Ricerca di unità portatile (tasto di paging)
- 2 Segreteria telefonica ON / OFF
- 3 LED di visualizzazione di chiamata
- 4 Saltare indietro
- 5 Cancellare
- 6 Riproduzione / Stop
- 7 LED di controllo dello stato di carica
- 8 Saltare in avanti
- 9 Volume +
- 10 Volume -

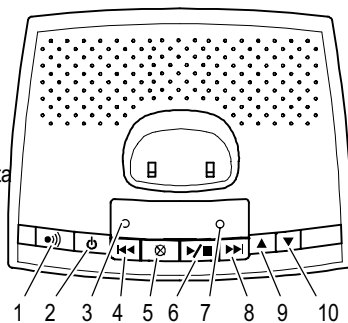











I tasti riportati nelle presenti istruzioni per l'uso sono raffigurati con un contorno uniforme. Con riserva di modifiche per tasti e simboli visualizzati sul display del telefono rispetto a tasti e simboli di display qui raffigurati.







Come funziona il mio telefono?

4 Come funziona il mio telefono?





Rappresentazioni e modi di scrittura

	Inserire numeri o lettere
	Premere brevemente il tasto raffigurato
2 sec 	Premere il tasto raffigurato per 2 secondi
	Unità portatile squilla
	Stazione base squilla
	Estrarre l'unità portatile dalla stazione base
	Riporre l'unità portatile nella stazione base
Deutsch oppure 	Testo o simboli sul display
Ok 	Premere il tasto softkey  pagina 93

Simboli sul display

Display	Descrizione
	Permanente: Collegamento con la stazione base è buono. Suoni di avviso: Il collegamento si interrompe. Disattivo: Il collegamento è interrotto. Avvicinarsi alla stazione base.
	La funzione vivavoce è attivata.  pagina 98
	Permanente: Chiamata telefonica in corso. Lampeggiante: Il telefono squilla.  pagina 95
	La segnalazione acustica di chiamata è disattivata.  pagina 98

Come funziona il mio telefono?

Display	Descrizione
	Il microfono è disattivato. ➤ pagina 98
 e Blocco tasti	Il blocco tastiera è attivato. ➤ pagina 98
	Permanente: Indicazione dello stato di carica delle batterie. In scorrimento: Processo di carica delle batterie in corso. ➤ pagina 89
DFT727	Nome dell'unità portatile. ➤ pagina 118
1	Numero di chiamata interno dell'unità portatile. ➤ pagina 118
01.12 13:26	Indicazione di data e ora. ➤ pagina 111
 e Nuove chiamate	Presenza di nuove chiamate nell'elenco chiamate. ➤ pagina 113 e 107 In più il LED rosso lampeggia dietro al tasto Info.
 e Nuovo SMS	Presenza di un nuovo SMS ¹ . ➤ pagina 108 e 116
	Segreteria telefonica su rete telefonica. VMWI ² - Servizio opzionale del proprio gestore di rete telefonica. ➤ pagina 107

¹ **SMS**: Short Message Service

² **VMWI**: Visual Message Waiting Indication

Come funziona il mio telefono?

Tasti di navigazione

Tutte le descrizioni riportate nelle presenti istruzioni per l'uso tengono conto dell'unità portatile in stato di stand-by. La modalità di stand-by è selezionata premendo il tasto .



I tasti softkey (1) e (7) sono programmati con funzioni differenti in base al menu in cui ci si trova. Nelle presenti istruzioni per l'uso questi tasti sono denominati sempre in base ai testi di display visualizzati direttamente al di sopra.

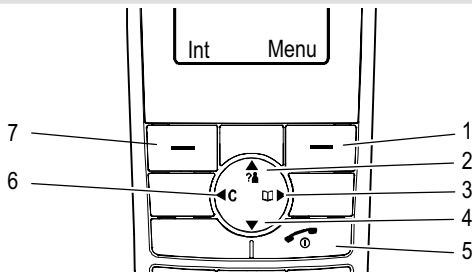

Tasto	In modalità di stand-by	All'interno del menu
1	- Aprire il menu principale	- Aprire il menu visualizzato
2	- Aprire l'elenco chiamate	- Scorrere verso sopra - Modificare le impostazioni
3	- Aprire la rubrica telefonica	- Spostare a destra
4		- Scorrere verso sotto - Modificare le impostazioni
5	- Attivare/Disattivare l'unità portatile	- Interrompere le procedure di programmazione e memorizzazione
6		- Spostare a sinistra - Tornare indietro di un livello
7	- Chiamate interne	- Tornare indietro di un livello

Come funziona il mio telefono?

Navigazione nel menu

I differenti menu consentono di raggiungere tutte le funzioni del telefono. Il percorso da seguire per giungere alla funzione desiderata è indicato dalla struttura di menu. ☞ pagina 108

Menu	Aprire il menu principale
▲ o ▼, ◀ o ▶	Selezionare il sottomenu desiderato
Ok	Aprire il sottomenu
▲ o ▼	Selezionare la funzione desiderata
Ok	Aprire la funzione
▲ o ▼	Selezionare l'impostazione desiderata
☞	La tastiera consente di inserire numeri/lettere
Ok oppure Mem	Confermare o salvare le immissioni
◀ o <<	Tornare indietro di un livello
☎	Interrompere le procedure di programmazione e memorizzazione e tornare indietro alla modalità di stand-by

☞ Ogni singolo processo si interrompe automaticamente se entro 30 secondi non si procede con una immissione.

Creare voci nella rubrica telefonica - Esempio

Come navigare nei menu e compiere immissioni è indicato dall'esempio **Creare voci nella rubrica telefonica**. Si consiglia di seguire l'esempio riportato per tutte le altre impostazioni che si desiderano compiere.

☞	Aprire la rubrica telefonica
Opz	Aprire il menu opzioni
▲ o ▼	
Nuova voce, Ok	Selezionare e confermare la funzione
Numero ☞, Ok	Inserire il numero di chiamata (max. 24 cifre) e confermare
Nome: ☞, Mem	Inserire il nome (max. 15 caratteri) e confermare

5 Compiere telefonate

Ricevere una chiamata



Ricevere una chiamata

Concludere una chiamata



Concludere una chiamata

Telefonare



Inserire un numero di chiamata (max. 24 cifre)

Canc

Cancellare l'ultima cifra in caso di immissione errata



Selezionare un numero di chiamata



Premendo il tasto di chiamata per 2 secondi si ottiene un segnale di libero. Le cifre immesse per la composizione del numero di chiamata desiderato sono immediatamente selezionate. Nel corso di una simile chiamata non è possibile eseguire una correzione di singole cifre che compongono il numero di chiamata.

Ripetizione di selezione

Il telefono memorizza i 20 numeri di chiamata selezionati per ultimo in un elenco di ripetizione di chiamata.



Aprire l'elenco di ripetizione di chiamata



Selezionare la voce e instaurare un collegamento

Riselezione chiamate ricevute

Il telefono memorizza fino a 30 chiamate ricevute in un elenco chiamate.



Aprire l'elenco chiamate



Selezionare la voce e instaurare un collegamento

Selezionare numeri dalla rubrica telefonica

Per fare questo è necessario aver memorizzato i numeri di chiamata nella rubrica telefonica.  pagina 94 e 113



Aprire la rubrica telefonica



Selezionare la voce e instaurare un collegamento



Compiere telefonate

Concatenare e trasmettere numeri

La funzione viene applicata per servizi telefonici più complessi come per es. banking via telefono, call by call o procedure con calling card. È possibile trasferire uno dopo l'altro diversi numeri memorizzati nella rubrica telefonica. La trasmissione di numeri dalla rubrica telefonica è combinabile con l'immissione di numeri manuale. Con chiamata in corso è possibile combinare e trasmettere un numero illimitato di numeri tratti dalla rubrica telefonica.



Aprire la rubrica telefonica



Selezionare la voce dalla rubrica telefonica e trasferire il numero

Compiere chiamate interne

Condurre chiamate interne

Per poter usufruire di questa funzione è necessario aver registrato due o più unità portatili (UP1, UP2, ...) presso la stazione base, in modo da condurre chiamate gratuite. Ulteriori informazioni pagina 118.

UP1: Int o

per es. Portatile 2

Selezionare il numero di chiamata interno dell'unità portatile desiderata

UP2:

Ricevere la chiamata interna presso l'altra unità portatile

UP1 / UP2:

Concludere la chiamata interna

Inoltro interno di chiamate esterne

UP1: Int o

per es. Portatile 2

Selezionare con chiamata esterna in corso il numero interno

UP2:

Ricevere la chiamata interna presso l'altra unità portatile

UP1:

Trasferire la chiamata



Se l'unità portatile selezionata non risponde, è possibile riprendere la chiamata esterna premendo il tasto .

Compiere telefonate

Riscontro / Chiamata in attesa

Durante lo svolgimento di una chiamata esterna è possibile chiamare un'altra unità portatile allo scopo di consultarsi o eseguire un riscontro. Mentre è in corso la conversazione con l'interlocutore interno, la chiamata esterna è trattenuta. Il numero di passaggi tra i partner di chiamata è illimitato.

UP1: Int ,  o 

per es. Portatile 2 , Ok

Selezionare con chiamata esterna in corso il numero interno

UP2: 

Ricevere la chiamata interna presso l'altra unità portatile

UP1: Att

Cambiare il partner di chiamata

Compiere chiamate a conferenza

Questa funzione consente di condurre una conferenza con una chiamata esterna ed un altro interlocutore interno.

UP1: Int ,  o 

per es. Portatile 2 , Ok

Selezionare con chiamata esterna in corso il numero interno

UP2: 

Ricevere la chiamata interna presso l'altra unità portatile

UP1: Conf

Avviare una conferenza



La funzione consente di passare da un partner di chiamata all'altro e di attivare la modalità di chiamata in conferenza.

UP1 / UP2: 

La conferenza è conclusa nel momento in cui uno dei partner di chiamata interni conclude la chiamata

Impostare il volume del ricevitore

Il volume è regolabile durante lo svolgimento di una chiamata in 5 livelli.

 o 

Selezionare il volume desiderato

Visualizzazione della durata di conversazione

Durante lo svolgimento di una chiamata, la durata di conversazione è visualizzata in ore, minuti e secondi.

Compiere telefonate

Funzione vivavoce

Utilizzare questa funzione per ascoltare il partner di chiamata attraverso l'altoparlante.



Attivare la funzione vivavoce



Disattivare la funzione vivavoce

Silenziamento del microfono nell'unità portatile

È possibile attivare e disattivare il microfono dell'unità portatile con chiamata telefonica in corso.



Disattivare il microfono (silenziamento)



Attivare il microfono

Blocco tastiera

3 sec

Attivare il blocco tastiera



L'attivazione del blocco tastiera consente di ricevere telefonate in arrivo come di consueto.

3 sec

Disattivare il blocco tastiera

Melodia di suoneria dell'unità portatile

È possibile disattivare la melodia della segnalazione di chiamata dell'unità portatile.

3 sec

Disattivare la melodia di suoneria



L'impostazione della segnalazione acustica di chiamata presso la stazione base rimane invariata.

3 sec

Attivare la melodia di suoneria

Ricerca dell'unità portatile (funzione di paging)

Avendo perso d'occhio la propria unità portatile è possibile ritrovarla facilmente grazie all'emissione di un tono di ricerca.



Avviare il tono di ricerca

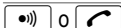

Interrompere il suono di paging

Attivare e disattivare l'unità portatile

Per risparmiare le batterie ricaricabili è possibile spegnere l'unità portatile.

2 sec Disatt. port.?

Sì oppure **No**

Confermare o interrompere

2 sec

Attivare l'unità portatile

6 Segreteria telefonica

Tutte le funzioni della segreteria telefonica sono comandabili attraverso l'unità portatile. Alcune funzioni sono in più direttamente disponibili presso la stazione base.



La segreteria telefonica offre all'utente delle istruzioni sotto forma di guida parlata. Osservare le istruzioni e avvertenze fornite.

Per passare al menu impostazioni della segreteria telefonica:

Menu	Aprire il menu principale
◀ o ▶	
Segreteria tel. , Ok	Aprire il menu segreteria telefonica
◀ o ▶	
Impost. segret. , Ok	Aprire il menu impostazione

Impostare data e ora

Durante la riproduzione dei messaggi, ogni messaggio è accompagnato dall'indicazione di data e ora in cui il messaggio è stato ricevuto. Giorno della settimana e ora della segreteria telefonica sono impostati automaticamente assieme all'unità portatile. ☞ pagina 111

Attivare / Disattivare la segreteria telefonica

Sulla stazione base:

	Attivare / Disattivare la segreteria telefonica
--	---

Sull'unità portatile nel menu segreteria telefonica:

▲ o ▼	
Risposta ON/OFF , Ok	Selezionare e confermare la funzione
▲ o ▼ OFF oppure	
ON , Ok	Selezionare e confermare l'impostazione

Durata di registrazione massima

La segreteria telefonica è in grado di memorizzare fino a 99 messaggi. La durata di registrazione massima è di 15 minuti. Se la capacità di memoria è esaurita e la registrazione di nuovi messaggi non è più possibile, non sarà più registrata alcuna chiamata.



Segreteria telefonica

Impostare il volume

Il volume della guida utente è impostabile in 6 livelli.

Sulla stazione base:

 o  Impostare il volume

Sull'unità portatile:

 o  Impostare il volume

Impostare il numero di segnalazioni di chiamata (ritardo)

È possibile scegliere da 2 a 8 segnalazioni di chiamata e l'impostazione **Mod. risparmio** per un'interrogazione a distanza preliminare senza alcun addebito.

Con la funzione di interrogazione a distanza preliminare gratuita è possibile verificare la presenza di nuovi messaggi sulla propria segreteria telefonica.

- Se ci sono messaggi nuovi sulla segreteria telefonica, l'apparecchio accetta la telefonata dopo sole 2 segnalazioni di chiamata.
- Se la chiamata non è accettata dopo 6 squilli, non c'è nessun nuovo messaggio. Riagganciare prima del 6° squillo. In questo modo non si verifica alcun addebito.

Nel menu impostazioni:

 o 
 , Selezionare e confermare la funzione

 o 
per es. , Selezionare e confermare l'impostazione

Ulteriori informazioni sull'interrogazione a distanza  pagina 104

Intercettare messaggi in arrivo

È possibile ascoltare chiamate in arrivo senza bisogno di accettare la chiamata.

Attivare l'intercettazione di chiamate

Disattivare l'intercettazione di chiamate

Riprendere una chiamata

Anche se la segreteria telefonica ha già risposto ad una chiamata è comunque possibile riprendere la telefonata. Fatto questo, la registrazione del messaggio si interrompe.

 Rispondere ad una chiamata

Selezionare la modalità di annuncio

La segreteria telefonica dispone di due messaggi di annuncio predefiniti. Dopo il "Messaggio di annuncio con registrazione" è possibile lasciare un messaggio. Il "Messaggio di annuncio senza registrazione" corrisponde alla modalità di **Solo annuncio** dato che non è possibile lasciare alcun messaggio dopo aver ascoltato l'annuncio. I messaggi di annuncio possono essere sostituiti da messaggi di annuncio personalizzati. Non appena la memoria della segreteria telefonica è piena, l'apparecchio riproduce automaticamente l'annuncio senza registrazione di messaggi.

Nel menu impostazioni:

▲ o ▼
Mod. risposta , Ok Selezionare e confermare la funzione

▲ o ▼ Con registr.
oppure Senza registr. , Ok Selezionare e confermare l'impostazione

Registrare, verificare o cancellare degli annunci

Registrare degli annunci

La lunghezza del proprio annuncio non deve essere superiore a 2 minuti.

Nel menu impostazioni:

▲ o ▼
Annuncio , Ok Aprire il menu annunci

▲ o ▼
Reg. annuncio , Ok Selezionare e confermare la funzione

▲ o ▼ Con registr.
oppure Senza registr. , Ok Selezionare e confermare l'annuncio

☞, Salva Registrare e salvare l'annuncio

Verificare l'annuncio attualmente impostato

Nel menu annunci:

▲ o ▼
Senti annuncio , Ok Selezionare e confermare la funzione

▲ o ▼ Con registr.
oppure Senza registr. , Ok Selezionare e confermare l'annuncio

Segreteria telefonica

Cancelare l'annuncio personalizzato e fare ritorno all'annuncio standard

Cancelando l'annuncio personalizzato viene automaticamente riattivato l'annuncio standard.

Nel menu annunci:



Senti annuncio

, Ok

Selezionare e confermare la funzione

Canc

Cancelare con riproduzione in corso

Registrare dei promemoria

Un promemoria è un messaggio che è possibile riprodurre e quindi ascoltare allo stesso modo di un messaggio ricevuto.

Registrare un promemoria

Nel menu segreteria telefonica:



Registra memo

, Ok

Selezionare e confermare la funzione



Mem

Registrare e salvare il promemoria

Riprodurre o cancellare messaggi / promemoria registrati

Riprodurre messaggi

I messaggi ricevuti / promemoria registrati sono riprodotti nell'ordine cronologico in cui sono salvati dall'apparecchio. Il giorno della settimana e l'ora sono indicati prima della riproduzione del rispettivo messaggio o promemoria.

Sulla stazione base:



Riproduzione



Interrompere la riproduzione



Ripetere il messaggio



Riprodurre il messaggio precedente



Messaggio successivo

Sull'unità portatile nel menu segreteria telefonica:



Senti messaggio

, Ok

Aprire il menu messaggi

Ulteriore esercizio Funzioni a tasti nel menu messaggi

Cancellare un messaggio

Sulla stazione base:

 Riprodurre il messaggio da cancellare

 Cancellare il messaggio

Sull'unità portatile nel menu segreteria telefonica:



Senti messaggio , **Ok** Aprire il menu messaggi

5 Cancellare il messaggio in corso

Ulteriore esercizio  Funzioni a tasti nel menu messaggi

Funzioni a tasti nel menu messaggi

Tasto	Funzioni
2	Riproduzione / Stop
4 , <	Riprodurre il messaggio precedente
5	Cancellare il messaggio in corso
6 , > 	Riprodurre il messaggio successivo

Cancellare tutti i messaggi / promemoria

Tutti i messaggi / promemoria vecchi sono cancellati. Solo messaggi / promemoria nuovi rimangono memorizzati.

Sulla stazione base:

2 sec  Avviare la procedura di cancellazione

 Confermare la procedura di cancellazione

Sull'unità portatile nel menu segreteria telefonica:



Cancella tutto , **Ok** Selezionare e confermare la funzione

Cancellare? **Si** Confermare la procedura di cancellazione oppure

Cancellare? **No** Interrompere la procedura di cancellazione

Segreteria telefonica

L'interrogazione a distanza



È possibile chiamare la propria segreteria telefonica per ascoltare eventuali messaggi registrati o anche per svolgere altre funzioni. Requisito per questa operazione è un telefono abilitato alla selezione a toni.

Il codice di sicurezza per l'interrogazione a distanza



La configurazione iniziale del codice di sicurezza corrisponde a "0000". Per poter eseguire un'interrogazione a distanza è necessario modificare prima il codice di sicurezza "0000" impostato precedentemente in fabbrica. L'interrogazione a distanza è possibile solo se il codice di sicurezza non corrisponde a "0000".

Modificare il codice di sicurezza

Nel menu impostazioni:

 		
Mod. PIN remoto	Ok	Selezionare e confermare la funzione
Vecchio PIN	Ok	Inserire il codice di sicurezza vecchio
Nuovo PIN:	Ok	Inserire un nuovo codice di sicurezza
Ripeti PIN:	Ok	Ripetere il nuovo codice di sicurezza

Avviare l'interrogazione a distanza

		Selezionare il proprio numero di chiamata
#		Confermare durante l'annuncio e inserire il codice di sicurezza



In caso di immissione errata, l'annuncio della segreteria telefonica è nuovamente riprodotto. Se il codice di sicurezza è inserito erratamente per tre volte, il collegamento è interrotto automaticamente.

A questo punto è possibile compiere altre funzioni.  Tabella di funzioni a tasti dell'interrogazione a distanza

Segreteria telefonica

Attivazione a distanza della segreteria telefonica



Selezionare il proprio numero di chiamata



Avendo dimenticato di inserire la segreteria telefonica, la chiamata è ricevuta solo dopo 10 squilli.

#,

Confermare durante l'annuncio e inserire il codice di sicurezza

0

Attivare / Disattivare la segreteria telefonica

A questo punto è possibile compiere altre funzioni. Tabella di funzioni a tasti dell'interrogazione a distanza

Funzione a tasti dell'interrogazione a distanza



L'interrogazione a distanza è interrotta automaticamente se entro 8 secondi non si procede con una immissione.

La seguente tabella offre una panoramica delle singole funzioni a tasti.

Tasto	Funzioni
1	Ascoltare il menu ausiliario
2	Avviare la riproduzione di tutti i messaggi
3	Avviare la riproduzione dei messaggi nuovi
4	Ripetere il messaggio attuale
2 x 4	Riprodurre il messaggio precedente
5	Cancellare il messaggio in corso
6	Riprodurre il messaggio successivo
7	Selezionare la modalità di annuncio: "Messaggio di annuncio con registrazione" o "Messaggio di annuncio senza registrazione"
8	Ascoltare il messaggio di annuncio attualmente impostato
9	Registrare il messaggio di annuncio attualmente impostato
0	Attivare / Disattivare la segreteria telefonica
#	Concludere la registrazione del messaggio di annuncio
	Riagganciando il telefono la funzione di interrogazione a distanza è conclusa.

Impianti telefonici interni / Servizi aggiuntivi

7 Impianti telefonici interni / Servizi aggiuntivi

Tasto R in impianti telefonici interni

Avendo collegato il telefono ad un impianto telefonico interno, il **tasto R** consente di accedere a tutte le altre funzioni disponibili come per es. trasferimento di chiamata e funzione di richiamata automatica. Si prega di consultare le istruzioni per l'uso del proprio impianto telefonico interno per individuare il tempo flash da impostare al fine di poter usufruire di queste funzioni. Il rivenditore specializzato è in grado di indicare se il telefono acquistato funzionerà senza alcun problema nel proprio impianto telefonico interno. Impostare il tempo flash ➡ pagina 111.

Cifra per il segnale dalla centrale

In presenza di impianti telefonici interni è necessario selezionare un determinato numero prima di ottenere un segnale di libero che indica la disponibilità della linea di collegamento di rete. La cifra per il segnale dalla centrale è memorizzabile. Non appena il telefono riconosce la cifra per il segnale dalla centrale davanti ad un numero di chiamata inserito, l'apparecchio prevede **automaticamente una pausa di selezione** dopo la cifra per il segnale di linea libera. Impostare la cifra per il segnale dalla centrale ➡ pagina 111.

Inserire manualmente la pausa di selezione

Dopo la cifra per il segnale dalla centrale è possibile inserire **manualmente una pausa di selezione** e procedere direttamente alla selezione di un numero senza bisogno di attendere il segnale di libero.

2 sec **0**

Inserire la pausa di selezione

Dopo la cifra per il segnale dalla centrale il telefono attende 3 secondi prima di selezionare il numero di chiamata vero e proprio.



La pausa è anche programmabile in sede di immissione dei numeri di chiamata nella rubrica telefonica.

Tasto R e servizi aggiuntivi

Il telefono supporta servizi aggiuntivi messi a disposizione dal proprio gestore di rete telefonica come per es. le funzioni di chiamata in attesa, avviso di chiamata e chiamata a conferenza. Con il **tasto R** è possibile accedere a questi servizi aggiuntivi. Si prega di consultare il proprio gestore di rete telefonica per ottenere informazioni sul tempo flash necessario per l'utilizzo dei servizi aggiuntivi. Rivolgersi al proprio gestore di rete telefonica per ottenere l'abilitazione ai servizi aggiuntivi. Impostare il tempo flash ➡ pagina 111.

Impianti telefonici interni / Servizi aggiuntivi

Segreteria telefonica integrata nella rete telefonica

Se il gestore di rete telefonica offre una segreteria telefonica nell'ambito della propria rete di telecomunicazione, sul display è visualizzato il simbolo di una cassetta postale (**VMWI**¹) che informa sulla presenza di nuovi messaggi. La segreteria telefonica e l'informazione sulla presenza di nuovi messaggi con un simbolo sono servizi aggiuntivi del proprio gestore di rete telefonica. Tali funzioni sono accessibili solo se il gestore di rete telefonica offre i servizi descritti. Per maggiori dettagli a riguardo, rivolgersi al proprio gestore di rete telefonica.

Visualizzazione del numero di chiamata (CLIP²)



La visualizzazione del numero di chiamata è un servizio aggiuntivo offerto dal proprio gestore di rete telefonica. Si consiglia di rivolgersi al proprio gestore di rete telefonica per ricevere ulteriori informazioni a riguardo.

Con questa funzione il numero telefonico del chiamante è visualizzato non appena il telefono squilla. Il numero di chiamata non è comunque visualizzato e memorizzato nell'elenco chiamate qualora l'interlocutore abbia disattivato la trasmissione del proprio numero di chiamata. Ciò è peraltro indicato da un rispettivo messaggio che appare sul display.

¹ **VMWI**: Visual Message Waiting Indication

² **CLIP**: Calling Line Identification Presentation

8 Struttura di menu

Menu principale

Nel menu principale si giunge premendo il tasto softkey **Menu**. La procedura da seguire per scorrere all'interno del menu ed eseguire immissioni è riportata al capitolo 4.

SMS¹

Scrivi SMS	Testo:	Numero	Invio SMS	
			Salva SMS	
			Cancella SMS	
In arrivo	Voce 1	Opz	Rispondi SMS	Usa testo?
	Voce 2		Cancella SMS	
	Voce ...		Chiamare numero	
			Salva numero	Nome:
Lista inviati	Voce 1	Opz	Invio SMS	Numero
	Voce 2		Modifica SMS	
	Voce ...		Cancella SMS	
Impostaz. SMS	Centro SMS		Centro SMS 1 - 4	Numero
	Sel. cent. invio		Centro invio 1 - 4	
	Allarme SMS		OFF	
			ON	

¹ Ulteriori informazioni sui messaggi di testo SMS ☞ pagina 116.

Struttura di menu

Info Con il tasto info si giunge direttamente in questo menu.

In arrivo	Segreteria tel. (-)	(solo con messaggi nuovi)
	Lista chiam. (-)	(solo con chiamate nuove)
	SMS (-)	(solo con SMS nuovi)
SMS	☞ pagina 108	
Lista chiam.	☞ pagina 113	
Servizio info	Voce 1	Opz Modifica voce Numero Nome:
	Voce ...	Cancella voce Cancellare?

Display

Sfondo	Sfondo 1	(wallpaper in modalità di stand-by)
	Sfondo 2	
	Sfondo 3	
	Sfondo 4	
	Sfondo OFF	
Nome portatile	Nome:	
Contr. display	Contrasto 1 - 8	
Schema colore	azzurro / rosa	
	verde / giallo	
	viola / marrone	
Luce ON/OFF	OFF	(illuminazione della tastiera)
	ON	
Modalità dimmer	OFF	(Ulteriori informazioni sulla "Modalità dimmer" ☞ pagina 115)
	Sempre ON	
	Per 10 minuti	

Struttura di menu

Toni

Suoneria	Volume chiam.	OFF
		Volume chiam.1 - 5
		Volume chiam. ^ 1
	Mel. chiam.	Mel. chiam. 1 - 15
Toni allarme	Tono tasti	OFF
		ON
	Avviso batteria	OFF
		ON
	Portata!	OFF
		ON

Impostazioni

Impostaz. port.	Chiamata diretta	Inserisci PIN ² ▶
	▶ Baby Call On	Numero
	Baby Call Off	
	Selezione base	Base A
		Base ...
	Risposta autom.	OFF
		ON
	No. emergenza ▶	
	▶ No. emergenza 1	Numero
	No. emergenza ...	
	Riprist. config.	Ripristina?
	Lingua	Deutsch
		Français / Italiano

¹ Con questa impostazione il volume aumenta ad ogni ulteriore segnalazione acustica di chiamata.

² Il codice PIN è impostato in fabbrica su "0000".

Struttura di menu

Impostaz. base	Suoneria	Volume chiam.	OFF
			Volume chiam. 1 -5
		Mel. chiam.	Mel. chiam. 1 - 5
	Proc. selezione	Selezione DTMF	
		Selezione DC	
	Segn. centrale	Numero	
	Modifica PIN ¹	Vecchio PIN	Nuovo PIN: ▶
		▶	Ripeti PIN:
	Riprist. config.	Ripristina?	Inserisci PIN ▶
		▶	Attendere prego!
Data / Ora	Data:	Tempo:	
Tempo flash	Flash 1 - 8		
Registra port.	Base A * ²	Inserisci PIN	Cerca base!
	Base B		
	Base C		
	Base D		
Disconn. port.	Inserisci PIN	Portatile 1	Disconn. port.?
		Portatile ...	

¹ Il codice PIN è impostato in fabbrica su "0000".

² Per la registrazione delle stazioni base sono disponibili 4 posizioni di memoria. Posizioni di memoria contrassegnate da un asterisco risultano già occupate. Indicando in sede di selezione una posizione di memoria già occupata, la vecchia registrazione presente sulla posizione di memoria in questione è sovrascritta.



Struttura di menu

Segreteria tel. ¹

Senti messaggio			
Cancella tutto		Cancellare?	
Risposta ON/OFF		OFF	
		ON	
Impost. segret.		Mod. risposta	Con registr.
		Senza registr.	
Annuncio		Reg. annuncio	Con registr.
			Senza registr.
		Senti annuncio	Con registr.
			Senza registr.
Tempo registraz.		30 / 60 / 120 s	
		Illimitato	
Ritardo risposta		Mod. risparmio	
		2 squilli	
		4 squilli	
		6 squilli	
		8 squilli	
Mod. PIN remoto		Vecchio PIN	Nuovo PIN: ◆
		◆ Ripeti PIN:	
Registra memo			

¹ Ulteriori informazioni sulla segreteria telefonica ➤ pagina 99.

Rubrica telefonica

Nella rubrica telefonica si giunge premendo il tasto .

Rubrica tel.

Voce 1	Opz	Nuova voce	Numero	Nome: ¹
Voce 2		Modifica voce	Numero	Nome: ¹
Voce ...		Cancella voce	Cancellare?	
		Cancella tutti	Cancellare?	

Elenco chiamate

Nell'elenco chiamate si giunge premendo il tasto .

Lista chiam. ²

Voce 1	Opz	Cancella voce	Cancellare?
Voce 2		Cancella lista	Cancellare?
Voce ...		Dettagli	
		Salva numero	Nome: ¹

¹ I tasti numerici riportano altresì delle lettere. Premendo ripetutamente il relativo tasto, si ha modo di selezionare lettere, cifre e caratteri speciali. Con il tasto asterisco è possibile passare da lettere maiuscole a lettere minuscole o all'immissione di cifre.

² Per visualizzare e memorizzare numeri di chiamata in elenchi chiamate è necessaria la visualizzazione del numero di chiamata (**CLIP**³). La visualizzazione del numero di chiamata è un servizio addizionale offerto dal proprio gestore di rete telefonica. Si consiglia di rivolgersi al proprio gestore di rete telefonica per ricevere maggiori informazioni a riguardo. Ulteriori informazioni sulla visualizzazione del numero di chiamata ➔ pagina 107.

³ **CLIP**: Calling Line Identification Presentation

9 Funzioni speciali

Accettazione automatica di chiamata (Accettazione diretta)

L'attivazione di questa funzione consente di ricevere automaticamente una chiamata estraendo semplicemente l'unità portatile dalla stazione base. Impostare l'accettazione diretta ☞ pagina 110.

Procedura di selezione

Il telefono è in grado di operare sia con impianti di commutazione interni analogici (procedura di selezione a impulsi) sia con impianti telefonici digitali (procedura di selezione a toni). Impostare la procedura di selezione ☞ pagina 111.

Selezione a frequenza temporanea

Qualora fosse possibile utilizzare il telefono soltanto con la procedura di selezione a impulsi, non sarà necessario rinunciare ai vantaggi della procedura di selezione a toni (per es. interrogazione della segreteria telefonica dalla rete telefonica). Durante una chiamata in corso è infatti possibile passare temporaneamente alla procedura di selezione a frequenza.

2 sec

Tenere premuto con chiamata in corso per la durata indicata

Alla fine della telefonata il telefono ritorna di nuovo automaticamente alla procedura di selezione a impulsi.

Chiamata diretta

La funzione consente di memorizzare un determinato numero di chiamata selezionato automaticamente non appena si preme un tasto qualsiasi del telefono (tranne tasto softkey **Opz**). Attivare la chiamata diretta ☞ pagina 110.

, o

,

Disattivare la chiamata diretta

Numeri di chiamata d'emergenza

Sull'unità portatile è possibile memorizzare 4 numeri di chiamata d'emergenza. Questi numeri di chiamata d'emergenza sono selezionabili anche con blocco tastiera inserito. Salvare numeri di chiamata d'emergenza  pagina 110.

Modalità dimmer

Impostazione	Effetti
OFF	L'illuminazione del display si spegne dopo 30 secondi.
Sempre ON	L'illuminazione del display è ridotta dopo 30 secondi e rimane inserita.
Per 10 minuti	L'illuminazione del display è ridotta dopo 30 secondi e si spegne trascorsi 10 minuti.

10 SMS

Requisiti SMS

L'allacciamento telefonico deve essere abilitato alla caratteristica funzionale **CLIP**¹. Assicurarsi presso il proprio gestore di rete telefonica, che l'allacciamento telefonico sia abilitato alla caratteristica funzionale richiesta. Per poter usufruire del servizio **SMS**² può rendersi necessaria la precedente abilitazione al servizio presso il proprio gestore di rete telefonica.

- L'invio di SMS non è possibile da qualsiasi tipo di impianto telefonico interno.



Se si desidera inviare SMS da un impianto telefonico interno, inserire sull'unità portatile prima del numero del centro di servizio la cifra per il segnale di linea libera richiesto dall'impianto telefonico interno.

- In caso di collegamenti in call by call, l'invio di un SMS al momento non è ancora possibile.
- L'invio di messaggi SMS è soggetto a costi supplementari.
- Se il ricevitore non utilizza un servizio SMS o se il rispettivo telefono non è abilitato alla ricezione di SMS, il messaggio SMS è inoltrato sotto forma di messaggio vocale.
- Il calcolo delle rispettive spese avviene da parte del proprio gestore di rete telefonica.

Centro di servizi SMS

La distribuzione di messaggi SMS avviene attraverso un centro di servizi. Per inviare messaggi di testo SMS è necessario programmare il numero del centro di servizi nella propria unità portatile  pagina 108. Si prega di richiedere presso l'offerente scelto il numero del centro di servizi necessario e la procedura da seguire per l'abilitazione al servizio SMS.



Il presente telefono è già predisposto per l'invio di messaggi di testo SMS. Nell'unità portatile sono stati infatti già programmati i numeri del centro di servizi. Attivare il centro di servizio desiderato nel menu SMS.  pagina 109

¹ **CLIP**: Calling Line Identification Presentation

² **SMS**: Short Message Service

Centro di servizio 1	Centro di servizio 2
Swisscom: 0622100000	Cablecom: 0435375370
Centro di servizio 3	Centro di servizio 4
vuoto	vuoto

Immissione di testo

L'immissione di testo viene eseguita utilizzando le lettere indicate sui tasti numerici del telefono. Premendo ripetutamente il relativo tasto, si ha modo di selezionare lettere, cifre e caratteri speciali.

0 , 1 o #	Inserire caratteri speciali
*	Passare da lettere maiuscole a lettere minuscole o all'immissione di cifre
Canc	Cancellare l'ultima posizione
2 sec Canc	Cancella tutto

Segnale di avviso SMS (allarme)

La ricezione di nuovi messaggi di testo SMS è segnalata da un segnale di avviso acustico. Questo segnale può essere attivato e disattivato. Attivare o disattivare il segnale di avviso ☞ pagina 109.

11 Ampliare il sistema telefonico

La funzione standard internazionale **GAP**¹ regola la compatibilità di unità portatili e stazioni base di costruttori diversi. Ciò consente di integrare apparecchi SWI-TEL e apparecchi di altri costruttori all'interno di un unico sistema telefonico. Può comunque anche verificarsi la mancata disponibilità di alcune funzioni.

Maggior numero di unità portatili

È possibile registrare in tutto 5 unità portatili alla propria stazione base.

Registrazione di unità portatili

Prima di registrare un'unità portatile è necessario passare con la stazione base alla modalità registrazione.

10 sec  , 

Avviare la modalità registrazione

Procedere a questo punto con la registrazione dell'unità portatile  pagina 111.

Utilizzare per la selezione il codice PIN attualmente impostato  pagina 111.

Una volta eseguita la selezione, all'unità portatile è assegnato un numero di chiamata interno. Questo numero di chiamata interno è visualizzato sul display.



Per registrare unità portatili di altri costruttori, leggere prima le rispettive istruzioni per l'uso.

Deselezione di unità portatili





Ogni unità portatile è in grado di deselezionare se stessa o altre unità dalla presente stazione base. In tal caso, nel display dell'unità portatile deselezionata è visualizzata l'indicazione "Cerca base!".

Deselezione di unità portatili  pagina 111.

Maggior numero di stazioni base

La portata della propria unità portatile può essere aumentata registrando l'apparecchio ad un numero maggiore di stazioni base. Il telefono può risultare registrato contemporaneamente a 4 stazioni base differenti. Ogni stazione base necessita di una propria presa telefonica. Si può trattare di allacciamenti con lo stesso o differente numero di chiamata.



Passare con le altre stazioni base in modalità registrazione. Registrare l'unità portatile  pagina 111. Nel menu "Selezione base" è possibile selezionare la stazione base dalla quale si desiderano compiere le telefonate  pagina 110.

¹ **GAP: Generic Access Profile** = Standard per l'interazione di unità portatili con stazioni base di altri costruttori.

12 In caso di problemi

In presenza di problemi con il telefono, seguire le indicazioni riportate qui di seguito. Rivolgersi al proprio rivenditore in caso di problemi tecnici o di interventi nell'ambito della garanzia. Il periodo di garanzia riscopre 2 anni.

Domande e risposte

Domande	Risposte
Non è possibile collegarsi alla stazione base.	<ul style="list-style-type: none">- Verificare se la registrazione alla stazione base è stata eseguita con il codice PIN corretto  pagina 111.
Non è possibile condurre una chiamata telefonica.	<ul style="list-style-type: none">- Il telefono non è collegato correttamente oppure presenta un guasto. Utilizzare esclusivamente il cavo di collegamento telefonico fornito.- Provare con un altro telefono se l'allacciamento telefonico in questione è funzionante.- L'alimentatore di rete non è inserito oppure si è in presenza di una caduta di tensione totale.- Le batterie ricaricabili sono scariche o difettose.- La distanza dalla stazione base è troppo grande.- Impostazione errata della procedura di selezione  pagina 111.
Collegamento disturbato, si interrompe.	<ul style="list-style-type: none">- La distanza dalla stazione base è troppo grande.- Luogo di installazione della stazione base errato.
Il sistema non reagisce più.	<ul style="list-style-type: none">- Ripristinare le impostazioni di default per tutte le funzioni  pagina 121.- Estrarre brevemente l'alimentatore di rete dalla presa di corrente.- Rimuovere brevemente le batterie ricaricabili dall'unità portatile.

In caso di problemi

Domande	Risposte
Le batterie ricaricabili si scaricano piuttosto subito.	<ul style="list-style-type: none">- Le batterie sono scariche o difettose.- Riporre l'unità portatile correttamente nella stazione base. Pulire le superfici di contatto di unità portatile e stazione base con un panno morbido e asciutto.- Posizionare l'unità portatile per la durata di 16 ore nella stazione base.
La visualizzazione del numero di chiamata (CLIP ¹) non funziona	<ul style="list-style-type: none">- La visualizzazione del numero di chiamata è un servizio opzionale offerto dal proprio gestore di rete telefonica. Per maggiori dettagli a riguardo, rivolgersi al proprio gestore di rete telefonica.- Il chiamante ha disattivato la trasmissione del proprio numero di chiamata.
La segreteria telefonica non registra più nessun messaggio / nessun promemoria	<ul style="list-style-type: none">- Assicurarsi che la segreteria telefonica sia collegata e attivata correttamente.- Verificare che la memoria della segreteria telefonica non sia piena. Cancellare eventualmente dei messaggi dalla memoria ☞ pagina 102.
Non è possibile compiere un'interrogazione a distanza.	<ul style="list-style-type: none">- Verificare se è stato utilizzato il codice di sicurezza corretto per l'interrogazione a distanza. ☞ pagina 104- Il telefono utilizzato per compiere l'interrogazione a distanza deve passare alla procedura di selezione a toni.

¹ CLIP: Calling Line Identification Presentation

13 Specifiche tecniche

Specifiche tecniche

Caratteristica	Valore
Standard	DECT-GAP¹
Alimentazione elettrica (stazione base)	Ingresso: 220/230 V, 50 Hz Uscita: 6 V, 600 mA
Portata	in campo aperto: ca. 300 m in ambienti chiusi: ca. 50 m
Autonomia di stand-by	fino a 100 ore
Autonomia di chiamata	fino a 10 ore
Batterie ricaricabili	2 x 1.2 V, tipo: AAA
Procedura di selezione	Procedura di selezione a toni Procedura di selezione a impulsi
Temperatura ambiente consentita	da 10°C a 30°C
Umidità atmosferica relativa consentita	da 20% a 75%
Funzione flash	80 ms, 100 ms, 120 ms, 180 ms, 250 ms, 300 ms, 600 ms, 800 ms

Impostazioni di default

Unità portatile

Ripristinare la configurazione iniziale  pagina 110

Lingua:	Tedesco	Numero di chiamata d'emergenza 1:	vuoto
Melodia di suoneria:	6	Numero di chiamata d'emergenza 2:	vuoto
Volume di suoneria:	5	Numero di chiamata d'emergenza 3:	vuoto
Volume del ricevitore:	3	Numero di chiamata d'emergenza 4:	vuoto

¹ **DECT**: Digitally Enhanced Cordless Telecommunication = Standard per telefoni senza cavo.

GAP: Generic Access Profile = Standard per l'interazione di unità portatili con stazioni base di altri costruttori.

Specifiche tecniche

Volume del dispositivo vivavoce: 3	Suono tasti: ON
Rubrica telefonica: vuoto	Nome UP: DFT727
Elenco chiamate: vuoto	SMS: vuoto
Ripetizione di chiamata: vuoto	Segnale di avviso SMS: ON
Funzione bebé: OFF/vuoto	Accettazione diretta: ON
Numero di accesso alla rete esterna: vuoto	Contrasto di display: 4
Blocco tastiera: OFF	Colore di menu: Blu
Segnale di avviso batteria: ON	Illuminazione tasti: ON
Segnale di avviso portata: ON	Wallpaper: Cielo
Modalità dimmer: Per 10 minuti	

Stazione base

Ripristinare la configurazione iniziale  pagina 111

Melodia di suoneria: 1	Tempo flash: 100 ms
Volume di suoneria: 5	Procedura di selezione: Selez. a toni
Rubrica telefonica VIP: vuoto	PIN: 0000

Segreteria telefonica

Ritardo: 4 segnalazioni di chiamata	Modalità annuncio con registrazione
Segreteria telefonica: ON	Volume: 3

Dichiarazione di conformità

Questo apparecchio risponde a quanto disposto dalla Direttiva UE: 1999/5/CE Direttiva concernente le apparecchiature radio, le apparecchiature terminali di telecomunicazioni e il reciproco riconoscimento della loro conformità. La conformità con la Direttiva di cui sopra viene confermata dal marchio CE applicato sull'apparecchio.

La dichiarazione di conformità integrale è riportata sul retro del presente manuale d'istruzioni per l'uso.



14 Consigli per la cura / Garanzia

Consigli per la cura

- Pulire le superfici degli apparecchi con un panno morbido e antipilling.
- Non utilizzare mai detersivi o solventi.

Garanzia

Gli apparecchi SWITEL sono costruiti e collaudati in osservanza dei processi di produzione più moderni. L'impiego di materiali selezionati e tecnologie altamente sviluppate sono garanti di una perfetta funzionalità e lunga durata in vita. La garanzia non viene considerata esecutiva qualora la causa del malfunzionamento dell'apparecchio è dovuta al gestore della rete telefonica oppure se questa è da attribuirsi ad un impianto telefonico interno interposto. La garanzia non si estende a batterie, accumulatori o batterie ricaricabili utilizzati all'interno degli apparecchi. Il periodo di garanzia è di 24 mesi a partire dalla data di acquisto.

Entro il periodo di garanzia si procederà all'eliminazione gratuita di tutti i guasti dovuti a difetti di materiale o produzione. Il diritto di garanzia cessa in caso di interventi da parte dell'acquirente o di terzi. La presente garanzia non ricopre danni dovuti all'uso o all'esercizio non conformi a quanto previsto, a montaggio o conservazione errati, a collegamento o installazione impropri così come a forza maggiore o a qualsiasi altro influsso esterno. In qualità di produttore ci riserviamo il diritto, in caso di reclami, di riparare o sostituire le parti difettose o di rimpiazzare l'apparecchio. Parti sostituite o apparecchi rimpiazzati divengono di nostra proprietà. Sono esclusi diritti di risarcimento per danni qualora non siano dovuti a intenzione o colpa grave del costruttore.

Nel caso in cui il presente apparecchio dovesse ciò nonostante presentare un difetto durante il periodo di garanzia, si prega di rivolgersi esclusivamente al negozio di rivendita dell'apparecchio SWITEL assieme al relativo scontrino di acquisto. In base a quanto riportato nelle presenti disposizioni, tutti i diritti di garanzia dovranno essere rivendicati nei confronti del rivenditore autorizzato. Decorso il termine di due anni dalla data di acquisto e consegna dei nostri prodotti non sarà più possibile fare valere alcun diritto di garanzia.

15 Indice alfabetico

A

- Accettazione automatica di chiamata, 114
- Accettazione diretta, 114
- Allarme SMS, 117
- Allargare il sistema telefonico, 118
- Ascoltare messaggi, 102
- Attivare / Disattivare la segreteria telefonica, 99
- Attivare e disattivare l'unità portatile, 98
- Attivazione a distanza della segreteria telefonica, 105

B

- Blocco tastiera, 98

C

- Cancellare degli annunci, 101
- Cancellare messaggi, 102
- Cancellare promemoria, 102
- Cancellare tutti i messaggi / promemoria, 103
- Caricare le batterie, 89
- Centro di servizi SMS, 116
- Chiamata diretta, 114
- Chiamata in attesa, 97
- Cifra per il segnale dalla centrale, 106
- Codice di sicurezza interrogazione a distanza, 104
- Collegare la stazione base, 88
- Come funziona il mio telefono?, 91
- Compiere chiamate a conferenza, 97
- Compiere chiamate interne, 96
- Compiere telefonate, 95
- Concatenare e trasmettere numeri, 96
- Concludere una chiamata, 95
- Condurre chiamate interne, 96
- Consigli per la cura, 123
- Contenuto della confezione, 88
- Correzione di errori, 119
- Creare voci nella rubrica telefonica, 94

D

- Deselezione di unità portatili, 118
- Dichiarazione di conformità, 122
- Domande e risposte, 119
- Durata di conversazione, 97
- Durata di registrazione massima, 99

E

- Elementi di comando, 90

F

- Funzione vivavoce, 98
- Funzioni a tasti dell'interrogazione a distanza, 105
- Funzioni speciali, 114

G

- Garanzia, 123

I

- Immissione di testo, 117
- Impianti telefonici interni, 106
- Impostare data e ora della segreteria telefonica, 99
- Impostare il numero di segnalazioni di chiamata, 100
- Impostare il volume della segreteria telefonica, 100
- Impostazioni di default, 121
- In caso di problemi, 119
- Indicazioni di sicurezza, 86
- Inoltro interno di chiamate esterne, 96
- Inserire le batterie ricaricabili, 89
- Inserire manualmente la pausa di selezione, 106
- Intercettare messaggi in arrivo, 100
- Interrogazione a distanza, 104

M

- Maggior numero di stazioni base, 118
- Maggior numero di unità portatili, 118
- Melodia di suoneria, 98
- Menu principale, 108
- Mettere in funzione il telefono, 88
- Modalità dimmer, 109, 115
- Modalità risparmio, 100
- Modi di scrittura, 91

N

- Numeri di chiamata d'emergenza, 115

P

- Paging, 98
- Pausa di selezione automatica, 106
- Procedura di selezione, 111, 114

R

- Rappresentazioni, 91
- Registrare degli annunci, 101
- Registrare dei promemoria, 102
- Registrazione di unità portatili, 118
- Requisiti SMS, 116
- Ricerca dell'unità portatile, 98
- Ricevere una chiamata, 95
- Ripetizione di selezione, 95
- Riprendere una chiamata, 100
- Riprodurre promemoria, 102
- Riscontro, 97
- Riselezionare chiamate ricevute, 95
- Ritardo, 100
- Rubrica telefonica, 113

S

- Segnale di avviso SMS, 117
- Segreteria telefonica, 99
- Segreteria telefonica integrata nella rete telefonica, 107
- Selezionare la modalità di annuncio, 101
- Selezionare numeri dalla rubrica telefonica, 95
- Selezione a frequenza temporanea, 114
- Selezione a impulsi, 111
- Selezione a toni (DTMF), 111
- Servizi aggiuntivi, 106
- Silenziamento del microfono, 98
- Simboli sul display, 91
- Solo annuncio, 101
- Specifiche tecniche, 121
- Stato di carica delle batterie, 89
- Struttura di menu, 108

T

- Tasti di navigazione, 93
- Tasto R e servizi aggiuntivi, 106
- Tasto R in impianti telefonici interni, 106
- Telefonare, 95
- Tempo flash, 111

V

- Visualizzazione del numero di chiamata, 107
- VMWI, 107
- Volume del ricevitore, 97



Contents

1	Safety Information	127
2	Putting the Telephone into Operation	129
3	Operating Elements	131
4	Operating the Telephone	132
5	Telephoning	136
6	Answering Machine	140
7	PABX/ Supplementary Services	147
8	Menu Structure	149
9	Special Functions	155
10	SMS	157
11	Expanding the Telephone System	159
12	In the Case of Problems	160
13	Technical Properties	162
14	Maintenance / Guarantee	164
15	Index	165

1 Safety Information

Please read this operating instruction manual thoroughly.

Intended use

The telephone is suitable for telephoning within a public telephone network system. Any other use is considered unintended use. Unauthorised modification or reconstruction is not permitted. Under no circumstances open the device or complete any repair work yourself.

Installation location

Prevent excessive exposure to smoke, dust, vibration, chemicals, moisture, heat and direct sunlight.

Do not use the handset in potentially explosive areas.

Power supply



Attention: Only use the power adapter plug supplied because other power supplies could damage the telephone. Ensure access to the power adapter plug is not obstructed by furniture or such.

Rechargeable batteries



Attention: Do not throw batteries into a fire or immerse them in water.

Power failure

The telephone cannot be used to make calls in the event of a power failure. Always keep a cord connected telephone which operates without an external power supply available in case of emergency situations.

Medical equipment



Attention: Never use the telephone in the vicinity of medical equipment. Effects on such equipment cannot be fully ruled out.

DECT¹ DECT telephones can cause an unpleasant humming sound in hearing aids.

¹ **DECT:** Digital Enhanced Cordless Telecommunication = Standard for cordless telephones.

Safety Information

Disposal

If your device has come to the end of its service life, bring it to a collection point provided by your local public waste authorities (e.g. recycling center). The adjacent symbol indicates that the old device must be disposed of separate from domestic waste. According to laws on the disposal of electronic and electrical devices, owners are obliged to dispose of old **electronic and electrical devices** in a separate waste container.

Batteries must be disposed of at the point of sale or at appropriate collection points provided by the public waste authorities. **Packaging materials** must be disposed of according to local regulations.



Putting the Telephone into Operation

2 Putting the Telephone into Operation

Safety information



Attention: It is essential to read the Safety Information in Chapter 1 before starting up.

Checking the contents of the package

The package contains:

- a base station with power adapter
- a telephone connection cable plug
- a handset
- two rechargeable batteries
- an operating manual

Connecting the base station



Attention: Position the base station at least 1 m away from other electronic devices, otherwise there is a risk of mutual disturbance.

Connect the base station as illustrated in the diagram. For reasons of safety, only use the power adapter plug (6V, 600mA) and telephone connection cable supplied.

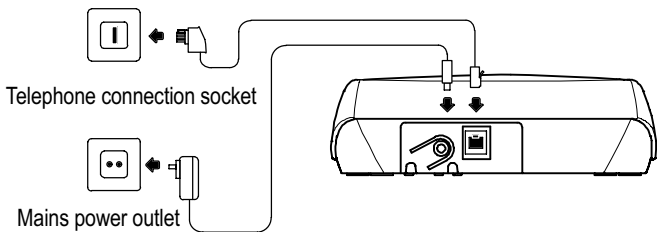

Putting the Telephone into Operation

Inserting the batteries

Insert the batteries in the open battery compartment. Only use batteries of the type AAA Ni-MH 1.2 V. Pay attention to correct polarity. Close the battery compartment.

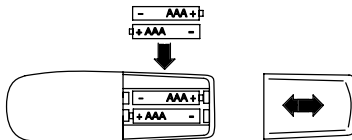

Charging the batteries

Before the handset is used for the first time, insert it in the base station/ for at least 16 hours. When the handset is inserted in the base station properly, you will hear a confirmation signal. The handset warms up during the charging process. This is normal and does not represent a risk. Do not charge the handset with charging units from other manufacturers.

The current **battery charge status** is indicated in the display:



Full



Half empty



Weak



Empty

Setting the time and date on the handset

The time and date are set via the menu. Refer to Page 152 for the sequence of option selections.

Private branch exchanges

The information on Page 147 explains how to install your telephone in a private branch exchange.

Setting the weekday and time on the answering machine

The weekday and time are set automatically on the answering machine via the handset.

3 Operating Elements

Handset

- 1 Scroll upwards / Call log
- 2 Softkey Right button
- 3 Phone book
- 4 R-button (Flash)
- 5 Scroll downwards
- 6 On-hook / Switch handset on/off
- 7 Hash button / Key lock
- 8 Switch ringing tone off / Temporary tone dialling
- 9 Off-hook (Call)
- 10 Handsfree mode
- 11 Move back / Muting function
- 12 Softkey Left button
- 13 Menu button "Info"

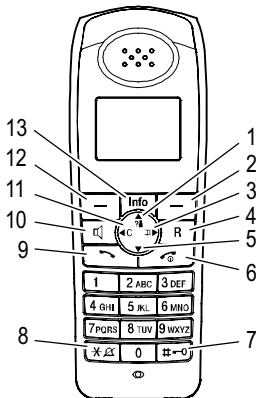

Base station (answering machine)

- 1 Paging button (locate handset)
- 2 Answering machine on/off
- 3 LED Call indicator
- 4 Skip back
- 5 Delete
- 6 Play / Stop
- 7 LED Charge control lamp
- 8 Skip forwards
- 9 Volume +
- 10 Volume -

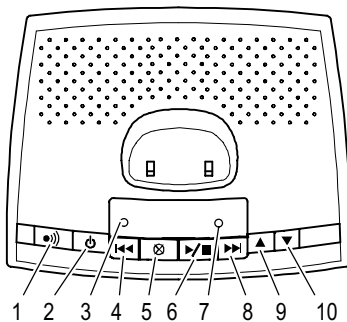











The buttons in this operating manual are depicted with a uniform contour. Variations in the symbols on the telephone buttons compared to those depicted here are possible.







Operating the Telephone

4 Operating the Telephone



















Display and notation of operation sequences

	Enter digits or letters
	Press the button depicted briefly
2 sec 	Press the button depicted for 2 seconds
	Handset rings
	Base station rings
	Remove the handset from the base station
	Place the handset in the base station
	Text or icon in the display
	Press the softkey,  Page 134

Icons in the display

Display	Description
	On: The connection to the base station is good. Warning tone: The connection is being interrupted. Off: The connection has been interrupted. Move towards the base station.
	Handsfree mode is activated.  Page 139
	On: A call is currently being made. Flashing: The telephone is ringing.  Page 136
	The ringing tone has been switched off.  Page 139

Operating the Telephone

Display	Description
	The microphone is deactivated (muted).  Page 139
 and Tastensperre	The key lock function is activated.  Page 139
	On: Battery charge capacity indicator. Run-through: The batteries are being charged.  Page 130
DFT727	Name of the telephone.  Page 159
1	Internally assigned call number of the handset.  Page 159
01.12 13:26	Display of date and time.  Page 152
 and Neue Anrufe	New calls have been registered in the call log  Pages 154 and 148. In addition a red LED behind the “Info” button flashes.
 and Neue SMS	A new SMS ¹ message has been recorded.  Pages 149 and 157
	Answering machine provided by the telephone network. VMWI ² - Optional service offered by the telephone network provider.  Page 148
	The answering machine is activated.  Pages 153 and 157
	A new message has been recorded (TAM).  Pages 153 and 157

¹ **SMS**: Short **M**essage **S**ervice

² **VMWI**: Visual **M**essage **W**aiting **I**ndication

Operating the Telephone

Navigation buttons

All descriptions in this operating manual assume that the handset is in Standby mode. The handset is in Standby mode after pressing the  button.





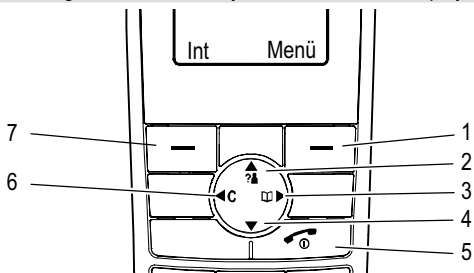

The softkeys (1) and (7) are assigned different functions in the different menus. The function buttons are always referred to in this manual according to the texts directly above them in the display.



Button	In Standby mode	In Menu
1	- Open the main menu	- Opens the menu displayed
2	- Open the call log	- Scroll upwards - Change the settings
3	- Open the phone book	- Scroll to the right
4		- Scroll downwards - Change the settings
5	- Switch handset on/off	- Cancel programming and saving processes
6		- Scroll to the left - Move one level back
7	- Internal call	- Move one level back

Navigating in the menu

All the functions can be accessed via the various menus. Refer to the menu structure to find how to access the respective functions,  Page 149



Menü	Open the main menu
▲ or ▼, ◀ or ▶	Move to and select the required submenu
Ok	Open the submenu
▲ or ▼	Move to and select the required function
Ok	Open the function
▲ or ▼	Move to and select the required setting
	Enter digits or letters using the relevant digit keys
Ok or Spei	Confirm or store the entry
 or <<	Move one level back
	Cancel programming and saving processes and return to Standby mode



Every process is automatically cancelled if there is no input within 30 seconds.

Creating phone book entries - example

The way in which to navigate through the menus and enter data is explained by means of the example **Creating phone book entries**. Proceed as in this example for all the settings.

	Open the phone book
Opt	Open the Options menu
▲ or ▼	
Neuer Eintrag, Ok	Select function and confirm
Nummer:  Ok	Enter the number (max. 24 digits) and confirm
Name:  Spei	Enter the name (max. 15 characters) and store

Telephoning

5 Telephoning

Taking a call



Take the call

Ending a call



End the call

Making a call



Enter the phone number (max. 24 digits)

Lösch

Delete the last digit if incorrect



Dial the phone number



It is also possible to press the Off-hook (Call) button for 2 seconds to obtain the dialling tone. The phone number then entered is dialled immediately. It is not possible to correct wrong digits individually using this dialling procedure.

Redialling

The telephone stores the last 20 numbers dialled in a redialling list.



Open the redialling list



Select an entry and dial the number

Calls log

The telephone stores the numbers of the last 30 calls received in a call log.



Open the calls log



Select an entry and dial the number

Dialling phone numbers from the phone book

Phone numbers must have been stored in the phone book for this function.

Pages 135 and 154





Open the phone book



Select an entry and dial the number

Chain dialling



The chain dialling function is used in more complex telephone services, e.g. for telephone banking, call-by-call or calling card procedures. Several numbers stored in the phone book can be transmitted. It is also possible to combine numbers for transfer from the phone book with numbers entered manually. Numbers stored in the phone book can be chained and transmitted as required.



-
- | | |
|--|---|
|  | Open the phone book |
|  or  , Ok | Select the phone book entry and transfer the number |

Internal calls



Making internal calls



There must be two or more handsets (HS1, HS2, ...) registered on a base station in order to make internal calls free of charge. Further information,  Page 159



-
- | | |
|--|---|
| HS1: Int ,  or  | |
| e.g. Mobilteil 2 , Ok | Dial the internal call number of the handset required |

-
- | | |
|--|---|
| HS2:  | Take the internal call on the other handset |
| HS1/HS2:  | End the internal call |

Transferring external calls internally

-
- | | |
|--|--|
| HS1: Int ,  or  | |
| e.g. Mobilteil 2 , Ok | Dial the internal call number during the conversation with the external caller |

-
- | | |
|--|---|
| HS2:  | Take the internal call on the other handset |
| HS1:  | Transfer the call |

 If the handset called does not answer, take the external call back by pressing the  button.

Telephoning

Holding a call / brokering

While a call is in progress, it is possible to dial another handset in order to consult with someone. The external caller is put on hold while you converse with the second, internal person called. You can switch between the callers as often as necessary.

HS1: Int ,  or 

e.g. Mobilteil 2 , Ok

Dial the internal call number during the conversation with the external caller

HS2: 

Take the internal call on the other handset

HS1: Makel

Change back and forth between the callers

Conference calls

An external call can be transferred to another internal handset for a conference call.

HS1: Int ,  or 

e.g. Mobilteil 2 , Ok

Dial the internal call number during the conversation with the external caller

HS2: 

Take the internal call on the other handset

HS1: Konf

Start the conference



At this point, you can switch between the two callers as necessary and then back to the conference.

HS1/HS2: 

The conference is terminated by one of the internal handset users ending the call

Adjusting the receiver volume

The volume can be adjusted to one of 5 settings during a call.

 or 

Select the required volume

Talk time display

The duration of a received call is displayed in hours, minutes and seconds during the call.

Handsfree

This function is used to listen to the caller via the loudspeaker.



Activate handsfree mode



Deactivate handsfree mode

Muting the microphone in the handset

The microphone in the handset can be activated and deactivated during a telephone conversation.



Deactivate the microphone (muting function activated)



Activate the microphone

Key lock

3 sec

Activate the key lock function



Incoming calls can still be taken in the normal way even when the key lock function is activated.

3 sec

Deactivate the key lock function

Handset ringing melody

The ringing melody on the handset can be switched off.

3 sec

Deactivate the ringing melody



The ringing tone setting on the base station remains unaffected.

3 sec

Activate the ringing melody

Searching for the handset (Paging)

If you have mislaid your handset, you can locate it again with the aid of a search tone.

Activate the search tone

or

End the search tone

Switching the handset on and off

You can switch the handset off in order to save the batteries.

2 sec MT ausschalten?

Ja or Nein

Confirm or cancel the function

2 sec

Switch the handset on

6 Answering Machine

All the functions provided on the answering machine (TAM) can be operated via the handset. Some functions can also be controlled directly on the base station.



Your answering machine is equipped with a vocal operator guidance. Observe the instructions and information provided.

Proceed as follows to open the answering machine's Answer Settings menu:

Menü	Open the main menu
◀ or ▶	
Anrufbeantworter , Ok	Open the Answer Machine menu
◀ or ▶	
AB-Einstellungen , Ok	Open the Answer Settings menu

Setting the weekday and time

The weekday and time of receipt is announced when each message is played back. The weekday and time are set automatically on the answering machine via the handset. Page 152.

Switching the answering machine on/off

Via the base station:

	Switch the answering machine on/off
--	-------------------------------------

Via the handset using the Answer Machine menu:

▲ or ▼	
Anrufb.ein/aus , Ok	Select the function and confirm
▲ or ▼ Aus or	
Ein , Ok	Select the setting and confirm

Maximum recording time

The answering machine can store up to 99 messages. The maximum total recording time is 15 minutes. When there is no memory capacity available to record new messages, no further messages are recorded.

Setting the volume

The volume of the operator guidance can be set to one of 6 levels.

Via the base station:

or Set the volume

Via the handset:

or Set the volume

Setting the number of rings (delay)

You can select from 2 to 8 ringing tones or the **Time Saver** setting for pre-remote access free of charge.

The free pre-remote access function enables you to determine whether new messages have been left on your answering machine.

- If new message have been recorded on your answering machine, your call is taken after 2 rings.
- If no messages have been recorded, the call is taken after 6 rings. Replace the receiver before the 6th ring. No charges are accrued.

Via the Answer Settings menu:

or

, Select the function and confirm

or

e.g.: , Select the setting and confirm

Further information on remote access is provided on  Page 145

Call screening

You can listen-in to the caller without actually taking the call.

Activate the call screening function

Deactivate the call screening function

Taking a call being recorded

It is possible to take a call even if the answering machine has already begun to take it. Recording of the message is stopped in this case.

Take the call

Answering Machine

Selecting the answering mode

The answering machine is provided with two, pre-recorded outgoing messages, OGM 1 and OGM 2. After the "Answer & Record" OGM has been played, the caller can leave a message. The **Answer Only** OGM is purely an announcement after which no message can be left. The pre-recorded outgoing messages can be replaced by ones of your own. When the answering machine's memory is full, the Answer Only message is automatically played.

Via the Answer Settings menu:

▲ or ▼	Antwort-Modus	, Ok	Select the function and confirm
▲ or ▼	Mit Aufzeichng.		
or	Ohne Aufzeichn.	, Ok	Select the setting and confirm

Recording/Controlling/Deleting outgoing messages

Recording outgoing messages

An outgoing message may be up to 2 minutes long.

Via the Answer Settings menu:

▲ or ▼	Ansagetexte	, Ok	Open the Outgoing Message menu
▲ or ▼	Ansage aufnehmen	, Ok	Select the function and confirm
▲ or ▼	Mit Aufzeichng.		
or	Ohne Aufzeichn.	, Ok	Select the outgoing message and confirm
🗨️	Spei		Speak your message and store it

Checking the current outgoing message

Via the Outgoing Message menu:



▲ or ▼	Ansagetext hören	, Ok	Select the function and confirm
▲ or ▼	Mit Aufzeichng.		
or	Ohne Aufzeichn.	, Ok	Select the outgoing message and confirm

Answering Machine

Deleting outgoing messages and returning to pre-recorded messages

After deleting your own outgoing message, the pre-recorded message is automatically reactivated.

Via the Outgoing Message menu:



 or 	
<input type="text" value="Ansagetext hören"/> , <input type="button" value="Ok"/>	Select the function and confirm
<input type="button" value="Löschen"/>	Delete the message during playback

Recording a memo

A memo is a message left for other machine users and can be played in the same way as an incoming message.

Recording the memo

Via the Answer Machine menu:





 or 	
<input type="text" value="Memo aufnehmen"/> , <input type="button" value="Ok"/>	Select the function and confirm
 , <input type="button" value="Spei"/>	Speak your memo and store it

Playing or deleting recorded messages/memos



Play the messages

The recorded messages/memos are played back in the sequence they were received. The weekday and time of recording are announced before the respective message or memo is played back.

Via the base station:

	Play
	Stop playback
	Repeat playback of message
2 x 	Play the previous message
	Play the next message

Via the handset using the Answer Machine menu:

 or 	
<input type="text" value="Nachricht.hören"/> , <input type="button" value="Ok"/>	Open the Play Messages menu

Further operations,  Key function assignment in the Play Messages menu

Answering Machine

Deleting a message

Via the base station:

	Play the message to be deleted
	Delete the message

Via the handset using the Answer Machine menu:

or	
Nachricht.hören ,	Open the Play Messages menu
	Delete the current message

Further operations, Assignment of functions to keys in the Play Messages menu

Key function assignment in the Play Messages menu

Button	Functions
	Play / Stop
,	Play the previous message
	Delete the current message
,	Play the next message

Deleting all messages/memos

All the old messages/memos are deleted. However, new messages/memos not yet played are retained.

Via the base station:

2 sec	Initiate the deleting process
	Confirm the deleting process

Via the handset using the Answer Machine menu:

or	
Alle Nachr.lösch ,	Select the function and confirm
Löschen?	Confirm the deleting process
	or
Löschen?	Cancel the deleting process

Remote access

You can call your answering machine from another telephone to play any new messages or execute other functions. A condition for this is the use of a telephone which implements tone dialling.

PIN code for remote access

The default setting of the security PIN code is "0000". In order to use the remote access function, the default PIN code "0000" must be changed. Remote access is only possible when the PIN code is not set to "0000".

Changing the PIN code

Via the Answer Settings menu:

<input type="button" value="▲"/> or <input type="button" value="▼"/>		
<input type="text" value="Fernabf-PIN änd."/>	<input type="button" value="Ok"/>	Select the function and confirm
<input type="text" value="Alte PIN:"/>	<input type="button" value="OK"/>	Enter the old PIN
<input type="text" value="Neue PIN:"/>	<input type="button" value="OK"/>	Enter the new PIN
<input type="text" value="PIN wiederholen"/>	<input type="button" value="OK"/>	Re-enter the new PIN

Starting remote access

<input type="button" value="☎"/>	Dial your own phone number
<input type="button" value="#"/>	Press the button while the OGM is playing and enter the PIN



If the PIN code entry is incorrect, the OGM is repeated. If the PIN is entered incorrectly three times, the line is automatically disconnected.

You can now execute other functions.  Key function assignment for remote access

Answering Machine

Remote activation of the answering machine



Dial your own phone number



If you forgot to activate your answering machine, your call is taken after the 10th ring.



Press the button while the OGM is playing and enter the PIN



Switch the answering machine on/off

You can now execute other functions. Key function assignment for remote access

Key function assignment for remote access



Remote access is automatically cancelled if there is no input within 8 seconds.

The following table provides an overview of the respective functions assigned to the individual buttons.

Button	Functions
	Play Options menu
	Start playback of all messages
	Start playback of new messages
	Repeat playback of current message
2 x	Play previous message
	Delete current message
	Play next message
	Select the answering mode: "Answer & Record" or "Answer Only"
	Play currently set outgoing message
	Record new outgoing message
	Switch answering machine on/off
	End recording of the outgoing message
	Place the telephone on-hook to end remote access

7 PABX/ Supplementary Services

R button on private branch exchanges

If the telephone is connected to a private branch exchange, all the functions associated with the **R-button**, such as transferring calls and automatic call back, can be used. Please refer to the information in the operating manual enclosed with your private branch exchange with regard to the Flash time to set in order to use these functions. The dealer where you purchased the exchange can provide information as to whether the telephone will work properly with the exchange. Setting the Flash time,  Page 152.

Number for an outside line

In the case of private branch exchanges, it is necessary to dial a specific number in order to obtain the dialling tone for an outside line. This number for an outside line can be stored. When the telephone detects this number preceding a phone number entered, a **dialling pause** is **automatically** inserted after the number. Setting the number for an outside line,  Page 152

Entering a dialling pause manually

It is possible to insert a **dialling pause manually** after the number for an outside line to be able to continue dialling directly without waiting for the dialling tone.

2 sec

Insert dialling pause

After dialling the number for the outside line, the telephone waits 3 seconds before dialling the actual phone number.



The pause can also be entered with the phone numbers in the phone book.

R-button and supplementary services

Your telephone supports the supplementary services offered by your telephone network provider, such as brokering, call waiting and conference facilities. These supplementary services can be used via the **R-button**. Please ask your telephone network provider which Flash time you need to set in order to use the supplementary services. Please contact the telephone network provider with regard to enabling the supplementary services. Setting the Flash time,  Page 152.

Answering machine in the telephone network

If your telephone network provider has an answering machine available for you in the telephone network, the (VMWI¹) indicates a new message has been recorded for you. The provision of an external answering machine and indication of new messages via an mailbox icon are optional services from the telephone network provider. These functions can only be used when your telephone network provider actually offers the service. Contact your network provider for further information.

Caller number display (CLIP²)



The caller number display function is an optional service offered by telephone network providers. Contact your network provider for further information.

If this function is available, the number of the caller appears in the display when the phone rings. If callers suppress transmission of their phone numbers, the numbers do not appear in the display and are not stored in the call log. A corresponding message indicating this appears in the display.

¹ VMWI: Visual Message Waiting Indication

² CLIP: Calling Line Identification Presentation

8 Menu Structure

Main menu

You can access the main menu by pressing the **Menü** softkey. The way to navigate through the menus is described in chapter 4.

SMS ¹

SMS schreiben	Text:	Nummer:	SMS senden
			SMS speichern
			SMS löschen
Eingang	Entry 1	Opt	SMS beantworten Text verwenden?
Entry 2			SMS löschen
Entry ...			Nummer anrufen
			Nummer speichern Name:
Ausgangsliste	Entry 1	Opt	SMS senden Nummer:
Entry 2			SMS ändern
Entry ...			SMS löschen
SMS-Einstellung.	SMS-Center	SMS-Center 1 - 4	Nummer:
Sendecent.wählen		Sende-Center 1 - 4	
SMS-Alarm		Aus	
		Ein	

¹ Further information on SMS text messages,  Page 157.

Menu Structure

Info	Use the Info button to open this menu directly.		
Eingang	Anrufbeantworter (-)	(only displayed with new messages)	
	Anrufliste (-)	(only displayed with new calls)	
	SMS (-)	(only displayed with new SMS)	
SMS	☞ Page 149		
Anrufliste	☞ Page 154		
Info Dienste	Entry 1	Opt	Eintrag ändern Nummer: Name:
	Entry ...		Eintrag löschen Löschen?

Display

Hintergrund	Hintergrund 1	(Wallpaper in Standby mode)
	Hintergrund 2	
	Hintergrund 3	
	Hintergrund 4	
	Hintergrund Aus	
Mobilteil-Name	Name:	
Display-Kontrast	Kontrast 1 - 8	
Farb-Schema	Blau / Rosa	
	Grün / Gelb	
	Violett / Braun	
Licht ein/aus	Aus	(Backlighting for the keypad)
	Ein	
Dimm-Modus	Aus	(Further information on "Dimm-Modus", ☞ Page 156)
	Immer ein	
	Für 10 Minuten	

Menu Structure

Töne

Tonruf	Ruf-Lautst.	Aus
Warntöne		Ruf-Lautst. 1 - 5
		Ruf-Lautst. ^ 1
	Ruf-Melodie	Ruf-Melodie 1 - 15
	Tastenton	Aus
		Ein
	Akku-Warnton	Aus
		Ein
	Reichweite!	Aus
		Ein

Einstellungen

MT-Einstellungen	Direktruf	PIN eingeben ² ◆
	◆ Direktruf ein	Nummer:
	Direktruf aus	
	Basis-Auswahl	Basis A
		Basis ...
	Direktnahme	Aus
		Ein
	Notruf-Nr. ◆	
	◆ Notruf-Nr. 1	Nummer:
	Notruf-Nr. ...	
	Rücksetzen	Rücksetzen?
	Sprache	Deutsch
		Français / Italiano

¹ This setting causes the volume to increase with each ring.

² The default PIN code is "0000".

Menu Structure

▼			
Basis-Einstellg.	Tonruf	Ruf-Lautst.	Aus
			Ruf-Lautst. 1 -5
		Ruf-Melodie	Ruf-Melodie 1 - 5
	Wahlverfahren	Tonwahl(DTMF)	
		Impulswahl	
	Amtskennziffer	Nummer:	
	PIN ändern ¹	Alte PIN:	Neue PIN: ▶
		▶	PIN wiederholen
	Rücksetzen	Rücksetzen?	PIN eingeben ▶
		▶	Bitte warten!
Datum / Zeit	Datum:	Zeit:	
Flash-Zeit	Flash 1 - 8		
MT anmelden	Basis A * ²	PIN eingeben	Suche Basis!
	BasisB		
	Basis C		
	Basis D		
MT abmelden	PIN eingeben	Mobilteil 1	MT abmelden?
		Mobilteil ...	

¹ The default PIN code is "0000".

² There are 4 memory locations available for registration of base stations. Memory locations identified by a star are already assigned. If a memory location is selected which is already assigned, the old registration in this memory location is overwritten.

Anrufbeantworter¹

Nachricht.hören		
Alle Nachr.lösch	Löschen?	
Anrufb.ein/aus	Aus	
	Ein	
AB-Einstellungen	Antwort-Modus	Mit Aufzeichng.
		Ohne Aufzeichn.
	Ansagetexte	Mit Aufzeichng. Ansage aufnehmen
		Ohne Aufzeichn.
	Ansagetext hören	Mit Aufzeichng.
		Ohne Aufzeichn.
	Aufnahmezeit	30 / 60 / 120 s
		Unbeschränkt
	Antw-Verzögerung	Spar-Modus
		2 Rufe
		4 Rufe
		6 Rufe
		8 Rufe
	Fernabf-PIN änd.	Alte PIN: Neue PIN: ▶
		▶ PIN wiederholen
Memo aufnehmen		

¹ Further information on the answering machine,  Page 140.

Menu Structure

Phone Book

Access the phone book by pressing .

Telefonbuch

Entry 1	Opt	Neuer Eintrag	Nummer:	Name: ¹
Entry 2		Eintrag ändern	Nummer:	Name: ¹
Entry ...		Eintrag löschen	Löschen?	
		Alle löschen	Löschen?	

Calls log

Press the  button to access the call log.

Anrufliste ²

Entry 1	Opt	Eintrag löschen	Löschen?
Entry 2		Liste löschen	Löschen?
Entry ...		Details	
		Nummer speichern	Name: ¹

¹ Letters are also imprinted on the digit keys. Letters, digits and special characters are entered by pressing the relevant key the respective number of times. Use the Star button to switch between entering upper and lower case and digits.

² The (CLIP³) feature is necessary to display and save phone numbers in various call logs. The caller number display function is an optional service offered by telephone network providers. Contact your network provider for further information. Further information on the CLIP function,  Page 148.

³ **CLIP:** Calling Line Identification Presentation

9 Special Functions

Auto talk function (taking calls directly)

If this function is activated, an incoming call is taken when the handset is removed from the base station. Setting the auto talk function,  Page 151.

Dialling mode

The telephone can be operated in new, digital exchanges (TONE) as well as analogue exchanges (PULSE). Setting the dialling mode,  Page 152.

Temporary tone dialling

If you only operate the telephone using the PULSE dialling mode, you can still make use of the advantages of the TONE dialling mode (e.g.: remote access of the answering machine in the conventional telephone network). You can temporarily switch to Tone dialling when a connection has already been made.

2 sec

Press the button when a connection has been established

When the call is ended, the equipment automatically switches back to Pulse dialling.

Baby call function

This function enables you to store a number which is automatically dialled after any button is pressed (except the softkey). Activating the baby call function,  Page 151.

, or

,

Deactivate the baby call function

Special Functions

Emergency call numbers

Up to 4 emergency numbers can be stored in your handset. These numbers can be dialled even if the key lock function is activated. Storing emergency call numbers,  Page 151.

Dimm-Modus

Setting	Effect
Aus	The backlighting for the display is switched off after 30 seconds.
Immer ein	The backlighting for the display is dimmed after 30 seconds but remains switched on.
Für 10 Minuten	The backlighting for the display is dimmed after 30 seconds and is switched off after a further 10 minutes.

10 SMS

Conditions for using SMS

The **CLIP**¹ feature must be available for your telephone connection. Contact your telephone network provider to ensure this feature is enabled on your telephone connection. To use the **SMS**² service, your telephone network provider must enable it.

- A text cannot be sent from every private branch exchange extension.



If you want to send SMS text messages from a private branch exchange extension, it is necessary to store the number for an outside line for your PBX in the handset preceding the Service Center number.

- Sending SMS messages is not available for Call-by-Call connections at present.
- Charges are made for sending SMS texts.
- If the recipient in the conventional telephone network does not use an SMS service or his telephone is not equipped to handle SMS messages, the SMS is automatically converted to a voice message.
- Costs are charged by your telephone network provider.

SMS Service Center

SMS messages are distributed via a Service Center. If you want to send SMS text messages, you must program a service center number in your handset  Page 149. Please contact the provider of your choice for the necessary service center call numbers and the procedure for enabling the SMS service.



Your telephone has already been prepared to send SMS text messages. Service Center numbers are already programmed in the handset. Activate the required Service Center in the SMS menu.  Page 150

Service Center 1	Service Center 2
Swisscom: 0622100000	Cablecom: 0435375370
Service Center 3	Service Center 4
Empty	Empty

¹ **CLIP**: Calling Line Identification Presentation

² **SMS**: Short Message Service

Entering text

The digit keys are also labelled with letters for the entry of the respective letters. Letters, digits and special characters are entered by pressing the relevant key the respective number of times.

0 , 1 or #	Enter special character
*	Switch between entering upper and lower case and digits
Lösch	Delete the last character entered
2 sec Lösch	Delete the entire text

SMS alert signal (alarm)

An acoustic signal is issued when a new SMS text message is received. You can activate or deactivate this signal. Activating/Deactivating the alarm signal, 
Page 150.

11 Expanding the Telephone System

The international **GAP**¹ standard regulates the compatibility of handsets and base stations from different manufacturers. As a result, it is possible to integrate SWITEL devices and devices from other manufacturers together in one telephone system. It is possible, however, that certain functions are not available.



Multiple handsets

Up to 5 handsets can be registered on the base station.

Registering handsets

Before starting with the registration process for a handset, switch the respective base station to Registration mode.

10 sec ,  Activate Registration mode

Complete the registration process for your handset,  Page 152. The currently valid PIN code is used for registration purposes,  Page 152.

The handset is automatically assigned an internal call number following registration. The internal call number appears in the display.



To register handsets from other manufacturers, please refer to the operating manual supplied with them.

Deregistering handsets





Each handset can deregister itself and other handsets registered on the base station. The message "Suche Basis!" appears in the display of the handset deregistered.

Deregistering handsets  Page 152.

Multiple base stations

Your handsets can be simultaneously registered on up to 4 different base stations. Each base station requires its own telephone cable socket. Connections can be used with the same call number or with different ones.

Switch the respective base stations to Registration mode. Register the handset  Page 152. Select the base station you wish to use for telephoning using the "Basis-Auswahl" menu,  Page 151.



¹ **GAP**: **Generic Access Profile** = Standard for the interoperation of handsets and base stations from other manufacturers.

In the Case of Problems



12 In the Case of Problems

Should problems arise with the telephone, please refer to the following information first. In the case of technical problems or in the case of claims under the terms of guarantee, contact your sales outlet. There is a 2 year period of guarantee.

Problems and solutions

Problems	Solutions
No connection to base station possible	<ul style="list-style-type: none">- Check that the handset has been registered on the base station with the correct PIN code.  Page 152
No telephone calls possible	<ul style="list-style-type: none">- The telephone is not connected properly or is defective. Only use the telephone connection cable supplied.- Test whether the telephone connection is in order by using another telephone.- The power adaptor plug is not plugged in or there is a complete power failure.- The rechargeable batteries are empty or defective.- The handset is too far from the base station.- Dialling mode is set incorrectly.  Page 152
Connection is disturbed or cut off	<ul style="list-style-type: none">- The handset is too far from the base station.- The base station is in an unsuitable location.
The system no longer responds	<ul style="list-style-type: none">- Reset all the functions to their default settings.  Page 162- Disconnect the power adapter plug briefly from the power socket.- Remove the batteries briefly from the handset.

In the Case of Problems

Problems	Solutions
The batteries are empty in a short time	<ul style="list-style-type: none">- Batteries are empty or defective.- Place the handset in the base station properly. Clean the contact surfaces on the handset and base station with a soft, dry cloth.- Place the handset in the base station for 16 hours.
The CLIP ¹ function does not work	<ul style="list-style-type: none">- The caller number display function is an optional service offered by telephone network providers. Contact your network provider for further information.- The caller has suppressed the transmission of their phone number.
The answering machine no longer records messages/memos	<ul style="list-style-type: none">- Ensure that the answering machine is connected correctly and switched on.- Check whether the answering machine memory is full. Delete messages from the memory, if necessary.  Page 143
No remote access functions can be executed	<ul style="list-style-type: none">- Check that the correct PIN code has been entered for the remote access.  Page 145- The telephone used for remote access must be set to tone dialling.

¹ **CLIP:** Calling Line Identification Presentation

Technical Properties

13 Technical Properties

Technical data

Feature	Value
Standard	DECT-GAP¹
Power supply (base station)	Input: 220/230 V, 50 Hz Output: 6 V, 600 mA
Range	Outdoors: Approx. 300 m Indoors: Approx. 50 m
Standby	Up to 100 h
Max. talk time	Up to 10 h
Rechargeable batteries	2 x 1.2 V, size: AAA
Dialling mode	Tone dialling mode Pulse dialling mode
Permissible ambient temperature	10°C to 30°C
Permissible relative humidity	20% to 75%
Flash function	80 ms, 100 ms, 120 ms, 180 ms, 250 ms, 300 ms, 600 ms, 800 ms

Default settings

Handset

Restoring the default settings,  Page 151

Language:	German	Emergency number 1:	Empty
Ringing melody:	6	Emergency number 2:	Empty
Dimm-Modus:	Für 10 Minuten		

¹ **DECT**: Digitally Enhanced Cordless Telecommunication = Standard for cordless telephones.

GAP: Generic Access Profile = Standard for the interoperation of handsets and base stations from other manufacturers.

Technical Properties

Ringing tone volume:	5	Emergency number 3:	Empty
Receiver volume:	3	Emergency number 4:	Empty
Handsfree mode volume:	3	Key tone:	On
Phone book:	Empty	HS name:	DFT727
Call log:	Empty	SMS:	Empty
Redialling list:	Empty	SMS alarm signal:	On
Baby call:	Off/Empty	Auto talk:	On
Number for outside line:	Empty	Display contrast:	4
Key lock:	Off	Menu colour:	Blue
Battery warning signal:	On	Keypad lighting:	On
Range warning signal:	On	Wallpaper:	Sky

Base station

Restoring the default settings,  Page 152

Ringing melody:	1	Flash time:	100 ms
Ringing tone volume:	5	Dialling mode:	Tone dialling
VIP phone book:	Empty	PIN:	0000

Answering machine

Ring delay:	4 rings	Answering mode	With recording
Answering machine:	On	Volume:	3

Declaration of Conformity

This device fulfils the requirements stipulated in the EU directive: 1999/5/EU directive on radio equipment and telecommunications terminal equipment and the mutual recognition of their conformity. Conformity with the above mentioned directive is confirmed by the CE symbol on the device.



To view the complete Declaration of Conformity, please refer to the rear side of this user guide.

14 Maintenance / Guarantee

Maintenance

- Clean the housing surfaces with a soft, fluff-free cloth.
- Never use cleaning agents or solvents.

Guarantee

SWITEL equipment is produced and tested according to the latest production methods. The implementation of carefully chosen materials and highly developed technologies ensure trouble-free functioning and a long service life. The terms of guarantee do not apply where the cause of equipment malfunction is the fault of the telephone network operator or any interposed private branch extension system. The terms of guarantee do not apply to the batteries or power packs used in the products. The period of guarantee is 24 months from the date of purchase.

All deficiencies resulting from material or production faults which occur during the period of guarantee will be eliminated free of charge. Rights to claims under the terms of guarantee are annulled following intervention by the purchaser or third parties. Damage caused as a result of improper handling or operation, incorrect positioning or storing, improper connection or installation, Acts of God or other external influence are not covered by the terms of guarantee. In the case of complaints, we reserve the right to repair or replace defect parts or provide a replacement device. Replacement parts or devices become our property. Rights to compensation in the case of damage are excluded where there is no evidence of intent or gross negligence by the manufacturer.

If your device shows signs of defect during the period of guarantee, please return it to the sales outlet in which you purchased the SWITEL device together with the purchase receipt. All rights to claims under the terms of guarantee in accordance with this agreement must be asserted exclusively with regard to your sales outlet. Two years after the purchase and transfer of our products, claims under the terms of guarantee can no longer be asserted.

15 Index

A

- Answer only, 142
- Answering machine, 140
- Answering machine in the telephone network, 148
- Auto talk function, 155
- Automatic dialling pause, 147

B

- Baby call function, 155
- Battery charge status, 130
- Brokering, 138

C

- Call number display, 148
- Call screening, 141
- Calls log, 136
- Chain dialling, 137
- Charging the batteries, 130
- Conference calls, 138
- Connecting the base station, 129
- Creating phone book entries, 135

D

- Declaration of Conformity, 163
- Default settings, 162
- Delay, 141
- Delete all messages/memos, 144
- Deleting memos, 143
- Deleting messages, 143
- Deleting outgoing messages, 142
- Deregistering handsets, 159
- Dialling mode, 152, 155
- Dialling phone numbers from the phone book, 136
- Dimm-Modus, 150, 156
- Direct call acceptance, 155
- Display, 132

E

- Emergency call numbers, 156
- Ending a call, 136
- Entering a dialling pause manually, 147
- Entering text, 158
- Expanding the telephone system, 159
- Explanations, 132

F

- Flash time, 152

G

- Guarantee, 164

H

- Handsfree, 139
- Holding a call, 138

I

- Icons in the display, 132
- In the case of problems, 160
- Inserting batteries, 130
- Internal calls, 137

K

- Key function assignment for remote access, 146
- Key lock, 139

M

- Main menu, 149
- Maintenance, 164
- Making a call, 136
- Making internal calls, 137
- Maximum recording time, 140
- Menu structure, 149
- Multiple base stations, 159
- Multiple handsets, 159
- Muting the microphone, 139

N

- Navigation buttons, 134
- Number for an outside line, 147

O

- Operating elements, 131
- Operating the telephone, 132

P

- Package contents, 129
- Paging, 139
- Phone book, 154
- PIN code for remote access, 145
- Playing memos, 143
- Playing messages, 143
- Private branch exchanges, 147
- Problems and solutions, 160
- Pulse dialling, 152
- Putting the telephone into operation, 129

R

- R button on private branch exchanges, 147
- R-button and supplementary services, 147
- Receiver volume, 138
- Recording a memo, 143
- Recording outgoing messages, 142
- Redialling, 136
- Registering handsets, 159
- Remote access, 145
- Remote control of the answering machine, 146
- Ringling melody, 139

S

- Safety information, 127
- Searching for the handset, 139
- Selecting the answering mode, 142
- Setting the answering machine volume, 141
- Setting the answering machine weekday and time, 140
- Setting the number of rings, 141
- SMS alarm, 158
- SMS alert, 158
- SMS conditions, 157
- SMS Service Centre, 157
- Special functions, 155
- Supplementary services, 147
- Switching the answering machine on/off, 140
- Switching the handset on and off, 139

T

- Taking a call, 136
- Taking a call being recorded, 141
- Talk time, 138
- Technical data, 162
- Telephoning, 136
- Temporary tone dialling, 155
- Time saver, 141
- Tone dialling (DTMF), 152
- Transferring external calls internally, 137
- Troubleshooting, 160

V

- VMWI, 148

SWITEL

Declaration of conformity

WE TELGO AG
OF Route d'Englisberg 17
CH-1763 Granges-Paccot

Declare under our own responsibility that the product

MODEL: DFT727

DESCRIPTION: Cordless DECT telephone with answering machine

Is in conformity with directives: R&TTE Directive (1999/5/EC)

COMPLIANCE IS ACHIEVED BY CONFORMITY TO THE FOLLOWING:

EN 60950-1, EN 301 489-1, EN 301 489-6, EN 55022, EN 301 406, EN 301 437 (TBR21), TBR 10 FP, TBR 10 PP

TEST REPORT NUMBERS:

3-4426-01-02/05, 3-4402-1-2/05, 3-4426-1-4/05, 3-4402-01-04/05, 3-4546-01-03/06,
3-4390_05-1-3 PP, 3-4426_01-03/05 PP, 3-4390_05-1-3 FP, 3-4402_05-1-3 FP, 220514-1,
220514-2, 220603-1

AUTHORISED BY:

Signed:



Name (printed):

Selim Dusi

Position in company:

Managing Director

Date of issue:

26.01.2006

Copies of this document will be held on file for a period of 10 years after the last production.



Supplier:

TELGO AG, Route d'Englisberg 17

CH-1763 Granges-Paccot

Product:

DFT727

This product is intended for connection to analogue PSTN lines within Switzerland. However, due to differences between the individual PSTNs provided in the different countries, the approval does not, of itself, give an unconditional assurance of successful operation on every PSTN network termination point.