

SWITEL

COMMUNICATION PRODUCTS

Schnurlostelefon
Téléphone sans fil
Telefono senza fili
Cordless telephone

DF 86x



Bedienungsanleitung
Mode d'emploi
Istruzioni per l'uso
Operating Instructions

D

F

I

GB

1	Sicherheitshinweise	2
2	Telefon in Betrieb nehmen	4
3	Bedienelemente	8
4	Einführende Informationen	10
5	Telefonieren	15
6	Weitere Leistungsmerkmale	19
7	Anrufliste / Wahlwiederholung	20
8	Telefonbuch	21
9	Telefon einstellen	23
10	Mobilteile an-/abmelden	29
11	Betrieb an Telefonanlagen/Zusatzdienste	30
12	Anhang	31

1 Sicherheitshinweise

Lesen Sie diese Bedienungsanleitung sorgfältig durch.

Bestimmungsgemäße Verwendung

Dieses Telefon ist geeignet zum Telefonieren innerhalb eines Telefonnetzes. Jede andere Verwendung gilt als nicht bestimmungsgemäß. Eigenmächtige Veränderungen oder Umbauten sind nicht zulässig. Öffnen Sie das Gerät in keinem Fall selbst und führen Sie keine eigenen Reparaturversuche durch.

Aufstellungsort

Vermeiden Sie Belastungen durch Rauch, Staub, Erschütterungen, Chemikalien, Feuchtigkeit, Hitze oder direkte Sonneneinstrahlung. Verwenden Sie das Mobilteil nicht in explosionsgefährdeten Bereichen.

Netzteil

 **Achtung:** Verwenden Sie nur das mitgelieferte Steckernetzteil, da andere Netzteile das Telefon beschädigen können. Sie dürfen den Zugang zum Steckernetzteil nicht durch Möbel oder andere Gegenstände versperren.

Akkus

 **Achtung:** Werfen Sie Akkus nicht ins Feuer. Verwenden Sie nur den mitgelieferten Akku! Achten Sie auf die richtige Polung! Bei verkehrter Polung des Akkus besteht beim Aufladen Explosionsgefahr.

Stromausfall

Bei Stromausfall kann mit dem Telefon nicht telefoniert werden. Halten Sie für Notfälle ein schnurgebundenes Telefon bereit, welches ohne externe Stromversorgung arbeitet.

Medizinische Geräte

 **Achtung:** Benutzen Sie das Telefon nicht in der Nähe von medizinischen Geräten. Eine Beeinflussung kann nicht völlig ausgeschlossen werden.

DECT¹-Telefone können in Hörgeräten einen unangenehmen Brummtönen verursachen.

Entsorgung

Wollen Sie Ihr Gerät entsorgen, bringen Sie es zur Sammelstelle Ihres kommunalen Entsorgungsträgers (z. B. Wertstoffhof). Das nebenstehende Symbol bedeutet, dass Sie das Gerät auf keinen Fall in den Hausmüll werfen dürfen! Nach dem Elektro- und Elektronikgerätegesetz sind Besitzer von Altgeräten gesetzlich gehalten, alte **Elektro- und Elektronikgeräte** einer getrennten Abfallerfassung zuzuführen.



Akkus entsorgen Sie beim batterievertreibenden Handel sowie bei zuständigen Sammelstellen, die entsprechende Behälter bereitstellen.



Verpackungsmaterialien entsorgen Sie entsprechend den lokalen Vorschriften.



¹ DECT: **D**igital **E**nhanced **C**ordless **T**elecommunication = Standard für kabellose Telefone.

2 Telefon in Betrieb nehmen

Sicherheitshinweise

 **Achtung:** Lesen Sie vor der Inbetriebnahme unbedingt die Sicherheitshinweise in Kapitel 1.

Verpackungsinhalt prüfen

Zum Lieferumfang gehören:

Inhalt	DF 86x-Modell			
	861	862 ¹	863 ¹	864 ¹
Basisstation mit Netzteil	1	1	1	1
Ladestation mit Netzteil	-	1	2	3
Mobilteil	1	2	3	4
Telefonanschlusskabel	1	1	1	1
Akkupack	1	2	3	4
Bedienungsanleitung	1	1	1	1

¹ Unter www.switel.com erfahren Sie, ob dieses Telefonset bereits erhältlich ist.

Stromverbrauch

Die **Leistungsaufnahme der Basisstation** beträgt:

- im Betrieb (Bereitschaft/Gespräch): ca. 1,2 W
- während der Ladung des Mobilteils: ca. 2 W.

Die Nulllast des Netzteils beträgt ca. 0,15 W.

Die durchschnittliche Effizienz beträgt ca. 60 %.

Die **Leistungsaufnahme der Ladestation** beträgt:

- ohne Mobilteil: ca. 0,15 W
- während der Ladung des Mobilteils: ca. 1,2 W.

Die Nulllast des Netzteils beträgt ca. 0,15 W.

Die durchschnittliche Effizienz beträgt ca. 60 %.

Basisstation anschließen

⚠ Achtung: Stellen Sie die Basisstation mit einem Mindestabstand von 1 m zu anderen elektronischen Geräten auf, da es sonst zu gegenseitigen Störungen kommen kann.

Schließen Sie die Basisstation wie auf der Skizze abgebildet an. Verwenden Sie aus Sicherheitsgründen nur das mitgelieferte Netzteil sowie das beige-fügte Telefonanschlusskabel.

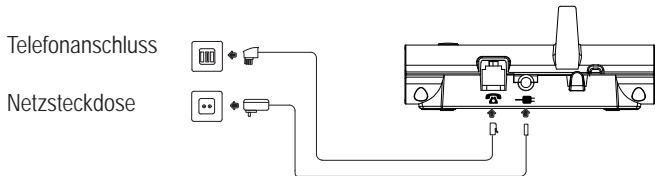

⚠ Achtung: Verwenden Sie für die Basisstation nur das mitgelieferte Netzteil S002CV0600030 / 6V, 300 mA DC!

Ladestation anschließen²

Schließen Sie die Ladestation wie auf der Skizze abgebildet an. Verwenden Sie aus Sicherheitsgründen nur das mitgelieferte Netzteil.

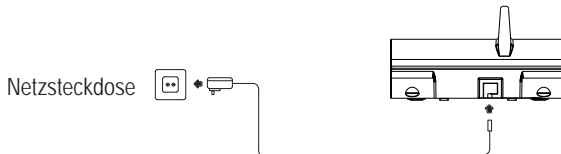

⚠ Achtung: Verwenden Sie für die Ladestation nur das mitgelieferte Netzteil S002CV0600030 / 6 V, 300 mA DC!

² Gilt nur für Telefonsets mit mindestens zwei Mobilteilen, siehe „Verpackungsinhalt prüfen“.

Telefon in Betrieb nehmen

Akku einlegen

Öffnen Sie das Akkufach.
Legen Sie den Akku wie dargestellt in das Akkufach ein und stellen Sie die Steckverbindung her.
Schließen Sie das Akkufach.

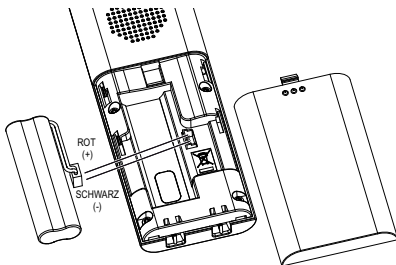

⚠ Achtung: Verwenden Sie nur den mitgelieferten Akkupack: 2,4 V, 500 mAh, NiMH! Achten Sie auf die richtige Polarität!

Akku aufladen

👉 Stellen Sie das Mobilteil bei der ersten Inbetriebnahme für mindestens 14 Stunden in die Basisstation / Ladestation.

Das Mobilteil erwärmt sich beim Laden. Dies ist normal und ungefährlich. Laden Sie das Mobilteil nicht mit fremden Aufladegeräten. Der Akkuladestatus wird im Display angezeigt. Wenn die Ladung des Akkus die untere Grenze erreicht hat, blinkt das Akkusymbol (🔋) im Display und Sie hören den Akku-Warnton (im Gespräch, falls Akku-Warnton eingeschaltet / Menüpunkt „MT einstellen / Hinweistöne / Akku leer“). Sie haben noch ca. 10 Minuten Gesprächszeit.

Datum und Uhrzeit des Mobilteils einstellen

Bei Inbetriebnahme verfügt das Mobilteil nicht über eine korrekte Uhrzeit (z. B. für Einträge in der Anrufliste). Datum und Uhrzeit stellen Sie über den Menüpunkt „Uhrzeit/Alarm / Datum/Zeit“ ein.

Displaysprache einstellen

Die Displaysprache ist in 4 verschiedenen Sprachen einstellbar. Im Auslieferungszustand ist „Deutsch“ eingestellt. Sie können die Sprache über den Menüpunkt „MT einstellen / Sprache“ ändern.

Automatische Rufannahme / Direktannahme

Ist die Funktion aktiviert (Auslieferungszustand), wird ein Anruf automatisch beim Herausnehmen des Mobilteils aus der Basisstation angenommen. Die automatische Anrufannahme wird über den Menüpunkt „MT einstellen / Direktannahme“ ein- oder ausgeschaltet.

3 Bedienelemente

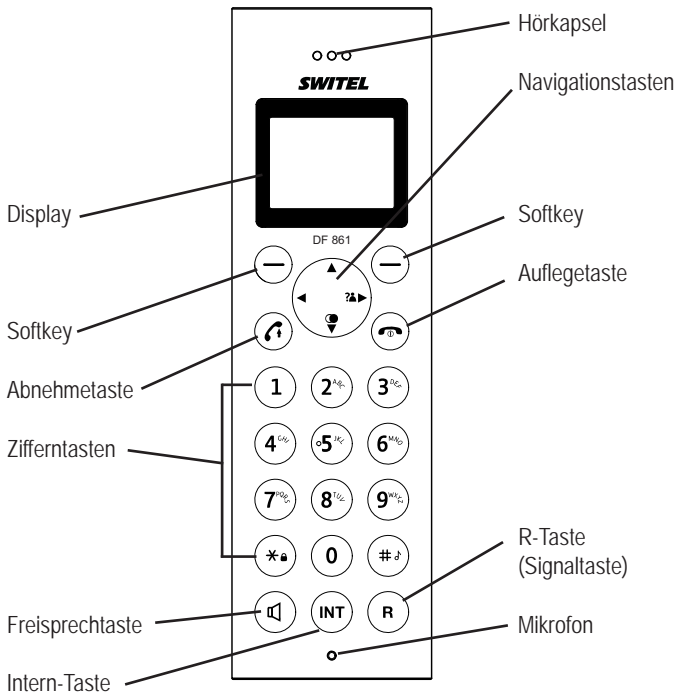

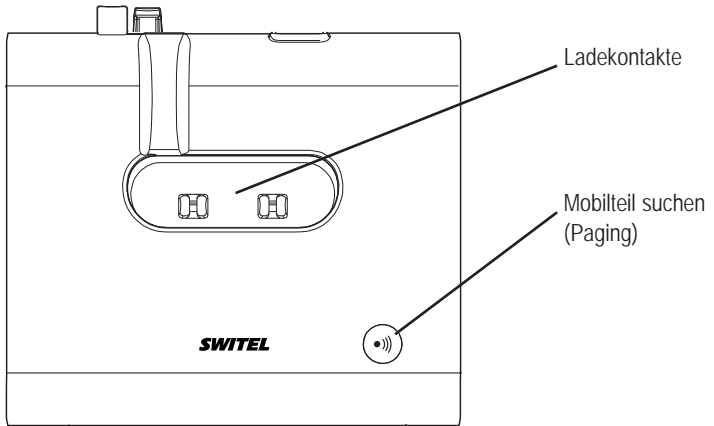







4 Einführende Informationen

In diesem Kapitel finden Sie grundlegende Informationen zur Handhabung der Bedienungsanleitung und des Telefons.

Darstellungweise in der Bedienungsanleitung

Darstellung	Beschreibung
	Abgebildete Taste drücken
	Ziffern oder Buchstaben eingeben
	Mobilteil klingelt
	Basisstation klingelt
	Mobilteil aus der Basisstation nehmen
	Mobilteil in die Basisstation stellen
Name?	Darstellung von Display-Texten
	Darstellung von Display-Symbolen

Symbole im Display des Mobilteils

Symbol	Beschreibung
	Konstant: Verbindung zur Basisstation. Blinkt: keine Verbindung zur Basisstation.
	Konstant: Anzeige der Akkukapazität. Durchlaufend während Mobilteil in der Basis: Der Akku wird geladen.
	Einige Segmente werden nicht angezeigt: Akku sollte geladen werden.
	Blinkend: Laden Sie den Akku. Konstant: Sie führen ein Gespräch.
	Blinkend: Sie erhalten gerade einen Anruf.
	Freisprechbetrieb ist aktiviert. Tonruf ist ausgeschaltet.



Konstant: Ein Alarm ist eingestellt.

Blinkt: Die eingestellte Alarmzeit ist erreicht.



Tastensperre ist eingeschaltet.



Sie führen ein Interngespräch (nur bei mehreren Mobilteilen an einer Basis);

Eintreffendes Interngespräch.



Während Anzeige der Anrufliste: Neuer Anruf



Weitere Ziffern/Buchstaben vor bzw. hinter den gegenwärtig angezeigten. Um diese anzuzeigen drücken Sie die jeweilige Navigationstaste links/rechts.

In der unteren Displayzeile werden zugehörig zu den beiden **Softkeys** die abhängig vom Betriebszustand verfügbaren Funktionen angezeigt.

Menü

Aufruf des Menüs.

TB

Aufruf des Telefonbuchs.

Wähle

Auswahl des markierten Menüpunkts / Eintrags.

OK

Bestätigung einer Einstellung.

Zurück

Zurück zum übergeordneten Menü bzw. Abbruch der Programmierung.

Lösche

Rückwärts-Löschen von Zeichen bei der Eingabe (kurzer Druck löscht letztes Zeichen, langer Druck die ganze Zeile).

Funktionen der Navigationstaste



Im Menü / in Listen (Telefonbuch, Anrufliste, Wahlwiederholung): Blättern aufwärts.



Während eines Gesprächs: Lautstärke erhöhen.

Während Bearbeitung von Einträgen / bei Wahlvorbereitung: Cursor nach links bewegen.



Im Bereitschaftszustand: Anrufliste öffnen

Während Bearbeitung von Einträgen / bei Wahlvorbereitung: Cursor nach rechts bewegen.



Im Bereitschaftszustand: Wahlwiederholungsliste öffnen.

Während eines Gesprächs: Lautstärke verringern.

Im Menü / in Listen (Telefonbuch, Anrufliste, Wahlwiederholung): Blättern abwärts.

Sonderfunktionen einiger Tasten



Bei der Rufnummerneingabe: langer Druck gibt eine Wahlpause ein.



Im Bereitschaftszustand: langer Tastendruck schaltet Tastensperre ein/aus.

Bei Namenseingaben: langer Tastendruck schaltet den Zeichensatz um (Lateinisch/Russisch/Griechisch), Tabellen siehe Anhang.

Während einer Verbindung: temporäre Umschaltung auf Tonwahl wenn Impulswahl eingeschaltet.



Im Bereitschaftszustand: langer Tastendruck schaltet Mobilteil-Tonruf ein/aus.

Bei Namenseingaben: langer Tastendruck schaltet zwischen Groß- und Kleinschreibung um.

Bereitschaftsmodus

Alle Beschreibungen in dieser Bedienungsanleitung gehen davon aus, dass sich das Mobilteil im Bereitschaftsmodus befindet. Den Bereitschaftsmodus erreichen Sie, indem Sie die Taste  drücken.

Strahlungsreduzierung (ECO-Mode)



Der ECO-Mode reduziert im Vergleich zu einem Standard-DECT-Schnurlos-telefon die Strahlung um bis zu 75 % im Gesprächsmodus (abhängig von der Entfernung des Mobilteils zur Basis).

Navigation im Menü

Alle Funktionen sind über unterschiedliche Menüs zu erreichen. Die komplette Menüstruktur finden Sie im Anhang.

Zur Navigation im Menü benutzen Sie die Softkeys und die Navigationstaste. Mit dem linken Softkey **Menü** öffnen Sie das Menü.

Mit den Navigationstasten  bzw.  bewegen Sie sich im Menü.

Zum Öffnen eines Untermenüs drücken Sie den Softkey **Wähle**.

Wollen Sie zum übergeordneten Menü zurück drücken Sie **Zurück**.

Durch Drücken der Auflegetaste gelangen Sie wieder in den Bereitschaftszustand.

5 Telefonieren

Anruf annehmen

  Ihr Telefon klingelt.

Befindet sich das Mobilteil **nicht** in der Basis:

 /  Drücken Sie die Abnehmetaste oder die Freisprechtaste.

Befindet sich das Mobilteil in der Basis und **Direktannahme** ist nicht eingeschaltet:

 /  Nehmen Sie das Mobilteil aus der Basis und drücken Sie die Abnehmetaste oder die Freisprechtaste.

Befindet sich das Mobilteil in der Basis und **Direktannahme** ist eingeschaltet:

 Nehmen Sie einfach das Mobilteil aus der Basis; das Gespräch wird automatisch angenommen.

Anrufen

 Geben Sie die Rufnummer ein.

Fehler bei der Eingabe mit **Lösche** korrigieren.

 /  Rufnummer wird gewählt.

 Sie können auch zuerst die Abnehmetaste drücken und erhalten damit das Freizeichen. Die eingegebenen Ziffern Ihrer gewünschten Rufnummer werden sofort gewählt. Eine Korrektur einzelner Ziffern der Rufnummer ist bei dieser Form des Gesprächsaufbaus nicht möglich.

Gespräch beenden

 /  Auflegetaste drücken oder Mobilteil in die Basis stellen.

Wahlwiederholung

 Ihr Telefon speichert die 20 zuletzt gewählten Rufnummern. Ist für die Rufnummer ein Telefonbucheintrag angelegt, wird der Name angezeigt. Um die zugehörige Rufnummer anzuzeigen drücken Sie **Wähle**.



Öffnen Sie die Wahlwiederholungsliste.



Wählen Sie einen Eintrag aus.



Rufnummer wird gewählt.

Aus der Anrufliste anrufen

 Ihr Telefon speichert die letzten 30 Anrufe in der Anrufliste. Ist für die Rufnummer ein Telefonbucheintrag angelegt, wird der Name angezeigt. Um die zugehörige Rufnummer anzuzeigen drücken Sie **Wähle**. Die Speicherung kann nur erfolgen, wenn die Funktion „Rufnummernübertragung (CLIP)“ an Ihrem Anschluss verfügbar ist und die Rufnummer vom Anrufer nicht unterdrückt oder aus anderen Gründen nicht übertragen wurde.



Öffnen Sie die Anrufliste.



Wählen Sie einen Eintrag aus.



Rufnummer wird gewählt.

Aus dem Telefonbuch anrufen

 Das Telefonbuch kann 100 Einträge aufnehmen. Zum Anlegen von Einträgen siehe Abschnitt „Telefonbuch“.

TB

Öffnen Sie das Telefonbuch.



Wählen Sie einen Eintrag aus.



Rufnummer wird gewählt.

Anzeige der Gesprächsdauer

Während eines Gesprächs wird die Gesprächsdauer in Stunden, Minuten und Sekunden angezeigt.

Hörer-/Lautsprecherlautstärke einstellen



Sie können während eines Gesprächs die Lautstärke in 5 Stufen einstellen (bei Hörerbetrieb -> Hörerlautstärke, bei Freisprechen -> Lautsprecherlautstärke).

Die Einstellungen sind getrennt voneinander und bleiben auch nach Ende des Gespräches gespeichert.

Mikrofon ausschalten (Mute)

Stumm

Sie können während eines Gesprächs das Mikrofon ausschalten, so dass Ihr Gesprächspartner Sie nicht hören kann. Im Display wird **Mikrofon aus** angezeigt.

Mik. an



Zum Einschalten des Mikrofons drücken Sie den Softkey erneut.

Intern telefonieren

 Interne Gespräche, Vermitteln und Konferenzgespräche sind nur möglich, wenn mehrere Mobilteile angemeldet sind. Ist dies nicht der Fall, wird im Display **Nicht verfügbar** angezeigt.

Internes Gespräch führen

INT

Drücken Sie die Taste **INT**. Sind zwei Mobilteile angemeldet, wird das andere Mobilteil sofort gerufen. Bei mehreren angemeldeten Mobilteilen werden deren interne Nummern angezeigt (z. B. 2 3 4). Wählen Sie mit der Navigationstaste  /  das gewünschte Mobilteil aus und drücken Sie **Wähle**. Wählen Sie „9“ werden alle angemeldeten gleichzeitig gerufen.

Externes Gespräch vermitteln

INT

Während eines Externgesprächs . . .

Drücken Sie die Taste **INT**.

Wählen Sie mit der Navigationstaste  das gewünschte Mobilteil aus und drücken Sie **Wähle**.

Das externe Gespräch wird gehalten.

Wenn das gerufene Mobilteil eingeschaltet wird ggf. Gespräch ankündigen.



Drücken Sie die Auflegetaste. Das Gespräch ist übergeben.

Makeln

INT

Während eines Externgesprächs . . .

Drücken Sie die Taste **INT**.

Wählen Sie mit der Navigationstaste  das gewünschte Mobilteil aus und drücken Sie **Wähle**.

Das externe Gespräch wird gehalten.

INT

Mit der Taste **INT** schalten Sie zwischen den Gesprächspartnern hin und her.

Konferenz

INT

Während des Makelns (s. o.) . . .

Sie sprechen mit dem anderen internen Teilnehmer:

Drücken und halten Sie die Taste **INT** bis **Konferenz** im Display erscheint.



Legt einer der beteiligten Konferenzteilnehmer auf, bleiben die beiden anderen miteinander verbunden.

6 Weitere Leistungsmerkmale

Tastensperre

 Die Tastensperre verhindert ein unbeabsichtigtes Betätigen der Tasten. Eintreffende Anrufe können wie gewohnt entgegengenommen werden.



Drücken und halten Sie die Stern-Taste bis im Display das Symbol für die Tastensperre erscheint.



Zum Entsperren der Tastatur drücken und halten Sie die Stern-Taste erneut bis das Symbol wieder erlischt.

Tonruf ausschalten

 Sie können den Tonruf auch über das Menü „MT einstellen / Tonruf einstell. / Tonruflautstärke“ ausschalten.



Drücken und halten Sie die Raute-Taste bis im Display das Symbol für den ausgeschalteten Tonruf  erscheint.



Zum Wiedereinschalten des Tonrufs drücken und halten Sie die Raute-Taste erneut bis das Symbol wieder erlischt.

Mobilteil ausschalten

 Sie können das Mobilteil ausschalten um den Akku zu schonen.



Drücken Sie die Auflegetaste und halten Sie sie gedrückt. Nach wenigen Sekunden wird das Mobilteil ausgeschaltet. Die Displaybeleuchtung erlischt.



Zum Wiedereinschalten des Mobilteils drücken Sie die Auflegetaste so lange, bis Sie einen Signalton hören und das Display wieder leuchtet.

7 Anrufliste / Wahlwiederholung

Anrufliste bearbeiten



Öffnen Sie die Anrufliste.



Wählen Sie einen Eintrag aus und drücken Sie **Wähle**.
Datum und Uhrzeit des Anrufs werden angezeigt.

Menü

Drücken Sie den Softkey **Menü**.



Wählen Sie aus den folgenden Möglichkeiten und bestätigen Sie mit **Wähle**:

In TB speichern Die Rufnummer wird im Telefonbuch gespeichert. Geben Sie einen Namen ein, bestätigen oder bearbeiten Sie die Rufnummer und legen Sie eine Tonrufmelodie für diesen Eintrag fest.

Löschen Der Eintrag wird nach einer Sicherheitsabfrage gelöscht.

Alle löschen Die Liste wird nach einer Sicherheitsabfrage gelöscht.

 Sie können die Anrufliste auch über das Menü öffnen:

(Menü  /  **Anrufliste / Anrufe Empfangen / Wähle**).

Wahlwiederholung bearbeiten



Öffnen Sie die Wahlwiederholung.



Wählen Sie einen Eintrag aus und drücken Sie **Wähle**

Menü

Drücken Sie den Softkey **Menü**.



Wählen Sie aus den folgenden Möglichkeiten und bestätigen Sie mit **Wähle**:

In TB speichern Die Rufnummer wird im Telefonbuch gespeichert. Geben Sie einen Namen ein, bestätigen oder bearbeiten Sie die Rufnummer und legen Sie eine Tonrufmelodie für diesen Eintrag fest.

Löschen Der Eintrag wird nach einer Sicherheitsabfrage gelöscht.

Alle löschen Die Liste wird nach einer Sicherheitsabfrage gelöscht.

8 Telefonbuch

 Im Telefonbuch können Sie 100 Rufnummern und zugehörige Namen speichern. Sie können jedem Eintrag eine eigene Melodie zuordnen, mit der ein Anruf signalisiert werden soll. Geben Sie die Rufnummern immer mit der Ortsvorwahl ein; das ermöglicht eine korrekte Anzeige des jeweiligen Anrufers, für den ein Eintrag angelegt ist und dessen Übertragung der Rufnummer an Ihrem Anschluss verfügbar ist.

Neuen Eintrag anlegen

Menü

Drücken Sie den Softkey **Menü**.



Wählen Sie **Telefonbuch** und drücken Sie **Wähle**.



Ggf. **Hinzufügen** auswählen und **Wähle** drücken.



Geben Sie den Namen ein (maximal 12 Zeichen).

Die Zifferntasten sind mit Buchstaben beschriftet. Durch mehrmaliges Drücken der entsprechenden Taste können Buchstaben und Ziffern eingegeben werden.

Zwischen Groß- und Kleinbuchstaben können Sie mit der Raute-Taste (langer Tastendruck) umschalten.

Nach kurzer Zeit springt die Einfügemarke (Cursor) weiter.

Nach Eingabe des Namens drücken Sie **OK**.



Geben Sie die Rufnummer ein (maximal 24 Ziffern). Ist Ihr Telefon an einer Telefonanlage angeschlossen, geben Sie die Amtskennziffer mit ein. Ist eine Wahlpause erforderlich, drücken Sie nach der Amtskennziffer die Taste **0** für ca. 2 s; im Display wird **P** angezeigt.

Nach Eingabe der Rufnummer drücken Sie **OK**.

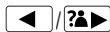

Wählen Sie eine Melodie für den Eintrag aus.

OK

Bestätigen Sie mit **OK**.

Telefonbucheinträge bearbeiten

- Menü** Drücken Sie den Softkey **Menü**.
-  /  Wählen Sie **Telefonbuch** und drücken Sie **Wähle**.
-  /  Wählen Sie aus den folgenden Möglichkeiten und bestätigen Sie mit **Wähle**:
- Lesen** Alle Einträge werden angezeigt. Blättern Sie zum gewünschten Eintrag. Mit **Wähle** sehen Sie Name, Rufnummer und Melodie. Mit **Menü** können Sie den Eintrag ändern oder löschen.
- Hinzufügen** Sie können einen neuen Eintrag anlegen.
- Bearbeiten** Alle Einträge werden angezeigt. Blättern Sie zum gewünschten Eintrag. Nach **Wähle** können Sie den Eintrag ändern. Löschen Sie Buchstaben und Ziffern mit **Lösche**, geben Sie mit den Zifferntasten neue Buchstaben und Ziffern ein. Einzelheiten dazu siehe unter „Neuen Eintrag anlegen“.
- Löschen** Alle Einträge werden angezeigt. Blättern Sie zum gewünschten Eintrag. Nach **Wähle** wird der Eintrag sofort gelöscht.
- Alle löschen** Nach **Wähle** wird das komplette Telefonbuch nach einer Sicherheitsabfrage gelöscht.
- Tel.buch-Status** Die aktuelle Belegung wird angezeigt (z. B. **7/100 Bel.:** 7 von 100 möglichen Einträgen sind vorhanden).

9 Telefon einstellen

Datum/Zeit

Menü



Drücken Sie den Softkey **Menü**.

Wählen Sie **Uhrzeit/Alarm** und drücken Sie **Wähle**.

Wählen Sie **Datum/Zeit** und drücken Sie **Wähle**.

Wählen Sie aus den folgenden Möglichkeiten und bestätigen Sie mit **Wähle**:

Datumsformat

Sie können die Darstellung des Datums einstellen: (TT-MM-JJJJ oder MM-TT-JJJJ).

Zeitformat

Sie können die Darstellung der Zeit einstellen: (24 oder 12 Stunden).

Datum eingeben Geben Sie mit den Zifferntasten das Datum ein.

Zeit eingeben Geben Sie mit den Zifferntasten die Uhrzeit ein. Bei Eingabe im 12-h-Format schalten Sie mit der Stern-Taste zwischen „AM“ und „PM“ um.

 Bei einem Stromausfall geht die Einstellung verloren, wenn gleichzeitig das Mobilteil ausgeschaltet ist oder der Akku leer ist.

Wecker

Menü

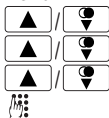

Drücken Sie den Softkey **Menü**.

Wählen Sie **Uhrzeit/Alarm** und drücken Sie **Wähle**.

Wählen Sie **Alarm** und drücken Sie **Wähle**.

Wählen Sie **Alarm ein** und drücken Sie **Wähle**.

Geben Sie mit den Zifferntasten die Weckzeit ein und drücken Sie **OK**.



Wählen Sie **Snooze ein** oder **Snooze aus** und drücken Sie **Wähle**. Ist „Snooze“ eingeschaltet, bedeutet dies, dass das Wecksignal nach 2 Minuten wiederholt wird, bis diese Funktion durch Drücken und Halten der Auflegetaste beendet wird.

Telefon einstellen

Ist „Snooze“ ausgeschaltet, wird das Wecksignal einmalig zur eingestellten Zeit gegeben. Zum Quittieren des Wecksignals drücken Sie eine beliebige Taste.



Wählen Sie **Alarm Melodie** und drücken Sie **Wähle**.

Wählen Sie eine der angebotenen Melodien aus und drücken Sie **Wähle**.

Audioeinstellungen für das Mobilteil

Menü



Drücken Sie den Softkey **Menü**.

Wählen Sie **MT einstellen** und drücken Sie **Wähle**.

Wählen Sie **Audioeinstellung** und drücken Sie **Wähle**.

Wählen Sie aus den folgenden Möglichkeiten und bestätigen Sie mit **Wähle**:

FS-Lautstärke

Wählen Sie die Lautstärke für die Wiedergabe im Freisprechbetrieb aus.

Hörerlautstärke

Wählen Sie die Lautstärke für die Hörerlautstärke aus.

 Diese Einstellungen können Sie auch während eines Gesprächs einfach mit den Navigationstasten vornehmen (s. „Telefonieren / Hörer-/Lautsprecherlautstärke einstellen“)

Tonruf für das Mobilteil einstellen

Menü



Drücken Sie den Softkey **Menü**.

Wählen Sie **MT einstellen** und drücken Sie **Wähle**.

Wählen Sie **Tonruf einstell.** und drücken Sie **Wähle**.

Wählen Sie aus den folgenden Möglichkeiten und bestätigen Sie mit **Wähle**:

Melodie intern

Wählen Sie eine Melodie für die Signalisierung eines internen Anrufes aus.

Melodie extern

Wählen Sie eine Melodie für die Signalisierung eines externen Anrufes aus.

Tonruflautstärke Wählen Sie die Lautstärke für den Tonruf aus. Wählen Sie „Tonruf aus“ wird das Symbol im Display angezeigt.

Hinweistöne einstellen

Menü



Drücken Sie den Softkey **Menü**.



Wählen Sie **MT einstellen** und drücken Sie **Wähle**.



Wählen Sie **Hinweistöne** und drücken Sie **Wähle**.

Wählen Sie aus den folgenden Möglichkeiten und bestätigen Sie mit **Wähle**:

Tastenton

Schalten Sie den Quittungston für eine Tastenbetätigung ein oder aus.

Akku leer

Schalten Sie den Hinweiston ein oder aus. Der Ton signalisiert, wenn der Akku geladen werden muss.

Reichweite

Schalten Sie den Hinweiston ein oder aus. Der Ton signalisiert, wenn Sie sich mit dem Mobilteil am Rande der Reichweite zur Basis befinden.

Displaysprache einstellen

Menü



Drücken Sie den Softkey **Menü**.



Wählen Sie **MT einstellen** und drücken Sie **Wähle**.



Wählen Sie **Sprache** und drücken Sie **Wähle**.

Wählen Sie eine Sprache und bestätigen Sie mit **Wähle**.

Mobilteilnamen einstellen

Menü



Drücken Sie den Softkey **Menü**.



Wählen Sie **MT einstellen** und drücken Sie **Wähle**.



Wählen Sie **MT-Namen ändern** und drücken Sie **Wähle**.

Löschen Sie den alten Namen mit **Lösche**, geben Sie mit den Zifferntasten einen neuen Namen ein und drücken Sie **OK**.

Telefon einstellen

Kontrast einstellen

Menü



Drücken Sie den Softkey **Menü**.

Wählen Sie **MT einstellen** und drücken Sie **Wähle**.

Wählen Sie **Kontrast** und drücken Sie **Wähle**.

Wählen Sie den gewünschten Kontrast aus und drücken Sie **Wähle**.

Automatische Rufannahme (Direktannahme) einstellen

Menü



Drücken Sie den Softkey **Menü**.

Wählen Sie **MT einstellen** und drücken Sie **Wähle**.

Wählen Sie **Direktannahme** und drücken Sie **Wähle**.

Wählen Sie, ob im die automatische Rufannahme ein- oder ausgeschaltet sein soll und bestätigen Sie mit **Wähle**.

 Bei eingeschalteter Direktannahme wird ein Anruf sofort angenommen wenn das Mobilteil aus der Basis genommen wird.

Basisstation auswählen

Menü



Drücken Sie den Softkey **Menü**.

Wählen Sie **MT einstellen** und drücken Sie **Wähle**.

Wählen Sie **Basisauswahl** und drücken Sie **Wähle**.

Sie sehen eine Liste der Basisstationen, an denen das Mobilteil angemeldet wurde. Die zzt. aktive Basis ist mit einem „*“ gekennzeichnet. Wählen Sie eine Basis und drücken Sie **Wähle**.

 Es werden nur die Basisstationen angezeigt, an denen das Mobilteil bereits eingebucht worden ist.

Mobilteil in den Auslieferungszustand zurücksetzen

Menü



Drücken Sie den Softkey **Menü**.

Wählen Sie **MT einstellen** und drücken Sie **Wähle**.

Wählen Sie **MT rücksetzen** und drücken Sie **Wähle**.

Geben Sie die aktuelle PIN ein und drücken Sie **OK**.

Bestätigen Sie auch die nachfolgende Sicherheitsabfrage mit **OK**.

Die Einträge im Telefonbuch werden nicht gelöscht.

Tonruf für die Basisstation einstellen

Menü



Drücken Sie den Softkey **Menü**.

Wählen Sie **Basis einstellen** und drücken Sie **Wähle**.

Wählen Sie **Tonruf einstell.** und drücken Sie **Wähle**.

Wählen Sie aus den folgenden Möglichkeiten und bestätigen Sie mit **Wähle**:

Tonrufmelodie Wählen Sie eine Melodie für die Signalisierung eines Anrufes aus.

Tonruflautstärke Wählen Sie die Lautstärke oder schalten Sie den Tonruf aus.

Wahlverfahren einstellen

Menü



Drücken Sie den Softkey **Menü**.

Wählen Sie **Basis einstellen** und drücken Sie **Wähle**.

Wählen Sie **Wahlverfahren** und drücken Sie **Wähle**.

Wählen Sie **Tonwahl** oder **Pulswahl** und bestätigen Sie mit **Wähle**.

Für die meisten Anschlüsse ist **Tonwahl (DTMF)** die richtige Einstellung.

Telefon einstellen

Flashzeit einstellen

Menü



Drücken Sie den Softkey **Menü**.



Wählen Sie **Basis einstellen** und drücken Sie **Wähle**.



Wählen Sie **Flash-Zeit** und drücken Sie **Wähle**.

Wählen Sie **Kurz** (100 ms), **Mittel** (300 ms) oder **Lang** (600 ms) und bestätigen Sie mit **Wähle**.

PIN ändern

Menü



Drücken Sie den Softkey **Menü**.



Wählen Sie **Basis einstellen** und drücken Sie **Wähle**.



Wählen Sie **PIN ändern** und drücken Sie **Wähle**.



Geben Sie die aktuelle PIN ein

(im Auslieferungszustand 0 0 0 0) und drücken Sie **OK**.



Geben Sie eine neue PIN ein und drücken Sie **OK**.



Geben Sie die neue PIN noch einmal ein und drücken Sie **OK**.

Die vierstellige PIN schützt einige Einstellungen vor unbefugtem Zugriff. Wenn Sie die PIN vergessen haben wenden Sie sich bitte an unsere Service-Hotline.

Basisstation in den Auslieferungszustand zurücksetzen

Menü



Drücken Sie den Softkey **Menü**.



Wählen Sie **Basis einstellen** und drücken Sie **Wähle**.



Wählen Sie **Basis rücksetzen** und drücken Sie **Wähle**.

Geben Sie die aktuelle PIN ein und drücken Sie **OK**. Bestätigen Sie auch die nachfolgende Sicherheitsabfrage mit **OK**.

Die Einträge im Telefonbuch werden nicht gelöscht. Angemeldete Mobilteile bleiben angemeldet.

10 Mobilteile an-/abmelden

An einer Basisstation können bis zu 5 Mobilteile angemeldet werden. Die mit Ihrem Telefon ausgelieferten Mobilteile sind bereits an der Basis angemeldet. Um ein „fremdes“ Mobilteil anzumelden beachten Sie bitte auch dessen Bedienungsanleitung.

Weiteres Mobilteil des gleichen Typs anmelden

Menü



Drücken Sie den Softkey **Menü**.

Wählen Sie **MT anmelden** und drücken Sie **Wähle**.

Wählen Sie eine Basisstation aus und drücken Sie **Wähle**. Basisstationen, an denen das Mobilteil bereits angemeldet ist, sind in Konturschrift dargestellt. Die aktuelle Basis ist durch einen * gekennzeichnet.



Geben Sie die aktuelle PIN der Basis ein, an der das Mobilteil angemeldet werden soll, und drücken Sie **OK**.



Drücken und halten Sie die Paging-Taste an der Basisstation so lange, bis der Anmelde-ton hörbar ist (ca. 5 s).

Nach einer kurzen Zeit leuchtet das Antennensymbol im Display konstant und das Mobilteil ist angemeldet.

Mobilteil löschen

Menü



Drücken Sie den Softkey **Menü**.

Wählen Sie **Basis einstellen** und drücken Sie **Wähle**.

Wählen Sie **MT löschen** und drücken Sie **Wähle**.

Geben Sie die aktuelle PIN ein und drücken Sie **OK**.

Wählen Sie eines der angezeigten Mobilteile aus und drücken Sie **Wähle**.

Das Mobilteil, das Sie gerade benutzen, kann nicht abgemeldet werden.

11 Betrieb an Telefonanlagen/Zusatzdienste

Betrieb an Telefonanlagen

Ist Ihr Telefon an einer Telefonanlage angeschlossen, können Sie über die R-Taste Funktionen, wie z. B. Anrufe weiterleiten und automatischen Rückruf nutzen. Lesen Sie bitte in der Bedienungsanleitung Ihrer Telefonanlage, welche Flash-Zeit Sie zur Nutzung dieser Funktionen einstellen müssen. Ob Ihr Telefon an Ihrer Telefonanlage einwandfrei funktioniert, erfahren Sie bei dem Händler, bei dem die Anlage gekauft wurde.

Bitte denken Sie daran, bei Telefonbucheinträgen ggf. die Amtskennziffer und eine ggf. erforderliche Wahlpause (Ziffer „0“ lange drücken) mit einzugeben.

Zusatzdienste Ihres Netzbetreibers

Ihr Telefon unterstützt Zusatzdienste Ihres Netzbetreibers, wie z. B. Makeln, Anklopfen und Konferenz. Über die R-Taste können Sie diese Zusatzdienste nutzen. Bitte erkundigen Sie sich bei Ihrem Netzbetreiber, welche Flash-Zeit Sie zur Nutzung von Zusatzdiensten einstellen müssen. Zur Freischaltung von Zusatzdiensten wenden Sie sich bitte an Ihren Netzbetreiber.

12 Anhang

Menüstruktur

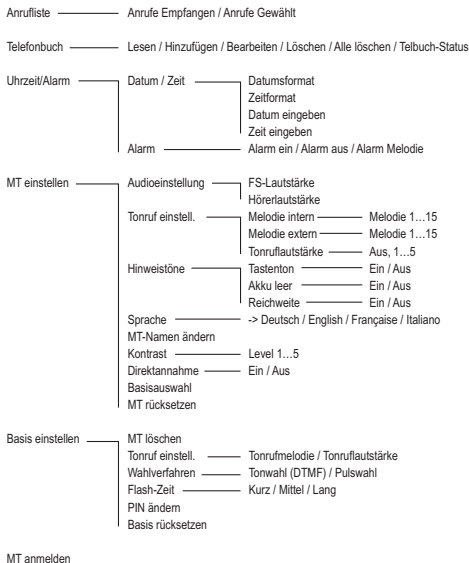

Zeichentabellen

Zeichensatz Lateinisch / Großbuchstaben

0	SP	0	-	+	=	_	()	"	'	[]	{	}	<	>	/	\	^	~	
1	1	.	,	:	;	!	ı	?	ı	*	#	&	%	\$	€	£	@	¤	§		
2	A	B	C	2	À	Á	Â	Ã	Ä	Å	Ą	Æ	Ç	Ć	Č						
3	D	E	F	3	Ď	È	É	Ê	Ë	Ě	Ĕ	Ė									
4	G	H	I	4	Ğ	Ì	Í	Î	Ï	Ī	ı	Ĳ									
5	J	K	L	5	Ł	Ł	Ł														
6	M	N	O	6	Ñ	Ń	Ń	Ò	Ó	Ô	Õ	Ö	Ø	Ǿ							
7	P	Q	R	7	Ŕ	Ř	Ś	Ş	Š	ß											
8	T	U	V	8	Ť	Ù	Ú	Û	Ü	Ū	Ŭ	Ů									
9	W	X	Y	Z	9	Ŵ	Ŷ	Ý	Ÿ	Ž	Ž	Ž									

Zeichensatz Lateinisch / Kleinbuchstaben

0	SP	0	-	+	=	_	()	"	'	[]	{	}	<	>	/	\	^	~	
1	1	.	,	:	;	!	ı	?	ı	*	#	&	%	\$	€	£	@	¤	§		
2	a	b	c	2	à	á	â	ã	ä	å	ą	æ	ç	ć	č						
3	d	e	f	3	ď	è	é	ê	ë	ě	ĕ	ė									
4	g	h	i	4	ğ	ì	í	î	ï	ĭ	ı	ĳ									
5	j	k	l	5	ł	ł	ł														
6	m	n	o	6	ñ	ń	ń	ò	ó	ô	õ	ö	ø	Ǿ							
7	p	q	r	7	ř	ř	ś	ş	š	ß											
8	t	u	v	8	ť	ù	ú	û	ü	ū	ŭ	ů									
9	w	x	y	z	9	ŵ	ŷ	ý	ÿ	ž	ž	ž									

Zeichensatz Russisch / Großbuchstaben

0	SP	0	-	+	=	_	()	"	'	[]	{	}	<	>	/	\	^	~	
1	1	.	,	:	;	!	і	?	ı	*	#	&	%	\$	€	£	@	¤	§		
2	А	Б	В	Г	2																
3	Д	Е	Ж	З	3																
4	И	Й	К	Л	4																
5	М	Н	О	П	5																
6	Р	С	Т	У	6																
7	Ф	Х	Ц	Ч	7																
8	Ш	Щ	Ъ	Ы	8																
9	Ь	Э	Ю	Я	9																

Zeichensatz Russisch / Kleinbuchstaben

0	SP	0	-	+	=	_	()	"	'	[]	{	}	<	>	/	\	^	~	
1	1	.	,	:	;	!	і	?	ı	*	#	&	%	\$	€	£	@	¤	§		
2	а	б	в	г	2																
3	д	е	ж	з	3																
4	и	й	к	л	4																
5	м	н	о	п	5																
6	р	с	т	у	6																
7	ф	х	ц	ч	7																
8	ш	щ	ъ	ы	8																
9	ь	э	ю	я	9																

Zeichensatz Griechisch / Großbuchstaben

0	SP	0	-	+	=	_	()	"	'	[]	{	}	<	>	/	\	^	~		
1	1	.	:	:	!	!	?	¿	*	#	&	%	\$	@	£	€	¤	§				
2	A	B	Γ	2																		
3	Δ	E	Z	3																		
4	H	Θ	I	4																		
5	K	Λ	M	5																		
6	N	Ξ	Ο	6																		
7	Π	P	Σ	7																		
8	T	Υ	Φ	8																		
9	X	Ψ	Ω	9																		

Zeichensatz Griechisch / Kleinbuchstaben

0	SP	0	-	+	=	_	()	"	'	[]	{	}	<	>	/	\	^	~		
1	1	.	:	:	!	!	?	¿	*	#	&	%	\$	@	£	€	¤	§				
2	α	β	γ	2																		
3	δ	ε	ζ	3																		
4	η	θ	ι	4																		
5	κ	λ	μ	5																		
6	ν	ξ	ο	6																		
7	π	ρ	ς	σ	7																	
8	τ	υ	φ	8																		
9	χ	ψ	ω	9																		

Fehlersuche

Haben Sie Probleme mit Ihrem Telefon, kontrollieren Sie zuerst die folgenden Hinweise. Bei technischen Problemen können Sie sich an unsere Service-Hotline unter Tel. 0900 00 1675 innerhalb der Schweiz (Kosten aus dem Festnetz von Swisscom bei Drucklegung: CHF 2.60/min) wenden. Bei Garantieansprüchen wenden Sie sich an Ihren Fachhändler. Die Garantiezeit beträgt 2 Jahre.

- Nach Betätigung der Abhebetaste ist kein Wählton hörbar, die Wählleitung wird nicht belegt.
 - Telefonanschluss-Stecker an der Basisstation und an der Telefonsteckdose kontrollieren.
 - Netzstecker an der Basisstation und an 230 V kontrollieren.
 - Die Wählleitung wird durch ein anderes Mobilteil belegt. Warten Sie, bis die Verbindung beendet ist.
- Displayanzeige: „Suche“.
 - Netzstecker an der Basisstation und an 230 V kontrollieren.
 - Reichweite verringern.
 - Mobilteil anmelden.
- Basisstation klingelt nicht.
 - Tonruf ausgeschaltet -> einschalten.
- Keine Anzeige auf dem Display.
 - Mobilteil ausgeschaltet -> einschalten.
 - Akku leer -> aufladen.

Werkseinstellungen/Auslieferungszustand

Anrufliste	Kein Eintrag
Telefonbuch	Kein Eintrag
Wecker	Aus
Tonruf Mobilteil	Intern: Melodie 2 Extern: Melodie 1 Tonruflautstärke: 3
Tonruf Basis	Melodie 1 Tonruflautstärke: 3
Hinweistöne	Tastenton: Ein Akku leer: Ein Reichweite: Ein
Sprache	Deutsch
Mobilteilname	DF86x
Autom. Rufannahme	Ein
Datum & Zeit	Datumsformat: TT-MM-JJJJ Zeitformat: 24 Stunden
Wahlverfahren	Tonwahl
Flash-Zeit	Kurz (100 ms)
PIN	0 0 0 0

Technische Daten

Standard: DECT / GAP

Kanalzahl: 120 Duplexkanäle

Frequenzen: 1880 MHz bis 1900 MHz

Duplexverfahren: Zeitmultiplex, 10ms Rahmenlänge

Kanalraster: 1728 kHz

Bitrate: 1152 kBit / s

Modulation: GFSK

Sprachkodierung: 32 kBit / s

Sendeleistung: 10 mW (mittlere Leistung pro Kanal)

Reichweite: bis zu 300 Meter im Freien, in Gebäuden bis zu 50 Metern

Stromversorgung Basisstation:

100~240 V AC (Steckernetzgerät S002CV0600030), 6 V DC / 300 mA

Stromversorgung Ladestation:

100~240 V AC (Steckernetzgerät S002CV0600030), 6 V DC / 300 mA

Betriebsdauer Mobilteil: in Bereitschaft / im Gespräch

500 mAh = ca. 100 h / ca. 10 h

Ladezeit der Akkus: ca. 14 Stunden

Zulässige Umgebungsbedingungen für den Betrieb des Mobilteils:

5°C bis 40°C ; 20 % bis 75 % relative Luftfeuchtigkeit

Zulässige Umgebungsbedingungen für den Betrieb der Basisstation:

5°C bis 40°C ; 20 % bis 75 % relative Luftfeuchtigkeit

Zulässige Lagertemperatur: -10°C bis +60°C

Wahlverfahren: MFV / IWW

R-Taste: Flash (100 ms/300 ms/600 ms)

Abmessungen Basisstation (mm): L / B / H = ca. 110 x 92 x 29/45

Abmessungen Mobilteil (mm): L / B / H = ca. 161 x 48 x 16

Telefon-Anschluss-Schnur Belegung:

TSV auf Pin 3 und 4 gemäß CTR 37 (Euro-Belegung)

Steckernetzgerät: Eurostecker

Konformitätserklärung



Dieses Gerät erfüllt die Anforderungen der EU-Richtlinien:

- 1999/5/EG Richtlinie über Funkanlagen und Telekommunikationsend-einrichtungen und die gegenseitige Anerkennung ihrer Konformität.
- 2005/32/EG Richtlinie „Energiebetriebene Produkte“.
- Verordnung 1275/2008 „Stromverbrauch im Bereitschafts- und im Auszustand“.
- Verordnung 278/2009 „Netzteile bei Nulllast sowie ihre durchschnittliche Effizienz im Betrieb“.

Die Konformität mit den o. a. Richtlinien wird durch das CE-Zeichen auf dem Gerät bestätigt.

Für die komplette Konformitätserklärung nutzen Sie bitte den kostenlosen Download von unserer Website www.switel.com.

Pflegehinweise

Reinigen Sie die Gehäuseoberflächen mit einem weichen und fusselreifen Tuch. Verwenden Sie keine Reinigungs- oder Lösungsmittel.

Garantie

SWITEL-Geräte werden nach den modernsten Produktionsverfahren hergestellt und geprüft. Ausgesuchte Materialien und hoch entwickelte Technologien sorgen für einwandfreie Funktion und lange Lebensdauer.

Ein Garantiefall liegt nicht vor, wenn die Ursache einer Fehlfunktion des Gerätes bei dem Telefonnetzbetreiber oder einer eventuell zwischengeschalteten Nebenstellenanlage liegt. Die Garantie gilt nicht für die in den Produkten verwendeten Batterien, Akkus oder Akkupacks.

Die Garantiezeit beträgt 24 Monate, gerechnet vom Tage des Kaufs. Innerhalb der Garantiezeit werden alle Mängel, die auf Material- oder Herstellungsfehler zurückzuführen sind, kostenlos beseitigt. Der Garantieanspruch erlischt bei Eingriffen durch den Käufer oder durch Dritte. Schäden, die durch unsachgemässe Behandlung oder Bedienung, natürliche Abnut-

zung, durch falsches Aufstellen oder Aufbewahren, durch unsachgemässen Anschluss oder Installation sowie durch höhere Gewalt oder sonstige äussere Einflüsse entstehen, fallen nicht unter die Garantieleistung.

Wir behalten uns vor, bei Reklamationen die defekten Teile auszubessern, zu ersetzen oder das Gerät auszutauschen. Ausgetauschte Teile oder ausgetauschte Geräte gehen in unser Eigentum über.

Schadenersatzansprüche sind ausgeschlossen, soweit sie nicht auf Vorsatz oder grober Fahrlässigkeit des Herstellers beruhen.

Sollte Ihr Gerät dennoch einen Defekt innerhalb der Garantiezeit aufweisen, wenden Sie sich bitte unter Vorlage Ihrer Kaufquittung ausschliesslich an das Geschäft, in dem Sie Ihr SWITEL-Gerät gekauft haben. Alle Gewährleistungsansprüche nach diesen Bestimmungen sind ausschliesslich gegenüber Ihrem Fachhändler geltend zu machen. Nach Ablauf von zwei Jahren nach Kauf und Übergabe unserer Produkte können Gewährleistungsrechte nicht mehr geltend gemacht werden.

Stichwortverzeichnis

A

Akku aufladen	.6
Akku einlegen	.6
Akkus	.2
Anruf annehmen	.15
Anrufen	.15
Anrufliste	.16, 20
Audioeinstellungen	.24
Aufstellungsort	.2
Auslieferungszustand	.36
Automatische Rufannahme	.7, 26

B

Basisstation anschließen	.5
Basisstation auswählen	.26
Bereitschaftsmodus	.14
Bestimmungsgemäße Verwendung	.2

D

Datum/Uhrzeit	.6, 23
Direktannahme	.7, 26
Displaysprache	.7, 25

E

ECO-Mode	.14
Entsorgung	.3
Externes Gespräch vermitteln	.18

F

Fehlersuche	.35
-------------	-----

Flashzeit	.28
-----------	-----

G

Garantie	.38
Gespräch beenden	.15
Gesprächsdauer	.17

H

Hinweistöne	.25
Hörer-/Lautsprecherlautstärke	.17

I

Intern telefonieren	.17
---------------------	-----

K

Konferenz	.18
Konformitätserklärung	.38
Kontrast	.26

L

Ladestation	.5
Leistungsaufnahme	.4

M

Makeln	.18
Medizinische Geräte	.3
Menüstruktur	.31
Mikrofon ausschalten	.17
Mobilteil ausschalten	.19
Mobilteile an-/abmelden	.29
Mobilteilnamen	.25

Mute17

N

Navigation im Menü14

Netzteil2

P

Pflegehinweise38

PIN28

S

Sicherheitshinweise2

Strahlungsreduzierung14

Stromausfall2

Stromverbrauch4

Symbole im Display10

T

Tastensperre19

Technische Daten37

Telefonanlagen30

Telefonbuch16, 21

Tonruf24, 27

Tonruf ausschalten19

V

Verpackungsinhalt4

W

Wahlverfahren27

Wahlwiederholung16, 20

Wecker23

Werkseinstellungen36

Z

Zeichentabellen32

Zurücksetzen27, 28

Zusatzdienste30

1	Consignes de sécurité	2
2	Mettre votre téléphone en service	4
3	Éléments de manipulation	8
4	Introduction	10
5	Téléphoner	15
6	Fonctions spéciales	19
7	Liste d'appels / Répétition des derniers numéros	20
8	Répertoire	21
9	Réglage du téléphone	23
10	Déclarer/retirer un combiné	29
11	Installations à postes supplém. / services confort	30
12	Annexe	31

Consignes de sécurité

1 Consignes de sécurité

Lisez très attentivement ce mode d'emploi.

Utilisation conforme aux prescriptions

Ce téléphone convient pour téléphoner à l'intérieur d'un réseau téléphonique. Tout autre utilisation est considérée comme non conforme à l'usage. Des modifications ou changements effectués d'un propre gré ne sont pas autorisés. N'ouvrez en aucun cas l'appareil et n'effectuez aucun essai de réparation vous-même.

Lieu d'installation

Évitez toute nuisance par la fumée, la poussière, les vibrations, les produits chimiques, l'humidité, la grande chaleur ou l'ensoleillement direct.
Ne vous servez pas du combiné dans des endroits exposés aux explosions.

Bloc secteur

 **Attention:** N'utilisez que le bloc secteur fourni avec l'appareil, d'autres pouvant endommager votre téléphone. Vous ne devez pas bloquer l'accès au bloc secteur par des meubles ou d'autres objets.

Piles rechargeables

 **Attention:** Ne jetez pas les piles rechargeables dans le feu. N'utilisez que le pack de piles rechargeables fourni avec l'appareil.
Veillez à une polarisation correcte !
Risque d'explosion lors de leur chargement si la polarisation est incorrecte.

Panne de courant

En cas de panne de courant, vous ne pouvez pas téléphoner avec le téléphone. Tenez à votre disposition, pour parer à de telles situations, un téléphone filaire fonctionnant sans alimentation externe en courant.

Appareils médicaux

 **Attention:** N'utilisez pas ce téléphone à proximité d'appareils médicaux. Leur influence ne peut pas être entièrement exclue.

Les téléphones **DECT**¹ peuvent causer un bourdonnement désagréable dans les prothèses auditives.

Élimination

Si vous ne voulez plus vous servir de votre appareil, veuillez l'apporter au centre de collecte de l'organisme d'élimination des déchets de votre commune (par ex. centre de recyclage). L'icône ci-contre signifie que vous ne devez en aucun cas jeter votre appareil dans les ordures ménagères ! D'après la loi relative aux **appareils électriques et électroniques**, les propriétaires d'appareils usagés sont tenus de mettre tous les appareils électriques et électroniques usagés dans un collecteur séparé.

Éliminez les piles rechargeables auprès d'un revendeur de piles ainsi que dans des centres de collecte compétents qui tiennent à votre disposition les collecteurs appropriés correspondants.

Éliminez les **fournitures d'emballage** conformément au règlement local.



¹ DECT: **D**igital **E**nanced **C**ordless **T**elecommunication = Standard pour les téléphones sans fil.

Mettre votre téléphone en service

2 Mettre votre téléphone en service

Remarques concernant la sécurité

 **Attention:** Avant de mettre votre appareil en service, lisez impérativement les consignes de sécurité mentionnées au chapitre 1.

Contrôler le contenu de l'emballage

Les éléments suivants font partie de la livraison :

Contenu	Modèle DF 86x			
	861	862 ¹	863 ¹	864 ¹
Base avec bloc d'alimentation	1	1	1	1
Chargeur avec bloc d'alimentation	-	1	2	3
Combiné	1	2	3	4
Câble de raccord. téléphonique	1	1	1	1
Pack de piles rechargeables	1	2	3	4
Mode d'emploi	1	1	1	1

¹ À l'adresse www.switel.com, vous apprendrez si ce kit téléphonique est déjà disponible à la vente.

Puissance absorbée

Puissance absorbée de la station de base :

- en mode de fonctionnement (disponible/conversation) : env. 1,2 W
- pendant le chargement du combiné : env. 2 W.

Sans charge, le courant d'alimentation à découpage entrant s'élève à env. 0,15 W. Le rendement moyen est d'env. 60 %.

Puissance absorbée de la station de chargement :

- sans le combiné : env. 0,15 W
- pendant le chargement du combiné : env. 1,2 W.

Sans charge, le courant d'alimentation à découpage entrant s'élève à env. 0,15 W. Le rendement moyen est d'env. 60 %.

Raccorder la base

⚠ Attention: Posez la base à une distance minimum d'1 m par rapport à d'autres appareils électroniques, une distance inférieure pouvant provoquer des interactions.

Raccordez la base comme représenté sur le croquis. Pour des raisons de sécurité, n'utilisez que le bloc d'alimentation fourni avec l'appareil ainsi que le câble de raccordement téléphonique ci-joint.

Prise de raccordement téléphonique

Prise réseau

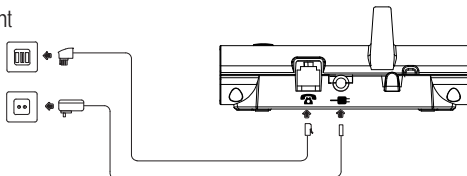

⚠ Attention: N'utilisez pour la base que le bloc d'alimentation S002CV0600030 / 6V, 300 mA DC fourni avec l'appareil !

Raccorder le chargeur ²

Raccordez le chargeur comme représenté sur le croquis. Pour des raisons de sécurité, n'utilisez que le bloc d'alimentation fourni avec l'appareil.

Prise réseau

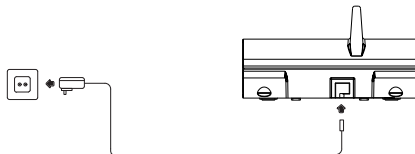

⚠ Attention: N'utilisez pour le chargeur que le bloc d'alimentation S002CV0600030 / 6 V, 300 mA DC fourni avec l'appareil !

² N'est valable que pour les kits téléphoniques avec au moins deux combinés, -> « Contrôler le contenu de l'emballage ».

Mettre votre téléphone en service

Mettre en place les piles rechargeables

Ouvrez le compartiment à piles.
Enfoncez la fiche du pack de piles rechargeables dans la prise située dans le compartiment à piles. Insérez le pack de piles rechargeables dans le compartiment à piles.
Fermez le compartiment à piles.

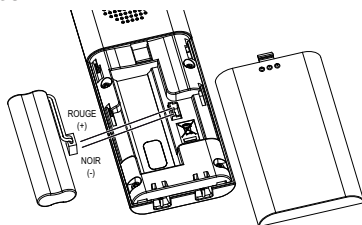

⚠ Attention: N'utilisez que le pack de piles rechargeables fourni avec l'appareil 2,4 V, 500 mAh, NiMH!. Observez une polarisation correcte !

Recharger les piles rechargeables

👉 Pour la première mise en service, posez le combiné sur la base / le chargeur pour une durée d'au moins 14 heures.

Le combiné chauffe lors du chargement. C'est normal et ce n'est pas dangereux. Ne chargez pas le combiné avec des chargeurs d'un autre fabricant. L'état de charge des piles rechargeables est indiqué sur l'écran. Lorsque le chargement des piles rechargeables a atteint la limite inférieure, le symbole de la pile (🔋) clignote sur l'écran et vous entendez l'alerte sonore des piles (si l'alerte sonore des piles est activée/via le menu « Réglages Combiné / Alertes Sonores / Batterie faible »). Vous avez encore un temps de communication d'env. 10 minutes.

Réglage de la date et de l'heure

Lors de la mise en service, le combiné n'est pas réglé à l'heure correcte (p. ex. pour les entrées de la liste d'appels). Vous réglez la date et l'heure via le menu « Heure/Alarme / Date & Heure ».

Paramétrer la langue de l'écran

La langue de l'écran est réglable en 4 langues différentes. Dans son état à la livraison, elle est réglée sur « Allemand ». Vous pouvez changer la langue via le menu « MT einstellen / Sprache ».

Prise d'appel automatique / Réponse autom.

Si vous avez activé la fonction, l'appel sera automatiquement réceptionné quand vous prendrez le combiné de la base. La prise d'appel automatique s'active ou se désactive via le menu « Réglages Combiné / Réponse auto ».

3 Éléments de manipulation

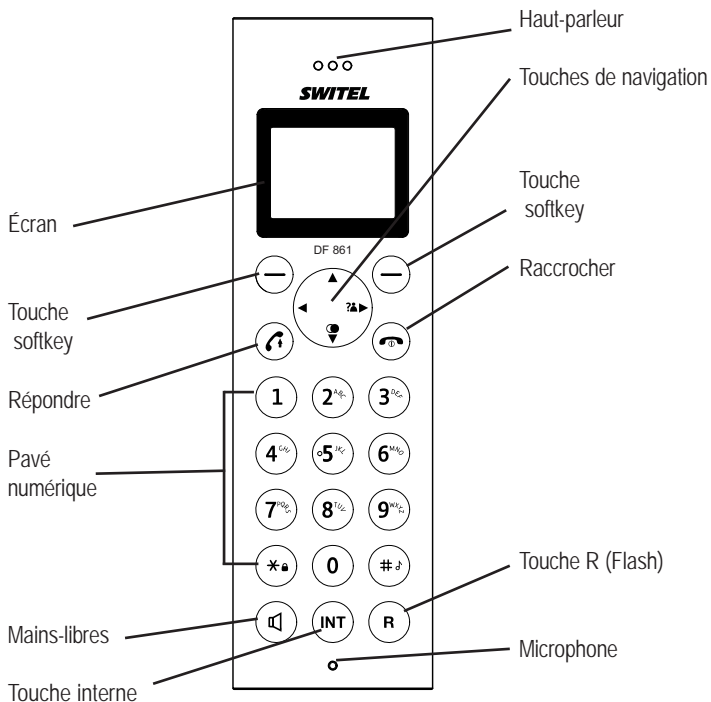

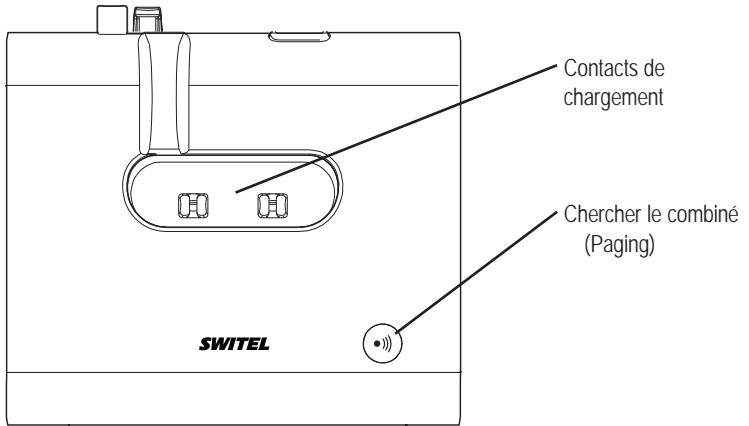















4 Introduction

Dans ce chapitre, vous trouverez des informations de base vous expliquant comment vous servir du mode d'emploi et du téléphone.

Mode de représentation dans le mode d'emploi

Visualisation	Description
	Appuyer sur la touche représentée
	Saisir des chiffres ou des lettres
	Le combiné sonne
	La base sonne
	Prendre le combiné de la base
	Poser le combiné sur la base
Name?	Visualisation des textes de l'écran
	Visualisation des icônes de l'écran

Icônes à l'écran du combiné

Icône	Description
	Constant : la liaison avec la base est bonne.
	Clignotant : la liaison avec la base s'interrompt. Constant : affichage de la capacité des piles.
	Segments continus quand le combiné est sur la base : Les piles rechargeables se rechargent.
	Certains segments ne sont pas affichés : les piles rechargeables devraient être chargées.
	Clignotant : chargez les piles rechargeables. Constant : Vous téléphonez.
	Clignotant : Le téléphone sonne.
	Le mode mains-libres est activé. La sonnerie d'appel est désactivée.



Constant : la fonction d'alarme est activée.

Clignotant : alarme.



Le verrouillage du clavier est activé.



Vous tenez une communication interne (uniquement si base avec plusieurs combinés).

Réception d'un message interne.



Quand affichage de la liste d'appels: nouvel appel



Autres chiffres/lettres affichées avant ou après les actuelles. Pour les afficher, appuyez sur la touche de navigation correspondante.

Dans les lignes de l'écran ci-dessous sont indiquées les fonctions disponibles liées aux deux **touches softkeys** dépendamment de l'état de fonctionnement.

Menu

Ouvrir le menu principal.

Répert

Ouvrir le répertoire

Sélect

Ouvrir le menu affiché.

OK

Confirmation d'un réglage.

Retour

Retour au menu supérieur ou interruption de la programmation.

Efface

Effacer à reculons les signes de l'entrée (une pression courte efface le dernier signe, une pression longue efface la ligne entière)

Fonctions des touches de navigation



Dans le menu / dans les listes (répertoire, liste d'appels, répétition des derniers numéros) : feuilleter plus haut.

Pendant une communication : augmenter le volume.



Pendant l'utilisation d'entrées / lors de la préparation de l'appel : déplacer le curseur vers la gauche.



En mode veille : ouvrir la liste d'appels.

Pendant l'utilisation d'entrées / lors de la préparation de l'appel : déplacer le curseur vers la droite.



En mode veille : ouvrir la liste de répétition des derniers numéros.

Pendant une communication : diminuer le volume.

Dans le menu / dans les listes (répertoire, liste d'appels, répétition des derniers numéros) : feuilleter plus bas.

Fonctions particulières de certaines touches



Pendant l'entrée du numéro : une pression longue introduit une pause.



En mode veille : une pression longue de la touche active/désactive le verrouillage des touches.

Pendant l'entrée d'un nom : une pression longue de la touche change le caractère (latin/russe/grec), Tableaux voir Annexe.

Pendant une liaison : changement temporaire sur la numérotation par tonalité quand la numérotation par impulsion est activée.



En mode veille : une pression longue de la touche active/désactive la sonnerie du combiné.

Pendant l'entrée d'un nom : une pression longue change entre majuscules et minuscules.

Mode veille

Toutes les descriptions dans ce mode d'emploi partent du principe que le combiné se trouve en mode veille. Vous parviendrez au mode veille en appuyant sur la touche .

Réduction du rayonnement (mode ÉCO)



En comparaison avec les téléphones sans fil DECT standard, le rayonnement est considérablement réduit en mode de communication.

Navigation dans le menu

Vous pouvez accéder à toutes les fonctions via différents menus. Vous trouvez la structure complète du menu dans l'annexe.

Pour naviguer dans le menu, utilisez les touches softkeys et fléchées.

Avec touche softkey **Menu**, vous ouvrez le menu.

Avec les touches fléchées  ou , vous naviguez dans le menu.

Pour ouvrir un sous-menu, appuyez sur la touche softkey **Sélect**.

Si vous voulez revenir au menu supérieur, appuyez brièvement sur **Retour**.

Par pression de la touche raccrocher, vous vous retrouvez de nouveau en mode veille.

5 Téléphoner

Prendre l'appel

  Votre téléphone sonne.

Si le combiné **ne** se trouve pas sur la base:

 /  Appuyez sur la touche décrocher ou la touche mains-libres.

Si le combiné se trouve sur la base et **Réponse Auto n'est** pas activé:

 /  Prenez le combiné de la base et appuyez sur la touche décrocher ou la touche mains-libres.

Si le combiné se trouve sur la base et **Réponse Auto** est activé:

 Prenez simplement le combiné de la base ; la communication est réceptionnée automatiquement.

Appeler



Entrez le numéro de téléphone.

Corrigez une erreur d'entrée avec **Efface**.



Le numéro de téléphone est composé.

 Vous pouvez aussi appuyer d'abord sur la touche communication et vous obtenez ainsi la tonalité. Les chiffres entrés du numéro de téléphone choisi sont aussitôt composés. Il n'est pas possible de corriger les chiffres du numéro de de téléphone dans cette forme de mise en communication.

Terminer la communication



Appuyer sur la touche décrocher ou poser le combiné sur la base.

Répétition des derniers numéros

 Votre téléphone mémorise les 20 derniers numéros de téléphone composés. Si le numéro de téléphone est mémorisé dans le répertoire, le nom s'affiche. Pour afficher le numéro de téléphone correspondant, appuyez sur la touche **Sélect**.



Ouvrir la liste de répétition des derniers numéros.



Sélectionner l'enregistrement.



Le numéro est composé.

Appeler depuis la liste d'appels

 Votre téléphone mémorise les 30 derniers appels dans la liste d'appels. Si le numéro de téléphone est mémorisé dans le répertoire, le nom s'affiche. Pour afficher le numéro de téléphone correspondant, appuyez sur la touche **Sélect**. L'enregistrement ne peut avoir lieu que si la fonction « transfert d'appel (CLIP) » est disponible sur votre raccordement et le numéro de l'appelant n'a pas été retenu ou rendu non transmissible pour d'autres raisons.



Ouvrir la liste d'appels.



Sélectionner l'enregistrement.



Le numéro est composé.

Appeler depuis le répertoire

 Le répertoire peut recevoir 100 entrées. Pour mémoriser des entrées voir le paragraphe « Répertoire ».

Répert

Ouvrir le répertoire.



Sélectionner l'enregistrement.



Le numéro est composé.

Affichage de la durée de la communication

Pendant une communication, sa durée est affichée en heures, minutes et secondes.

Régler le volume sonore de l'écouteur



Vous disposez de 5 niveaux pour régler le volume pendant une communication (sous fonctionnement de l'écouteur-> Volume sonore de l'écouteur, en mains-libres -> volume sonore du haut-parleur).

Les réglages sont indépendants les uns des autres et restent mémorisés même après fin de la communication.

Débranchement du microphone du combiné

Muet

Vous pouvez désactiver le microphone pendant une communication afin que votre interlocuteur ne puisse pas vous déranger. **Muet** s'affiche sur l'écran.

Parler

Pour activer le microphone, appuyez de nouveau sur la touche.

Téléphoner en interne

 Communication internes, transferts et communications en conférence sont possibles uniquement si plusieurs combinés sont déclarés. Si ce n'est pas le cas, **Indisponible** s'affichera sur l'écran.

Téléphoner en interne

INT

Appuyez la touche **INT**. Si deux combinés sont déclarés, l'autre combiné est aussitôt appelé. Dans le cas de plusieurs combinés déclarés, leurs numéros internes s'affichent (p. ex. 2 3 4). Sélectionnez le combiné souhaité avec la touche fléchée  /  et appuyez sur **Sélect**. Si vous sélectionnez « 9 » dans le cas de plusieurs combinés déclarés, tous sont appelés simultanément.

Transfert d'une communication externe

INT

Pendant une communication externe. . .

Appuyez la touche **INT**.

Sélectionnez le combiné souhaité avec la touche fléchée

 /  et appuyer sur **Sélect.**

La communication externe est maintenue.

Si le combiné appelé est activé, annoncer la communication le cas échéant.



Appuyez sur la touche raccrocher. La communication est transmise.

Va-et-vient

INT

Pendant une communication externe. . .

Appuyez la touche **INT**.

Sélectionnez le combiné souhaité avec la touche fléchée

 /  et appuyer sur **Sélect.**

La communication externe est maintenue.

INT

Avec la touche **Int** vous passez d'un interlocuteur à l'autre.

Conférence

INT

Pendant le va-et-vient (s. o.) . . .

Vous parlez avec un autre participant interne :

Appuyez et maintenez la touche **Int** jusqu'à l'apparition de **Conférence** sur l'écran.

 i l'un des participants à la conférence raccroche, les deux autres restent en communication.

6 Fonctions spéciales

Verrouillage du clavier

 La touche verrouillage empêche une manipulation involontaire des touches. Les appels peuvent être reçus comme d'habitude.



Appuyez et maintenez la touche étoile jusqu'à l'apparition du symbole de verrouillage des touches.



Pour déverrouiller le clavier, appuyez et maintenez de nouveau la touche étoile jusqu'à la disparition du symbole.

Désactiver la sonnerie du combiné

 Vous pouvez désactiver la sonnerie d'appel aussi via le menu « Réglages Combiné / Réglages sonn. / Volume Sonnerie ».



Appuyez et maintenez la touche dièse jusqu'à l'apparition du symbole de désactivation de la sonnerie d'appel .



Pour réactiver la sonnerie d'appel, appuyez et maintenez de nouveau la touche dièse jusqu'à disparition du symbole.

Désactiver le combiné

 Vous pouvez désactiver le combiné pour économiser les piles rechargeables.



Appuyez sur raccrocher et maintenez la touche appuyée. Après quelques secondes, le combiné est désactivé. L'éclairage de l'écran s'éteint.



Pour réactiver le combiné, appuyez sur la touche raccrocher jusqu'à ce que vous entendiez le signal sonore et que l'écran s'éclaire de nouveau.

Liste d'appels / Répétition des derniers numéros

7 Liste d'appels / Répétition des derniers numéros

Utiliser la liste d'appels



Ouvrez la liste d'appels.



Sélectionnez une entrée et appuyez sur **Sélect**. Date et heure de l'appel sont affichées.

Menu

Appuyez sur touche softkey **Menu**.



Sélectionnez l'une des options suivantes et confirmez avec **Sélect**:



Ajouter au rép. Le numéro est enregistré dans le répertoire. Entrez le nom, confirmez ou modifiez le numéro et fixez une mélodie sonore pour cette entrée.

Effacer L'entrée est effacée après une question de sécurité.

Tout effacer La liste complète est effacée après une question de sécurité.



Vous pouvez ouvrir la liste d'appels aussi via le menu:

(Menu  /  **Liste des appels / Appels Reçus / Sélect**).

Utiliser la répétition des derniers numéros



Ouvrir la répétition des derniers numéros.



Sélectionnez une entrée et appuyez sur **Sélect**.

Menu

Appuyez sur touche softkey **Menu**.



Sélectionnez l'une des options suivantes et confirmez avec **Sélect**:

Ajouter au rép. Le numéro est enregistré dans le répertoire. Entrez le nom, confirmez ou modifiez le numéro et fixez une mélodie sonore pour cette entrée.

Effacer L'entrée est effacée après une question de sécurité.

Tout effacer La liste complète est effacée après une question de sécurité.

8 Répertoire

☞ Dans le répertoire, vous pouvez mémoriser 100 numéros et noms correspondants. Vous pouvez associer à chaque entrée une mélodie propre par laquelle un appel doit être signalé. Entrez toujours les numéros avec le préfixe ; ceci permet un affichage correct de chaque appelant dont il existe une entrée et dont le transfert de numéro à votre raccordement est disponible.

Saisir une nouvelle entrée

Menu

Appuyez sur touche softkey **Menu**.



Sélectionner **Répertoire** et confirmer sur **Sélect**.



Le cas échéant, sélectionner **Ajouter** et appuyer sur **Sélect**.



Entrez le nom (12 signes maximum).

Les touches de chiffres comportent des lettres.

Lettres et chiffres peuvent être entrés par pressions répétées de la touche correspondante.

Une pression longue de la touche # change entre majuscules et minuscules.

Après peu de temps, le curseur se déplace vers la droite.

Terminez l'entrée du nom avec .



Entrez le numéro (24 chiffres maximum). Si votre téléphone est raccordé à une installation téléphonique, entrez aussi le code d'identification. Si une pause est nécessaire, après le code d'identification, appuyez sur la touche **0** pendant env. 2 s ; **P** s'affiche sur l'écran.

Terminez l'entrée du numéro avec .







Sélectionnez une mélodie pour l'entrée.

OK

Confirmez avec **OK**.

Utiliser les entrées du répertoire

- Menu** Appuyez sur touche softkey **Menu**.
-  /  Sélectionner **Répertoire** et confirmer sur **Sélect**.
-  /  Sélectionnez l'une des options suivantes et confirmez avec **Sélect**:
- Voir** Toutes les entrées sont affichées. Feuilletez jusqu'à l'entrée souhaitée. Avec **Sélect**, vous voyez le nom, le numéro de téléphone et la mélodie. Avec **Menu**, vous pouvez modifier ou effacer l'entrée.
- Ajouter** Vous pouvez effectuer une nouvelle entrée.
- Editer** Toutes les entrées sont affichées. Feuilletez jusqu'à l'entrée souhaitée. Après **Sélect**, vous pouvez modifier l'entrée. Effacez les lettres et chiffres avec **Efface**, entrez de nouvelles lettres et chiffres avec les touches de chiffres. Pour plus de détails, voir « insérer nouvelle entrée ».
- Effacer** Toutes les entrées sont affichées. Feuilletez jusqu'à l'entrée souhaitée. Après **Sélect** l'entrée est effacée.
- Tout effacer** Après **Sélect**, le répertoire entier est effacé après une question de sécurité.
- Etat répertoire** La configuration actuelle est affichée (p. ex. **07/100 Occ.**: 7 sur 100 entrées possibles sont existantes).

9 Réglage du téléphone

Date/heure

Menu



Appuyez sur touche softkey **Menu**.

Sélectionnez **Heure/Alarme** et appuyer sur **Sélect**.

Sélectionnez **Date & Heure** et appuyer sur **Sélect**.

Sélectionnez l'une des options suivantes et confirmez avec **Sélect**:

Format date

Vous pouvez régler la représentation de la date :
(JJ-MM-AAAA ou MM-JJ-AAAA).

Format Heure

Vous pouvez régler la représentation de l'heure:
(24 heures ou 12 heures).

Réglage Date

Entrez l'heure avec les touches de chiffres.

Réglage Heure

Entrez la date avec les touches de chiffres. Pour une entrée en format de 12h, changez avec la touche étoile entre « AM » et « PM ».

 En cas de panne de courant, le réglage est perdu si le combiné est désactivé en même temps ou les piles rechargeables sont vides.

Réveil

Menu



Appuyez sur touche softkey **Menu**.

Sélectionnez **Heure/Alarme** et appuyer sur **Sélect**.

Sélectionnez **Alarme** et appuyer sur **Sélect**.

Sélectionnez **Alarme On** et appuyer sur **Sélect**.

Entrez l'heure de réveil avec les touches de chiffres et appuyez sur **OK**.



Sélectionnez **Snoozeon** ou **Snoozeoff** et appuyez sur **Sélect**.

Si « Snooze » est activé, cela signifie que le signal de réveil sera répété après 2 minutes, jusqu'à ce que cette fonction soit arrêtée par pression et maintien de la touche raccrocher.

Réglage du téléphone

Si « Snooze » est désactivé, le signal de réveil retentira une seule fois à l'heure fixée. Pour quitter le signal de réveil, appuyez sur une touche quelconque.



Sélectionnez **Sonnerie alarme** et appuyez sur **Sélect.**

Sélectionnez une mélodie et appuyez sur **Sélect.**

Réglages audio du combiné

Menu

Appuyez sur touche softkey **Menu**.



Sélectionnez **Réglages Combiné** et appuyez sur **Sélect.**

Sélectionnez **Réglages audio** et appuyez sur **Sélect.**

Sélectionnez l'une des options suivantes et confirmez avec **Sélect.**

Vol. H-parleur

Sélectionnez le volume pour la lecture en fonctionnement mains-libres.

Volume d'écoute

Sélectionnez le volume de l'écouteur.

 Vous pouvez aussi effectuer simplement ces réglages pendant une communication avec les touches fléchées (s. « Téléphoner / Régler le volume sonore de l'écouteur »)

Régler la sonnerie du combiné

Menu

Appuyez sur touche softkey **Menu**.



Sélectionnez **Réglages Combiné** et appuyez sur **Sélect.**

Sélectionnez **Réglages sonn.** et appuyez sur **Sélect.**

Sélectionnez l'une des options suivantes et confirmez avec **Sélect.**

Sonnerie Interne

Sélectionnez une mélodie pour la signalisation d'un appel interne.

Sonnerie Externe

Sélectionnez une mélodie pour la signalisation d'un appel externe.

Volume Sonnerie

Sélectionnez le volume de la sonnerie. Sélectionnez « **Volume off** », le symbole s'affiche sur l'écran.

Régler la tonalité d'information

Menu



Appuyez sur touche softkey **Menu**.



Sélectionnez **Réglages Combiné** et appuyez sur **Sélect**.



Sélectionnez **Alertes Sonores** et appuyez sur **Sélect**.

Sélectionnez l'une des options suivantes et confirmez avec **Sélect**:

Bip touches

Activez ou désactivez la tonalité de confirmation pour l'activation d'une touche.

Batterie faible

Activez ou désactivez la tonalité d'information spéciale. La tonalité signale quand les piles rechargeables doivent être chargées.

Hors Portée

Activez ou désactivez la tonalité d'information spéciale. La tonalité signale quand vous vous trouvez avec le combiné à la limite de portée de la base.

Régler la langue de l'écran

Menu



Appuyez sur touche softkey **Menu**.



Sélectionnez **Réglages Combiné** et appuyez sur **Sélect**.



Sélectionnez **Langue** et appuyez sur **Sélect**.

Sélectionnez une langue et confirmez avec **Sélect**.

Régler le nom du combiné

Menu



Appuyez sur touche softkey **Menu**.



Sélectionnez **Réglages Combiné** et appuyez sur **Sélect**.

Sélectionnez **Renommer combiné** et appuyez sur **Sélect**.



Effacez l'ancien nom avec **Efface**, entrez le nouveau nom avec les touches de chiffres et appuyez sur **OK**.

Réglage du contraste

Menu



Appuyez sur touche softkey **Menu**.



Sélectionnez **Réglages Combiné** et appuyez sur **Sélect**.



Sélectionnez **Contraste** et appuyez sur **Sélect**.

Sélectionnez le contraste souhaité et appuyez sur **Sélect**.

Réglage de la réponse d'appel automatique

Menu



Appuyez sur touche softkey **Menu**.



Sélectionnez **Réglages Combiné** et appuyez sur **Sélect**.



Sélectionnez **Réponse auto** et appuyez sur **Sélect**.

Choisissez si la réponse automatique doit être activée ou désactivée et confirmez avec **Sélect**.

Lorsque la réponse automatique est activée, un appel est aussitôt réceptionné quand le combiné est pris de la base.

Sélectionner la base

Menu



Appuyez sur touche softkey **Menu**.



Sélectionnez **Réglages Combiné** et appuyez sur **Sélect**.



Sélectionnez **Choix base** et appuyez sur **Sélect**.

Vous voyez une liste des bases auxquelles le combiné a été déclaré. La base activée actuellement est caractérisée par une « * ». Sélectionnez une base et appuyez sur **Sélect**.

Seules sont indiquées les bases auxquelles le combiné a déjà été enregistré.

Remettre le combiné dans l'état à la livraison

Menu



Appuyez sur touche softkey **Menu**.



Sélectionnez **Réglages Combiné** et appuyer sur **Sélect.**



Sélectionnez **Rég. CB Défaut** et appuyer sur **Sélect.**

Entrez le PIN actuel et appuyez sur **OK**.

Confirmez aussi la question de sécurité suivante avec **OK**.

Les entrées du répertoire ne sont pas effacés.

Régler la sonnerie de la base

Menu



Appuyez sur touche softkey **Menu**.



Sélectionnez **Réglages Base** et appuyer sur **Sélect.**



Sélectionnez **Réglages sonn.** et appuyez sur **OK**.

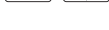

Sélectionnez l'une des options suivantes et confirmez avec

Sélect:

Sonnerie

Sélectionnez une mélodie pour la signalisation d'un appel.

Volume Sonnerie

Sélectionnez le volume ou désactivez la sonnerie.

Régler le processus de numérotation

Menu



Appuyez sur touche softkey **Menu**.



Sélectionnez **Réglages Base** et appuyer sur **Sélect.**



Sélectionnez **Numérotation** et appuyez sur **Sélect.**

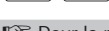

Sélectionnez **FV** ou **DC** et confirmez avec **Sélect.**

Pour la plupart des raccords, le réglage correct est FV.

Réglage du téléphone

Réglez le temps de flash

Menu



Appuyez sur touche softkey **Menu**.



Sélectionnez **Réglages Base** et appuyer sur **Sélect.**



Sélectionnez **Touche R** et appuyez sur **Sélect.**

Sélectionnez Court (100 ms), Medium (300 ms) ou Long (600 ms) et confirmez avec **Sélect.**

Modifier le PIN

Menu



Appuyez sur touche softkey **Menu**.



Sélectionnez **Réglages Base** et appuyer sur **Sélect.**



Sélectionnez **Modifier PIN** et appuyez sur **Sélect.**



Entrez le PIN actuel

(Etat à la livraison : 0 0 0 0) et appuyez sur **OK**.



Entrez un nouveau PIN et appuyez sur **OK**.



Entrez le nouveau PIN une nouvelle fois et appuyez sur **OK**.

 Le PIN à quatre chiffres protège quelques réglages contre un accès non autorisé. Si vous avez oublié le PIN, merci de vous adresser à notre service hotline.

Remettre la base comme à l'état de livraison

Menu



Appuyez sur touche softkey **Menu**.



Sélectionnez **Réglages Base** et appuyer sur **Sélect.**



Sélectionnez **Rég. défaut base** et appuyez sur **Sélect.**

Entrez le PIN actuel et appuyez sur **OK**.

Confirmez aussi la question de sécurité suivante avec **OK**.

 Les entrées du répertoire ne sont pas effacées.
Les combinés déclarés restent déclarés.

10 Déclarer/retirer un combiné

Sur une base, vous pouvez déclarer jusqu'à 5 combinés. Les combinés livrés avec votre téléphone sont déjà déclarés sur la base. Pour déclarer un combiné « étranger », consultez aussi la notice d'utilisation de ce combiné.

Déclarer un autre combiné du même type

Menu



Appuyez sur touche softkey **Menu**.

Sélectionnez **Association** et appuyez sur **Sélect**.

Sélectionnez une base et appuyez **Sélect**. Les bases auprès desquelles le mobile est déjà inscrit sont représentées en caractères à jour. La base actuelle est caractérisée par un *.



Entrez le PIN actuel de la base sur laquelle le combiné doit être déclaré et appuyez sur **OK**.



Appuyez et maintenez la touche Paging sur la base jusqu'à ce que la tonalité d'activation soit audible (env. 5 s).

Peu de temps après, le symbole de l'antenne est éclairé, constant, sur l'écran et le combiné est déclaré.

Retirer le combiné

Menu



Appuyez sur touche softkey **Menu**.

Sélectionnez **Réglages Base** et appuyez sur **Sélect**.



Sélectionnez **Annuler Combiné** et appuyez sur **Sélect**.



Entrez le PIN actuel et appuyez sur **Ok**.



Sélectionnez l'un des combinés indiqués et appuyez sur **Sélect**.



Le combiné que vous utilisez en ce moment ne peut pas être annulé.

Installations à postes supplém. / services confort

11 Installations à postes supplém. / services confort

Installations à postes supplémentaires

Si votre téléphone est raccordé à une installation à postes supplémentaires, vous pouvez au moyen de la touche R tirer profit de certaines fonctions comme par ex. le transfert d'appels et le rappel automatique. Veuillez lire le mode d'emploi de votre installation à postes supplémentaires pour connaître le temps de flash à paramétrer pour tirer profit de ces fonctions.

Votre revendeur, auprès duquel vous avez acheté l'installation, vous informera si votre téléphone fonctionne impeccablement sur ce genre d'installation.

Merci de penser le cas échéant, pour les entrées dans le répertoire, au code d'identification et à la pause parfois nécessaire lui succédant (appuyer longuement sur le chiffre « 0 »).

Services confort

Votre téléphone supporte les services confort de votre opérateur, comme par ex. le va-et-vient, la signalisation d'appel en instance et la conférence.

Via la touche R vous pouvez tirer profit de ces services confort. Veuillez demander à votre opérateur quel temps de flash vous devez paramétrer pour tirer profit des services confort. Adressez-vous également à lui pour la déconnexion de ces services.

12 Annexe

Structure du menu



Tableau de caractères

Caractères latins / majuscules

0	SP	0	-	+	=	_	()	"	'	[]	{	}	<	>	/	\	^	~	
1	1	.	,	:	;	!	ı	?	ı	*	#	&	%	\$	€	£	@	¤	§		
2	A	B	C	2	À	Á	Â	Ã	Ä	Å	Ą	Æ	Ç	Ć	Č						
3	D	E	F	3	Ď	È	É	Ê	Ë	Ę	Ě	Ě									
4	G	H	I	4	Ğ	Ì	Í	Î	Ï	Ī	Ī	Ī									
5	J	K	L	5	Ł	Ł	Ł														
6	M	N	O	6	Ñ	Ń	Ń	Ò	Ó	Ô	Õ	Ö	Õ	Ö	Ø						
7	P	Q	R	7	Ř	Ŕ	Ś	Ş	Š	ß											
8	T	U	V	8	Ť	Ù	Ú	Û	Ü	Ū	Ū	Ū									
9	W	X	Y	Z	9	Ŵ	Ŷ	Ý	Ÿ	Ž	Ž	Ž									

Caractères latins / minuscules

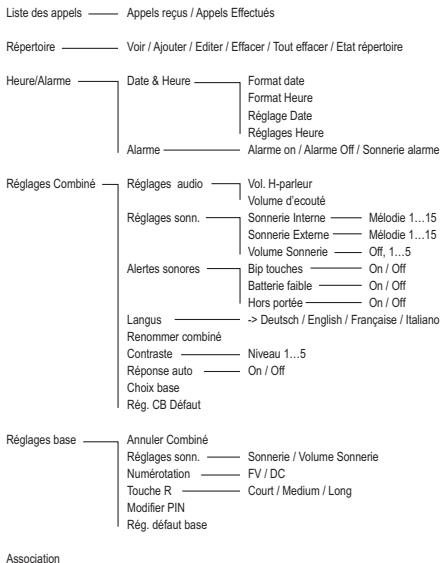
0	SP	0	-	+	=	_	()	"	'	[]	{	}	<	>	/	\	^	~	
1	1	.	,	:	;	!	ı	?	ı	*	#	&	%	\$	€	£	@	¤	§		
2	a	b	c	2	à	á	â	ã	ä	å	ą	æ	ç	ć	č						
3	d	e	f	3	ď	è	é	ê	ë	ę	ě	ě									
4	g	h	i	4	ğ	ì	í	î	ï	ĭ	ĭ	ĭ									
5	j	k	l	5	ł	ł	ł														
6	m	n	o	6	ñ	ń	ń	ò	ó	ô	õ	ö	õ	ö	ø						
7	p	q	r	s	7	ř	ŕ	ś	ş	š	ß										
8	t	u	v	8	ť	ù	ú	û	ü	ū	ū	ū									
9	w	x	y	z	9	ŵ	ŷ	ý	ÿ	ž	ž	ž									

Caractères russes / majuscules

0	SP	0	-	+	=	_	()	"	'	[]	{	}	<	>	/	\	^	~	
1	1	.	,	:	;	!	і	?	¿	*	#	&	%	\$	€	£	@	¤	§		
2	А	Б	В	Г	2																
3	Д	Е	Ж	З	3																
4	И	Й	К	Л	4																
5	М	Н	О	П	5																
6	Р	С	Т	У	6																
7	Ф	Х	Ц	Ч	7																
8	Ш	Щ	Ъ	Ы	8																
9	Ь	Э	Ю	Я	9																

Caractères russes / minuscules

0	SP	0	-	+	=	_	()	"	'	[]	{	}	<	>	/	\	^	~	
1	1	.	,	:	;	!	і	?	¿	*	#	&	%	\$	€	£	@	¤	§		
2	а	б	в	г	2																
3	д	е	ж	з	3																
4	и	й	к	л	4																
5	м	н	о	п	5																
6	р	с	т	у	6																
7	ф	х	ц	ч	7																
8	ш	щ	ъ	ы	8																
9	ь	э	ю	я	9																

Annexe

Caractères grecs / majuscules

0	SP	0	-	+	=	_	()	"	'	[]	{	}	<	>	/	\	^	~	
1	1	.	.	:	:	!	!	?	¿	*	#	&	%	\$	@	£	@	¤	§		
2	A	B	Γ	2																	
3	Δ	E	Z	3																	
4	H	Θ	I	4																	
5	K	Λ	M	5																	
6	N	Ξ	O	6																	
7	Π	P	Σ	7																	
8	T	Υ	Φ	8																	
9	X	Ψ	Ω	9																	

Caractères grecs / minuscules

0	SP	0	-	+	=	_	()	"	'	[]	{	}	<	>	/	\	^	~	
1	1	.	.	:	:	!	!	?	¿	*	#	&	%	\$	@	£	@	¤	§		
2	α	β	γ	2																	
3	δ	ε	ζ	3																	
4	η	θ	ι	4																	
5	κ	λ	μ	5																	
6	ν	ξ	ο	6																	
7	π	ρ	ς	σ	7																
8	τ	υ	φ	8																	
9	χ	ψ	ω	9																	

Recherche erronée

Si vous avez des problèmes avec votre téléphone, contrôlez d'abord les indications suivantes. En cas de problèmes techniques, vous pouvez vous adresser à notre hotline de service en appelant le numéro 0900 00 1675 en Suisse (frais Swisscom à la date d'impression de ce manuel : CHF 2.60/min). Si vous jouissez des droits de garantie, adressez-vous à votre revendeur. La durée de la garantie est de 2 ans.

- Après activation de la touche décrocher, aucune tonalité n'est audible, la ligne d'appel n'est pas occupée.
 - Contrôler la fiche du raccordement téléphonique de la base et de la prise de téléphone.
 - Contrôler la prise réseau à la base et les 230 V.
 - La ligne d'appel est occupée par un autre combiné. Patientez jusqu'à ce que la liaison soit terminée.
- Affichage de l'écran : « Recherche ».
 - Contrôler la prise réseau à la base et les 230 V.
 - Réduire distance.
 - Déclarer combiné.
- Base ne sonne pas.
 - Sonnerie désactivée -> activer.
- Aucun affichage sur l'écran.
 - Combiné désactivé -> activer.
 - Pile vide -> recharger.

Configuration d'origine/Etat à la livraison

Liste d'appels	vide
Repertoire	vide
Alarme	êteint
Sonnerie combine	Externe Melodie 1 Interne Melodie 2 Vol. sonnerie 3
Sonnerie base	Melodie 1 Vol. sonnerie 3
Alertes son.	Bips touches: en service Batt. faible: en service Hors portée: en service
Langue	Allemand
Nom combine	DF 86x
Reponse auto	en service
Date & Heure	Format date: JJ-MM-AAAA Format heure: 24 heures
Mode de numerotation	Tonalité
Temps Flash	Court (100 ms)

Caractéristiques techniques

Standard : DECT / GAP

Nombre de canaux : 120 canaux duplex

Fréquences : 1880 MHz jusqu'à 1900 MHz

Processus duplex : multiplexage par répartition dans le temps (MRT),

10ms longueur de marge

Trame canaux : 1728 kHz

Débit binaire : 1152 kbits / s

Modulation : GFSK

Codage langue : 32 kbits / s

Puissance d'émission : 10 mW (puissance moyenne par canal)

Portée: jusqu'à 300 mètres en champ libre,

jusqu'à 50 mètres à l'intérieur d'un bâtiment

Alimentation en courant de la base :

100-240 V AC (bloc d'alimentation S002CV0600030), 6 V DC / 300 mA

Alimentation de courant chargeur :

100-240 V AC (bloc d'alimentation S002CV0600030), 6 V DC / 300 mA

Durée de service combiné : en veille / en communication :

500 mAh : env. 100 h / env. 10 h

Temps de charge des piles rechargeables : env. 14 heures

Conditions ambiantes admissibles pour le fonctionnement du combiné :

5°C jusqu'à 40°C ; 20 % jusqu'à 75 % d'humidité relative

Conditions ambiantes admissibles pour le fonctionnement de la base :

5°C jusqu'à 40°C ; 20 % jusqu'à 75 % d'humidité relative

Température de stockage admissible : -10°C jusqu'à +60°C

Processus de numérotation : MFV / IWV

Fonction touche R : Flash (100 ms/300 ms/600 ms)

Dimensions de la base (mm): L / B / H = env. 110 x 92 x 29/45

Dimensions du combiné (mm): L / B / H = env. 161 x 48 x 16

Configuration du câble de raccordement téléphonique :

TSV 3/4 selon CTR 37 (configuration européenne)

Bloc d'alimentation : prise européenne

Déclaration de conformité



Cet appareil répond aux exigences des directives de l'union européenne (UE) :

- 1999/5/CE Directive sur les installations de radio et de télécommunication et la reconnaissance réciproque de leur conformité.
- 2005/32/CE Directive « Produits consommateurs d'énergie ».
- Règlement 1275/2008 « Consommation d'électricité en mode veille et en mode arrêt ».
- Règlement 278/2009 « Sources d'alimentation hors charge et leur rendement moyen en mode actif ».

La conformité avec les directives mentionnées ci-dessus est confirmée sur l'appareil par la marque CE. Pour obtenir toute la déclaration de conformité, veuillez utiliser le téléchargement gratuit de notre site Internet www.switel.com.

Remarques d'entretien

Nettoyez les surfaces du boîtier avec un chiffon doux et non pelucheux.

N'utilisez pas de produits d'entretien ou de solvants.

Garantie

Les appareils SWITEL sont fabriqués selon les procédés les plus modernes et sont contrôlés. Des matériels sélectionnés et des technologies de pointe ont pour effet un fonctionnement irréprochable et une longue durée de vie. La garantie ne rentre pas en jeu si l'exploitant du réseau téléphonique ou une installation à postes supplémentaires éventuellement intercalée est responsable du dysfonctionnement de l'appareil. La garantie n'est pas valable pour les piles, piles rechargeables ou packs de piles utilisés dans le produits. La durée de la garantie est de 24 mois, à partir de la date d'achat.

Pendant la durée de la garantie, tous les défauts, dus à des vices de matériel ou de fabrication, seront éliminés gratuitement. Le droit à la garantie expire en cas d'intervention de l'acheteur ou de tiers. Les dommages provenant d'un maniement ou d'une manipulation incorrects, d'une mauvaise mise en place ou d'une mauvaise conservation de l'appareil, d'un raccordement non conforme

ainsi que d'un cas de force majeure ou autres influences extérieures, sont exclus de la garantie.

Nous nous réservons le droit, en cas de réclamations, de réparer ou de remplacer les composants défectueux ou d'échanger l'appareil. Les composants remplacés ou les appareils échangés deviennent notre propriété.

Les demandes de dommages et intérêts sont exclues tant qu'elles ne reposent pas sur l'intention ou une négligence grossière du fabricant.

Si votre appareil devait malgré tout présenter une défectuosité pendant la période de garantie, veuillez vous adresser, muni de la quittance d'achat, exclusivement au magasin où vous avez acheté votre appareil SWITEL. Vous ne pouvez faire valoir vos droits à la garantie selon ces dispositions qu'auprès de votre revendeur exclusivement. Deux ans après l'achat et la remise de nos produits, il n'est plus possible de faire valoir les droits à la garantie.

Index

A

Affichage de la durée de la communication	17
Appareils médicaux	3
Appeler	15

B

Bloc secteur	2
--------------	---

C

Chargeur	5
Conférence	18
Configuration d'origine	36
Consignes de sécurité	2
Contenu de l'emballage	4
Contraste	26

D

Date / heure	6
Date/heure	23
Débranchement du microphone	17
Déclaration de conformité	38
Déclarer/retirer un combiné	29
Désactiver la sonnerie du combiné	19
Désactiver le combiné	19

E

Élimination	3
Etat à la livraison	36

G

Garantie	38
----------	----

I

Icônes	10
--------	----

L

Langue	7, 25
Lieu d'installation	2
Liste d'appels	16

M

Mettre en place les piles rechargeables	6
Mode ÉCO	14
Mode veille	14

N

Navigation dans le menu	14
Nom du combiné	25

P

Panne de courant	2
Piles rechargeables	2
PIN	28
Postes supplémentaires	30
Prendre l'appel	15
Prise d'appel automatique	7
Processus de numérotation	27
Puissance absorbée	4

R

Raccorder la base	.5
Recharger les piles rechargeables	.6
Recherche erronée	.35
Réduction du rayonnement	.14
Remarques d'entretien	.38
Remettre	.27, 28
Répertoire	.16
Répétition des derniers numéros 16, 20	
Réponse autom.	.7
Réponse d'appel automatique	.26
Réveil	.23

S

Sélectionner la base	.26
Services confort	.30
Sonnerie de la base	.27
Sonnerie du combiné	.24

T

Tableau de caractères	.32
Téléphoner en interne	.17
Temps de flash	.28
Terminer la communication	.15
Tonalités d'information	.25
Touches de navigation	.12
Transfert d'une communication externe	.18

U

Utilisation conforme aux prescriptions 2	
Utiliser la liste d'appels	.20

V

Va-et-vient	.18
Verrouillage du clavier	.19
Volume sonore de l'écouteur	.17

1	Indicazioni di sicurezza	.2
2	Mettere in funzione il telefono	.4
3	Elementi di comando	.8
4	Informazioni introduttive	.10
5	Compiere telefonate	.15
6	Funzioni speciali	.19
7	Elenco chiamate/ripetizione di selezione	.20
8	Rubrica telefonica	.21
9	Impostazioni Telefono	.23
10	Registrare/cancellare un'unità portatile	.29
11	Impianti telefonici interni / Servizi aggiuntivi	.30
12	Appendice	.31



Indicazioni di sicurezza

1 Indicazioni di sicurezza

Leggere attentamente le presenti istruzioni per l'uso.

Impiego conforme agli usi previsti

Il presente telefono consente di svolgere telefonate all'interno di una rete telefonica. Qualsiasi altro impiego è considerato come non conforme agli usi previsti. Non sono consentite modifiche o trasformazioni non autorizzate. Non aprire per nessuna ragione l'apparecchio autonomamente, né compiere riparazioni di propria iniziativa.

Luogo di installazione

Evitare l'esposizione a fumo, polvere, vibrazioni, sostanze chimiche, umidità, eccessivo calore o irradiazioni solari dirette.

Non utilizzare l'unità portatile in aree esposte al rischio di deflagrazione.

Alimentatore di rete

 **Attenzione:** Utilizzare solo l'alimentatore a spina fornito in dotazione visto che altri alimentatori di rete potrebbero addirittura danneggiare il telefono. Non ostacolare il libero accesso all'alimentatore a spina con mobili o altri oggetti simili.

Accumulatore ricaricabile

 **Attenzione:** Non gettare batterie ricaricabili nel fuoco. Utilizzare esclusivamente l'accumulatore ricaricabile fornito all'interno della confezione. Osservare la corretta polarità! Pericolo di esplosione durante il caricamento della batteria in caso di errata polarità.

Caduta di tensione

In caso di caduta di tensione non è possibile compiere chiamate con il telefono. Si consiglia di ricorrere in caso di emergenza ad un telefono con filo in grado di funzionare anche senza alimentazione elettrica esterna.

Apparecchiature mediche

 **Attenzione:** Non utilizzare il telefono in prossimità di apparecchiature mediche. Non è possibile escludere il subentro di eventuali interferenze.

Telefoni **DECT**¹ possono causare un fastidioso ronzio in apparecchi acustici.

Smaltimento

Procedere allo smaltimento dell'apparecchio esaurito consegnandolo presso uno dei punti di raccolta istituiti dalla propria società di smaltimento rifiuti comunale (per es. centro di riciclo materiali). Il simbolo riportato qui a lato indica che non è assolutamente consentito smaltire l'apparecchio assieme ai normali rifiuti domestici!



Secondo quanto previsto dalla legge sugli **apparecchi elettrici ed elettronici**, i proprietari di apparecchi esauriti sono per legge tenuti alla consegna di tutti gli apparecchi elettrici ed elettronici presso un centro di rilievo rifiuti in raccolta differenziata.

Consegnare le batterie ricaricabili per lo smaltimento presso rivenditori al dettaglio di batterie o centri di raccolta che mettono a disposizione appositi contenitori.



Smaltire **confezioni ed imballaggi** in base a quanto indicato dalle norme in vigore a livello locale.



¹ DECT: **D**igital **E**nanced **C**ordless **T**elecommunication = Standard per telefoni senza cavo

Mettere in funzione il telefono

2 Mettere in funzione il telefono

Indicazioni di sicurezza

 **Attenzione:** Prima della messa in funzione, leggere attentamente le indicazioni di sicurezza riportate al capitolo 1.

Verificare il contenuto della confezione

La confezione contiene:

Contenuto	Modello DF861	DF862 ¹	DF863 ¹	DF864 ¹
Stazione base				
con alimentatore di rete	1	1	1	1
Stazione di carica con alimentatore	-	1	2	3
Unità portatile	1	2	3	4
Cavo di collegamento telefonico	1	1	1	1
Accumulatore ricaricabile	1	2	3	4
Istruzioni per l'uso	1	1	1	1

¹ Per ulteriori informazioni riguardo la disponibilità di questo set telefonico si prega di visitare il sito www.switel.com.

Potenza assorbita

La potenza assorbita dalla stazione base ammonta a:

- in servizio (stand-by/conversazione): ca. 1,2 W
- durante la carica dell'unità mobile: ca. 2 W.

Il carico nullo de circuito di alimentazione rete è pari a circa 0,15 W.

L'efficienza media è pari a circa il 60 %.

La potenza assorbita dalla stazione di carica ammonta a:

- senza unità mobile: ca. 0,15 W
- durante la carica dell'unità mobile: ca. 1,2 W.

Il carico nullo de circuito di alimentazione rete è pari a circa 0,15 W.

L'efficienza media è pari a circa il 60 %.

Collegare la stazione base

⚠ Attenzione: Montare la stazione base con una distanza minima di 1 m da altri apparecchi elettronici in modo da evitare interferenze reciproche.

Procedere al collegamento della stazione base seguendo quanto raffigurato nella figura. Utilizzare per motivi di sicurezza solo l'alimentatore di rete oltre che il cavo di collegamento telefonico forniti in dotazione.

Preso di collegamento telefonico

Preso elettrica

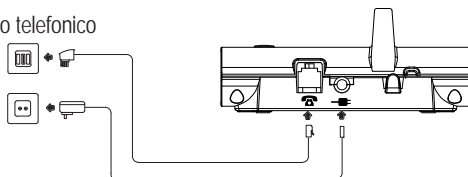

⚠ Attenzione: Utilizzare per la stazione base, solo l'alimentatore fornito in dotazione S002CV0600030 / 6V, 300 mA DC!

Collegare la stazione di carica ²

Procedere al collegamento della stazione di carica secondo quanto indicato nella figura. Per motivi di sicurezza si prega di utilizzare soltanto l'alimentatore di rete fornito in dotazione.

Preso elettrica

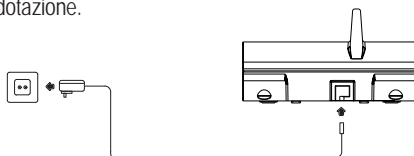

⚠ Attenzione: Utilizzare per la stazione di carica, solo l'alimentatore fornito in dotazione S002CV0600030 / 6 V, 300 mA DC!

² Vale solo per set telefonici con minimo due unità portatili, -> "Verificare il contenuto della confezione".

Mettere in funzione il telefono

Inserire l'accumulatore ricaricabile

Aprire il vano batteria. Introdurre il connettore dell'accumulatore ricaricabile nella presa presente all'interno del vano batteria. Piazzare l'accumulatore ricaricabile nel vano batteria. Chiudere infine il vano accumulatore.

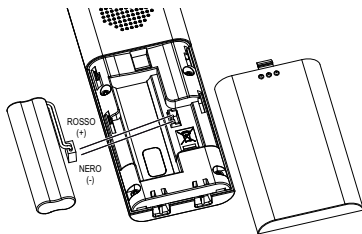

⚠ Attenzione: Utilizzare esclusivamente l'accumulatore ricaricabile fornito all'interno della confezione: 2,4 V, 500 mAh, NiMH! Osservare la corretta polarità! Non utilizzare mai batterie/celle primarie!

Caricare le batterie

👉 Riporre l'unità portatile in sede di prima messa in funzione per minimo 14 ore nella stazione base / stazione di carica.

L'unità portatile si surriscalda durante il processo di carica. Questo è un fenomeno normale e non pericoloso. Evitare di caricare l'unità portatile con dispositivi di carica differenti o estranei. L'avviso di batteria scarica verrà visualizzato sul display. Quando il livello di carica della batteria è sceso al limite, sul display lampeggia il simbolo della batteria (🔋) e viene emesso un allarme acustico (nel caso di allarme acustico abilitato/menu **"Imposta Port./Imposta Toni/ Attenzione"**). Sono ancora a disposizione circa 10 minuti di chiamata.

Impostare ora e data dell'unità portatile

All'accensione l'unità portatile non dispone di un'impostazione oraria corretta (per esempio: per le registrazioni nell'elenco chiamate). Impostate data e ora nel menu **"Ora/Sveglia / Data e ora"**.

Impostare la lingua di display

La lingua di display può essere impostata in 4 diverse lingue. Il telefono è impostato su "Tedesco". Modificare la lingua nel menu "MT einstellen / Sprache".

Accettazione di chiamata automatica / Risposta dir

L'attivazione di questa funzione consente di ricevere automaticamente una chiamata estraendo semplicemente l'unità portatile dalla stazione base. L'accettazione di chiamata automatica è attivata o disattivata nel menu "**Imposta Port./ Risposta Autom.**".



3 Elementi di comando

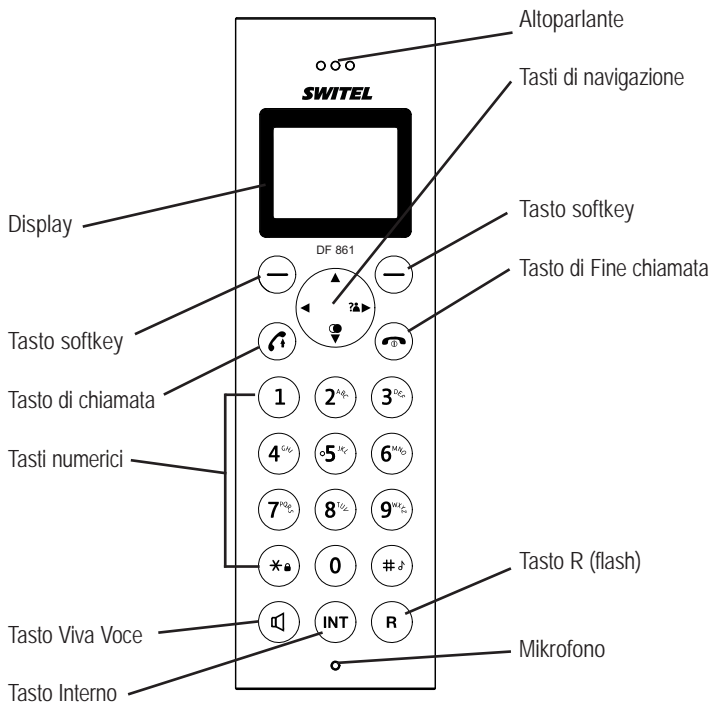

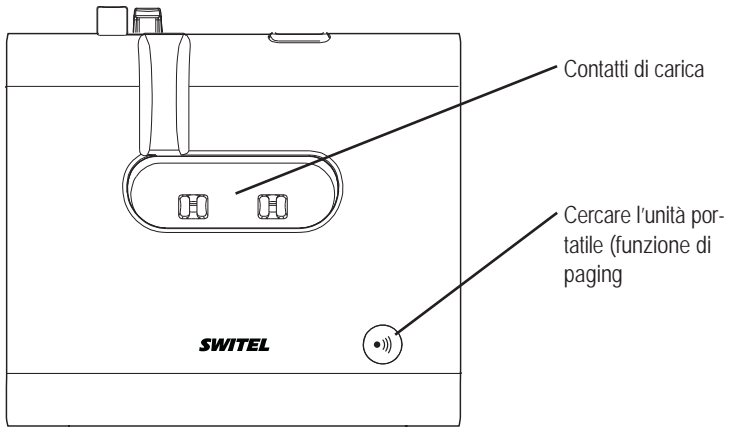











4 Informazioni introduttive

In questo capitolo sono riportate le principali informazioni riguardo l'uso delle presenti istruzioni e del telefono.

Modi di rappresentazione delle istruzioni per l'uso

Rappresentazione	Descrizione
	Premere il tasto raffigurato
	Inserire numeri o lettere
	L'unità portatile squilla
	Stazione base squilla
	Estrarre l'unità portatile dalla stazione base
	Riporre l'unità portatile nella stazione base
Name?	Rappresentazione di testi sul display
	Rappresentazione di simboli sul display

Simboli sul display dell'unità portatile

Simbolo	Descrizione
	Costante: Collegamento con la stazione base Lampeggiante: Il collegamento con la stazione base si interrompe.
	Costante: Indicazione dello stato di carica delle batterie. Segmenti che scorrono quando l'unità portatile è collegata all'unità base: le batterie ricaricabile è in fase di carica.
	Alcuni segmenti non vengono visualizzati: le batterie dovrebbero essere ricaricate.
	Lampeggiante: Caricare le batterie. Costante: Chiamata in corso. Lampeggiante: Chiamata in arrivo.



La funzione vivavoce è attivata.
La segnalazione acustica di chiamata è disinserita.
Costante: Funzione allarme inserita.



Lampeggiante: Allarme.
Il blocco tastiera è attivato.
E' in corso una chiamata interna (solo con più unità portatili registrate su una sola base).
Chiamata interna in arrivo.



Con un messaggio dell'elenco chiamate: Nuova Chiamata
Altri tasti cifra/carattere precedenti o successivi al tasto attualmente selezionato. Per selezionarli premere il tasto freccia.

Nelle seguenti descrizioni del display vengono visualizzate le funzioni disponibili per entrambi i softkey a seconda della modalità.

Menu	Aprire il Menu.
Rubri.	Accesso alla Rubrica.
Selez	Selezionare tra le voci del menu evidenziate.
OK	Confermare una selezione.
Indiet	Ritornare al livello precedente del menu o terminare la funzione.
Canc	Tornare indietro-cancellare le voci inserite (una pressione breve cancella gli ultimi segni, una pressione più lunga cancella l'intera riga).

Tasti di navigazione



Nel menu/negli elenchi (Rubrica, Elenco chiamate, Ripetizione di selezione): sfogliare verso l'alto.
Nel corso di una chiamata: alzare il volume.



Durante la modifica di una voce/durante una selezione: spostare il cursore a sinistra.



In modalità stand-by: aprire l'elenco chiamate
Durante la modifica di una voce/ durante una selezione: spostare il cursore a destra.



In modalità stand-by: aprire l'elenco delle ripetizioni di selezione.
Nel corso di una chiamata: abbassare il volume.
Nel menu/negli elenchi (rubrica, elenco chiamate, ripetizione di selezione): sfogliare verso il basso.

Funzioni speciali di alcuni tasti



Nell'immissione di un numero di telefono: inserire una pausa di selezione tenendo premuto.



In modalità stand-by: accendere/spengere il telefono tenendo premuto il tasto.

Nell'inserimento di un nominativo: scorrere la tabella dei caratteri (Latino/Russo/Greco) tenendo premuto il tasto, vedi le tabelle in appendice.

Nel corso di una comunicazione: per passare temporaneamente alla selezione a toni quando è attivata la selezione ad impulsi.



In modalità stand-by: attivare/disattivare il tono chiamata dell'unità portatile tenendo premuto il tasto.

Nell'inserimento di un nominativo: passare da maiuscolo a minuscolo e viceversa tenendo premuto il tasto.

Modalità di stand-by

In tutte le descrizioni del presente manuale di istruzioni si considera l'unità portatile in modalità di stand-by. Per passare alla modalità di stand-by, premere il tasto  .

Riduzione delle radiazioni (modalità ECO)



Le radiazioni sono considerevolmente ridotte in modalità conversazione rispetto ad un telephono cordless a standard DECT.

Navigazione nel menu

I differenti menu consentono di raggiungere tutte le funzioni del telefono. La struttura completa del menu si trova in appendice.

Per la navigazione nel menu utilizzare le softkeys ed i tasti freccia.

Utilizzando i Softkeys a sinistra **Menu** si accede al menu.

Utilizzare i tasti freccia  e  per navigare all'interno del menu.

Per aprire un sottomenu premere il tasto **Selez.**

Per ritornare al livello del menu precedente premere **Indiet.**

Tornare in modalità stand-by tenendo premuto il tasto di fine chiamata.

5 Compiere telefonate

Ricevere una chiamata

  Il telefono suona.

L'unità portatile **non** si trova inserita nell'unità base:

 /  Premere il tasto di risposta o il vivavoce.

L'unità portatile non si trova inserita nell'unità base e la **Risposta Autom. non** è inserita:

 /  Sollevare l'unità portatile dall'unità base e premere il tasto di risposta o il vivavoce.

L'unità portatile non si trova inserita nell'unità base e la **Risposta Autom.** è inserita:

 E' sufficiente prelevare l'unità portatile dall'unità base; la conversazione sarà automaticamente accettata.

Telefonare

 Immettere un numero di chiamata.

In caso di immissione errata, correggere **Canc.**

 /  Il numero di chiamata viene selezionato.

 E' altresì possibile premere prima il tasto di chiamata e ricevere il segnale di linea libera. Le cifre immesse per la composizione del numero desiderato verranno così selezionate. Con questo tipo di funzione chiamata non è possibile correggere le singole cifre che compongono il numero di chiamata.

Concludere una chiamata

 /  Premere il tasto di fine chiamata o riporre l'unità portatile sull'unità base.

Compiere telefonate

Ripetizione di selezione

 Il telefono memorizza gli ultimi 20 numeri composti. Se il numero è stato inserito nella rubrica del telefono, apparirà il nome memorizzato con quel numero. Per visualizzare il numero corrispondente al nome premere il tasto **Selez.**



Aprire l'elenco di ripetizione di chiamata.



Selezionare la voce.



Il numero di chiamata viene selezionato.

Per chiamare un numero dall'elenco chiamate

 Il vostro telefono memorizza le ultime 30 chiamate nell'elenco chiamate. Se il numero è stato inserito nella rubrica del telefono, apparirà il nome memorizzato con quel numero. Per visualizzare il numero corrispondente al nome premere il tasto **Selez.** La memorizzazione può avvenire solo, se sulla vostra connessione è disponibile "l'identificazione del numero di chiamata (CLIP)" e se il numero di chi telefona non è trattenuto o non è trasmesso per altri motivi.



Aprire l'elenco chiamate.



Selezionare la voce.



Il numero di chiamata viene selezionato.

Effettuare delle chiamate dalla rubrica

 La rubrica può contenere fino a 100 voci. Per immettere una voce vedere la sezione „Rubrica Telefonica“.

Rubri. Aprire la rubrica telefonica.



Selezionare la voce.



Il numero di chiamata viene selezionato.

Visualizzazione della durata di conversazione

Durante lo svolgimento di una chiamata, la durata della telefonata è visualizzata in ore, minuti e secondi.

Impostare il volume del ricevitore



Il volume è regolabile durante lo svolgimento di una chiamata in 5 livelli (dal ricevitore -> volume ricevitore, dal vivavoce -> volume altoparlante).

Le impostazioni sono separate tra di loro e rimangono memorizzate anche una volta terminata la conversazione.

Silenziamento del microfono nell'unità portatile

MicOFF

Durante la conversazione è possibile disattivare il microfono, per fare in modo che il vostro interlocutore non vi possa sentire. Sul display apparirà **Microfono Off**.

Mic ON

Per attivare il microfono premere il tasto ripristina.

Compiere chiamate interne

 Le conversazioni interne, trasferimenti di chiamata e teleconferenze sono possibili solo quando sono registrate più unità portatili. Se non è questo il caso, sul display verrà visualizzato **Non disponibile**.

Effettuare chiamate interne

INT

Premere il softkey **INT**. Se sono registrate due unità portatili, verrà chiamato subito l'altra unità portatile. Se sono registrate più unità portatili, vengono visualizzati i relativi numeri interni (per esempio 2 3 4). Selezionare con i tasti freccia  /  l'unità portatile desiderata e confermare con **Selez.** Selezionare "9" per chiamare contemporaneamente tutti i telefoni collegati.

Compiere telefonate

Trasferire chiamate esterne

INT

Nel corso di una chiamata esterna. . .

Premere il tasto **INT**.

Selezionare con i tasti freccia  /  l'unità portatile desiderata e confermare con **Selez.**

La chiamata esterna verrà trattenuta.

Se l'unità portatile chiamata è accesa, verrà eventualmente annunciata la comunicazione.



Premere il tasto di fine chiamata. La chiamata è stata trasmessa.

Conversazione intermedia

INT

Nel corso di una chiamata esterna. . .

Premere il tasto **INT**.

Selezionare con i tasti freccia  /  l'unità portatile desiderata e confermare con **Selez.**

La chiamata esterna verrà trattenuta.

INT

Passare da un interlocutore all'altro con il tasto **INT**.

Teleconferenza

Nel corso di una conversazione intermedia (vedi sopra) . . .

Per parlare con l'altro utente interno:

INT

Tenere premuto il tasto **INT** finché non appare **Conferenza** sul display.

 Se uno dei partecipanti alla teleconferenza riattacca, gli altri partecipanti rimangono connessi fra di loro.

6 Funzioni speciali

Blocco tastiera

 Il blocco tastiera impedisce la digitazione involontaria dei tasti. Le chiamate in arrivo possono essere ricevute come di consueto.



Tenere premuto il tasto asterisco fino a quando appare sul display il simbolo del blocco tastiera.



Per sbloccare la tastiera tenere premuto nuovamente il tasto asterisco fino a quando il simbolo non scompare di nuovo.

Disattivare il tono chiamata sull'unità portatile

 E' possibile disattivare il tono chiamata anche sul menu „Imposta portat / Imposta suoneria / Volume suoneria“.



Tenere premuto il tasto cancelletto fino a quando il simbolo di disattivazione tono chiamata  non appare sul display.



Per riattivare il tono chiamata tenere premuto nuovamente il tasto cancelletto fino a quando non riappare il simbolo.

Spegnimento unità portatile

 Per risparmiare la batteria spegnere l'unità portatile.



Tenere premuto il tasto di fine chiamata. Dopo alcuni secondi l'unità portatile si spegnerà. L'illuminazione del display si spegnerà.



Per riaccendere l'unità portatile tenere premuto il tasto di fine chiamata fino a quando non si avverte un segnale acustico e fino a quando il display non si illuminerà di nuovo.

7 Elenco chiamate/ripetizione di selezione

Modificare l'elenco chiamate



Accedere all'elenco chiamate.



Selezionare una voce e premere il softkey **Selez** per visualizzare data e ora della chiamata.

Menu

Premere il softkey **Menu**.



Selezionare una delle seguenti opzioni e confermare con **Selez**:
Agg a Rubrica Il numero di chiamata verrà memorizzato nella rubrica. Se è inserito un nome, confermare o modificare il numero di telefono ed associare una suoneria per questa voce della rubrica.

Cancella

La voce verrà eliminata a seguito di un'ulteriore richiesta di conferma.

Cancella tutto

L'intera rubrica verrà eliminata a seguito di un'ulteriore richiesta di conferma.

 E' possibile accedere all'elenco chiamate anche dal menu:

(Menu  /  **Liste chiamate / Ricevute / Selez**).

Modificare ripetizione di selezione



Accedere alla ripetizione di selezione.



Selezionare una voce e premere il softkey **Selez**.

Menu

Premere il softkey **Menu**.



Selezionare una delle seguenti opzioni e confermare con **Selez**:
Agg a Rubrica Il numero di chiamata verrà memorizzato nella rubrica. Se è inserito un nome, confermare o modificare il numero di telefono ed associare una suoneria per questa voce della rubrica.

Cancella

La voce verrà eliminata a seguito di un'ulteriore richiesta di conferma.

Cancella tutto

L'intera rubrica verrà eliminata a seguito di un'ulteriore richiesta di conferma.

8 Rubrica telefonica

 Nella rubrica è possibile memorizzare fino a 100 numeri di telefono e relativi nomi. E' possibile associare ad ogni voce una suoneria, con la quale verrà segnalata la chiamata. Immettere sempre il numero di telefono con il relativo prefisso; questo permetterà una corretta visualizzazione del corrispondente chiamante, per il quale è stata inserita una voce nella rubrica e per il quale sulla vostra connessione è disponibile la trasmissione del numero.

Aggiungere una nuova voce alla rubrica

Menu

Premere il softkey **Menu**.



Selezionare **Rubrica** e confermare con **Selez.**



Selezionare **Aggiungi** e confermare con **Selez.**



Immettere il nome (al max. 12 caratteri).

Le cifre si immettono con i tasti carattere. Premendo più volte il tasto relativo è possibile inserire caratteri e cifre.

Passare da maiuscolo a minuscolo e viceversa tenendo premuto il tasto #.

Dopo una breve attesa il cursore procede automaticamente.

Terminare l'immissione del nome con .



Inserire il numero di telefono (max. 24 cifre). Se il telefono è collegato ad un impianto telefonico interno, è necessario selezionare un numero di accesso alla rete esterna. Se occorre una pausa di selezione, premere il tasto **0** per circa 2 secondi dopo aver inserito il numero di accesso alla rete esterna; sul display apparirà la lettera **P**.

Terminare l'immissione del nome con .



Selezionare una suoneria per la nuova voce della rubrica.

OK

Confermare con **OK**.



Modificare le voci della rubrica

- Menu** Premere il softkey **Menu**.
-  /  Selezionare **Rubrica** e confermare con **Selez.**
-  /  Selezionare una delle seguenti opzioni e confermare con **Selez.**
- Leggi** Per visualizzare tutte le voci della rubrica. Sfogliare l'elenco fino alla voce desiderata. Premere **Selez** per visualizzare Nome, Numero di Telefono e Suoneria. Modificare o eliminare la voce con **Menu**.
- Aggiungi** Per aggiungere una nuova voce alla rubrica.
Modifica Tutte le voci della rubrica vengono visualizzate. Sfogliare l'elenco fino alla voce desiderata. Per modificare una voce premere **Selez**.
Eliminare caratteri e cifre con **Canc**, inserire con i tasti cifra dei nuovi caratteri e nuove cifre. Per ulteriori dettagli consultare "Immettere nuova voce".
- Cancella** Tutte le voci della rubrica vengono visualizzate. Sfogliare l'elenco fino alla voce desiderata. Premendo **Selez** la voce verrà eliminata..
- Cancella tutto** Premendo **Selez** tutta la rubrica verrà eliminata dopo un'ulteriore richiesta di conferma.
- Stato Rubrica** Verrà visualizzata la situazione attuale della rubrica (per esempio **07/100 Occup**: sono disponibili 7 voci su 100 della rubrica).

9 Impostazioni Telefono

Data/Ora

Menu



Premere il softkey **Menu**.

Selezionare **Ora/Sveglia** e premere **Selez.**

Selezionare **Data e ora** e premere **Selez.**

Selezionare una delle seguenti opzioni e confermare con **Selez.**

Formato data

Per impostare il formato data:

(DD-MM-YYYY oppure MM-DD-YYYY).

Formato Ora

Per impostare il formato ora: (24 ore oppure 12 ore).

Imposta Data

Immettere la data con i tasti cifra.

Imposta Ora

Immettere l'ora con i tasti cifra. Per immettere l'ora nel formato 12 ore, passate da „AM“ a „PM“ con i tasto asterisco.

 In caso di interruzione dell'alimentazione elettrica l'impostazione verrà persa, se contemporaneamente l'unità portatile è disattivata o le batterie sono scariche.

Sveglia

Menu



Premere il softkey **Menu**.

Selezionare **Ora/Sveglia** e premere **Selez.**

Selezionare **Sveglia** e premere **Selez.**

Selezionare **Sveglia Attiva** e premere **Selez.**

Inserire l'ora della sveglia con i tasti cifra e premere **Ok**.

Selezionare **Snooze On** o **Snooze Off** e premere **Selez.**

Se „Snooze“ è inserito, significa che l'allarme della sveglia verrà ripetuto dopo 2 minuti, fino a quando la funzione verrà disattivata tenendo premuto il tasto di fine chiamata.

Se „Snooze“ non è inserito, l'allarme della sveglia verrà emesso solo una volta all'ora impostata. Per arrestare l'allarme della sveglia premere un tasto qualsiasi.

Impostazioni Telefono



Selezionare **Melodia Sveglia** e premere **Selez.**

Selezionare una suoneria e premere **Selez.**

Impostare l'audio dell'unità portatile

Menu

Premere il softkey **Menu**.



Selezionare **Imposta Port.** e premere **Selez.**



Selezionare **Imposta Audio** e premere **Selez.**



Selezionare una delle seguenti opzioni e confermare con **Selez:**

Volume altoparl. Selezionare il volume di riproduzione vivavoce.

Volume auricol. Selezionare il volume per l'auricolare.

 E' possibile regolare queste impostazioni anche nel corso di una conversazione semplicemente tramite i tasti freccia (vedi „Compiere telefonate / Impostare il volume del ricevitore “)

Impostare il tono di chiamata dell'unità mobile

Menu

Premere il softkey **Menu**.



Selezionare **Imposta Port.** e premere **Selez.**



Selezionare **Imposta Suoneria** e premere **Selez.**



Selezionare una delle seguenti opzioni e confermare con **Selez:**

Suonerie Int. Selezionare una suoneria per la segnalazione di una chiamata interna.

Suonerie Est. Selezionare una suoneria per la segnalazione di una chiamata esterna.

Volume Suoneria Selezionare il volume per il tono chiamata. Se viene selezionato „Volume Off“ apparirà sul display il simbolo relativo.

Impostazione toni di avviso

Menu



Premere il softkey **Menu**.



Selezionare **Imposta Port.** e premere **Selez.**



Selezionare **Imposta TONI** e premere **Selez.**

Selezionare una delle seguenti opzioni e confermare con **Selez.**:

Tono Tasti

Attivare o disattivare il tono dei tasti.

Attenzione

Attivare o disattivare il tono di avviso che segnala quando la batteria deve essere ricaricata.

Fuori portata

Attivare o disattivare il tono che segnala quando l'unità portatile si trova fuori dalla copertura del segnale dell'unità base.

Impostazione lingua del display

Menu



Premere il softkey **Menu**.



Selezionare **Imposta Port.** e premere **Selez.**



Selezionare **Lingua** e premere **Selez.**

Selezionare una lingua e confermare con **Selez.**

Impostare nome dell'unità portatile

Menu



Premere il softkey **Menu**.



Selezionare **Imposta Port.** e premere **Selez.**

Selezionare **Nome Portatile** e premere **Selez.**



Eliminare il vecchio nome con **Canc**, inserire il nuovo nome con i tasti cifra e premere **Ok**.

Impostazioni Telefono

Regolare il contrasto

Menu



Premere il softkey **Menu**.

Selezionare **Imposta Port.** e premere **Selez.**

Selezionare **Contrasto** e premere **Selez.**

Selezionare il contrasto desiderato e premere **Selez.**

Impostazione Risposta automatica

Menu



Premere il softkey **Menu**.

Selezionare **Imposta Port.** e premere **Selez.**

Selezionare **Risposta Autom.** e premere **Selez.**

Selezionare se la risposta automatica deve essere attivata o disattivata e premere **Selez.**

Se la risposta automatica è attivata, la chiamata verrà subito accettata nel momento in cui l'unità portatile verrà estratta dall'unità base.

Selezionare l'unità base

Menu



Premere il softkey **Menu**.

Selezionare **Imposta Port.** e premere **Selez.**

Selezionare **Selezione Base** e premere **Selez.**

Viene visualizzato un elenco di unità base alle quali l'unità portatile è stata registrata. L'unità base attualmente attiva è demarcata da un „*“. Selezionare un'unità base e premere **Selez.**

Vengono visualizzate solo le unità base a cui l'unità portatile è già stata

Reimpostare l'unità portatile come da impostazioni predefinite

Menu



Premere il softkey **Menu**.



Selezionare **Imposta Port.** e premere **Selez.**



Selezionare **Reset Portatile** e premere **Selez.**

Inserire il codice PIN attuale e premere **Ok**.

Confermare anche la successiva richiesta di conferma con **Ok**.

 Le registrazioni nella rubrica telefonica non vengono cancellati.

Impostazione Suoneria per l'unità base

Menu

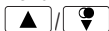

Premere il softkey **Menu**.



Selezionare **Imposta Base** e premere **Selez.**



Selezionare **Imposta Suoneria** e premere **Selez.**

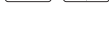

Selezionare una delle seguenti opzioni e confermare con **Selez.**

Suonerie

Selezionare una suoneria per l'avviso di una chiamata.

Volume suoneria

Selezionare il volume o spegnere il tono di avviso.

Impostazione modalità di selezione

Menu

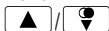

Premere il softkey **Menu**.



Selezionare **Imposta Base** e premere **Selez.**



Selezionare **Modo Composiz.** e premere **Selez.**

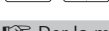

Selezionare **Toni** o **Decadica** e confermare con **Selez.**

 Per la maggior parte degli impianti telefonici, l'impostazione giusta è **Toni**.

Impostazione tempo flash

Menu



Premere il softkey **Menu**.



Selezionare **Imposta Base** e premere **Selez.**



Selezionare **Tempo flash** e premere **Selez.**

Selezionare **Breve** (100 ms), **Medio** (300 ms) oppure **Lungo** (600 ms) e confermare con **Selez.**

Modificare PIN

Menu



Premere il softkey **Menu**.



Selezionare **Imposta Base** e premere **Selez.**

Selezionare **Cambia PIN** e premere **Selez.**



Inserire il codice PIN attuale

(nella configurazione predefinita 0 0 0 0) e premere **Ok**.



Inserire un nuovo codice PIN e premere **Ok**.



Inserire un nuovo codice PIN ancora una volta e premere **Ok**.

Il codice PIN a quattro cifre protegge alcune impostazioni da un accesso non autorizzato. Nel caso non si dovesse ricordare il codice PIN, rivolgersi al nostro Servizio di Assistenza.

Reimpostare l'unità base come da impostazioni predefinite

Menu



Premere il softkey **Menu**.



Selezionare **Imposta Base** e premere **Selez.**

Selezionare **Reset imp predef** e premere **Selez.**



Inserire il codice PIN attuale e premere **Ok**.

Confermare anche la successiva richiesta di conferma con **Ok**.

Le voci che si trovano nella rubrica non verranno eliminate. L'unità portatile registrata rimane registrata.

10 Registrare/cancellare un'unità portatile

Su una stazione base possono essere registrate fino a 5 unità portatili. Le unità portatili fornite con il vostro telefono sono già registrate con l'unità base. Per registrare un'unità mobile „estranea“ si prega di consultare il manuale di istruzioni.

Registrare un'altra unità mobile dello stesso tipo

Menu



Premere il softkey **Menu**.

Selezionare **Affiliazione** e premere **Selez.**

Selezionare una stazione base e premere Selez. Le stazioni base a cui il portatile è già collegato sono rappresentate in vettoriale. La base in uso è contrassegnata con un *.



Inserire l'attuale codice PIN dell'unità di base sulla quale deve essere registrata l'unità portatile e premere **Ok**.



Tenere premuto il tasto Paging nell'unità base fino a quando non viene emesso un tono che indica che la registrazione è avvenuta (ca. 5 sec.).

Poco dopo si illumina costantemente sul display il simbolo dell'antenna e l'unità portatile è così registrata.

Cancellare un'unità portatile

Menu



Premere il softkey **Menu**.

Selezionare **Imposta Base** e premere **Selez.**

Selezionare **Cancella Port.** e premere **Selez.**

Inserire il codice PIN attuale e premere **Ok**.

Selezionare una delle unità portatili registrate e premere **Selez.**



L'unità portatile in uso non può essere cancellata.

11 Impianti telefonici interni / Servizi aggiuntivi

Impianti telefonici interni

Avendo collegato il telefono ad un impianto telefonico interno, il tasto R consente di accedere a tutte le altre funzioni disponibili come per es. trasferimento di chiamata e funzione di richiamata automatica. Si prega di consultare le istruzioni per l'uso del proprio impianto telefonico interno per individuare il tempo flash da impostare al fine di poter usufruire di queste funzioni. Il rivenditore autorizzato è in grado di indicare se il telefono acquistato funzionerà senza alcun problema nel proprio impianto telefonico interno.

Si consiglia di inserire le voci della rubrica con l'eventuale numero di accesso alla rete esterna e la pausa di selezione necessaria (premere a lungo "0").

Servizi aggiuntivi

Il telefono supporta servizi aggiuntivi messi a disposizione dal proprio gestore di rete telefonica come per es. le funzioni di chiamata in attesa, avviso di chiamata e chiamata a conferenza. Il tasto R consente di accedere a questi servizi aggiuntivi. Si prega di consultare il proprio gestore di rete telefonica per ottenere informazioni sul tempo flash necessario all'utilizzo dei servizi aggiuntivi. Rivolgersi al proprio gestore di rete telefonica per ottenere l'abilitazione ai servizi aggiuntivi.

12 Appendice

Struttura di menu



Tabelle caratteri

Caratteri latini/ maiuscoli

0	SP	0	-	+	=	_	()	"	'	[]	{	}	<	>	/	\	^	~	
1	1	.	,	:	;	!	ı	?	ı	*	#	&	%	\$	€	£	@	¤	§		
2	A	B	C	2	À	Á	Â	Ã	Ä	Å	Ą	Æ	Ç	Ć	Č						
3	D	E	F	3	Ď	È	É	Ê	Ë	Ě	Ĕ	Ė									
4	G	H	I	4	Ğ	Ì	Í	Î	Ï	Ī	ı	Ĳ									
5	J	K	L	5	Ł	Ł	Ł														
6	M	N	O	6	Ñ	Ń	Ń	Ò	Ó	Ô	Õ	Ö	Ï	Ø							
7	P	Q	R	7	Ŕ	Ŗ	Ś	Ş	Š	ß											
8	T	U	V	8	Ť	Ù	Ú	Û	Ü	Ū	Ŭ	Ů									
9	W	X	Y	Z	9	Ŵ	Ŷ	Ÿ	Ź	Ż	Ž										

Caratteri latini/ minuscoli

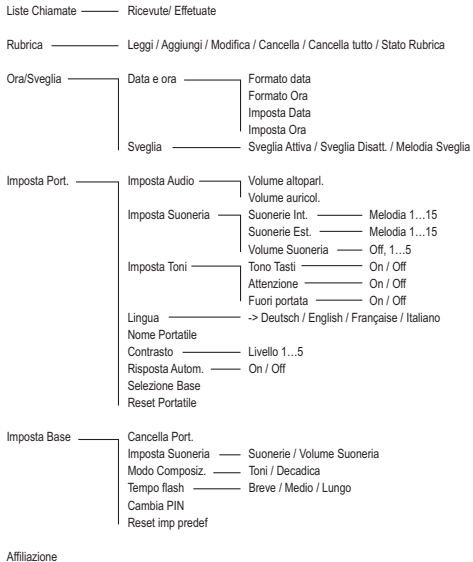
0	SP	0	-	+	=	_	()	"	'	[]	{	}	<	>	/	\	^	~	
1	1	.	,	:	;	!	ı	?	ı	*	#	&	%	\$	€	£	@	¤	§		
2	a	b	c	2	à	á	â	ã	ä	å	ą	æ	ç	ć	č						
3	d	e	f	3	ď	è	é	ê	ë	ě	ĕ	ė									
4	g	h	i	4	ğ	ì	í	î	ï	ī	ı	ĳ									
5	j	k	l	5	ł	ł	ł														
6	m	n	o	6	ñ	ń	ń	ò	ó	ô	õ	ö	ï	ø							
7	p	q	r	7	ŕ	ŗ	ś	ş	š	ß											
8	t	u	v	8	ť	ù	ú	û	ü	ū	ŭ	ů									
9	w	x	y	z	9	ŵ	ŷ	ÿ	ź	ż	ž										

Caratteri russi / maiuscoli

0	SP	0	-	+	=	_	()	"	'	[]	{	}	<	>	/	\	^	~	
1	1	.	,	:	;	!	і	?	¿	*	#	&	%	\$	€	£	@	¤	§		
2	А	Б	В	Г	2																
3	Д	Е	Ж	З	3																
4	И	Й	К	Л	4																
5	М	Н	О	П	5																
6	Р	С	Т	У	6																
7	Ф	Х	Ц	Ч	7																
8	Ш	Щ	Ъ	Ы	8																
9	Ь	Э	Ю	Я	9																

Caratteri russi / minuscoli

0	SP	0	-	+	=	_	()	"	'	[]	{	}	<	>	/	\	^	~	
1	1	.	,	:	;	!	і	?	¿	*	#	&	%	\$	€	£	@	¤	§		
2	а	б	в	г	2																
3	д	е	ж	з	3																
4	и	й	к	л	4																
5	м	н	о	п	5																
6	р	с	т	у	6																
7	ф	х	ц	ч	7																
8	ш	щ	ъ	ы	8																
9	ь	э	ю	я	9																

Appendice

Caratteri greci / maiuscoli

0	SP	0	-	+	=	_	()	"	'	[]	{	}	<	>	/	\	^	~	
1	1	.	,	:	:	!	!	?	¿	*	#	&	%	\$	@	£	@	¤	§		
2	A	B	Γ	2																	
3	Δ	E	Z	3																	
4	H	Θ	I	4																	
5	K	Λ	M	5																	
6	N	Ξ	O	6																	
7	Π	P	Σ	7																	
8	T	Υ	Φ	8																	
9	X	Ψ	Ω	9																	

Caratteri greci / minuscoli

0	SP	0	-	+	=	_	()	"	'	[]	{	}	<	>	/	\	^	~	
1	1	.	,	:	:	!	!	?	¿	*	#	&	%	\$	@	£	@	¤	§		
2	α	β	γ	2																	
3	δ	ε	ζ	3																	
4	η	θ	ι	4																	
5	κ	λ	μ	5																	
6	ν	ξ	ο	6																	
7	π	ρ	ς	σ	7																
8	τ	υ	φ	8																	
9	χ	ψ	ω	9																	

Localizzazione guasti

In presenza di problemi con il telefono, seguire le indicazioni riportate qui di seguito. In caso di problemi tecnici è possibile rivolgersi alla nostra hotline di assistenza tecnica chiamando al numero 0900 00 1675 valido per la Svizzera (spese da rete Swisscom alla data di stampa: CHF 2.60 / min). In caso di reclami entro il periodo di garanzia, rivolgersi al rivenditore autorizzato. Il periodo di garanzia ricopre 2 anni.

- Dopo la selezione del tasto di risposta non è udibile alcun segnale acustico, la linea non è occupata.
 - Controllare la spina della connessione telefonica sull'unità base e sulla presa del telefono.
 - Controllare la spina elettrica sull'unità di base e sul 230 V.
 - La linea è occupata da un'altra unità portatile. Attendere fino a quando non è terminata la comunicazione.
- Sul display è visualizzato „RICERCA“.
 - Controllare la spina elettrica sull'unità di base e sul 230 V.
 - Ridurre la portata.
 - Cancellare l'unità portatile.
- L'unità base non suona.
 - Tono di chiamata disattivato -> attivarlo.
- Nessuna visualizzazione sul display.
 - Unità portatile spenta -> accenderla.
 - Batterie scariche -> caricare le batterie.



Impostazioni predefinite/Configurazioni predefinite

Elenco chiamate	Vuoto
Rubrica telefonica	Vuoto
Sveglia	Disattivato
Suoneria pt	Interno: Melodia 2 Esterno: Melodia 1 Volume: 3
Suoneria bs	Melodia 1 Volume: 3
Imposta toni	Toni tasti: Attivato Toni batt: Attivato Fuoriportata: Attivato
Lingua	Tedesco
Nome portatile	DF 86x
Risposta aut.	Attivato
Data e ora	Formato data: DD-MM-YYYY Formato ora: 24 ora
Proc selezione	Toni
Tempo flash	Breve (100 ms)
PIN	0 0 0 0

Dati Tecnici

Standard: DECT / GAP

Numero di canali: 120 canali duplex

Frequenza: 1880 MHz - 1900 MHz

Procedura duplex: a divisione di tempo, 10 ms lunghezza trama

Distanza canali: 1728 kHz

Bit rate: 1152 kBit / s

Modulazione: GFSK

Codifica Voce: 32 kBit / s

Potenza di trasmissione: 10 mW (potenza media per canale)

Copertura: fino a 300 metri all'aperto, fino a 50 metri all'interno di un edificio

Alimentazione stazione base:

100-240 V AC (Adattatore S002CV0600030), 6 V DC / 300 mA

Alimentazione Unità di carica:

100-240 V AC (Adattatore S002CV0600030), 6 V DC / 300 mA

Autonomia dell'unità portatile: in stand-by/in conversazione

500 mAh = ca. 100 h / ca. 10 h

Tempo di carica della batteria: ca. 14 Ore

Requisiti ambientali ammessi per il funzionamento dell'unità portatile:

5°C - 40°C ; 20 % - 75 % umidità relativa dell'aria

Requisiti ambientali ammessi per il funzionamento dell'unità base:

5°C - 40°C ; 20 % - 75 % umidità relativa dell'aria

Temperatura di conservazione: -10°C - +60°C

Selezione impostabile: MFV / IWV

Funzione Flash: Flash (100 ms/300 ms/600 ms)

Dimensioni stazione di base (mm): Lungh./Largh./Alt. = ca. 110 x 92 x 29/45

Dimensioni unità portatile (mm): Lungh./Largh./Alt. = ca. 161 x 48 x 16

Corrispondenza cavo di connessione del telefono:

TSV per Pin 3 e 4 conforme CTR 37 (conformità europea)

Trasformatore: presa europea

Dichiarazione di conformità



Questo apparecchio risponde a quanto disposto dalla Direttiva UE:

- 1999/5/CE Direttiva concernente le apparecchiature radio, le apparecchiature terminali di telecomunicazioni e il reciproco riconoscimento della loro conformità.
- 2005/32/CE Direttiva "Prodotti che consumano energia".
- Regolamento 1275/2008 "Consumo di energia elettrica nei modi stand-by e spento".
- Regolamento 278/2009 "I componenti di rete in caso di peso nullo, nonché la loro efficienza media in funzionamento".

La conformità con la direttiva di cui sopra viene confermata dal marchio CE applicato sull'apparecchio.

Per la dichiarazione di conformità completa si prega di voler usufruire del servizio gratuito di download dal nostro sito Internet www.switel.com.

Consigli per la cura

Pulire le superfici degli apparecchi con un panno morbido e antipilling.
Non utilizzare mai detersivi o solventi.

Garanzia

Gli apparecchi SWITEL sono costruiti e collaudati in osservanza dei processi di produzione più moderni. L'impiego di materiali selezionati e tecnologie altamente sviluppate sono garanti di una perfetta funzionalità e lunga durata in vita. La garanzia non viene considerata esecutiva qualora la causa del malfunzionamento dell'apparecchio è dovuta al gestore della rete telefonica oppure se questa è da attribuirsi ad un impianto telefonico interno interposto. La garanzia non si estende a batterie, accumulatori o batterie ricaricabili utilizzati all'interno degli apparecchi. Il periodo di garanzia ricopre 24 mesi a partire dalla data di acquisto.

Entro il periodo di garanzia si procederà all'eliminazione gratuita di tutti i guasti dovuti a difetti di materiale o produzione. Il diritto di garanzia cessa in caso di

interventi da parte dell'acquirente o di terzi. Danni derivanti da un impiego o esercizio non conforme agli usi previsti, a naturale usura, a errato montaggio o errata conservazione, a collegamento o installazione impropri, dovuti a forza maggiore o ad altri influssi esterni non sono coperti da garanzia. In qualità di produttore ci riserviamo il diritto, in caso di reclami, di riparare o sostituire le parti difettose o di rimpiazzare l'apparecchio.

Parti o apparecchi sostituiti passano di nostra proprietà. Sono esclusi diritti di risarcimento per danni qualora non siano dovuti a intenzione o colpa grave del costruttore.

Nel caso in cui il presente apparecchio dovesse ciò nonostante presentare un difetto durante il periodo di garanzia, si prega di rivolgersi esclusivamente al negozio di rivendita dell'apparecchio SWITEL assieme al relativo scontrino di acquisto. In base alle presenti disposizioni, tutti i diritti di garanzia dovranno essere fatti valere esclusivamente nei confronti del rivenditore autorizzato.

Decorso il termine di due anni dalla data di acquisto e consegna dei nostri prodotti non sarà più possibile fare valere alcun diritto di garanzia.

Indice alfabetico

A

Accettazione di chiamata automatica	.7
Accumulatore ricaricabile	.2
Alimentatore di rete	.2
Apparecchiature mediche	.3
Audio dell'unità portatile	.24

B

Blocco tastiera	.19
-----------------	-----

C

Caduta di tensione	.2
Caricare le batterie	.6
Chiamate interne	.17
Collegare la stazione base	.5
Configurazioni predefinite	.36
Consigli per la cura	.38
Contenuto della confezione	.4
Contrasto	.26
Conversazione intermedia	.18

D

Data	.23
Data e ora	.6
Dati Tecnici	.37
Disattivare il tono chiamata sull'unità portatile	.19
Durata di conversazione	.17

E

Elenco chiamate	.16, 20
-----------------	---------

F

Funzioni speciali	.13
-------------------	-----

G

Garanzia	.38
----------	-----

I

Impiego conforme agli usi previsti	.2
Impostare la lingua di display	.7
Impostazioni predefinite	.36
Indicazioni di sicurezza	.2
Inserire l'accumulatore ricaricabile	.6

L

Lingua	.25
Localizzazione guasti	.35
Luogo di installazione	.2

M

Modalità di selezione	.27
Modalità di stand-by	.14
Modalità ECO	.14

N

Navigazione nel menu	.14
Nome dell'unità portatile	.25

O

Ora23

P

PIN28

R

Registrazione/cancellare un'unità
portatile29

Reimpostare27, 28

Ricevere una chiamata15

Riduzione delle radiazioni14

Ripetizione di selezione16, 20

Risposta automatica26

Risposta dir7

Rubrica Telefonica16, 21

S

Selezionare l'unità base26

Servizi aggiuntivi30

Silenziamento del microfono17

Simboli sul display10

Smaltimento3

Spegnimento unità portatile19

Stazione di carica5

Struttura di menu31

Suoneria27

Sveglia23

T

Tabelle caratteri32

Tasti di navigazione12

Teleconferenza18

Telefonare15

Telefonici interni30

Tempo flash28

Toni di avviso25

Tono di chiamata24

Trasferire chiamate esterne18

V

Volume del ricevitore17



1	Safety Information	.2
2	Preparing the Telephone	.4
3	Operating Elements	.8
4	Preliminary Information	.10
5	Telephoning	.15
6	Other features	.19
7	Call list / Redial	.20
8	Phone book	.21
9	Setting the telephone	.23
10	Registering/de-registering handsets	.29
11	PBX / Supplementary Services	.30
12	Appendix	.31

Safety Information

1 Safety Information

Please read this operating instruction manual thoroughly.

Intended use

The telephone is suitable for telephoning within a public telephone network system. Any other use is considered unintended use. Unauthorised modification or reconstruction is not permitted. Under no circumstances open the device or complete any repair work yourself.

Installation location

Prevent excessive exposure to smoke, dust, vibration, chemicals, moisture, heat and direct sunlight.

Do not use the handset in potentially explosive areas.

Power adapter plug

 **Attention:** Only use the power adapter plug supplied because other power supplies could damage the telephone. Ensure access to the power adapter plug is not obstructed by furniture or such.

Rechargeable batteries

 **Attention:** Never throw batteries into a fire. Only use the battery supplied with the unit. Pay attention to the correct polarity. Incorrect polarity of the battery represents a risk of explosion during charging.

Power failure

The telephone cannot be used to make calls in the event of a power failure. Always keep a cord connected telephone which operates without an external power supply available in case of emergency situations.

Medical equipment

 **Attention:** Never use the telephone in the vicinity of medical equipment. Effects on such equipment cannot be fully ruled out.

DECT¹ telephones can cause an unpleasant humming sound in hearing aids.

Disposal

In order to dispose of your device, take it to a collection point provided by your local public waste authorities (e.g. recycling centre). The adjacent symbol indicates that the device must not be disposed of in normal domestic waste!

According to laws on the disposal of **electronic and electrical devices**, owners are obliged to dispose of old electronic and electrical devices in a separate waste container.

Batteries must be disposed of at the point of sale or at the appropriate collection points provided by the public waste authorities.

Packaging materials must be disposed of according to local regulations.



¹ DECT: **D**igital **E**nhanced **C**ordless **T**elecommunication = Standard for cordless telephones.

Preparing the Telephone

2 Preparing the Telephone

Safety information

 **Attention:** It is essential to read the Safety Information in Chapter 1 before starting up.

Checking the package contents

The package contains:

Content	DF 86x model			
	861	862 ¹	863 ¹	864 ¹
Base station / power adapter plug	1	1	1	1
Charging station with power adapter plug	-	1	2	3
Handset	1	2	3	4
Telephone connection cable	1	1	1	1
Rechargeable battery pack	1	2	3	4
Operating instructions	1	1	1	1

¹ Visit www.switel.com to find out whether this telephone is available.

Electrical consumption

The **electrical consumption of the base** is:

- in operation mode (idle/call): approx. 1.2 W
- during charging of the handset: approx. 2 W.

The adaptor input power without load is approx. 0.15 W. The average efficiency is approx. 60 %.

The **electrical consumption of the charger** is:

- without handset charging: approx. 0.15 W
- during charging of the handset: approx. 1.2 W.

The adaptor input power without load is approx. 0.15 W. The average efficiency is approx. 60 %.

Connecting the base station

⚠ Attention: Position the base station at least 1 m away from other electronic devices, otherwise there is a risk of mutual disturbance.

Connect the base station as illustrated in the diagram. For reasons of safety, only use the power adapter plug and telephone connection line supplied.

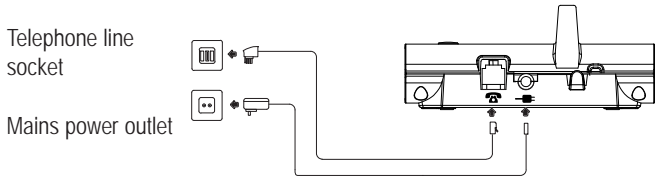

⚠ Attention: Use only the power adapter plug S002CV0600030 / 6V, 300 mA DC supplied with the base station!

Connecting the charging station²

Connect the charging station as illustrated in the diagram.

For safety reasons, only use the power adapter plug supplied.

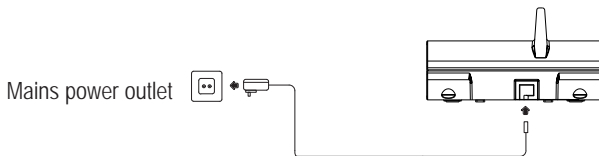

⚠ Attention: Use only the power adapter plug S002CV0600030 / 6 V, 300 mA DC supplied with the charging station!

² Only applies to telephone sets with at least two handsets, see "Checking the package content".

Preparing the Telephone

Inserting the batteries

Open the battery compartment cover. Connect the plug leading from the battery pack to the corresponding socket in the battery compartment. Insert the battery pack in the battery compartment. Close the battery compartment cover.

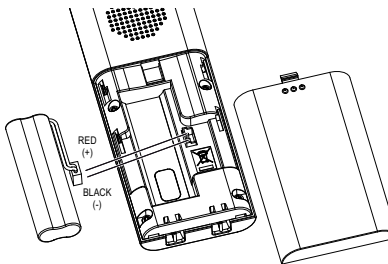

⚠ Attention: Use only the supplied rechargeable battery pack 2.4 V, 500 mAh, NiMH! Observe the correct polarity!

Charging the batteries

👉 Before the handset is used for the first time, insert it in the base station / charging station for at least 14 hours.

The handset warms up during the charging process. This is normal and does not represent a risk. Use only the adapter plug unit provided for the charging station. The battery status is shown on the display. When the battery capacity is nearly exhausted, the battery symbol (🔋) will flash in the display and you will hear the battery warning sound (if the option is switched on) / menu item "HS Settings / Tone Setup / Battery Low". You still have up to ten minutes of talk time.

Setting the time and date on the handset

At initial operation the handset does not have the correct time (e.g. for entries in the call list). Date and time are set through the menu item "Clock/Alarm / Date & Time".

Setting the display language

The display language is available in 4 languages. The default setting is "German (Deutsch)". Set the language using the menu item "MT einstellen / Sprache".

Auto Answer

If this function is activated, an incoming call is taken when the handset is removed from the base station. The automatic answering function is activated and deactivated using the menu item "HS Settings / Auto Answer".

3 Operating Elements

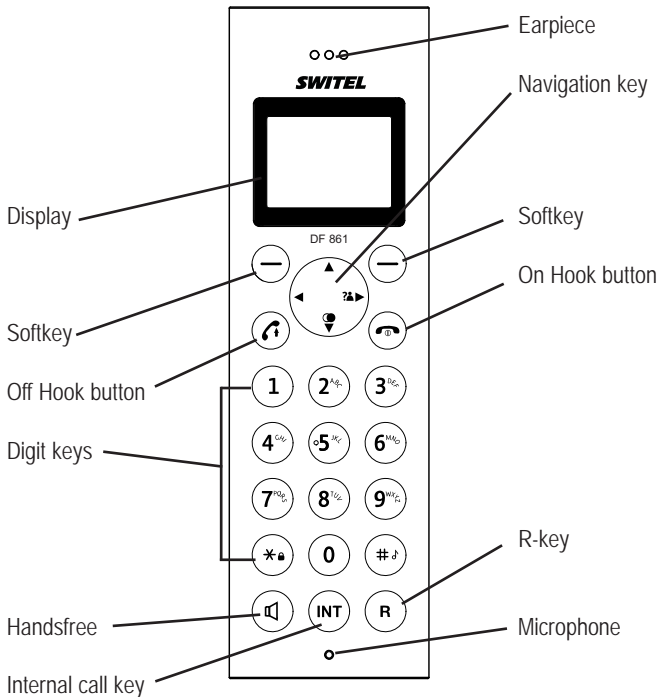

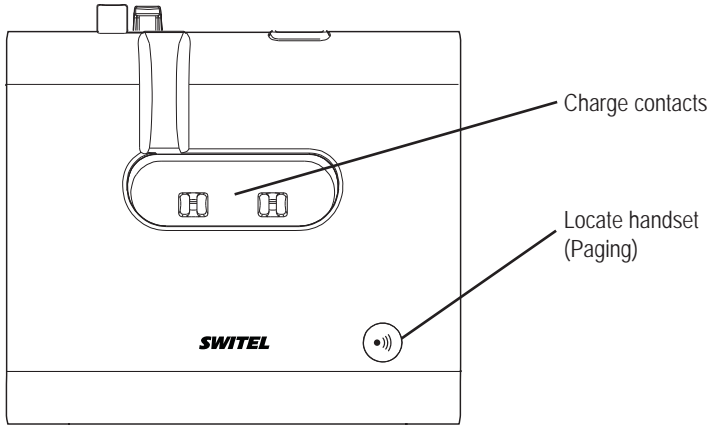















4 Preliminary Information

This chapter provides basic information on using the operating instruction manual and the telephone.

Description of operating sequences in the manual

Display	Description
	Press the button depicted.
	Enter digits or letters.
	Handset rings.
	Base station rings.
	Remove the handset from the base station.
	Place the handset in the base station.
Name?	Depicts text in the display.
	Depicts icons in the display.

Icons in the handset display

Icon	Description
	On: The connection to the base station is good. Flashing: The connection to the base station is lost.
	On: Indicates the battery charge status. Scrolling while handset in base: Battery is being charged.
	Some segments not displayed: Battery needs charging.
	Flashing: Battery should be charged immediately. On: A call is currently being made.
	Flashing: A call has been received.
	Handsfree mode is activated.
	The ringing tone has been switched off.



On: The alarm function is activated.

Flashing: The alarm is ringing.



The key lock is activated



You can conduct an internal call (only with several handsets registered on the base station):

Incoming internal call.



While browsing call list: New call.



Character overflow left/right. Use the left-/right arrow key to scroll.

The functions assigned to the two **softkeys** are shown in the lowest line of the display. The key function changes automatically according to the operating status of the handset.

Menu

Accessing the menu.

PB

Accessing the phonebook.

Select

Selecting the respective entry/menu item.

OK

Confirmation.

Back

Back to the previous menu or cancel programming.

Cancel/Clear

Backwards deleting of characters during entry (brief pressing deletes one character, long pressing deletes the whole line).

Functions of the arrow keys



In menu mode / in lists (phonebook, caller list, redial list): Press to scroll up.

During a call: Press to increase volume.



In editing / pre-dial mode: Press to move the cursor one character to the left.



In idle mode: Press to access the call list.

In editing / pre-dial mode: Press to move the cursor one character to the right.



In idle mode: Press to access the redial list.

During a call: Press to decrease volume.

In menu mode / in lists (phonebook, caller list, redial list): Press to scroll down.

Special key functions



While entering a telephone number: a long press inserts a dialling pause.



In idle mode: a long press will activate/deactivate keypad lock.

In editing mode: a long press switches the character set (Latin/Russian/Greek), tables -> appendix.

During a call: temporary switch to DTMF if pulse is activated.



In idle mode: a long press turns on/off the handset ringer.

In editing mode: a long press toggles between uppercase and lowercase character input.

Standby mode

All descriptions in this operating manual assume that the handset is in Standby mode. The system switches to Standby mode by pressing the  button.

Low-radiation operation (ECO mode)



The ECO mode reduces emissions by up to 75 % in talk mode (depending on the distance of the handset to the base station) compared to a standard DECT cordless telephone.

Navigating in the menu

All the functions can be accessed via the various menus. The entire menu structure can be found in the appendix.

The softkeys and the arrow keys are used for navigation in the menu.

The menu is opened with the left softkey **Menu**.

Use the arrow keys  and  to move within the menu.

Press the softkey **Select** to open a sub menu.

Press **Back** to go back to the previous level.

By pressing the On-hook key you will return to standby state.

5 Telephoning

Taking a call

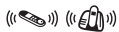
 Your phone is ringing.

If the handset is **not** in the base station:

 /  Press the Off Hook button or the Handsfree button.

If the handset is in the base station and **Auto Answer** is **not** activated:

 /  Remove the handset from the base and press the Off Hook button or the Handsfree button.

If the handset is in the base station and **Auto Answer** is activated:

 Remove the handset from the base - the call will be taken automatically.

Making a call



 Enter the telephone number.

Delete wrong characters pressing **Clear**.

 /  The telephone number is being dialled.

 You can also press the Off Hook button and you will hear the dialling tone. The entered number will be dialled immediately. It is not possible to correct wrong digits individually using this dialling procedure.

Ending a call

 /  Press the On Hook button or replace the handset in the base station.

Telephoning

Redial

 Your handset saves the last 20 dialled telephone numbers. If a caller is stored in your phone book, the name will be displayed.

Whilst the name is displayed to show the respective number press **Select**.



Open the redial list.



Select an entry.



Dial out the telephone number.

Making a call from the call list

 Your handset saves the numbers of the last 30 incoming calls in the call list. If a caller is stored in your phone book, the name will be displayed.

Whilst the name is displayed to show the respective number press **Select**.

Saving can only take place if the function "Phone number transmission (CLIP)" is available at your connection and caller ID is not suppressed by the caller or was not transmitted for any other reason.



Open the call list.



Select an entry.



Dial out the telephone number.

Making a call from the phone book

 You can store up to 100 entries in the phone book.

For creating entries see section "Phone book".

PB

Open the telephone book.



Select the name of the person you wish to call.



Dial out the telephone number.

Call timer

Your handset automatically times the duration of every call in hours, minutes and seconds.

Setting the earpiece/loudspeaker volume



During a call you can adjust the volume in 5 levels (if telephoning "normally" -> earpiece volume, with hands-free -> loudspeaker volume).

These separate settings will remain at the last selected level when you end the call.

Muting the microphone

Mute

During a call you can switch your handset's microphone off.

The display shows **Call Muted**.

Unmute

To unmute press the softkey again.

Internal calls

Internal calls, transfers and conference calls are only possible if multiple handsets are registered. If this is not the case **Unavailable** will be indicated on the display.

Making an internal call

INT

Press the **INT** key. If two handsets are registered to the base station the other handset will be called immediately.

If three or more handsets are registered to the base station their internal numbers will be displayed (for example 2 3 4).

Use the arrow keys / to select the handset and press **Select**.



If you select "9" in the case of several registered handsets all will be called at the same time.

Transferring an external call to another handset

During an external call . . .

INT

Press the **INT** key.

Select the handset using the arrow keys / and press **Select**.

The external call is put on hold. When the called handset answers you can announce the call transfer.



Press the On-Hook key. The call will be transferred.

Broker's call

During an external call . . .

INT

Press the **INT** key.

Select the handset using the arrow keys / and press **Select**.

The external call is put on hold.

INT

Use the **INT** key to switch between the calls.

3-Party Conference

During "Broker's call" . . .

You talk to the internal subscriber:

INT

Press and hold the **INT** key until **Conference** appears in the display.

 Any handset hangs up during a conference call will leave the other handset still in connection with the external call.

6 Other features

Key lock

 The key lock prevents functions assigned to buttons being activated inadvertently. Incoming calls can still be taken in the normal way even when the key lock function is activated.



Press and hold down the star-key until the key lock icon appears in the display.



For unlocking the keypad again press and hold down the star-key until the icon disappears.

Switching the handset ringer on/off

 You can turn off the ringer via the menu item "HS Settings / Ring Setup / Ring Volume" as well.



Press and hold down the #-key until the  icon appears in the display.



For turning the ringer on again press and hold down the #-key until the icon disappears.

Switching off the handset

 You can switch off the handset for saving battery capacity.



Press and hold down the On Hook-button. After a few seconds the handset will be switched off. The display illumination goes down.



For switching the handset on again press and hold down the On Hook-button until you hear a short beep and the display is illuminated.

7 Call list / Redial

Editing the call list



Open the call list.



Select an entry and press **Select**.

The respective call's date and time is shown.

Menu

Press the **Menu** softkey.



Select one of the following options and confirm with **Select**:

Add to PB

The telephone number will be stored in the telephone book.

Enter a name, confirm or edit the telephone number and select a ringtone melody for the entry.

Delete

The entry will be deleted.

Delete All

The complete list will be deleted after a confirmation query.



You can access the call list via the menu as well:

(Menu  /  **Call List / Select**).

Editing the redial list



Open the redial list.



Select an entry and press **Select**.

Menu

Press the **Menu** softkey.



Select one of the following options and confirm with **Select**:

Add to PB

The telephone number will be stored in the telephone book.

Enter a name, confirm or edit the telephone number and select a ringtone melody for the entry.

Delete

The entry will be deleted.

Delete All

The complete list will be deleted after a confirmation query.

8 Phone book

 Your phone can store up to 100 private phonebook entries with names and numbers. You can also select different ringtones for your phonebook entries.

Always enter the phone numbers with the area code; this enables a correct display of the respective caller for whom there is an existing entry and whose phone number transmission to your connection is available.

Creating a new entry

Menu Press the **Menu** softkey.



Select **Phonebook** and press **Select**.



Select **Add** if necessary and press **Select**.



Enter the name (max. 12 digits).

Letters are also imprinted on the digit keys. Letters, digits and special characters are entered by pressing the relevant key the respective number of times.

A long press on the #-key toggles between uppercase and lowercase character input.

After a short time the cursor skips one position forwards.

Having entered the name press .



Enter the phone number (max. 24 digits). If your telephone is connected to a PBX start the telephone number with the access code. If a dialling pause is needed, press after the access code the **0** key for approx. 2 sec. A **P** appears in the display.

Having entered the number press .







Select a melody for the entry.

OK

Confirm with **OK**.

Editing telephone book entries

Menu	Press the Menu softkey.
 / 	Select Phonebook and press Select .
 / 	Select one of the following options and confirm with Select : All entries are shown. Scroll to the desired entry. Press Select to view the details of the selected entry. Press Menu to edit or delete the entry.
View	
Add	You can create a new entry.
Edit	All entries are shown. Scroll to the desired entry. Press Select to edit the selected entry. Use the Clear softkey to delete characters and numbers then add new characters and numbers as required. Please refer to "Creating a new entry".
Delete	All entries are shown. Scroll to the desired entry. Press Select to delete the entry immediately.
Delete All	Press Select to delete all entries after a confirmation query.
PB Status	The current allocation will be displayed (e.g. 7/100 Used : 7 of 100 possible entries are present).

9 Setting the telephone

Date/Time

Menu



Press the **Menu** softkey.



Select **Clock/Alarm** and press **Select**.



Select **Date & Time** and press **Select**.

Date Format

Select one of the following options and confirm with **Select**:

You can select your desired date format:

(DD-MM-YYYY or MM-DD-YYYY).

Time Format

You can select your desired time format: (24 or 12 hours).

Set Date

Enter the date using the digit keys.

Set Time

Enter the time using the digit keys. If entering the time using a 12 hour clock then use the star key to select AM or PM.

 In case of mains failure this setting will be deleted when simultaneously the handset is switched off or the battery is empty.

Alarm

Menu



Press the **Menu** softkey.



Select **Clock/Alarm** and press **Select**.



Select **Alarm** and press **Select**.

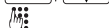

Select **Alarm On** and press **Select**.



Enter the alarm time using the digit keys and press **OK**.

Select **Snooze On** or **Snooze Off** and press **Select**. If "Snooze" is turned on it means that the alarm signal is being repeated after 2 minutes until this function is terminated by pressing and holding the off hook button.

If "Snooze" is turned off the alarm signal is given once at the specified time. To confirm the alarm signal, press any key.

Setting the telephone



Select **Alarm Melody** and press **Select**.

Select a melody and press **Select**.

Handset Audio Setup

Menu

Press the **Menu** softkey.



Select **HS Settings** and press **Select**.



Select **Audio Setup** and press **Select**.



Select one of the following options and confirm with **Select**:

Speaker Volume Select the volume for handsfree operation.

Ear Volume Select the volume for the earpiece.

 These settings can also be made during a call (-> "Telephoning / Setting the earpiece/loudspeaker volume").

Setting the ringer for the handset

Menu

Press the **Menu** softkey.



Select **HS Settings** and press **Select**.



Select **Ring Setup** and press **Select**.



Select one of the following options and confirm with **Select**:

Internal Ring Select a melody for internal calls.

External Ring Select a melody for external calls.

Ring Volume Select the volume. If you select "Volume Off" the respective icon appears in the display.

Setting the alert tones

Menu



Press the **Menu** softkey.



Select **HS Settings** and press **Select**.



Select **Tone Setup** and press **Select**.

Key Tone

Switch the keytone on or off.

Battery Low

Switch the alert tone on or off. The tone sounds if "Low battery" is detected.

Out of Range

Switch the alert tone on or off. The tone sounds if "Out of range" is detected.

Setting the display language

Menu



Press the **Menu** softkey.



Select **HS Settings** and press **Select**.



Select **Language** and press **Select**.

Select a language and press **Select**.

Setting the handset name

Menu

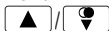

Press the **Menu** softkey.



Select **HS Settings** and press **Select**.

Select **Rename HS** and press **Select**.



Delete the old name with **Clear**, enter a new name using the digit keys and confirm with **OK**.

Setting the telephone

Setting the display contrast

Menu



Press the **Menu** softkey.

Select **HS Settings** and press **Select**.

Select **Contrast** and press **Select**.

Select a contrast level and press **Select**.

Setting Auto Answer

Menu



Press the **Menu** softkey.

Select **HS Settings** and press **Select**.

Select **Auto Answer** and press **Select**.

Select whether the automatic answer function will be on or off and confirm with **Select**.

 If Auto Answer is on an incoming call will immediately be taken when the handset is taken from the base.

Select a base station

Menu



Press the **Menu** softkey.

Select **HS Settings** and press **Select**.

Select **Select Base** and press **Select**.

You see a list of base stations your handset is already registered to. The relevant base is marked with a "*". Select a base and press **Select**.

 Only base stations are shown your handset is already registered to.

Resetting the handset

Menu



Press the **Menu** softkey.

Select **HS Settings** and press **Select**.

Select **HS Default** and press **Select**.

Enter the relevant PIN (default 0 0 0 0) and press **OK**.

Confirm the confirmation query with **OK**.

The entries in phonebook will not be deleted.

Setting the ringer for the base station

Menu



Ring Melody

Ring Volume

Press the **Menu** softkey.

Select **Base Settings** and press **Select**.

Select **Ring Setup** and press **Select**.

Select one of the following options and confirm with **Select**:

Select a melody and press **Select**.

Select the volume and press **Select**.

Setting the dial mode

Menu



Press the **Menu** softkey.

Select **Base Settings** and press **Select**.

Select **Dial Mode** and press **Select**.

Select **Tone** or **Pulse** and press **Select**.

In most situations the **Tone** option should be selected.

Setting the telephone

Setting the Flash Time

Menu



Press the **Menu** softkey.

Select **Base Settings** and press **Select**.

Select **Flash Time** and press **Select**.

Select **Short** (100 ms), **Medium** (300 ms) or **Long** (600 ms) and confirm with **Select**.

Editing the PIN

Menu

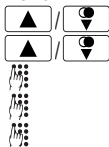

Press the **Menu** softkey.

Select **Base Settings** and press **Select**.

Select **Modify PIN** and press **Select**.

Enter the relevant PIN (default 0 0 0 0) and press **OK**.

Enter a new PIN and press **OK**.

Enter the new PIN again and press **OK**.

The four digit PIN protects some settings against unauthorized changes. If you have forgotten your PIN please call our service hotline.

Resetting the base station

Menu

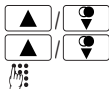

Press the **Menu** softkey.

Select **Base Settings** and press **Select**.

Select **BS Default** and press **Select**.

Enter the relevant PIN (default 0 0 0 0) and press **OK**.

Confirm the confirmation query with **OK**.

The entries in phonebook will not be deleted. The registration of handsets will not be changed.

10 Registering/de-registering handsets

Five handsets can be registered to a base station. The handsets delivered with your telephone are already registered. To register a "foreign" handset please refer to it's user manual.

Registering a handset of the same type

Menu



Press the **Menu** softkey.



Select **Registration** and press **Select**.



Select a base station and press **Select**. Base stations to which the handset is already registered are shown in outlined characters. The relevant base is marked with a *.



Enter the relevant PIN for the base, the new handset should be registered on, and press **OK**.

Press and hold down the paging key on the base station until a short beep is to be heard (approx. 5 sec).

After a few seconds the antenna icon on the display is on.
The handset is registered.

Deleting a handset

Menu



Press the **Menu** softkey.



Select **Base Settings** and press **Select**.



Select **Delete HS** and press **Select**.



Enter the relevant PIN (default 0 0 0 0) and press **OK**.

Select a handset and press **Select**.

You cannot de-register the handset you are currently using.

11 PBX / Supplementary Services

PBX

If the telephone is connected to a private branch exchange, functions such as transferring calls and automatic call back can be used via the R button. Refer to the operating manual provided with your private branch exchange as to which Flash time must be set in order to use these functions. The sales outlet where you purchased the exchange can provide information as to whether the telephone will work properly with the exchange.

Please remember to enter the access code and a necessary dialling pause (a long press "0") when creating phone book entries.

Supplementary services

Your telephone supports supplementary services provided by your telephone network provider, such as brokering, call waiting and conference facilities.

These supplementary services can be used via the R-button.

Please contact your telephone network provider regarding which Flash time must be set to use the supplementary services. Contact your telephone network provider with regard to enabling supplementary services.

12 Appendix

Menu Structure

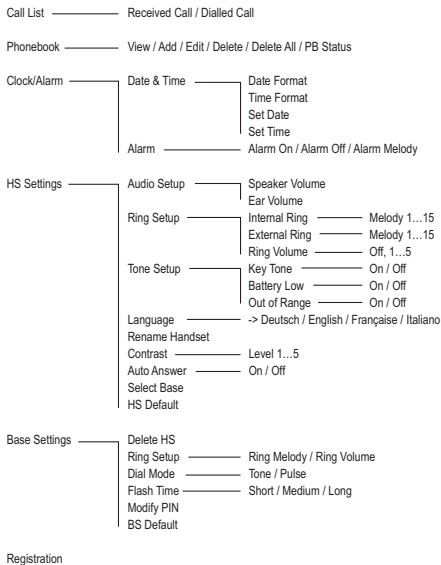

Appendix

Character Sets

Character Set Latin / Uppercase

0	SP	0	-	+	=	_	()	"	'	[]	{	}	<	>	/	\	^	~	
1	1	.	,	:	;	!	ı	?	ı	*	#	&	%	\$	€	£	@	¤	§		
2	A	B	C	2	À	Á	Â	Ã	Ä	Å	Ą	Æ	Ç	Ć	Ĉ						
3	D	E	F	3	Ď	È	É	Ê	Ë	Ě	Ĕ	Ė									
4	G	H	I	4	Ğ	Ì	Í	Î	Ï	Ī	ı	Ĭ									
5	J	K	L	5	Ł	Ł	Ł														
6	M	N	O	6	Ñ	Ń	Ň	Ò	Ó	Ô	Õ	Ö	Ŏ	Ő	Ø						
7	P	Q	R	S	7	Ř	Ŕ	Ś	Ş	Š	ß										
8	T	U	V	8	Ť	Ù	Ú	Û	Ü	Ū	Ŭ	Ů									
9	W	X	Y	Z	9	Ŵ	Ŷ	Ý	Ÿ	Ž	Ż	Ž									

Character Set Latin / Lowercase

0	SP	0	-	+	=	_	()	"	'	[]	{	}	<	>	/	\	^	~	
1	1	.	,	:	;	!	ı	?	ı	*	#	&	%	\$	€	£	@	¤	§		
2	a	b	c	2	à	á	â	ã	ä	å	ą	æ	ç	ć	ĉ						
3	d	e	f	3	ď	è	é	ê	ë	ě	ĕ	ė									
4	g	h	i	4	ğ	ì	í	î	ï	ĭ	ı	ĭ									
5	j	k	l	5	ł	ł	ł														
6	m	n	o	6	ñ	ń	ň	ò	ó	ô	õ	ö	ŏ	ő	ø						
7	p	q	r	s	7	ř	ŕ	ś	ş	š	ß										
8	t	u	v	8	ť	ù	ú	û	ü	ŭ	ŭ	ů									
9	w	x	y	z	9	ŵ	ŷ	ý	ÿ	ž	ż	ž									

Character Set Russian / Uppercase

0	SP	0	-	+	=	_	()	"	'	[]	{	}	<	>	/	\	^	~	
1	1	.	,	:	;	!	і	?	¿	*	#	&	%	\$	€	£	@	¤	§		
2	А	Б	В	Г	2																
3	Д	Е	Ж	З	3																
4	И	Й	К	Л	4																
5	М	Н	О	П	5																
6	Р	С	Т	У	6																
7	Ф	Х	Ц	Ч	7																
8	Ш	Щ	Ъ	Ы	8																
9	Ь	Э	Ю	Я	9																

Character Set Russian / Lowercase

0	SP	0	-	+	=	_	()	"	'	[]	{	}	<	>	/	\	^	~	
1	1	.	,	:	;	!	і	?	¿	*	#	&	%	\$	€	£	@	¤	§		
2	а	б	в	г	2																
3	д	е	ж	з	3																
4	и	й	к	л	4																
5	м	н	о	п	5																
6	р	с	т	у	6																
7	ф	х	ц	ч	7																
8	ш	щ	ъ	ы	8																
9	ь	э	ю	я	9																

Appendix

Character Set Greek / Uppercase

0	SP	0	-	+	=	_	()	"	'	[]	{	}	<	>	/	\	^	~	
1	1	.	.	:	:	!	!	?	¿	*	#	&	%	\$	@	£	@	¤	§		
2	A	B	Γ	2																	
3	Δ	E	Z	3																	
4	H	Θ	I	4																	
5	K	Λ	M	5																	
6	N	Ξ	O	6																	
7	Π	P	Σ	7																	
8	T	Υ	Φ	8																	
9	X	Ψ	Ω	9																	

Character Set Greek / Lowercase

0	SP	0	-	+	=	_	()	"	'	[]	{	}	<	>	/	\	^	~	
1	1	.	.	:	:	!	!	?	¿	*	#	&	%	\$	@	£	@	¤	§		
2	α	β	γ	2																	
3	δ	ε	ζ	3																	
4	η	θ	ι	4																	
5	κ	λ	μ	5																	
6	ν	ξ	ο	6																	
7	π	ρ	ς	σ	7																
8	τ	υ	φ	8																	
9	χ	ψ	ω	9																	

In Case of Problems

Should problems arise with the telephone, please refer to the following information first. In the case of technical problems, you can contact our hotline service, Tel. 0900 00 1675 within Switzerland (Costs for call from Swisscom landline at time of going to print: CHF 2.60/min). In the case of claims under the terms of guarantee, contact your sales outlet. There is a 2 year period of guarantee.

- After pressing the on hook button, no ring tone is audible, the line is not engaged.
 - Check the telephone connector on the base station and on the wall socket.
 - Check power connector on the base station and on 230 V.
 - The line is being occupied by another handset. Wait until the connection is terminated.
- Display: "SEARCHING".
 - Check power connector on the base station and on 230 V.
 - Reduce range.
 - Register handset.
- Base station does not ring.
 - Ringtone turned off -> turn on.
- No display.
 - Handset turned off -> turn on.
 - Battery empty -> recharge.

Appendix

Default settings

Call list	No entry
Phonebook	No entry
Alarm	Off
Ringer handset	Internal call: Melody 2 External call: Melody 1 Volume: 3
Ringer base	Melody 1 Volume: 3
Tone setup	Key tone: On Battery tone: On Out of range: On
Language	German
Handset name	DF86x
Auto answer	On
Date & Time	Date format: DD-MM-YYYY Time format: 24 hours
Dial mode	Tone
Flash time	Short (100 ms)
PIN	0 0 0 0

Technical data

Standard: DECT / GAP

Number of channels: 120 duplex channels

Frequencies: 1880 MHz to 1900 MHz

Duplex mode: Time division multiplex, 10ms frame length

Channel spacing: 1728 kHz

Bit rate: 1152 kBit / s

Modulation: GFSK

Voice encoding: 32 kBit / s

Transmitter power: 10 mW (average power per channel)

Range: up to 300 m outside, up to 50 m inside buildings

Electricity supply base station:

100-240 V AC (adapter plug S002CV0600030), 6 V DC / 300 mA

Electricity supply charger:

100-240 V AC (adapter plug S002CV0600030), 6 V DC / 300 mA

Handset: Operating time: Stand-by time / Talk time

500 mAh = up to 100 h / up to 10 h

Charging time: approx. 14 hours

Operating temperature for handset operation:

5°C to 40°C ; 20 % to 75 % rel. humidity

Operating temperature for base station operation:

5°C to 40°C ; 20 % to 75 % rel. humidity

Storage temperature: -10°C to +60°C

Dial mode: Tone / Pulse

R-key : Flash time (100 ms/300 ms/600 ms)

Base station dimensions (mm): L / W / H = approx. 110 x 95 x 29/45

Handset dimensions (mm): L / W / H = approx. 161 x 48 x 16

Telephone line cord:

TSV on Pin 3 and 4 according to CTR 37 (Euro)

Adapter plug: European-type mains connector

Declaration of Conformity



This device fulfils the requirements stipulated in the EU directives:

- 1999/5/EU directive on radio equipment and telecommunications terminal equipment and the mutual recognition of their conformity.
- 2005/32/EU directive "Energy-using products".
- Regulation 1275/2008 "Electric power consumption in standby- and off-state".
- Regulation 278/2009 "External power supplies without load and their average efficiency in use".

Conformity with the above mentioned directives is confirmed by the CE symbol on the device.

To view the complete Declaration of Conformity, please refer to the free download available on our web site www.switel.com.

Maintenance

Clean the housing surfaces with a soft, fluff-free cloth.

Do not use any cleaning agents or solvents.

Guarantee

SWITEL equipment is produced and tested according to the latest production methods. The implementation of carefully chosen materials and highly developed technologies ensure trouble-free functioning and a long service life. The terms of guarantee do not apply where the cause of equipment malfunction is the fault of the telephone network operator or any interposed private branch extension system. The terms of guarantee do not apply to the batteries or power packs used in the products. The period of guarantee is 24 months from the date of purchase.

All deficiencies related to material or manufacturing errors within the period of guarantee will be redressed free of charge. Rights to claims under the terms of guarantee are annulled following tampering by the purchaser or third parties. Damage caused as the result of improper handling or opera-

tion, normal wear and tear, incorrect positioning or storage, improper connection or installation or Acts of God and other external influences are excluded from the terms of guarantee. In the case of complaints, we reserve the right to repair defect parts, replace them or replace the entire device. Replaced parts or devices become our property. Rights to compensation in the case of damage are excluded where there is no evidence of intent or gross negligence by the manufacturer.

If your device shows signs of defect during the period of guarantee, please return it to the sales outlet in which you purchased the SWITEL device together with the purchase receipt. All claims under the terms of guarantee in accordance with this agreement can only be asserted at the sales outlet. No claims under the terms of guarantee can be asserted after a period of two years from the date of purchase and hand-over of the product.

Index

A

Alarm	.23
Alert tones	.25
Audio Setup	.24
Auto Answer	.7, 26

B

Broker's call	.18
---------------	-----

C

Call list	.16, 20
Call timer	.17
Character Sets	.32
Charging the batteries	.6
Conference	.18
Connecting the base station	.5
Connecting the charging station	.5

D

Date / Time	.6, 23
Declaration of Conformity	.38
Dial mode	.27
Display contrast	.26
Display language	.7
Disposal	.3

E

Earpiece/loudspeaker volume	.17
ECO mode	.14
Electrical consumption	.4

Ending a call	.15
---------------	-----

F

Flash Time	.28
------------	-----

G

Guarantee	.38
-----------	-----

H

Handset name	.25
--------------	-----

I

Icons	.10
In Case of Problems	.35
Inserting the batteries	.6
Installation location	.2
Intended use	.2
Internal calls	.17

K

Key lock	.19
----------	-----

L

Language	.25
Low-radiation operation	.14

M

Maintenance	.38
Making a call	.15
Medical equipment	.3
Menu Structure	.31
Muting the microphone	.17

N

Navigating in the menu14

P

Package contents 4

PBX30

Phone book16, 21

PIN28

Power adapter plug 2

Power failure 2

R

Rechargeable batteries 2

Redial16, 20

Registering/de-registering handsets .29

Resetting the base station 28

Resetting the handset 27

Ringer24, 27

S

Safety Information 2

Select a base station 26

Standby mode14

Supplementary services30

Switching off the handset19

Switching the handset ringer on/off .19

T

Technical data37

Transferring an external call18

SWITEL

Declaration of conformity

Dieses Gerät entspricht der europäischen R&TTE Richtlinie. Für die komplette Konformitätserklärung nutzen Sie bitte den kostenlosen Download von unserer Website www.switel.com.

Cet équipement est conforme à la directive européenne R&TTE. Pour obtenir la déclaration de conformité intégrale, veuillez vous servir du téléchargement gratuit de notre site Internet www.switel.com.

Quest'apparecchiatura è conforme alla direttiva europea R&TTE. Per la dichiarazione di conformità completa si prega di voler usufruire del servizio gratuito di download dal nostro sito Internet www.switel.com.

This equipment complies with the European R&TTE directive. To view the complete Declaration of Conformity, please refer to the free download available at our web site: www.switel.com.

Service Hotline

Bei technischen Problemen können Sie sich an unsere Service-Hotline unter Tel. 0900 00 1675 innerhalb der Schweiz (Kosten Swisscom bei Drucklegung: CHF 2.60/min) wenden.

S'il s'agit de problèmes techniques, vous pouvez vous adresser à notre hotline de service en Suisse en appelant le numéro 0900 00 1675 (frais Swisscom à la date d'impression de ce manuel : CHF 2.60/min).

In caso di problemi tecnici è possibile rivolgersi alla nostra hotline di assistenza tecnica chiamando al numero 0900 00 1675 valido per la Svizzera (spese da rete Swisscom alla data di stampa: CHF 2.60 / min).

In the event of technical problems, you can contact our hotline service, Tel. 0900 00 1675 within Switzerland (cost via Swisscom at time of going to print: CHF 2.60/min).

