

SWITEL

COMMUNICATION PRODUCTS

Strahlungsarmes schnurloses DECT-/GAP-Telefon mit Anrufbeantworter
Téléphone DECT/GAP sans fil, à faible rayonnement et avec répondeur
Telefono cordless DECT/GAP a basse radiazioni con segreteria telefonica
Low-radiation cordless DECT/GAP telephone with answering machine

DFT 817x



Bedienungsanleitung
Mode d'emploi
Istruzioni per l'uso
Operating Instructions

D

F

I

GB

SWITEL

Bedienungsanleitung 3

Mode d'emploi 31

Istruzioni per l'uso 61

Operating Instructions 91

Declaration of Conformity 120

1	Sicherheitshinweise	4
2	Telefon in Betrieb nehmen	5
3	Bedienelemente	7
4	Einführende Informationen	8
5	Telefonieren	10
6	Telefonbuch / Anrufliste	12
7	Anrufbeantworter	13
8	Nebenstellenanlagen / Zusatzdienste ..	17
9	Menüstruktur	18
10	Besondere Funktionen	22
11	SMS	23
12	Erweitern des Telefonsystems	24
13	Falls es Probleme gibt	25
14	Technische Eigenschaften	26
15	Pflegehinweise / Garantie	28
16	Stichwortverzeichnis	29

Sicherheitshinweise

1 Sicherheitshinweise

Lesen Sie diese Bedienungsanleitung sorgfältig durch.

Bestimmungsgemäße Verwendung

Dieses Telefon ist geeignet zum Telefonieren innerhalb eines Telefonnetzes. Jede andere Verwendung gilt als nicht bestimmungsgemäß. Eigenmächtige Veränderungen oder Umbauten sind nicht zulässig. Öffnen Sie das Gerät in keinem Fall selbst und führen Sie keine eigenen Reparaturversuche durch.

Aufstellungsort

Vermeiden Sie Belastungen durch Rauch, Staub, Erschütterungen, Chemikalien, Feuchtigkeit, Hitze oder direkte Sonneneinstrahlung.

Verwenden Sie das Mobilteil nicht in explosionsgefährdeten Bereichen.

Netzteil



Achtung: Verwenden Sie nur das mitgelieferte Steckernetzteil, da andere Netzteile das Telefon beschädigen können. Sie dürfen den Zugang zum Steckernetzteil nicht durch Möbel oder andere Gegenstände versperren.

Aufladbares Akkupack



Achtung: Werfen Sie Akkus nicht ins Feuer. Verwenden Sie nur Akkus des gleichen Typs! Achten Sie auf die richtige Polung! Bei verkehrter Polung der Akkus besteht beim Aufladen Explosionsgefahr.

Stromausfall

Bei Stromausfall kann mit dem Telefon nicht telefoniert werden. Halten Sie für Notfälle ein schnurgebundenes Telefon bereit, welches ohne externe Stromversorgung arbeitet.

D

Medizinische Geräte



Achtung: Benutzen Sie das Telefon nicht in der Nähe von medizinischen Geräten. Eine Beeinflussung kann nicht völlig ausgeschlossen werden.

DECT¹-Telefone können in Hörgeräten einen unangenehmen Brummtönen verursachen.

Entsorgung

Wollen Sie Ihr Gerät entsorgen, bringen Sie es zur Sammelstelle Ihres kommunalen Entsorgungsträgers (z. B. Wertstoffhof). Das nebenstehende Symbol bedeutet, dass Sie das Gerät auf keinen Fall in den Hausmüll werfen dürfen! Nach dem Elektro- und Elektronikgerätegesetz sind Besitzer von Altgeräten gesetzlich gehalten, alte **Elektro- und Elektronikgeräte** einer getrennten Abfallerfassung zuzuführen.



Akkus entsorgen Sie beim batterievertreibenden Handel sowie bei zuständigen Sammelstellen, die entsprechende Behälter bereitstellen.



Verpackungsmaterialien entsorgen Sie entsprechend den lokalen Vorschriften.

¹ **DECT:** Digital Enhanced Cordless Telecommunication = Standard für kabellose Telefone.

2 Telefon in Betrieb nehmen

Sicherheitshinweise



Achtung: Lesen Sie vor der Inbetriebnahme unbedingt die Sicherheitshinweise in Kapitel 1.

Verpackungsinhalt prüfen

Zum Lieferumfang gehören:

Inhalt	DFT 817x-Modell			
	8171	8172 ¹	8173 ¹	8174 ¹
Basisstation (Anrufbeantworter) mit Netzteil	1	1	1	1
Ladestation mit Netzteil	-	1	2	3
Mobilteil	1	2	3	4
Telefonanschlusskabel	1	1	1	1
Akkupack	1	2	3	4
Bedienungsanleitung	1	1	1	1

¹ Unter www.switel.com erfahren Sie, ob dieses Telefon-Set bereits erhältlich ist.

Basisstation anschließen



Achtung: Stellen Sie die Basisstation mit einem Mindestabstand von 1 m zu anderen elektronischen Geräten auf, da es sonst zu gegenseitigen Störungen kommen kann.

Schließen Sie die Basisstation wie auf der Skizze abgebildet an. Verwenden Sie aus Sicherheitsgründen nur das mitgelieferte Netzteil sowie das beigefügte Telefonanschlusskabel.

Telefonanschlussdose

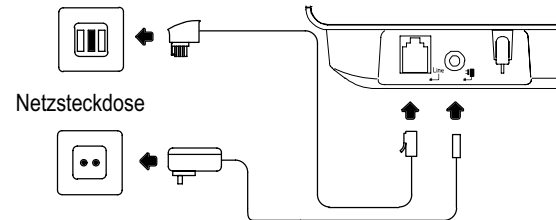

Achtung: Verwenden Sie für die Basisstation mit Anrufbeantworter das Netzteil Modell Nr. VD060060I, mit den Ausgangsdaten: 6 V, 600 mA.

Ladestation anschließen²

Schließen Sie die Ladestation wie auf der Skizze abgebildet an. Verwenden Sie aus Sicherheitsgründen nur das mitgelieferte Netzteil.

Netzsteckdose

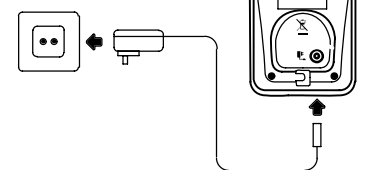

Achtung: Verwenden Sie für die Ladestation das Netzteil Modell Nr. SY-06030-GS, mit den Ausgangsdaten: 6 V, 300 mA.

² Gilt nur für Telefonsets mit mindestens zwei Mobilteilen
 "Verpackungsinhalt prüfen" auf Seite 5.

Telefon in Betrieb nehmen

Akkupack einlegen

Öffnen Sie das Akkufach.
Stecken Sie den Stecker des Akkupacks in die Buchse im Akkufach. Legen Sie das Akkupack in das Akkufach ein. Verwenden Sie nur das mitgelieferte Akkupack. Achten Sie darauf, dass Sie das Kabel nicht einklemmen. Schließen Sie das Akkufach.

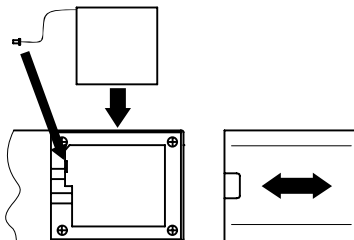

Akkupack aufladen

 Stellen Sie das Mobilteil bei der ersten Inbetriebnahme für **mindestens 20 Stunden** in die Basisstation / Ladestation.

Das Mobilteil erwärmt sich beim Laden. Dies ist normal und ungefährlich. Laden Sie das Mobilteil nicht mit fremden Aufladegeräten. Der aktuelle **Akkuladezustand** wird im Display angezeigt:



Voll



Halb



Schwach



Leer

Datum und Uhrzeit des Mobilteils einstellen

Datum und Uhrzeit stellen Sie über das Menü ein. Auf Seite 20 finden Sie die Position im Menü.

Displaysprache einstellen

Die Displaysprache ist in Deutsch, Englisch, Italienisch und Französisch vorhanden. Sie können die Sprache über das Menü einstellen. Auf Seite 19 finden Sie die Position im Menü.

Automatische Anrufannahme / Direktannahme

Haben Sie die Funktion aktiviert, wird ein Anruf automatisch beim Herausnehmen des Mobilteils aus der Basisstation angenommen. Die automatische Anrufannahme wird über das Menü aktiviert oder deaktiviert. Auf Seite 19 finden Sie die Position im Menü.

Nebenstellenanlagen

Auf Seite 17 erhalten Sie weitere Informationen, falls Sie Ihr Telefon an eine Nebenstellenanlage anschließen möchten.

Datum und Uhrzeit des Anrufbeantworters einstellen



Das Datum und die Uhrzeit Ihres Anrufbeantworters werden automatisch vom Mobilteil übernommen.

Strahlungsreduzierung (ECO-Mode)

 Werkseinstellung = ECO Mode → Ein

















Sowohl im Gesprächs- als auch im Bereitschaftsmodus wird die Strahlung bei eingeschaltetem ECO-Mode im Vergleich zu Standard-DECT-Schnurlostelefonen erheblich verringert.

 Bei Bedarf können Sie die Reichweite des Telefonsystems erhöhen, indem Sie den ECO-Mode ausschalten  Seite 19 (ECO Mode → Aus).

3 Bedienelemente

Die Tasten Ihres Telefons werden in dieser Bedienungsanleitung nachfolgend mit vereinheitlichten umrandeten Symbolen dargestellt. Leichte Abweichungen der Tastsymbole Ihres Telefons gegenüber den hier verwendeten Tastsymbolen sind daher möglich.

Mobilteil

- 1 Lautsprecher
- 2 Display
- 3 Menütaste "Info" 
- 4 Softkey-Taste rechts
- 5 Aufwärts  /
Wahlwiederholung 
- 6 R-Taste (Flash) 
- 7 Rechts  /
Menü 
- 8 Auflegen-Taste,
Bereitschaftsmodus 
- 9 Zifferntastenblock
- 10 #-Taste / Tastensperre 
- 11 Mikrofon
- 12 *-Taste / Tonruf ausschalten /
Temporäre Tonwahl 
- 13 Gesprächstaste 
- 14 Abwärts  / Anrufliste 
- 15 Links  /
Telefonbuch 
- 16 Freisprechen 
- 17 Softkey-Taste links
- 18 Lautsprecher auf der Rückseite

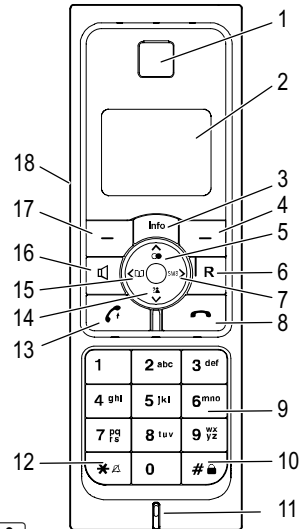

Basisstation (Anrufbeantworter)

- 1 Lautsprecher
- 2 Display
- 3 Mobilteil suchen
(Paging) 
- 4 Lautstärke + 
- 5 Wiedergabe 
- 6 Nächste Nachricht 
- 7 Stopp 
- 8 Lautstärke - 
- 9 Vorherige Nachricht 
- 10 Anrufbeantworter
ein / aus 
- 11 Löschen 
- 12 Ladekontakte
- 13 LED: SMS
- 14 LED: Gesprächsanzeige 
- 15 LED: Power 

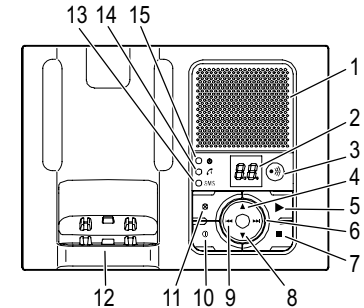















Einführende Informationen





4 Einführende Informationen

















In diesem Kapitel finden Sie grundlegende Informationen zur Handhabung der Bedienungsanleitung und des Telefons.

Darstellungsweise in der Bedienungsanleitung

Darstellung	Beschreibung
	Darstellung von Tasten
	Abgebildete Taste kurz drücken
2 Sek. 	Abgebildete Taste 2 Sekunden drücken
halten 	Abgebildete Taste halten
loslassen 	Abgebildete Taste loslassen
	Nummern oder Buchstaben eingeben
	Mobilteil klingelt
	Basisstation klingelt
	Mobilteil aus der Basisstation nehmen
	Mobilteil in die Basisstation stellen
	Darstellung von Display-Texten
	Darstellung von Display-Symbolen
	Softkey-Taste drücken  Seite 7

Symbole und Texte im Display des Mobilteils

Symbol	Beschreibung
	Konstant: Anzeige der Batteriekapazität. Durchlaufende Segmente: Das Akkupack wird geladen  Seite 6.
	Konstant: Alarmfunktion aktiviert. Blinkend: Alarm.
hh:mm tt/mm	Anzeige der Uhrzeit und des Datums  Seite 20.

	Konstant: Sie führen ein Gespräch. Blinkend: Es erreicht Sie ein Anruf  Seite 10.
	Es sind neue Anrufe in der Anrufliste  Seite 21.
	Anrufbeantworter eingeschaltet.
	Es sind neue Nachrichten auf dem Anrufbeantworter.
	Der Tonruf ist ausgeschaltet  Seite 11.
	Das Freisprechen ist aktiviert  Seite 11.
	Die Tastensperre ist aktiviert  Seite 11.
	Konstant: Sie haben eine neue SMS ¹  Seite 23. Blinkend: SMS-Speicher voll.
	Das Mikrofon ist stummgeschaltet  Seite 11.
	Konstant: Die Verbindung zur Basisstation ist gut. Blinkend: Die Verbindung zur Basisstation bricht ab. Nähern Sie sich der Basisstation.

¹ **SMS: Short Message Service** = Dienst für das Versenden von Kurznachrichten.

Bereitschaftsmodus

Alle Beschreibungen in dieser Bedienungsanleitung gehen davon aus, dass sich das Mobilteil im Bereitschaftsmodus befindet. Den Bereitschaftsmodus erreichen Sie, indem Sie die Taste  drücken.

Energiesparmodus

Nach einiger Zeit im Bereitschaftsmodus wechselt das Mobilteil in einen Energiesparmodus. Das Display ist nun nicht mehr beleuchtet. Drücken Sie eine beliebige Taste, um den Bereitschaftsmodus zu aktivieren.

Navigationstasten



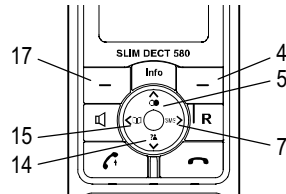





Die Softkey-Tasten (4) und (17) sind in den verschiedenen Menüs mit unterschiedlichen Funktionen belegt. Sie sind in dieser Bedienungsanleitung immer nach den darüber liegenden Texten im Display benannt.



Taste	Im Bereitschaftsmodus	Im Menü
4	- Hauptmenü öffnen	- Angezeigtes Menü öffnen
5	- Wahlwiederholungsliste öffnen	- In den Menüs blättern - Einstellungen ändern
7	- Menü SMS öffnen	- Angezeigtes Menü öffnen - Einstellungen ändern
14	- Anrufliste öffnen	- In den Menüs blättern - Einstellungen ändern
15	- Telefonbuch öffnen	- Eine Ebene zurück - Einstellungen ändern
17	- Intern telefonieren	- Programmier- und Speichervorgänge abbrechen - Eine Ebene zurück

Navigation im Menü











Alle Funktionen sind über unterschiedliche Menüs zu erreichen. Den Weg zur gewünschten Funktion entnehmen Sie der Menüstruktur  Seite 18.

Menu	Hauptmenü öffnen
 oder 	Gewünschtes Untermenü auswählen
OK	Untermenü öffnen
 oder 	Gewünschte Funktion auswählen
OK	Funktion öffnen
 oder 	Gewünschte Einstellung auswählen
	Über Tastenfeld Nummern oder Buchstaben eingeben
OK	Eingaben bestätigen
Zurück	Eine Ebene zurück
	Programmier-/Speichervorgänge abbrechen, Bereitschaftsmodus

 Jeder Vorgang wird automatisch abgebrochen, wenn innerhalb von 30 Sekunden keine Eingabe erfolgt.

Telefonbucheinträge erstellen - Beispiel

Wie Sie in den Menüs navigieren und Eingaben vornehmen, ist hier anhand des Beispiels **Telefonbucheinträge erstellen** erklärt. Verfahren Sie bei allen Einstellungen wie in diesem Beispiel.

	Telefonbuch öffnen
Option	Betätigen
	Wenn noch keine Einträge im Telefonbuch vorhanden sind, wird der Schritt "Option" automatisch übersprungen.
 oder  , OK	Funktion auswählen und bestätigen
 , 	Namen eingeben und weiter
 , 	Rufnummer eingeben und weiter
 oder  , OK	Gruppe auswählen und bestätigen

Telefonieren

5 Telefonieren

Anruf annehmen

,  oder  Anruf annehmen

Gespräch beenden

 oder  Gespräch beenden

Mobilteil aus- und einschalten

Um die Akkus zu schonen, können Sie das Mobilteil ausschalten.

2 Sek. , Ja  Mobilteil ausschalten



4 Sek.  Mobilteil einschalten

Anrufen

 Rufnummer eingeben (max. 24 Ziffern)

Lösche  Bei Falscheingabe letzte Ziffer löschen



 Rufnummer wählen

 Sie können auch zuerst die Gesprächstaste /Freisprechtaste  drücken und erhalten damit das Freizeichen. Die eingegebenen Ziffern Ihrer gewünschten Rufnummer werden sofort gewählt. Eine Korrektur einzelner Ziffern der Rufnummer ist bei dieser Form des Gesprächsaufbaus nicht möglich.

Wahlwiederholung

Ihr Telefon speichert die 20 zuletzt gewählten Rufnummern in einer Wahlwiederholungsliste. Weitere Informationen  Seite 21.

 Wahlwiederholungsliste öffnen



 oder ,  Eintrag auswählen und Verbindung herstellen

D

Eingegangene Anrufe zurückrufen

Ihr Telefon speichert 30 Anrufe in einer Anrufliste  Seite 21.



 Anrufliste öffnen

 oder ,  Eintrag auswählen und Verbindung herstellen

Rufnummern aus dem Telefonbuch wählen

Sie müssen Rufnummern im Telefonbuch gespeichert haben  Seite 9 und 20.

 Telefonbuch öffnen

 oder ,  Eintrag auswählen und Verbindung herstellen

Intern telefonieren¹

Interne Gespräche führen





Sie müssen zwei oder mehr Mobilteile (MT1, MT2, ...) an Ihrer Basisstation angemeldet haben, um interne kostenlose Gespräche führen zu können.

MT1: Intern ,
 oder , OK  Interne Rufnummer des gewünschten Mobilteils wählen

MT2:  Internes Gespräch am anderen Mobilteil annehmen

MT1 / MT2:  Internes Gespräch beenden

Externe Gespräche intern weiterleiten

MT1: Intern ,
 oder , OK  Während des externen Gesprächs interne Rufnummer wählen



MT2:  Internes Gespräch am anderen Mobilteil annehmen

MT1:  Gespräch weiterleiten

¹ Das interne Telefonieren ist nur mit mindestens zwei Mobilteilen möglich  "Verpackungsinhalt prüfen" auf Seite 5.

Rücksprache / Makeln

Während eines externen Gesprächs können Sie ein anderes Mobilteil auswählen, um Rücksprache zu halten. Der externe Gesprächspartner wird gehalten, während Sie mit dem internen Gesprächspartner sprechen. Diesen Vorgang können Sie beliebig oft wiederholen.



MT1: **Intern**,
 oder , **Dir.** Während des externen Gesprächs interne Rufnummer wählen

MT2:  Internes Gespräch am anderen Mobilteil annehmen

MT1: **Makeln** Gesprächspartner wechseln

Konferenzgespräche führen

Ein externes Gespräch kann mit einem weiteren internen Gesprächspartner zum Konferenzgespräch geschaltet werden.

MT1: **Intern**,
 oder , **Dir.** Während des externen Gesprächs interne Rufnummer wählen

MT2:  Internes Gespräch am anderen Mobilteil annehmen

MT1: **Konf** Konferenz starten

MT1: **Einzel** Nur internes Gespräch weiterführen

MT1 / MT2:  Konferenz beenden

Einstellen der Hörerlautstärke

Sie können während eines Gesprächs die Lautstärke in 5 Stufen anpassen.

 oder  Gewünschte Lautstärke auswählen

Anzeige der Gesprächsdauer

Während eines Gesprächs wird die Gesprächsdauer in Stunden, Minuten und Sekunden angezeigt.

Freisprechen

Nutzen Sie diese Funktion, um den Gesprächspartner über den Lautsprecher zu hören.

 Freisprechen einschalten

 Freisprechen ausschalten

Mikrofon im Mobilteil stummschalten

Sie können während eines Telefongesprächs das Mikrofon des Mobilteils aus- und einschalten.

 Mikrofon ausschalten (stummschalten)

 Mikrofon einschalten

Tastensperre

Die Tastensperre verhindert, dass versehentlich Tasten gedrückt werden.

2 Sek.  Tastensperre einschalten

 Bei eingeschalteter Tastensperre können eingehende Anrufe wie gewohnt angenommen werden. Notrufnummern können auch bei eingeschalteter Tastensperre gewählt werden.

2 Sek.  Tastensperre ausschalten

Tonrufmelodie des Mobilteils

Sie können die Tonrufmelodie am Mobilteil ausschalten.

2 Sek.  Tonrufmelodie ausschalten

 Anrufe werden nun über die Basisstation und nicht mehr über das Mobilteil signalisiert.

2 Sek.  Tonrufmelodie einschalten

Mobilteil suchen (Paging)

Wenn Sie Ihr Mobilteil verlegt haben, können Sie es über einen Suchton leicht wiederfinden.

  Suchton starten

 oder  Suchton beenden

6 Telefonbuch / Anrufliste

Telefonbuch

Im Telefonbuch können Sie 200 Rufnummern mit den dazugehörigen Namen speichern.

Namen können maximal 15 Stellen, Rufnummern 24 Ziffern lang sein.

- Geben Sie bei allen Rufnummern immer die Vorwahl mit ein, damit auch eingehende Ortsgespräche einem Telefonbucheintrag zugeordnet werden können.
- Ist die Speicherkapazität erschöpft, zeigt das Display beim nächsten Speichern die Meldung "Telbuch voll". Um wieder Platz zu schaffen, müssen Sie zuerst einen anderen Eintrag löschen.
- Die Telefonbucheinträge sind alphabetisch geordnet. Um direkt zum gewünschten Telefonbucheintrag zu gelangen, drücken Sie den entsprechenden Anfangsbuchstaben.

Namen eingeben

Die Ziffern-Tasten sind mit Buchstaben beschriftet. Durch mehrmaliges Drücken der entsprechenden Taste können Buchstaben, Ziffern und Sonderzeichen eingegeben werden.



Um den gleichen Buchstaben zweimal einzugeben, drücken Sie den entsprechenden Buchstaben. Warten Sie, bis der Cursor eine Stelle weitersprungen ist. Geben Sie den Buchstaben erneut ein.

Wie Sie

- Telefonbucheinträge erstellen,
- Telefonbucheinträge ändern,
- Telefonbucheinträge löschen und
- Schnellwahltasten belegen,

entnehmen Sie der Menüstruktur "Telefonbuch" Seite 20.

Gruppenauswahl

Sie können Ihren Telefonbucheinträgen Gruppen zuweisen, die von Ihnen eingestellte Eigenschaften besitzen.

Wie Sie

- Ihren Einträgen Gruppen zuweisen,
- Gruppennamen ändern und
- Melodien zuweisen,

entnehmen Sie der Menüstruktur "Telefonbuch" Seite 20.

Anrufliste

Insgesamt werden 30 Rufnummern in einer Anrufliste gespeichert.



Die Rufnummernanzeige (**CLIP**¹) ist ein Zusatzdienst Ihres Netzbetreibers. Ihr Telefon zeigt die Rufnummern im Display, wenn Ihr Netzbetreiber diesen Service anbietet. Bitte fragen Sie Ihren Netzbetreiber nach weiteren Informationen.

Wie Sie

- sich Rufnummern aus der Anrufliste anzeigen lassen,
 - Rufnummern aus der Anrufliste im Telefonbuch speichern und
 - Rufnummern aus der Anrufliste löschen,
- entnehmen Sie der Menüstruktur "Anrufliste" Seite 21.

Sonderrufnummern

Zehn für Sie wichtige Rufnummern können gespeichert werden. Die Einträge stehen automatisch an allen Mobilteilen zur Verfügung.

Wie Sie

- sich Einträge anzeigen lassen,
- Einträge ändern und
- Einträge löschen,

entnehmen Sie der Menüstruktur "Sonderrufnummern" Seite 21.

¹ **CLIP**: Calling Line Identification Presentation = Anzeige der Rufnummer eines Anrufers.

7 Anrufbeantworter

Bedienung am Mobilteil



Ihr Anrufbeantworter verfügt über eine gesprochene Bedienungsführung. Beachten Sie diese Anweisungen und Hinweise.

Einstellungsmenü öffnen

Die Einstellungen des Anrufbeantworters nehmen Sie über Ihr Mobilteil vor Seite 18.

Anrufbeantworter ein-/ausschalten

Über das Mobilteil können Sie den Anrufbeantworter ein-/ausschalten Seite 18.

Spracheinstellung

Die Sprachausgabe des Anrufbeantworters ist Englisch und nicht veränderbar.

Datum und Uhrzeit einstellen

Beim Abspielen der Nachrichten werden zu jeder Nachricht der Wochentag und die Uhrzeit ihres Eingangs angesagt. Datum und Uhrzeit einstellen Seite 20.

Maximale Aufnahmezeit

Der Anrufbeantworter speichert bis zu 59 Nachrichten. Die maximale Aufnahmezeit beträgt 15 Minuten. Die Länge für die Nachrichten-Aufnahme ist einstellbar Seite 18. Ist die Speicherkapazität für neue Nachrichten erschöpft, wird kein Anruf mehr aufgezeichnet.

Verzögerung der Anrufannahme

Sie können zwischen 2 bis 8 Tonrufen wählen. Zusätzlich können Sie die Einstellung Spar-Modus für die gebührenfreie Vor-/Fernabfrage verwenden. Mit dieser Vor-/Fernabfrage können Sie gebührenfrei feststellen, ob sich neue Nachrichten auf Ihrem Anrufbeantworter befinden.

- Befinden sich neue Nachrichten auf Ihrem Anrufbeantworter, wird Ihr Anruf spätestens nach 2 Tonrufen angenommen.
- Befinden sich keine neuen Nachrichten auf Ihrem Anrufbeantworter, wird Ihr Anruf erst nach 4 Tonrufen angenommen. Legen Sie vor dem 4. Tonruf auf. So fallen keine Gebühren an.

Weitere Informationen über die Fernabfrage Seite 15.

Mithören eingehender Nachrichten

Sie können eingehende Anrufe mithören, ohne den Anruf anzunehmen.

Ja

Mithören einschalten

Ende

Mithören ausschalten

Anruf übernehmen

Wenn der Anrufbeantworter bereits einen Anruf entgegengenommen hat, können Sie diesen übernehmen. Die Aufzeichnung der Nachricht wird in diesem Fall abgebrochen.



Anruf übernehmen

Ansagemodus wählen

Ihr Anrufbeantworter stellt Ihnen zwei voreingestellte Ansagetexte zur Verfügung. Nach dem Ansagetext "Mit Aufz." kann eine Nachricht hinterlassen werden. Beim Ansagetext "Ohne Aufz." handelt es sich um eine Nur-Ansage, nach der keine Nachricht hinterlassen werden kann. Sie können beide Ansagetexte durch eigene Texte ersetzen. Ist der Speicher des Anrufbeantworters voll, wird automatisch Ansagetext "Ohne Aufz." wiedergegeben. Weitere Informationen Seite 18.

Ansagen aufzeichnen / löschen

Ansagen aufzeichnen

Bevor Sie eine Ansage aufzeichnen, wählen Sie den Ansagemodus (Mit Aufz./Ohne Aufz.), für den Sie eine eigene Ansage aufzeichnen möchten. Die Länge der eigenen Ansage darf bis zu 60 Sekunden betragen.

Eigene Ansage löschen und zur Standardansage zurückkehren

Wenn Sie Ihre eigene Ansage löschen, wird die voreingestellte Standardansage wieder aktiviert. Weitere Informationen Seite 18.

Anrufbeantworter

Nachrichtenmenü öffnen

Menu	Hauptmenü öffnen
^ oder v	
Anrufbeantw., OK	Untermenü auswählen und bestätigen
^ oder v	
Nachr.hören, OK	Nachrichtenmenü auswählen und bestätigen

Tastenfunktionen Nachrichtenmenü

Die folgende Tabelle verschafft Ihnen eine Übersicht über die jeweiligen Funktionen der einzelnen Tasten im Nachrichtenmenü.

Taste	Funktionen
🔊	Wiedergabe über den Lautsprecher
^ oder v	Lautstärke einstellen
Pause	Wiedergabe von Nachrichten pausieren / fortsetzen
4	Nachricht wiederholen
2 x 4	Vorherige Nachricht abhören
5 oder Lösche	Nachricht während der Wiedergabe löschen
6	Nächste Nachricht abhören
☎	Nachrichtenmenü verlassen und in den Bereitschaftsmodus zurückkehren

Aufgezeichnete Nachrichten abhören

Die aufgezeichneten Nachrichten werden in der Reihenfolge wiedergegeben, in der sie eingegangen sind. Der Wochentag und die Uhrzeit werden vor dem Abspielen der jeweiligen Nachricht genannt.

Alle alten Nachrichten löschen

Es werden alle bereits abgehörten Nachrichten gelöscht.

Menu	Hauptmenü öffnen
^ oder v	
Anrufbeantw., OK	Untermenü auswählen und bestätigen
^ oder v	
Nachr.löschen, OK	Funktion auswählen und bestätigen
Ja / Nein	Betätigen

 Gelöschte Nachrichten können nicht wiederhergestellt werden!

Fernabfrage

Sie können Ihren Anrufbeantworter anrufen, um Nachrichten abzuhören und weitere Funktionen durchzuführen. Voraussetzung dafür ist ein Telefon mit Tonwahlfunktion. Die Fernabfrage muss aktiviert sein Seite 18.

PIN-Code für die Fernabfrage

Der PIN-Code ist werkseitig auf "0000" eingestellt. Es wird empfohlen, den werkseitigen PIN-Code "0000" zu ändern. PIN-Code ändern Seite 18.

Fernabfrage starten

	Eigene Rufnummer wählen
,	Während der Ansage betätigen und PIN-Code eingeben

Bei falscher Eingabe hören Sie erneut die Ansage des Anrufbeantworters. Wurde der PIN-Code erneut falsch eingegeben, wird die Verbindung automatisch getrennt.

Jetzt haben Sie die Möglichkeit, weitere Funktionen durchzuführen Tabelle Tastenfunktionen der Fernabfrage.

Ferneinschalten des Anrufbeantworters

	Eigene Rufnummer wählen
	Haben Sie vergessen, Ihren Anrufbeantworter einzuschalten, wird Ihr Anruf erst nach 10 Tonrufen angenommen.
,	Während der Ansage betätigen und PIN-Code eingeben
	Anrufbeantworter ein-/ausschalten

Jetzt haben Sie die Möglichkeit, weitere Funktionen durchzuführen Tabelle Tastenfunktionen der Fernabfrage.

Tastenfunktionen der Fernabfrage

Die Fernabfrage wird automatisch abgebrochen, wenn innerhalb von 8 Sekunden keine Eingabe erfolgt.

Die folgende Tabelle verschafft Ihnen eine Übersicht über die jeweiligen Funktionen der einzelnen Tasten.

Taste	Funktionen
	Hilfsmenü anhören
	Wiedergabe aller Nachrichten starten
	Wiedergabe neuer Nachrichten starten
	Laufende Nachricht wiederholen
2 x	Vorherige Nachricht abhören
	Nachricht während der Wiedergabe löschen
	Nächste Nachricht abhören
	Ansagemodus auswählen: "Mit Aufz." oder "Ohne Aufz."
	Aktuell eingestellten Ansagetext abhören
	Ansagetext "Mit Aufz." oder "Ohne Aufz." aufzeichnen
	Anrufbeantworter ein-/ausschalten
	Aufzeichnung des Ansagetextes beenden
	Das Auflegen beendet die Fernabfrage

Anrufbeantworter

Bedienung an der Basis



Ihr Anrufbeantworter verfügt über eine gesprochene Bedienungsführung. Beachten Sie diese Anweisungen und Hinweise.

Anrufbeantworter ein-/ausschalten



Anrufbeantworter ein-/ausschalten

Lautstärke einstellen

Sie können die Lautstärke in 5 Stufen einstellen.



Lautstärke einstellen

Aufgezeichnete Nachrichten abhören / löschen

Nachrichten abhören

Die aufgezeichneten Nachrichten werden in der Reihenfolge wiedergegeben, in der sie eingegangen sind. Der Wochentag und die Uhrzeit werden vor dem Abspielen der jeweiligen Nachricht genannt.



Nachrichten abhören



Wiedergabe stoppen



Nachricht wiederholen

2 x

Vorherige Nachricht



Nächste Nachricht

Eine Nachricht löschen



Zu löschende Nachricht abhören



Während der Wiedergabe löschen

Alle Nachrichten löschen

Es werden alle bereits abgehörten Nachrichten gelöscht.



Löschvorgang starten



Nachrichten löschen

Anrufbeantworterdisplay

Das Display des Anrufbeantworters zeigt den Status des Geräts an.

-- Anrufbeantworter ausgeschaltet

0-59 Anrufbeantworter eingeschaltet,
Anzahl gespeicherter Nachrichten



Wenn neue Nachrichten vorhanden sind, blinkt die Anzeige der gespeicherten Nachrichten.

rA Erscheint, wenn ein Mobilteil
Einstellungen am Anrufbeantworter
vornimmt.

rE Erscheint, wenn eine Nachricht
aufgezeichnet wird.

8 Nebenstellenanlagen / Zusatzdienste

R-Taste an Nebenstellenanlagen

Ist Ihr Telefon an einer Nebenstellenanlage angeschlossen, können Sie über die **R-Taste** Funktionen, wie z. B. Anrufe weiterleiten und automatischen Rückruf, nutzen. Lesen Sie bitte in der Bedienungsanleitung Ihrer Nebenstellenanlage, welche Flash-Zeit Sie zur Nutzung dieser Funktionen einstellen müssen. Ob Ihr Telefon an Ihrer Nebenstellenanlage einwandfrei funktioniert, erfahren Sie bei dem Händler, bei dem die Anlage gekauft wurde. Die Flash-Zeit stellen Sie über das Menü ein. Auf Seite 19 finden Sie die Position im Menü.

Amtskennziffer

Bei Nebenstellenanlagen ist es erforderlich, eine bestimmte Nummer zu wählen, um ein Freizeichen für eine Amtsleitung zu bekommen. Diese Amtskennziffer können Sie speichern. Wenn Ihr Telefon diese Amtskennziffer vor einer eingegebenen Rufnummer erkennt, wird **automatisch** nach der Amtskennziffer eine **Wahlpause** eingefügt. Einstellen der Amtskennziffer  Seite 19.

Wahlpause manuell eingeben

Sie können nach der Amtskennziffer **manuell** eine **Wahlpause** einfügen, um direkt weiterwählen zu können, ohne das Freizeichen abzuwarten.

2 Sek. Wahlpause einfügen

Nach der Amtskennziffer erfolgt die Wahl der eigentlichen Rufnummer nach einer bestimmten Zeit.



Die Wahlpause kann auch bei der Eingabe von Rufnummern im Telefonbuch [Rufnummernspeicher] gespeichert werden.

R-Taste und Zusatzdienste

Ihr Telefon unterstützt Zusatzdienste Ihres Netzbetreibers, wie z. B. Makeln, Anklopfen und Konferenz. Über die **R-Taste** können Sie diese Zusatzdienste nutzen. Bitte fragen Sie Ihren Netzbetreiber, welche Flash-Zeit Sie zur Nutzung von Zusatzdiensten einstellen müssen. Zur Freischaltung von Zusatzdiensten wenden Sie sich bitte an Ihren Netzbetreiber. Die Flash-Zeit stellen Sie über das Menü ein. Auf Seite 19 finden Sie die Position im Menü.

Rufnummernanzeige (CLIP¹)



Die Rufnummernanzeige ist ein Zusatzdienst Ihres Netzbetreibers. Fragen Sie Ihren Netzbetreiber nach weiteren Informationen.

Wenn diese Funktion an Ihrer Telefonleitung zur Verfügung steht, wird Ihnen bereits die Rufnummer des Anrufers angezeigt, wenn das Telefon klingelt. Hat der Anrufer das Übertragen seiner Rufnummer unterdrückt, wird eine entsprechende Meldung angezeigt. Die Rufnummer kann nicht angezeigt und somit auch nicht in der Anrufliste gespeichert werden.

Anrufbeantworter im Telefonnetz

Der Anrufbeantworter im Telefonnetz ist ein Zusatzdienst vieler Netzbetreiber. Wenn Ihr Netzbetreiber einen Anrufbeantworter im Telefonnetz für Sie bereitstellt, werden Sie mit einem Symbol über neue Nachrichten informiert (**VMWI**²). Über diese Funktion können Sie nur dann verfügen, wenn Ihr Netzbetreiber diesen Zusatzdienst anbietet. Bitte fragen Sie Ihren Netzbetreiber nach weiteren Informationen.

Wenn Sie den Zusatzdienst aktiviert haben und neue Nachrichten auf Ihrem Anrufbeantworter im Telefonnetz vorhanden sind, können Sie manuell über das Menü die Visualisierung ausschalten, ohne die Nachricht abzuhören. Auf Seite 19 finden Sie die Position im Menü.

Msg Wait aus

OK

Visualisierung ausschalten

¹ **CLIP**: Calling Line Identification Presentation = Anzeige der Rufnummer eines Anrufers.

² **VMWI**: Visual Message Waiting Indication = Optische Anzeige neuer Nachrichten.

Menüstruktur

9 Menüstruktur

Hauptmenü

In das Hauptmenü gelangen Sie durch Drücken der Softkey-Taste

Menu . Wie Sie sich im Menü bewegen und Eingaben vornehmen, zeigt Ihnen Seite 9.

SMS¹

SMS schreiben		Option	Senden	Nummer eing.	Senden
				Option	Telefonbuch
					Wahlwiederh.
					Anrufliste
			Speichern		
			Vorlage		
Eingangsliste ²					
Ausgangsliste					
Vorlage					
Einstellungen	SMS-Center			SMS-Center 1 - 4	
	SMS-Sendecent.			SMS-Center1/2	
	SMS-Alarm			Ein/Aus	

Anrufbeantw.

Nachr.hören		
Nachr.löschen		
Anruhf.ein/aus	Ein/Aus	
Ansagetexte	Neue Ansage	Mit Aufz./Ohne Aufz.
	Ansage hören	Mit Aufz./Ohne Aufz.
Einstellungen	AB-Modus	Mit Aufz./Ohne Aufz.
	Verzögerung	Spar-Modus
		2 Rufe - 8 Rufe
	Aufnahmezeit	30s - 180s
	Mithören	Ein/Aus
Fernabfrage	Aus	
	Ein	Alte PIN eing. ➔
		➔ Neue PIN eing. ➔
		➔ Wiederhole PIN



¹ Weitere Informationen zu SMS-Textnachrichten  Seite 23.

² Es können bis zu 30 Nachrichten gespeichert werden.





Audio

Tonruf	Extern	Melodie 1 - 15
	Intern	Melodie 1 - 15
	Tonruf-Lautst.	Aus, 1 - 5
	Ruhe	Aus/Beep
Hinweistöne	Tastenton	Ein/Aus
	Quittungston	Ein/Aus
	Akku leer	Ein/Aus
	Ausser Reichwe	Ein/Aus

Einstellungen

MT-Einstellung	Direktruf	System PIN ¹	Aus
			Ein 
	Wähle Basis	Basis 1 - 4	
	Display	Kontrast 1 - 8	
		Mobilteil-Name 	
	Sprache	Deutsch/English/ Italiano/Français	
	Direktannahme	Ein/Aus	
	MT anmelden	Basis 1 - 4	System PIN
	MT abmelden	System PIN	
	MT-Reset	Ja/Nein	

¹ Der System-PIN ist werkseitig auf "0000" eingestellt.

Basis einst.	Tonruf	Tonruf-Melodie	Melodie 1 - 5
		Tonruf-Lautst.	Aus, 1 - 5
	MT-Priorität ²	Alle Mobil.	
		MT auswählen	Mobilteil 1 - 5 
			 2/4/6/8
	Wahlverfahren	Tonwahl/Impulswahl	
	Flash-Zeit	80ms - 800ms	
	Msg Wait aus		
	System PIN	Alte PIN eing.	Neue PIN eing. 
			 Wiederhole PIN
	Amtskennziffer 		
ECO Mode	Ein/Aus		
System Reset ³	PIN eingeben	Ja/Nein	

² Hier können Sie einstellen, ob bei einem eingehenden Anruf alle angemeldeten Mobilteile klingeln sollen oder ob vorrangig zunächst nur ein bestimmtes Mobilteil klingeln soll.

³ **Achtung:** Alle vorhandenen Nachrichten, auch neue/nicht abgehörte Nachrichten, werden bei einem System-Reset gelöscht!

Menüstruktur

☐	Zeit / Alarm	Datum/Zeit	Zeitformat	12 Std/24 Std
			Datumsformat	mm/tt oder tt/mm
			Zeit eingeben	
			Datum eingeben	
	Alarm		Zeit eingeben	
			Alarm ein/aus	Aus
			Einmal	
			Täglich	
			Tonruf-Melodie	Melodie 1 - 15

Telefonbuch

☐	ggf. ☐/☐	gewünschten Eintrag auswählen		
Option	Neuer Eintrag	Name	☐	☐
		Nummer	☐	☐
		Gruppenauswahl	Keine	
			Familie	
			Geschäft	
			Freunde	
			Dienste	
			VIP	
			Andere	
			Allgemein	

☐	Eintrag ändern	Name	☐	☐
		Nummer	☐	☐
		Gruppenauswahl	Keine	
			Familie	
			Geschäft	
			Freunde	
			Dienste	
			VIP	
			Andere	
			Allgemein	
	Ansehen	Name	☐	
		Nummer	☐	
		Gruppenmelodie		
	Kopieren	Mobilteil 1, 2, ..		
	Alle kopieren	Mobilteil 1, 2, ..		
	Lösche Eintrag	Ja/Nein		
	Alle löschen	Ja/Nein		
	Speicherbeleg.			
	Gruppe ändern	Gruppe wählen	Gr.umbenennen	
			Tonruf-Melodie	
	Schnellwahl	Taste 2 - 9	Eintrag wählen	



Wenn die Schnellwahltaste bereits belegt ist, wird der Eintrag angezeigt.

Sonderrufnummern

Info	ggf. <input type="button" value="^"/> / <input type="button" value="v"/> gewünschten Eintrag auswählen	
Option	Ansehen	Name
		Nummer
	Lösche Eintrag	
	Eintrag ändern	Name <input type="button" value="M"/> <input type="button" value="v"/>
		Nummer <input type="button" value="M"/>
	Alle löschen	Ja/Nein

Anrufliste

?	ggf. <input type="button" value="^"/> / <input type="button" value="v"/> gewünschten Eintrag auswählen	
Option	Ansehen	
	Lösche	
	Alle löschen	Ja/Nein
	Nr.anrufen	Option Telefonbuch
		Wahlwiederh.
		Anrufliste
	Nr.speichern	siehe Neuer Eintrag
	Einstellungen	Anrufart Alle Anrufe
		Unbeantw.
	Anrufl.-Alarm	Ein/Aus

SMS

siehe SMS Seite 18.

Wahlwiederholung

<input checked="" type="radio"/>	ggf. <input type="button" value="^"/> / <input type="button" value="v"/> gewünschten Eintrag auswählen	
Option	Lösche	Ja/Nein
	Alle löschen	Ja/Nein
	Nr.anrufen	Option Telefonbuch
		Wahlwiederh.
		Anrufliste
	Nr.speichern	siehe Neuer Eintrag

Besondere Funktionen

10 Besondere Funktionen

Wahlverfahren

Sie können Ihr Telefon sowohl an den analogen Vermittlungsstellen (Impuls-Wahlverfahren) als auch an den neuen digitalen Vermittlungsstellen (Ton-Wahlverfahren) betreiben. Das Wahlverfahren wird über das Menü eingestellt. Auf Seite 19 finden Sie die Position im Menü.

Temporäre Tonwahl

Können Sie Ihr Telefon nur mit dem Impuls-Wahlverfahren betreiben, brauchen Sie nicht auf die Vorteile des Ton-Wahlverfahrens (z. B.: Abfrage eines Anrufbeantworters im Telefonnetz) zu verzichten. Während einer bestehenden Verbindung können Sie vorübergehend zum Ton-Wahlverfahren wechseln.

2 Sek. Während des Gesprächs drücken

Nach Gesprächsende wird wieder automatisch auf das Impuls-Wahlverfahren zurückgeschaltet.

Alarm

Mit dieser Funktion können Sie sich zu einer bestimmten Zeit von Ihrem Mobilteil alarmieren lassen. Auf Seite 20 finden Sie die Position im Menü.

Direktruf

Mit dieser Funktion haben Sie die Möglichkeit, eine bestimmte Rufnummer zu speichern, die bei Betätigen einer beliebigen Taste (außer) automatisch angerufen wird. Auf Seite 19 finden Sie die Position im Menü.

Schnellwahl

Sie müssen Rufnummern als Schnellwahlnummer gespeichert haben. Auf Seite 20 finden Sie die Position im Menü.

2 Sek. bis Gewünschte Schnellwahl Taste drücken

Die hinterlegte Rufnummer wird direkt gewählt.

Telefonbucheinträge kopieren

Sie können Telefonbucheinträge von einem Mobilteil auf ein anderes kopieren.

Einzelnen Eintrag kopieren

<input type="button" value="☰"/>	Telefonbuch öffnen
<input type="button" value="↑"/> /↓	Gewünschten Eintrag auswählen
<input type="button" value="Option"/>	Option aufrufen
<input type="button" value="↑"/> /↓, <input type="button" value="OK"/>	Kopieren auswählen und bestätigen
<input type="button" value="←"/> /→, <input type="button" value="OK"/>	Mobilteil auswählen und bestätigen
<input type="button" value="Ja"/> / <input type="button" value="Nein"/>	Am Empfänger-Mobilteil auswählen

Alle Einträge kopieren

<input type="button" value="☰"/>	Telefonbuch öffnen
<input type="button" value="Option"/>	Option aufrufen
<input type="button" value="↑"/> /↓, <input type="button" value="OK"/>	Alle kopieren auswählen und bestätigen
<input type="button" value="←"/> /→, <input type="button" value="OK"/>	Mobilteil auswählen und bestätigen
<input type="button" value="Ja"/> / <input type="button" value="Nein"/>	Am Empfänger-Mobilteil auswählen

11 SMS

SMS-Voraussetzungen

Ihr Telefonanschluss muss über das Leistungsmerkmal **CLIP**¹ verfügen. Vergewissern Sie sich bei Ihrem Netzbetreiber, dass dieses Leistungsmerkmal für Ihren Telefonanschluss freigeschaltet ist. Um den **SMS**²-Dienst zu nutzen, muss dieser von Ihrem Netzbetreiber aktiviert werden.

- Nicht von jeder Nebenstellenanlage können SMS versandt werden.



Wenn Sie von einer Nebenstellenanlage SMS versenden möchten, speichern Sie vor den Service-Center-Nummern in Ihrem Mobilteil die Amtskennziffer Ihrer Nebenstellenanlage ein.

- Bei Call-by-Call-Verbindungen ist der SMS-Versand derzeit nicht möglich.
- Das Senden von SMS-Nachrichten ist kostenpflichtig.
- Nutzt der Empfänger im Festnetz keinen SMS-Dienst oder kann sein Telefon generell keine SMS empfangen, wird die SMS automatisch als Sprachmeldung zugestellt.
- Die Kostenberechnung erfolgt über Ihren Netzbetreiber.

SMS-Service-Center

Die Verteilung von SMS-Nachrichten erfolgt über ein Service-Center. Wenn Sie SMS-Textnachrichten versenden möchten, müssen Sie eine Service-Center-Nummer in Ihr Mobilteil einprogrammieren  Seite 18. Bitte erfragen Sie beim Anbieter Ihrer Wahl die erforderliche Service-Center-Nummer und die Vorgehensweise zur Freischaltung des SMS-Dienstes.



Ihr Telefon ist zum Versenden von SMS-Textnachrichten vorbereitet. Es sind bereits SMS-Center-Nummern in Ihrem Mobilteil einprogrammiert. Aktivieren Sie das gewünschte SMS-Center im SMS-Menü  Seite 18.

¹ **CLIP**: Calling Line Identification Presentation = Anzeige der Rufnummer eines Anrufers.

² **SMS**: Short Message Service = Dienst für das Versenden von Kurznachrichten.

SMS-Center 1	SMS-Center 2
Swisscom: 0622100000	Cablecom: 0435375370

Text eingeben

Zur Eingabe von Text sind die Ziffern-Tasten mit Buchstaben beschriftet. Durch mehrmaliges Drücken der entsprechenden Taste können Buchstaben, Ziffern und Sonderzeichen eingegeben werden. Die Navigation, wie Sie eine SMS schreiben können, entnehmen Sie der Menüstruktur

 Seite 18.



Zwischen Groß- und Kleinschreibung umschalten

Lösche

Letzte Stelle löschen

halten Lösche

Alles Löschen

SMS-Textvorlagen

Es stehen 5 vorprogrammierte Textvorlagen zur Verfügung  Seite 18.

SMS-Hinweissignal (Alarm)

Wenn Sie neue SMS-Textnachrichten empfangen haben, werden Sie mit einem Hinweissignal darauf aufmerksam gemacht. Das Signal wird über das Menü aktiviert oder deaktiviert. Auf Seite 18 finden Sie die Position im Menü.

Erweitern des Telefonsystems

12 Erweitern des Telefonsystems

Über den international genormten **GAP**¹-Standard ist die Kompatibilität von Mobilteilen und Basisstationen unterschiedlicher Hersteller geregelt. So ist es möglich, SWITEL-Geräte und Geräte anderer Hersteller zusammen in ein Telefonsystem zu integrieren. Es ist jedoch möglich, dass einige Funktionen nicht zur Verfügung stehen.

Mehrere Mobilteile

Sie können insgesamt 5 Mobilteile an Ihre Basisstation anmelden.

Anmelden von Mobilteilen

Bevor Sie ein Mobilteil anmelden, müssen Sie die Basisstation in den Registriermodus setzen.

halten  bis  blinkt Registriermodus gestartet

Melden Sie nun das Mobilteil an  Seite 19. Benutzen Sie zur Anmeldung den aktuell eingestellten PIN-Code  Seite 19.

Nach dem Anmelden wird dem Mobilteil eine interne Rufnummer gegeben. Diese interne Rufnummer wird im Display angezeigt.

 Um Mobilteile anderer Hersteller anzumelden, lesen Sie bitte deren Bedienungsanleitungen.

Abmelden von Mobilteilen

 Jedes Mobilteil kann sich selbst oder andere an dieser Basisstation angemeldete Mobilteile abmelden. Im Display des abgemeldeten Mobilteils erscheint dann die Meldung MT anmelden!



Mobilteile werden über das Menü abgemeldet. Auf Seite 19 finden Sie die Position im Menü.

Mehrere Basisstationen

Sie können die Reichweite Ihres Mobilteils vergrößern, wenn Sie es an mehrere Basisstationen anmelden. Es kann gleichzeitig an 4 verschiedenen Basisstationen angemeldet sein. Jede Basisstation benötigt eine eigene Telefonsteckdose. Es können Anschlüsse mit derselben und auch mit unterschiedlichen Rufnummern sein.

Auswahl der Basis  Seite 19.

 Laufende Gespräche können nicht von einer zur anderen Basisstation übertragen werden.

 Bei Bedarf können Sie die Reichweite des Telefonsystems erhöhen, indem Sie den ECO-Mode ausschalten  Seite 19 (ECO Mode → Aus).

¹ **GAP: Generic Access Profile** = Standard für das Zusammenwirken von Mobilteilen und Basisstationen unterschiedlicher Hersteller.

13 Falls es Probleme gibt

Service-Hotline

Haben Sie Probleme mit Ihrem Telefon, kontrollieren Sie zuerst die folgenden Hinweise. Bei technischen Problemen können Sie sich an unsere Service-Hotline unter Tel. 0900 00 1675 innerhalb der Schweiz (Kosten Swisscom bei Drucklegung: CHF 2.00/min) wenden. Bei Garantieansprüchen wenden Sie sich an Ihren Fachhändler. Die Garantiezeit beträgt 2 Jahre.

Fragen und Antworten

Fragen	Antworten
Keine Verbindung zur Basisstation möglich	<ul style="list-style-type: none"> - Prüfen Sie, ob Sie sich mit dem richtigen PIN-Code an der Basisstation angemeldet haben ☞ Seite 19.
Kein Telefongespräch möglich	<ul style="list-style-type: none"> - Das Telefon ist nicht korrekt angeschlossen oder gestört. Verwenden Sie nur das mitgelieferte Telefonanschlusskabel. - Testen Sie mit einem anderen Telefon, ob Ihr Telefonanschluss in Ordnung ist. - Das Netzteil ist nicht eingesteckt oder es liegt ein totaler Stromausfall vor. - Das aufladbare Akkupack ist leer oder defekt. - Sie haben sich zu weit von der Basisstation entfernt. - Wahlverfahren falsch eingestellt ☞ Seite 19.
Verbindung abgehackt, fällt aus	<ul style="list-style-type: none"> - Sie haben sich zu weit von der Basisstation entfernt. - Falscher Aufstellungsort der Basisstation.

Das System reagiert nicht mehr	<ul style="list-style-type: none"> - Setzen Sie alle Funktionen in den Werkszustand zurück ☞ Seite 19. - Ziehen Sie kurzzeitig das Netzteil aus der Steckdose.
Das Akkupack ist in kürzester Zeit leer	<ul style="list-style-type: none"> - Das Akkupack ist leer oder defekt. - Stellen Sie das Mobilteil richtig auf die Basisstation. Reinigen Sie die Kontaktflächen am Mobilteil und an der Basisstation mit einem weichen trockenen Tuch. - Stellen Sie das Mobilteil für 20 Stunden in die Basisstation.
Die Rufnummernanzeige (CLIP ¹) funktioniert nicht	<ul style="list-style-type: none"> - Die Rufnummernanzeige ist ein Zusatzdienst Ihres Netzbetreibers. Bitte fragen Sie Ihren Netzbetreiber nach weiteren Informationen. - Der Anrufer hat das Übertragen seiner Rufnummer unterdrückt.
Der Anrufbeantworter nimmt keine Nachrichten auf	<ul style="list-style-type: none"> - Stellen Sie sicher, dass der Anrufbeantworter korrekt angeschlossen und eingeschaltet ist. - Prüfen Sie, ob der Speicher des Anrufbeantworters voll ist. Löschen Sie ggf. Nachrichten aus dem Speicher ☞ Seite 18.
Sie können keine Fernabfrage durchführen	<ul style="list-style-type: none"> - Prüfen Sie, ob Sie den richtigen Sicherheitscode für die Fernabfrage benutzen ☞ Seite 18. - Das Telefon, das Sie für die Fernabfrage nutzen, muss auf Ton-Wahlverfahren eingestellt sein.

¹ CLIP: Calling Line Identification Presentation = Anzeige der Rufnummer eines Anrufers.

Technische Eigenschaften

14 Technische Eigenschaften

Technische Daten

Merkmal	Wert
Standard	DECT¹-GAP²
Stromversorgung (Basisstation)	Eingang: 220/230 V, 50 Hz Ausgang: 6 V, 600 mA
Stromversorgung (Ladestation)	Eingang: 220/230 V, 50 Hz Ausgang: 6 V, 300 mA
Reichweite	Außen: ca. 300 m Innen: ca. 50 m
Bereitschaft	Bis zu 100 h
Max. Gesprächsdauer	Bis zu 10 h
Aufladbares Akkupack	NiMH 2.4 V 600mAh
Wahlverfahren	Tonwahl (DTMF) Impulswahl (IWW)
Zulässige Umgebungstemperatur	10 °C bis 30 °C
Zulässige relative Luftfeuchtigkeit	20 % bis 75 %
Flash-Funktion	80, 100, 120, 180, 250, 300, 600 oder 800 ms

¹ **DECT**: Digital Enhanced Cordless Telecommunication = Standard für kabellose Telefone.

² **GAP**: Generic Access Profile = Standard für das Zusammenwirken von Mobilteilen und Basisstationen unterschiedlicher Hersteller.

Werkseinstellungen

Mobilteil

Die Werkseinstellungen werden über das Menü wiederhergestellt. Auf Seite 19 finden Sie die Position im Menü.

Tonruf-Lautst.	5	Tastenton	Ein
Interne Melodie	1	Lautsprecherlautstärke	3
Externe Melodie	2	Wahlwiederh.	Leer
Akku leer	Ein	Hörerlautstärke	3
Ausser Reichwe	Ein	Sprache	Deutsch

Basisstation

Die Werkseinstellungen werden über das Menü wiederhergestellt. Auf Seite 19 finden Sie die Position im Menü.



Achtung: Alle vorhandenen Nachrichten, auch neue/nicht abgehörte Nachrichten, werden bei einem System Reset gelöscht!

System PIN	0000	Flash-Zeit	100 ms
Wahlverfahren	Tonwahl	Tonruf-Melodie	1
Amtskennziffer	Leer	Tonruf-Lautst.	3
Anrufliste	Leer	ECO Mode	Ein

Anrufbeantworter

Anrufbeantw.	Ein	Aufnahmezeit	60 s
Ansagetexte	Mit Aufz.	Mithören	Ein
Verzögerung	Spar-Modus	Fernabfrage	Ein

Konformitätserklärung

Dieses Gerät erfüllt die Anforderungen der EU-Richtlinie: 1999/5/EG Richtlinie über Funkanlagen und Telekommunikationsendeinrichtungen und die gegenseitige Anerkennung ihrer Konformität. Die Konformität mit der o. a. Richtlinie wird durch das CE-Zeichen auf dem Gerät bestätigt.



Für die komplette Konformitätserklärung nutzen Sie bitte den kostenlosen Download von unserer Website www.switel.com.

Pflegehinweise / Garantie

15 Pflegehinweise / Garantie

Pflegehinweise

- Reinigen Sie die Gehäuseoberflächen mit einem weichen und fusselfreien Tuch.
- Verwenden Sie keine Reinigungs- oder Lösungsmittel.

Garantie

SWITEL - Geräte werden nach den modernsten Produktionsverfahren hergestellt und geprüft. Ausgesuchte Materialien und hoch entwickelte Technologien sorgen für einwandfreie Funktion und lange Lebensdauer. Ein Garantiefall liegt nicht vor, wenn die Ursache einer Fehlfunktion des Gerätes bei dem Telefonnetzbetreiber oder einer eventuell zwischengeschalteten Nebenstellenanlage liegt. Die Garantie gilt nicht für die in den Produkten verwendeten Batterien, Akkus oder Akkupacks. Die Garantiezeit beträgt 24 Monate, gerechnet vom Tage des Kaufs.

Innerhalb der Garantiezeit werden alle Mängel, die auf Material- oder Herstellungsfehler zurückzuführen sind, kostenlos beseitigt. Der Garantieanspruch erlischt bei Eingriffen durch den Käufer oder durch Dritte. Schäden, die durch unsachgemäße Behandlung oder Bedienung, natürliche Abnutzung, durch falsches Aufstellen oder Aufbewahren, durch unsachgemäßen Anschluss oder Installation sowie durch höhere Gewalt oder sonstige äußere Einflüsse entstehen, fallen nicht unter die Garantieleistung. Wir behalten uns vor, bei Reklamationen die defekten Teile auszubessern, zu ersetzen oder das Gerät auszutauschen. Ausgetauschte Teile oder ausgetauschte Geräte gehen in unser Eigentum über. Schadenersatzansprüche sind ausgeschlossen, soweit sie nicht auf Vorsatz oder grober Fahrlässigkeit des Herstellers beruhen.

Sollte Ihr Gerät dennoch einen Defekt innerhalb der Garantiezeit aufweisen, wenden Sie sich bitte unter Vorlage Ihrer Kaufquittung ausschließlich an das Geschäft, in dem Sie Ihr SWITEL - Gerät gekauft haben. Alle Gewährleistungsansprüche nach diesen Bestimmungen sind ausschließlich gegenüber Ihrem Fachhändler geltend zu machen. Nach Ablauf von zwei Jahren nach Kauf und Übergabe unserer Produkte können Gewährleistungsrechte nicht mehr geltend gemacht werden.

16 Stichwortverzeichnis

A

Abhören, 16
 Abmelden, 24
 Abnehmen, 10
 Akkuladezustand, 6
 Akkupack einlegen, 6
 Alarm, 22
 Amtskennziffer, 17
 Ändern, 12
 Anmelden, 24
 Anrufannahme, 6, 10
 Anrufbeantworter, 13
 Anrufbeantworter im Telefonnetz, 17
 Anrufen, 10
 Anrufliste, 12
 Anrufübernahme, 13
 Ansagemodus, 13
 Ansagen, 13
 Aufladen, 6
 Auflegen, 10
 Aufzeichnen, 13
 Ausschalten, 10, 13, 16

B

Basisstation, 5, 7, 24
 Bedienelemente, 7
 Bedienung, 8
 Bedienung am Mobilteil, 13
 Bedienung an der Basis, 16
 Bereitschaftsmodus, 9

C

CLIP, 17

D

Datum, 6
 Direktannahme, 6
 Direktruf, 22
 Display, 8, 16
 Displaysprache, 6
 Displaysymbole, 8

E

ECO-Mode, 6
 Einschalten, 10, 13, 16
 Einstellungs Menü, 13
 Energiesparmodus, 9
 Erstellen, 9, 12
 Erweiterung, 24

F

Fehlerbehebung, 25
 Fernabfrage, 15
 Fern einschalten, 15
 Fragen und Antworten, 25
 Freisprechen, 11
 Funktionen, 22

G

Garantie, 28
 Gebührensparer, 13
 Gespräch beenden, 10
 Gesprächsdauer, 11
 Gesprächsweiterleitung, 10
 Gruppenauswahl, 12
 Gruppennamen, 12

H

Hauptmenü, 18
 Hinweissignal, 23
 Hörerlautstärke, 11

I

Impuls-Wahlverfahren, 22
 Inbetriebnahme, 5
 Info, 21
 Interngespräche, 10

K

Konferenzgespräche, 11
 Konformitätserklärung, 27

L

Ladestation, 5
 Lautstärke, 16
 Löschen, 12, 13, 14, 16

M

Makeln, 11
 Maximale Aufnahmezeit, 13
 Melodie, 12
 Menüstruktur, 18
 Mikrofonstummuschaltung, 11
 Mithören, 13
 Mobilteil, 7, 24

N

Nachrichten, 16
 Nachrichten abhören, 14
 Nachrichten löschen, 16
 Nachrichtenmenü, 14
 Namenseingabe, 12
 Navigationstasten, 9
 Nebenstellenanlagen, 17

P

Paging, 11
 Pflegehinweise, 28
 PIN-Code, 15
 Probleme, 25

R

R-Taste, 17
 Rückruf, 10
 Rücksprache, 11
 Rufnummernanzeige, 12, 17

S

Schnellwahl, 12, 22
 Schreibweisen, 8
 Service-Center, 23
 Service-Hotline, 25
 Sicherheitshinweise, 4
 SMS, 23
 SMS-Textvorlagen, 23
 Sonderrufnummern, 12
 Speichern, 9, 12
 Sprache, 13
 Strahlungsreduzierung, 6
 Stummschaltung, 11
 Suchen, 11
 Symbole, 8

T

Tastenfunktionen, 14, 15
 Tastensperre, 11
 Technische Daten, 26
 Telefonbuch, 10, 12, 20, 21
 Telefonbucheinträge, 9, 12
 Telefonbucheinträge kopieren, 22
 Telefonieren, 10
 Temporäre Tonwahl, 22
 Texteingabe, 12, 23
 Ton-Wahlverfahren, 22
 Tonrufmelodie, 11

U

Uhrzeit, 6, 13

Stichwortverzeichnis

V

Verpackungsinhalt, 5

Verzögerung, 13

VMWI, 17

W

Wählen, 10

Wahlpause automatisch, 17

Wahlpause manuell eingeben, 17

Wahlverfahren, 22

Wahlwiederholung, 10, 21

Weiterleitung, 10

Werkseinstellungen, 26

Wochentag, 6, 13

Z

Zusatzdienste, 17

1	Consignes de sécurité	32
2	Mettre votre téléphone en service	33
3	Éléments de manipulation	35
4	Introduction	36
5	Téléphoner	39
6	Répertoire/Liste d'appels	41
7	Répondeur	42
8	Installations à postes supplémentaires / services confort	46
9	Structure du menu	47
10	Fonctions particulières	51
11	SMS	52
12	Élargissement du système téléphonique	53
13	En cas de problèmes	54
14	Caractéristiques techniques	55
15	Remarques d'entretien / Garantie	57
16	Index	58

Consignes de sécurité

1 Consignes de sécurité

Lisez très attentivement ce mode d'emploi.

Utilisation conforme aux prescriptions

Ce téléphone convient pour téléphoner à l'intérieur d'un réseau téléphonique. Tout autre utilisation est considérée comme non conforme à l'usage. Des modifications ou changements effectués d'un propre gré ne sont pas autorisés. N'ouvrez en aucun cas l'appareil et n'effectuez aucun essai de réparation vous-même.

Lieu d'installation

Évitez toute nuisance par la fumée, la poussière, les vibrations, les produits chimiques, l'humidité, la grande chaleur ou l'ensoleillement direct. Ne vous servez pas du combiné dans des endroits exposés aux explosions.

Bloc secteur



Attention : N'utilisez que le bloc secteur fourni avec l'appareil, d'autres pouvant endommager votre téléphone. Vous ne devez pas bloquer l'accès au bloc secteur par des meubles ou d'autres objets.

Pack de piles rechargeables



Attention : Ne jetez pas les piles rechargeables dans le feu. N'utilisez que des piles rechargeables du même type ! Veillez à une polarisation correcte ! Risque d'explosion lors de leur chargement si la polarisation est incorrecte.

Panne de courant

En cas de panne de courant, vous ne pouvez pas téléphoner avec le téléphone. Tenez à votre disposition, pour parer à de telles situations, un téléphone filaire fonctionnant sans alimentation externe en courant.

Appareils médicaux



Attention : N'utilisez pas ce téléphone à proximité d'appareils médicaux. Leur influence ne peut pas être entièrement exclue.

Les téléphones **DECT**¹ peuvent causer un bourdonnement désagréable dans les prothèses auditives.

Élimination

Si vous ne voulez plus vous servir de votre appareil, veuillez l'apporter au centre de collecte de l'organisme d'élimination des déchets de votre commune (par ex. centre de recyclage). L'icône ci-contre signifie que vous ne devez en aucun cas jeter votre appareil dans les ordures ménagères ! D'après la loi relative aux appareils électriques et électroniques, les propriétaires d'appareils usagés sont tenus de mettre tous les **appareils électriques et électroniques** usagés dans un collecteur séparé.

Éliminez les piles rechargeables auprès d'un revendeur de piles ainsi que dans des centres de collecte compétents qui tiennent à votre disposition les collecteurs appropriés correspondants.

Éliminez les **fournitures d'emballage** conformément au règlement local.



¹ **DECT** : Digital Enhanced Cordless Telecommunication = Standard pour les téléphones sans fil.

2 Mettre votre téléphone en service

Remarques concernant la sécurité



Attention : Avant de mettre votre appareil en service, lisez impérativement les consignes de sécurité mentionnées au chapitre 1.

Contrôler le contenu de l'emballage

Les éléments suivants font partie de la livraison :

Contenu	Modèle DFT 817x			
	8171	8172 ¹	8173 ¹	8174 ¹
Base (répondeur) avec bloc d'alimentation	1	1	1	1
Chargeur avec bloc d'alimentation	-	1	2	3
Combiné	1	2	3	4
Câble de raccordement téléphonique	1	1	1	1
Pack de piles rechargeables	1	2	3	4
Mode d'emploi	1	1	1	1

¹ À l'adresse www.switel.com, vous apprendrez si ce kit téléphonique est déjà disponible à la vente.

Raccorder la base



Attention : Posez la base à une distance minimum d'1 m par rapport à d'autres appareils électroniques, une distance inférieure pouvant provoquer des interactions.

Raccordez la base comme représenté sur le croquis. Pour des raisons de sécurité, n'utilisez que le bloc d'alimentation fourni avec l'appareil ainsi que le câble de raccordement téléphonique ci-joint.

Prise de raccordement téléphonique

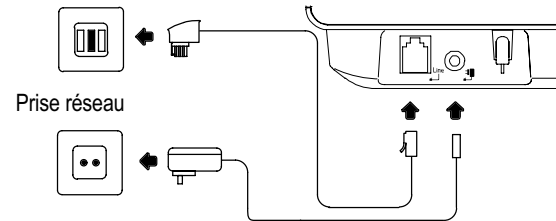

Attention : Utilisez pour la base avec répondeur le bloc d'alimentation référence VD060060I dont les données de sortie sont : 6 V, 600 mA.

Raccorder le chargeur²

Raccordez le chargeur comme représenté sur le croquis. Pour des raisons de sécurité, n'utilisez que le bloc d'alimentation fourni avec l'appareil.

Prise réseau

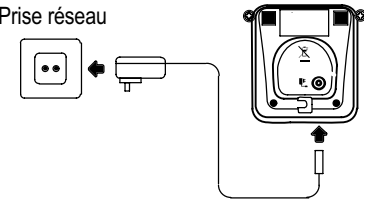

Attention : Utilisez pour le chargeur le bloc d'alimentation référence SY-06030-GS dont les données de sortie sont : 6 V, 300 mA.

² N'est valable que pour les kits téléphoniques avec au moins deux combinés → "Contrôler le contenu de l'emballage" à la page 33.

Mettre votre téléphone en service

Mettre en place le pack de piles rechargeables

Ouvrez le compartiment à piles. Enfoncez la fiche du pack de piles rechargeables dans la prise située dans le compartiment à piles. Insérez le pack de piles rechargeables dans le compartiment à piles. N'utilisez que le pack de piles rechargeables fourni avec l'appareil. Veillez à ne pas coincer le câble. Fermez le compartiment à piles.

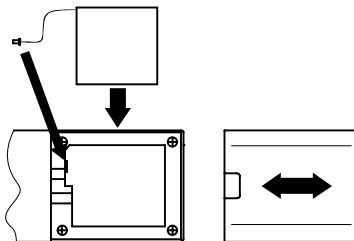

Recharger le pack de piles rechargeables

 Pour la première mise en service, posez le combiné sur la base / le chargeur pour une durée **d'au moins 20 heures**.

Le combiné chauffe lors du chargement. C'est normal et ce n'est pas dangereux. Ne chargez pas le combiné avec des chargeurs d'un autre fabricant. Le **niveau actuel de chargement des piles** s'affiche à l'écran:



Plein



Moyen



Faible



Vide

Réglage de la date et de l'heure

Vous réglez la date et l'heure via le menu. La page 49 vous donnera la position dans le menu.

Paramétrer la langue de l'écran

La langue de l'écran existe en allemand, anglais, italien et français. Vous pouvez paramétrer la langue via le menu. La page 48 vous donnera la position dans le menu.

F Prise d'appel automatique / Réponse autom.

Si vous avez activé la fonction, l'appel sera automatiquement réceptionné quand vous prendrez le combiné de la base. La prise d'appel automatique s'active ou se désactive via le menu. La page 48 vous donnera la position dans le menu.

Installations à postes supplémentaires

La page 46 vous donnera de plus amples informations au cas où vous désiriez raccorder votre téléphone à une installation à postes supplémentaires.

Paramétrer la date et l'heure du répondeur



La date et l'heure de votre répondeur sont automatiquement reprises par le combiné.

Réduction du rayonnement (mode ÉCO)

 Réglage usine = Mode ECO → Activer



En comparaison avec les téléphones sans fil DECT standard, le rayonnement est considérablement réduit, aussi bien en mode de communication qu'en mode veille, quand le mode ECO est activé.

 En cas de besoin, vous pouvez augmenter la portée du système téléphonique en désactivant le mode ECO  page 48 (Mode ECO → Désactiver).

3 Éléments de manipulation

Dans ce mode d'emploi, les touches de votre téléphone seront représentées par la suite par des icônes encadrées standardisées. C'est pourquoi il peut y avoir de légères différences entre les icônes des touches de votre téléphone et celles utilisées ici.

Combiné

- 1 Haut-parleur
- 2 Écran
- 3 Touche de menu "Info"
- 4 Touche softkey droite
- 5 Vers le haut / Répétition automatique des derniers numéros
- 6 Touche R (Flash)
- 7 Vers la droite / Menu SMS
- 8 Raccrocher, mode veille
- 9 Pavé numérique
- 10 Touche # / Verrouillage du clavier
- 12 Microphone
- 10 Touche * / Désactiver la sonnerie d'appel / Numérotation temporaire par tonalité
- 13 Touche de communication
- 14 Vers le bas / Liste d'appels
- 15 Vers la gauche / Répertoire
- 16 Mode mains-libres
- 17 Touche softkey gauche
- 18 Haut-parleur sur la face arrière

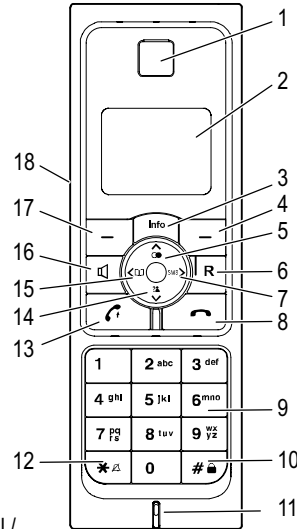

Base (répondeur)

- 1 Haut-parleur
- 2 Écran
- 3 Chercher le combiné (Paging)
- 4 Volume sonore +
- 5 Reproduction de messages
- 6 Message suivant
- 7 Stop
- 8 Volume sonore -
- 9 Message précédent
- 10 Répondeur marche / arrêt
- 11 Effacer
- 12 Contacts de chargement
- 13 Diode électroluminescente : SMS
- 14 Diode électroluminescente : affichage de communications
- 15 Diode électroluminescente : puissance

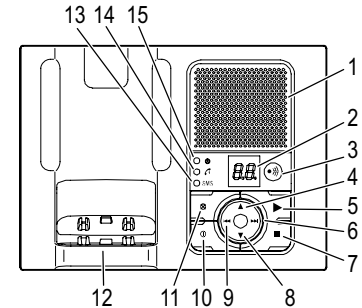















Introduction





4 Introduction

















Dans ce chapitre, vous trouverez des informations de base vous expliquant comment vous servir du mode d'emploi et du téléphone.

Mode de représentation dans le mode d'emploi

Visualisation	Description
	Visualisation des touches
	Appuyer brièvement sur la touche représentée
2 sec. 	Appuyer 2 secondes sur la touche représentée
Maintenir 	Maintenir appuyée la touche représentée
Relâcher 	Relâcher la touche représentée
	Saisir des chiffres ou des lettres
	Le combiné sonne
	La base sonne
	Prendre le combiné de la base
	Poser le combiné sur la base
	Visualisation des textes de l'écran
	Visualisation des icônes de l'écran
	Appuyer sur la touche softkey  page 35

Icônes et textes à l'écran du combiné

Icône	Description
	Constant : affichage de la capacité des piles. Segments défilants : le pack de piles rechargeables se recharge  page 34.
	Constant : la fonction d'alarme est activée. Clignotant : alarme.
hh:mm jj/mm	Affichage de l'heure et de la date  page 49.

	Constant : vous passez une communication. Clignotant : un appel vous parvient  page 39.
	De nouveaux appels se trouvent dans la liste d'appels  page 50.
	Le répondeur est branché.
	De nouveaux messages se trouvent sur le répondeur.
	La sonnerie d'appel est débranchée  page 40.
	Le mode mains-libres est activé  page 40.
	Le verrouillage du clavier est activé  page 40.
	Constant : vous avez un nouveau SMS ¹  page 52. Clignotant : la mémoire SMS est pleine.
	Le microphone est mis sur silencieux  page 40.
	Constant : la liaison avec la base est bonne. Clignotant : la liaison avec la base s'interrompt. Rap- prochez-vous de la base.

¹ **SMS** : Short Message Service = Service pour l'envoi de messages courts.

Mode veille

Toutes les descriptions dans ce mode d'emploi partent du principe que le combiné se trouve en mode veille. Vous parviendrez au mode veille en appuyant sur la touche .

Mode économie d'énergie

Au bout d'un certain temps en mode veille, le combiné passe en mode économie d'énergie. L'écran n'est maintenant plus éclairé. Appuyez sur une touche quelconque pour activer le mode veille.

Touches de navigation

Les touches softkey (4) et (17) sont occupées par des fonctions différentes dans les divers menus. Dans ce mode d'emploi, elles sont toujours dénommées selon les textes inscrits ci-dessus à l'écran.

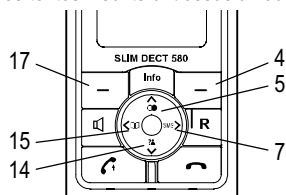









Touche	En mode veille	Dans le menu
4	- Ouvrir le menu principal	- Ouvrir le menu affiché
5	- Ouvrir la liste de répétition automatique des derniers numéros	- Feuilleter dans les menus - Modifier les paramètres
7	- Ouvrir le menu SMS	- Ouvrir le menu affiché - Modifier les paramètres
14	- Ouvrir la liste d'appels	- Feuilleter dans les menus - Modifier les paramètres

15	- Ouvrir le répertoire	- Reculer d'une position - Modifier les paramètres
17	- Téléphoner en interne	- Annuler les opérations de programmation et de sauvegarde - Reculer d'une position

Navigation dans le menu

Vous pouvez accéder à toutes les fonctions via différents menus. Vous trouverez comment parvenir à la fonction désirée dans la structure de menu  page 47.











Menu	Ouvrir le menu principal
 ou 	Sélectionner le sous-menu désiré
OK	Ouvrir le sous-menu
 ou 	Sélectionner la fonction désirée
OK	Ouvrir la fonction
 ou 	Sélectionner le paramètre désiré
	Saisir des chiffres ou des lettres via le pavé numérique.
OK	Confirmer les entrées
Retour	Reculer d'une position
	Annuler les opérations de programmation / de sauvegarde, mode veille

 Chaque opération est automatiquement interrompue si vous n'effectuez pas de saisie dans les 30 secondes.

Introduction

Créer des enregistrements dans le répertoire - exemple

L'exemple **Créer des enregistrements dans le répertoire** vous explique comment naviguer dans les menus et saisir des données. Pour tous les réglages, procédez comme dans cet exemple.

	Ouvrir le répertoire
Option	Appuyer
	S'il n'existe pas encore d'enregistrement dans le répertoire, l'étape "Option" sera automatiquement sautée.
 ou  , OK	Sélectionner la fonction et confirmer
 	Saisir le nom et continuer
 	Saisir le numéro d'appel et continuer
 ou  , OK	Sélectionner le groupe et confirmer

5 Téléphoner

Prendre un appel

ou Prendre l'appel

Terminer la communication

ou Terminer la communication

Allumer et éteindre le combiné

Afin de ménager les piles rechargeables, vous pouvez éteindre le combiné.

2 sec. **Oui** Désactiver le combiné

4 sec. Allumer le combiné

Appeler

Saisir le numéro d'appel (max. 24 chiffres)

Suppr. Effacer le dernier chiffre en cas de saisie erronée

Composer le numéro

Vous pouvez appuyer d'abord sur la touche de communication / touche mains-libres et obtenir ainsi la tonalité. Les chiffres saisis de votre numéro d'appel seront immédiatement composés. Une correction individuelle de chiffres du numéro d'appel n'est pas possible quand la communication est établie de cette manière.

Répétition automatique des derniers numéros

Votre téléphone enregistre les 20 derniers numéros composés dans une liste de répétition automatique des derniers numéros. Vous trouverez de plus amples informations page 50.

Ouvrir la liste de répétition automatique des derniers numéros

ou , Sélectionner l'enregistrement et établir la communication

Rappeler des appels entrés

Votre téléphone enregistre 30 appels dans une liste d'appels page 50.

Ouvrir la liste d'appels

ou , Sélectionner l'enregistrement et établir la communication

Composer des numéros d'appel à partir du répertoire

Il faut que vous ayez déjà enregistré des numéros d'appel dans le répertoire page 38 et 49

Ouvrir le répertoire

ou , Sélectionner l'enregistrement et établir la communication

Téléphoner en interne¹

Téléphoner en interne

Vous devez avoir déclaré deux ou plusieurs combinés (MT1, MT2, ...) sur votre base pour pouvoir téléphoner gratuitement en interne.

MT1 : **Int** ,
 ou , **OK** Composer le numéro interne du combiné désiré

MT2 : Prendre une communication interne sur un autre combiné

MT1 / MT2 : Terminer une communication interne

Transférer des communications externes en interne

MT1 : **Int** ,
 ou , **OK** Composer un numéro interne pendant la communication externe.

MT2 : Prendre une communication interne sur un autre combiné



MT1 : Transférer une communication

¹ Téléphoner en interne n'est possible qu'avec au moins deux combinés "Contrôler le contenu de l'emballage" à la page 33.

Téléphoner

Intercommunication / Va-et-vient

Pendant une communication externe, vous pouvez sélectionner un autre combiné pour intercommuniquer. Le correspondant externe sera maintenu en ligne pendant que vous parlez avec le correspondant interne. Vous pouvez répéter cette opération autant de fois que vous le désirez.



MT1 : **Int** ,
 ou  , **Dir.** Composer un numéro interne pendant la communication externe.

MT2 :  Prendre une communication interne sur un autre combiné

MT1 : **Va.V.** Changer de correspondant

Mener des conférences téléphoniques

Une communication externe peut être transformée en conférence téléphonique avec un autre correspondant interne.

MT1 : **Int** ,
 ou  , **Dir.** Composer un numéro interne pendant la communication externe.

MT2 :  Prendre une communication interne sur un autre combiné

MT1 : **Conf** Commencer la conférence

MT1 : **Sing.** Continuer uniquement la communication interne

MT1 / MT2 :  Terminer la conférence

Régler le volume sonore de l'écouteur

Vous pouvez adapter le volume sonore sur 5 sensibilités pendant une communication.

 ou  Sélectionner le volume sonore désiré

Affichage de la durée de la communication

Pendant une communication, sa durée s'affiche en heures, minutes et secondes.

Mode mains-libres

Utilisez cette fonction pour entendre le correspondant par l'intermédiaire du haut-parleur.

 Activer le mode mains-libres

 Désactiver le mode mains-libres

Mettre le microphone du combiné sur silencieux

Vous pouvez activer et désactiver le microphone du combiné pendant une communication téléphonique.

 Désactiver le microphone (le mettre sur silencieux)

 Activer le microphone

Verrouillage du clavier

Le verrouillage empêche que vous n'appuyiez sur des touches par inadvertance.

2 sec.  Activer le verrouillage du clavier

 Lorsque le verrouillage du clavier est activé, vous pouvez comme d'habitude réceptionner des appels entrants. Les numéros d'appel d'urgence peuvent être composés même quand le verrouillage du clavier est activé.

2 sec.  Désactiver le verrouillage du clavier

Mélodie de sonnerie d'appel du combiné

Vous pouvez désactiver la mélodie de la sonnerie d'appel du combiné.

2 sec.  Désactiver la mélodie de la sonnerie d'appel

 Les communications entrantes sont maintenant signalées par la base et non plus par le combiné.

2 sec.  Activer la mélodie de la sonnerie d'appel

Comment chercher le combiné (Paging)

Si vous avez égaré votre combiné, vous pouvez le retrouver facilement grâce à un son de recherche.

  Lancer le son de recherche

 ou  Terminer le son de recherche

6 Répertoire/Liste d'appels

Répertoire

Vous pouvez enregistrer 200 numéros d'appel et le nom y afférant dans votre répertoire.

Les noms peuvent avoir au maximum 15 positions, les numéros d'appel 24 chiffres.

- Saisissez toujours les numéros d'appel avec l'indicatif afin que le téléphone puisse aussi attribuer les communications locales entrantes à un enregistrement du répertoire.
- Si la capacité de mémoire est épuisée, l'écran affiche le message "Mémoire pleine" lors de la prochaine sauvegarde. Afin de créer à nouveau de la place, vous devez d'abord effacer un autre enregistrement.
- Les enregistrements du répertoire sont rangés par ordre alphabétique. Pour accéder directement à l'enregistrement désiré, appuyez sur l'initiale correspondante.

Saisir le nom

Des lettres sont gravées sur les touches numériques. En appuyant plusieurs fois sur la touche adéquate, vous pouvez saisir des lettres, des chiffres et des symboles.



Pour saisir deux fois la même lettre, appuyez sur la lettre correspondante. Attendez que le curseur soit passé derrière la lettre. Puis tapez la lettre une nouvelle fois.

Vous trouverez comment

- créer des enregistrements du répertoire
 - modifier des enregistrements du répertoire
 - effacer des enregistrements du répertoire et
 - occuper les touches de sélection rapide,
- dans la structure de menu "Répertoire" ➤ page 49.

Sélection de groupes

Vous pouvez attribuer des groupes aux enregistrements de votre répertoire possédant des propriétés que vous avez paramétrées.

Vous trouverez comment

- attribuer des groupes à vos enregistrements,
 - modifier le nom des groupes et
 - attribuer des mélodies,
- dans la structure de menu "Répertoire" ➤ page 49.

Liste d'appels

30 numéros d'appel en tout peuvent être sauvegardés dans une liste d'appels.



L'affichage du numéro d'appel (**CLIP**¹) est un service optionnel de votre opérateur. Votre téléphone affiche à l'écran les numéros d'appel si votre opérateur offre ce service. Veuillez lui demander de plus amples informations.

Vous trouverez comment

- faire afficher les numéros d'appel issus de la liste d'appels,
 - sauvegarder dans le répertoire des numéros d'appel issus de la liste d'appels et
 - effacer des numéros d'appel de la liste d'appels,
- dans la structure de menu "Liste d'appels" ➤ page 50.

Numéros d'appel spéciaux

Dix numéros d'appel importants pour vous peuvent être sauvegardés. Les enregistrements sont automatiquement disponibles pour tous les combinés.

Vous trouverez comment

- vous faire afficher les enregistrements,
 - modifier les enregistrements et
 - effacer les enregistrements,
- dans la structure de menu "Numéros d'appel spéciaux" ➤ page 50.

¹ **CLIP** : Calling Line Identification Presentation = Affichage du numéro d'appel d'un correspondant.

Répondeur

7 Répondeur

Manipulations sur le combiné



Votre répondeur dispose d'un guide parlé de l'utilisateur. Tenez compte de ces instructions et indications.

Ouvrir le menu de réglage

Vous effectuez les paramètres du répondeur via votre combiné
☞ page 47.

Activer / désactiver le répondeur

Vous branchez/débranchez le répondeur via le combiné
☞ page 47.

Réglage de la langue

La réponse vocale du répondeur est en anglais et n'est pas modifiable.

Régler la date et l'heure

Lors de la reproduction des messages, le jour de la semaine et l'heure d'entrée de chaque message se feront entendre. Paramétrage de la date et de l'heure ☞ page 49.

Durée d'enregistrement maximale

Le répondeur enregistre jusqu'à 59 messages. La durée d'enregistrement maximum est de 15 minutes. La longueur d'enregistrement des messages est réglable ☞ page 47. Si la capacité de la mémoire est épuisée et que celle-ci ne peut plus sauvegarder de nouveaux messages, plus aucun appel ne sera enregistré.

Report de la prise d'appel

Vous pouvez sélectionner de 2 à 8 sonneries d'appel. De plus, vous pouvez utiliser le paramétrage Fonction éco pour la consultation préalable à distance gratuite. Cette consultation préalable à distance vous permet de constater gratuitement si de nouveaux messages se trouvent sur votre répondeur.

- Si vous avez de nouveaux messages, votre appel sera pris au plus tard après la 2ème sonnerie.
- Si vous n'en avez pas, votre appel ne sera pris qu'après la 4ème sonnerie. Raccrochez avant la 4ème sonnerie. Vous ne paierez ainsi aucune taxe.

Vous trouverez d'autres informations via la consultation à distance
☞ page 44.

Écoute amplifiée de messages entrants

Vous pouvez, par l'écoute amplifiée, entendre les appels entrants sans pour autant répondre à l'appel.

Oui

Activer l'écoute amplifiée

Fin

Désactiver l'écoute amplifiée

Intercepter un appel

Si le répondeur a déjà répondu à un appel, vous pouvez intercepter celui-ci. L'enregistrement du message est, dans ce cas, interrompu.



Intercepter un appel

Sélectionner le mode des annonces

Votre répondeur met à votre disposition deux textes d'annonce prédéfinis. Après le texte d'annonce "Rép.-Enreg.", vous pouvez laisser un message. Dans le cas du texte d'annonce "Rép. Seul", il s'agit d'une simple annonce après laquelle vous ne pouvez pas laisser de message. Vous pouvez remplacer les deux textes d'annonce par vos propres textes. Si la mémoire du répondeur est pleine, c'est le texte d'annonce "Rép. Seul" qui se fera automatiquement entendre. Vous trouverez de plus amples informations
☞ page 47.

Enregistrer / Effacer des annonces

Enregistrer des annonces

Avant d'enregistrer une annonce, sélectionner le mode d'annonce (Rép.-Enreg./Rép. Seul) pour lequel vous désirez enregistrer une annonce personnelle. La durée de l'annonce personnelle ne doit pas dépasser 60 secondes.

Effacer l'annonce personnelle et retourner à l'annonce standard

Si vous effacez votre annonce personnelle, l'annonce standard prédéfinie sera à nouveau activée. Vous trouverez de plus amples informations
☞ page 47.

Ouvrir le menu de messages

Menu	Ouvrir le menu principal
↑ ou ↓, Répondeur, OK	Sélectionner le sous-menu et confirmer
↑ ou ↓, Écouter mess., OK	Sélectionner le menu de messages et confirmer

Fonctions des touches du menu de messages

Le tableau suivant vous donne une vue d'ensemble des fonctions individuelles de chaque touche dans le menu de messages.

Touche	Fonctions
	Reproduction via le haut-parleur
↑ ou ↓	Régler le volume sonore
Pause	Interrompre / poursuivre la reproduction de messages
4	Faire répéter un message
2 x 4	Écouter le message précédent
5 ou Effac.	Effacer le message pendant l'écoute
6	Écouter le message suivant
	Quitter le menu de messages et retourner en mode veille

Écouter les messages enregistrés

Les messages enregistrés sont reproduits dans l'ordre dans lequel ils sont entrés. Le jour de la semaine et l'heure sont toujours indiqués avant la reproduction de chaque message.

Effacer tous les anciens messages

Tous les messages déjà écoutés sont effacés.

Menu	Ouvrir le menu principal
↑ ou ↓, Répondeur, OK	Sélectionner le sous-menu et confirmer
↑ ou ↓, Effacer mess., OK	Sélectionner la fonction et confirmer
Oui / Non	Appuyer
	Les messages effacés ne peuvent pas être restaurés !

Répondeur

Consultation à distance

Vous pouvez appeler votre répondeur pour écouter les messages et effectuer d'autres fonctions à condition que votre téléphone soit équipé de la fonctionnalité de numérotation par tonalité. La consultation à distance doit être activée ☞ page 47.

Code PIN pour la consultation à distance

Le code PIN est réglé à l'usine sur "0000". Il est recommandé de modifier le code PIN usine "0000". Modifier le code PIN ☞ page 47.

Démarrer la consultation à distance



Composer le numéro d'appel personnel



Appuyer sur ces touches pendant l'annonce et saisir le code PIN



En cas de saisie erronée, vous entendez à nouveau l'annonce du répondeur. Si le code PIN a été saisi de manière erronée, la ligne est alors automatiquement coupée.

Vous avez maintenant la possibilité de d'effectuer d'autres fonctions ☞
Tableau de fonctions des touches de la consultation à distance

Brancher le répondeur à distance



Composer le numéro d'appel personnel



Si vous avez oublié de brancher votre répondeur, votre appel ne sera réceptionné qu'au bout de 10 sonneries.



Appuyer sur ces touches pendant l'annonce et saisir le code PIN



Brancher / débrancher le répondeur

Vous avez maintenant la possibilité d'effectuer d'autres fonctions ☞
Tableau de fonctions des touches de la consultation à distance

Fonctions des touches de la consultation à distance



La consultation à distance est automatiquement interrompue si vous n'effectuez pas de saisie dans les 8 secondes.

Le tableau suivant vous donne une vue d'ensemble des fonctions individuelles de chaque touche.

Touche	Fonctions
1	Écouter le menu d'aide
2	Démarrer la reproduction de tous les messages
3	Démarrer la reproduction des nouveaux messages
4	Faire répéter le message en cours
2 x 4	Écouter le message précédent
5	Supprimer le message pendant l'écoute
6	Écouter le message suivant
7	Sélectionner le mode d'annonce : "Rép.-Enreg." ou "Rép. Seul"
8	Écouter le texte d'annonce actuellement paramétré
9	Enregistrer le texte d'annonce : "Rép.-Enreg." ou "Rép. Seul"
0	Brancher / débrancher le répondeur
#	Terminer l'enregistrement du texte d'annonce
	Raccrocher pour terminer la consultation à distance.

Manipulations sur la base



Votre répondeur dispose d'un guide parlé de l'utilisateur. Tenez compte de ces instructions et indications.

Activer / désactiver le répondeur



Brancher / débrancher le répondeur

Régler le volume sonore

Vous pouvez régler le volume sonore sur 5 sensibilités.

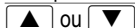

Régler le volume

Écouter / effacer les messages enregistrés

Écouter les messages

Les messages enregistrés sont reproduits dans l'ordre dans lequel ils sont entrés. Le jour de la semaine et l'heure sont toujours indiqués avant la reproduction de chaque message.



Écouter les messages



Arrêter la reproduction



Répéter le message



Message précédent



Message suivant

Effacer un message



Écouter le message à effacer



Effacer pendant la reproduction

Effacer tous les messages

Tous les messages déjà écoutés doivent être effacés.



Démarrer l'opération de suppression



Effacer les messages

Écran du répondeur

L'écran du répondeur indique l'état de l'appareil.

--

Répondeur débranché

0-59

Répondeur branché, nombre de messages enregistrés



S'il existe de nouveaux messages, l'affichage des messages enregistrés clignote.

rA

Apparaît quand un combiné opère des paramètres sur le répondeur.

rE

Apparaît quand un message est enregistré.

Installations à postes supplém. / services confort

8 Installations à postes supplém. / services confort

Touche R sur des installations à postes supplémentaires

Si votre téléphone est raccordé à une installation à postes supplémentaires, vous pouvez au moyen de la **touche R** tirer profit de certaines fonctions comme par ex. le transfert d'appels et le rappel automatique. Veuillez lire le mode d'emploi de votre installation à postes supplémentaires pour connaître le temps de flash à paramétrer pour tirer profit de ces fonctions. Votre revendeur, auprès duquel vous avez acheté l'installation, vous informera si votre téléphone fonctionne impeccablement sur ce genre d'installation. Vous réglez le temps de flash via le menu. La page 48 vous donnera la position dans le menu.

Chiffre de la ligne principale

Sur les installations à postes supplémentaires, vous devez composer un certain numéro pour obtenir une tonalité de la ligne principale. Vous pouvez sauvegarder ce chiffre de la ligne principale. Quand votre téléphone reconnaît ce chiffre de la ligne principale avant un numéro saisi, une **pause de numérotation** sera automatiquement introduite après le chiffre de la ligne principale. Paramétrage du chiffre de la ligne principale  page 48.

Entrer manuellement la pause de numérotation

Vous pouvez, après le chiffre de la ligne principale, insérer **manuellement** une **pause de numérotation** pour pouvoir continuer à composer le numéro sans avoir à attendre la tonalité.

2 sec. Insérer une pause de numérotation

Après le chiffre de la ligne principale, le numéro est composé au bout d'un temps déterminé.



La pause de numérotation peut également être sauvegardée lors de la saisie de numéros d'appel dans le répertoire [mémoire de numéros d'appel].

Touche R et services confort

Votre téléphone supporte les services confort de votre opérateur, comme par ex. le va-et-vient, la signalisation d'appel en instance et la conférence. Via la **touche R** vous pouvez tirer profit de ces services confort. Veuillez demander à votre opérateur quel temps de flash vous devez paramétrer pour tirer profit des services confort. Adressez-vous également à lui pour la déconnexion de ces services. Vous réglez le temps de flash via le

menu. La page 48 vous donnera la position dans le menu.

Affichage du numéro d'appel (CLIP¹)



L'affichage du numéro d'appel est un service confort de votre opérateur. Veuillez lui demander de plus amples informations.

Si cette fonction est à votre disposition sur votre ligne téléphonique, le numéro du correspondant sera affiché dès que le téléphone sonnera. Si votre correspondant a bloqué la transmission de son numéro, un message correspondant sera affiché. Le numéro d'appel ne peut pas être affiché et ainsi ne peut pas non plus être sauvegardé dans la liste d'appels.

Répondeur dans le réseau téléphonique

Le répondeur dans le réseau téléphonique est un service confort offert par beaucoup d'opérateurs. Si votre opérateur met à votre disposition un répondeur dans le réseau téléphonique, vous serez informé par une icône de la présence de nouveaux messages (VMWI²). Vous ne pouvez disposer de cette fonction que si votre opérateur offre ce service. Veuillez lui demander de plus amples informations.

Si vous avez activé le service confort et que de nouveaux messages se trouvent sur votre répondeur dans le réseau téléphonique, vous pouvez désactiver manuellement la visualisation via le menu sans écouter le message. La page 48 vous donnera la position dans le menu.

Msg Wait Non

OK

Désactiver la visualisation

¹ CLIP : Calling Line Identification Presentation = Affichage du numéro d'appel d'un correspondant.

² VMWI : Visual Message Waiting Indication = Affichage optique de nouveaux messages.

9 Structure du menu

Menu principal

Vous parvenez au menu principal en appuyant sur la touche softkey **Menu**. Vous trouverez comment vous déplacer dans le menu et effectuer des saisies à la page 37.

SMS¹

Écrire SMS	 Option	Envoi	Entrer numéro	Envoi
			Option	Répertoire
				Répétition
				Liste d'appels
		Sauvegarder		
		Modèle		
Boîte récep. ²				
Boîte d'envoi				
Modèle				
Paramètres SMS	Serveur SMS		Serveur SMS1 - 4	
	Serveur envoi		Serveur SMS1/2	
	Alarme SMS		Activer/Désactiver	

Répondeur

Écouter mess.		
Effacer mess.		
Répond. ON/OFF	Activer/Désactiver	
Message annonc	Enregist.mess.	Rép.-Enreg./Rép. Seul
	Écouter mess.	Rép.-Enreg./Rép. Seul
Régl.répondeur	Mode Répondeur	Rép.-Enreg./Rép. Seul
	Délai av. rép.	Fonction éco
		2 Sonneries - 8 Sonneries
	Durée enregist	30s - 180s
	Co-écoute	Activer/Désactiver
Accès à dist.	Désactiver	
	Activer	Ancien PIN
		➔ Nouveau PIN
		➔ Répéter PIN

¹ Autres informations relatives aux messages écrits par SMS

 page 52.



² Jusqu'à 30 messages peuvent être sauvegardés.

Structure du menu





Sons

Sonnerie	Sonnerie Ext.	Mélodie 1 - 15
	Sonnerie Int.	Mélodie 1 - 15
	Vol. sonnerie	Désactiver, 1 - 5
	Silence	Désactiver/Bips
Bips	Bips touches	Activer/Désactiver
	Bips confirm.	Activer/Désactiver
	Accu faible	Activer/Désactiver
	Hors portée	Activer/Désactiver

Paramètres

Réglages comb.	Appel direct	PIN Système ¹	Désactiver
			Activer 
	Sélect. base	Base 1 - 4	
	Ecran	Contraste 1 - 8	
		Nom combiné 	
	Langue	Deutsch/English/ Italiano/Français	
	Réponse autom.	Activer/Désactiver	
	Décl combiné	Base 1 - 4	PIN Système
	Annul combiné	PIN Système	
	Mise à 0 comb.	Oui/Non	

¹ Le code PIN système est réglé à l'usine sur le "0000".

▼ Réglages base	Sonnerie	Sonn. Alarme	Mélodie 1 - 5
		Vol. sonnerie	Désactiver, 1 - 5
	Priorité Comb. ²	Tous combinés	
		Sélect. comb.	Combiné 1 - 5 
			 2/4/6/8
	Mode de num.	Tonalité/Impulsions	
	Temps Flash	80ms - 800ms	
	Msg Wait Non		
	PIN Système	Ancien PIN	Nouveau PIN 
			 Répéter PIN
	Indic. Réseau 		
	Mode ECO	Activer/Désactiver	
▼	Mise à zéro ³	Entrer PIN	Oui/Non



² Vous pouvez ici choisir si un appel entrant doit sonner sur tous les combinés déclarés ou s'il doit seulement sonner sur un combiné bien précis.

³ **Attention** : Tous les messages existants, même les nouveaux messages / messages pas encore écoutés sont effacés par un reset de système !



↓ Réveil/ Alarme	Heure/Date	Format heure	12 heures/24 heures
Alarme	Format date	mm/jj ou jj/mm	
	Entrer heure		
	Entrer date		
	Entrer heure		
	Alarme ON/OFF	Désactiver	
Sonn. Alarme	Unique		
	Journalier		
	Sonn. Alarme	Mélodie 1 - 15	

Répertoire

Si besoin, / sélectionner l'enregistrement désiré

Option	Nouv. Entrée	Nom	 <input type="button" value="↓"/>
		Numéro	 <input type="button" value="↓"/>
		Sélect. groupe	Aucun group
			Famille
			Affaires
			Amis
			Services
			VIP
			Autres
			En général

Structure du menu

↓ Éditer entrée	Nom	 <input type="button" value="↓"/>
	Numéro	 <input type="button" value="↓"/>
	Sélect. groupe	Aucun group
		Famille
		Affaires
		Amis
		Services
		VIP
		Autres
		En général
Voir détails	Nom	<input type="button" value="↓"/>
	Numéro	<input type="button" value="↓"/>
	Groupe Mélodie	
Copier	Combiné 1, 2, ..	
Copier tout	Combiné 1, 2, ..	
Effacer entrée	Oui/Non	
Effacer liste	Oui/Non	
Capacité		
Éditer groupe	Sélectionner le groupe	Renommer
		Sonn. Alarme
Accès direct	Numéro 2 - 9	Sélectionner l'enregistrement



Si la touche de sélection rapide est déjà occupée, l'enregistrement sera affiché.

Structure du menu

Numéros d'appel spéciaux

Si besoin, / sélectionner l'enregistrement désiré

Option	Voir détails	Nom
		Numéro
	Effacer entrée	
	Éditer entrée	Nom <input type="button" value="M"/> <input type="button" value="▼"/>
		Numéro <input type="button" value="M"/>
	Effacer liste	Oui/Non

Liste d'appels

Si besoin, / sélectionner l'enregistrement désiré

Option	Voir détails	
	Effac.	
	Effacer liste Oui/Non	
	Appeler numéro Option Répertoire	
		Répétition
		Liste d'appels
	Sauveg. Numéro	Voir Nouv. Entrée
	Paramètres	Catégorie Tous mess.
		Sans rép.
		Alerte appels Activer/Désactiver

SMS

Voir SMS Seite 47.

Répétition automatique des derniers numéros

Si besoin, / sélectionner l'enregistrement désiré

Option	Effac.	Oui/Non
	Effacer liste	Oui/Non
	Appeler numéro Option	Répertoire
		Répétition
		Liste d'appels
	Sauveg. Numéro	Voir Nouv. Entrée

10 Fonctions particulières

Système de numérotation

Vous pouvez utiliser votre téléphone tant avec les centrales téléphoniques analogiques (numérotation par impulsions) qu'avec les nouvelles centrales téléphoniques numériques (numérotation par tonalité). Le système de numérotation est programmé via le menu. La page 48 vous donnera la position dans le menu.

Numérotation temporaire par tonalité

Si vous ne pouvez utiliser votre téléphone qu'avec la numérotation par impulsions, vous n'avez pas besoin de renoncer aux avantages de la numérotation par tonalité (par ex. : consultation d'un répondeur dans le réseau téléphonique). Vous pouvez passer à la numérotation par tonalité pendant que vous passez une communication.

2 sec.  Appuyer sur la touche pendant la communication

Le téléphone repasse automatiquement en numérotation par impulsions quand la communication est terminée.

Alarme



Cette fonction vous permet d'être alerté par votre combiné à un moment donné. La page 49 vous donnera la position dans le menu.

Appel direct

Cette fonction vous donne la possibilité de sauvegarder un numéro d'appel précis qui sera automatiquement appelé quand vous appuierez sur une touche quelconque (exceptée **Option**). La page 48 vous donnera la position dans le menu.

Sélection rapide

Il faut que vous ayez déjà enregistré des numéros d'appel comme numéros de sélection rapide. La page 49 vous donnera la position dans le menu.





2 sec.  à  Appuyer sur la touche de sélection rapide désirée

Le numéro d'appel mis en mémoire est composé directement.



Copier des enregistrements du répertoire

Vous pouvez copier des enregistrements du répertoire d'un combiné sur un autre.

Copier un seul enregistrement

	Ouvrir le répertoire
	Sélectionner l'enregistrement désiré
Option	Appeler l'option
 , OK	Sélectionner "Copier" et confirmer
 , OK	Sélectionner le combiné et confirmer
Oui / Non	Sélectionner sur le combiné récepteur

Copier tous les enregistrements

	Ouvrir le répertoire
Option	Appeler l'option
 , OK	Sélectionner "Copier tout" et confirmer
 , OK	Sélectionner le combiné et confirmer
Oui / Non	Sélectionner sur le combiné récepteur

11 SMS

Conditions à remplir pour les SMS

Votre raccordement téléphonique doit disposer du service **CLIP**¹. Assurez-vous auprès de votre opérateur que ce service est bien connecté pour votre raccordement téléphonique. Pour tirer profit du service **SMS**², celui-ci doit être activé par votre opérateur.

- Des SMS ne peuvent pas être envoyés à partir de chaque installation à postes supplémentaires.



Si vous désirez envoyer des SMS à partir de votre installation à postes supplémentaires, sauvegardez dans votre combiné, avant le numéro de centre de service, le chiffre de la ligne principale de votre installation.

- Dans le cas des liaisons d'appel par appel, l'envoi de SMS n'est pas possible actuellement.
- L'envoi de messages SMS est payant.
- Si le récepteur n'utilise pas de service SMS sur son réseau fixe ou si son téléphone ne peut simplement pas recevoir de SMS, le SMS sera automatiquement livré sous forme de message vocal.
- Le calcul des frais est effectué par votre opérateur.

Centre de service SMS

La répartition de messages SMS se fait via un centre de service. Si vous désirez envoyer des messages écrits par SMS, vous devez programmer un numéro de centre de service dans votre combiné  page 47. Veuillez demander à l'opérateur de votre choix le numéro de centre de service nécessaire et la manière de procéder pour activer le service SMS.



Votre téléphone est prêt à envoyer des messages écrits par SMS. Des numéros de centre SMS sont déjà programmés dans votre combiné. Activez le centre SMS de votre choix dans le menu SMS  page 47.

¹ **CLIP** : Calling Line Identification Presentation = Affichage du numéro d'appel d'un correspondant.

² **SMS** : Short Message Service = Service pour l'envoi de messages courts.

Serveur SMS 1

Swisscom : 0622100000

Serveur SMS 2

Cablecom : 0435375370

Saisir du texte

Pour la saisie de texte, des lettres sont gravées sur les touches numériques. En appuyant plusieurs fois sur la touche adéquate, vous pouvez saisir des lettres, des chiffres et des symboles. Vous trouverez comment naviguer pour pouvoir écrire un SMS dans la structure de menu

 page 47.



Passer des majuscules aux minuscules

Suppr.

Effacer la dernière position

Maintenir Suppr.

Effacer tout

Modèles de texte pour SMS

5 modèles de texte préprogrammés sont à votre disposition  page 47.

Signal indicateur de SMS (alarme)

Quand vous avez reçu de nouveaux messages écrits, vous en êtes informés par un signal indicateur. Le signal s'active ou se désactive via le menu. La page 47 vous donnera la position dans le menu.

12 Élargissement du système téléphonique



Le mode standard international normé **GAP**¹ règle la compatibilité entre les combinés et les bases de fabricants différents. Il est ainsi possible d'intégrer ensemble des appareils SWITEL et des appareils d'autres fabricants dans un système téléphonique. Il est toutefois possible que certaines fonctions ne soient pas disponibles.



Plusieurs combinés

Vous pouvez déclarer 5 combinés sur votre base.

Déclaration de combinés

Avant de déclarer un combiné, vous devez mettre la base en mode de déclaration.

Maintenir  jusqu'à ce que  clignote Démarrer le mode de déclaration

Déclarez maintenant le combiné  page 48. Pour la déclaration, utilisez le code PIN actuellement paramétré  page 48.

Après la déclaration, le combiné reçoit un numéro d'appel interne. Ce numéro s'affiche à l'écran.

 Pour déclarer des combinés d'autres fabricants, veuillez lire leur mode d'emploi.

Annulation de combinés



 Chaque combiné peut s'annuler soi-même ou annuler d'autres déclarés sur cette base. Le message Déclarer! s'affiche sur l'écran du combiné annulé.

Les combinés sont annulés via le menu. La page 48 vous donnera la position dans le menu.

Plusieurs bases

Vous pouvez augmenter la portée de votre combiné si vous le déclarez sur plusieurs bases. Vous pouvez le déclarer simultanément sur 4 bases différentes. Chaque base a besoin d'une prise téléphonique individuelle. Ces raccordements peuvent porter le même numéro d'appel ou des numéros différents. Sélection de la base  page 48.

 Les communications en cours ne peuvent pas être transférées d'une base à l'autre.

 En cas de besoin, vous pouvez augmenter la portée du système téléphonique en désactivant le mode ECO  page 48 (Mode ECO → Désactiver).

¹ **GAP** : **Generic Access Profile** = Standard pour l'action conjointe de combinés et de bases de fabricants différents.

En cas de problèmes

13 En cas de problèmes

Hotline de service

Si vous avez des problèmes avec votre téléphone, contrôlez d'abord les indications suivantes. En cas de problèmes techniques, vous pouvez vous adresser à notre hotline de service en appelant le numéro 0900 00 1675 en Suisse (frais Swisscom à la date d'impression de ce manuel : CHF 2.00/min). Si vous jouissez des droits de garantie, adressez-vous à votre revendeur. La durée de la garantie est de 2 ans.

Questions et réponses

Questions	Réponses
Pas de liaison possible avec la base	<ul style="list-style-type: none">- Contrôlez que vous êtes déclaré sur la base avec le code PIN correct ☞ page 48.
Pas de communication téléphonique possible	<ul style="list-style-type: none">- Le téléphone n'est pas correctement raccordé ou est perturbé. N'utilisez que le câble de raccordement téléphonique fourni avec l'appareil.- Testez avec un autre téléphone si votre raccordement téléphonique fonctionne.- Le bloc d'alimentation n'est pas branché ou il y a une panne totale de courant.- Le pack de piles rechargeables est vide ou défectueux.- Vous vous êtes trop éloigné de la base.- Le système de numérotation est mal paramétré ☞ page 48.
La liaison est hachée, se coupe	<ul style="list-style-type: none">- Vous vous êtes trop éloigné de la base.- Mauvais lieu d'installation de la base.

Le système ne réagit plus	<ul style="list-style-type: none">- Remettez toutes les fonctions en configuration usine ☞ page 48.- Retirez momentanément le bloc d'alimentation de la prise de courant.
Le pack de piles rechargeables se vide très rapidement	<ul style="list-style-type: none">- Le pack de piles rechargeables est vide ou défectueux.- Posez le combiné correctement sur la base. Nettoyez les surfaces de contact du combiné et de la base avec un chiffon doux et sec.- Mettez le combiné sur la base pour une durée de 20 heures.
L'affichage du numéro d'appel (CLIP ¹) ne fonctionne pas	<ul style="list-style-type: none">- L'affichage du numéro d'appel est un service confort de votre opérateur. Veuillez lui demander de plus amples informations.- Le correspondant a bloqué la transmission de son numéro d'appel.
Le répondeur ne prend pas de messages	<ul style="list-style-type: none">- Assurez-vous que le répondeur est correctement raccordé et branché.- Contrôlez si la mémoire du répondeur est pleine. Le cas échéant, effacez des messages de la mémoire ☞ page 47.
Vous ne pouvez pas consulter à distance	<ul style="list-style-type: none">- Contrôlez que vous utilisez le code de sécurité correct pour la consultation à distance ☞ page 47.- Le téléphone que vous utilisez pour la consultation à distance doit être réglé sur la numérotation par tonalité.

¹ CLIP : Calling Line Identification Presentation = Affichage du numéro d'appel d'un correspondant.

14 Caractéristiques techniques

Caractéristiques techniques

Caractéristique	Valeur
Standard	DECT¹-GAP²
Alimentation en courant (base)	Entrée : 220/230 V, 50 Hz Sortie : 6 V, 600 mA
Alimentation en courant (chargeur)	Entrée : 220/230 V, 50 Hz Sortie : 6 V, 300 mA
Portée	Extérieur : env. 300 m Intérieur : env. 50 m
Mode veille	Jusqu'à 100 h
Durée max. de communication	Jusqu'à 10 h
Pack de piles rechargeables	NiMH 2.4 V 600 mAh
Système de numérotation	Tonalité (DTMF) Impulsions (IWW)
Température ambiante autorisée	10 °C à 30 °C
Humidité atmosphérique relative autorisée	20 % à 75 %
Fonction de flash	80, 100, 120, 180, 250, 300, 600 ou 800 ms

¹ **DECT** : Digital Enhanced Cordless Telecommunication = Standard pour les téléphones sans fil.

² **GAP** : Generic Access Profile = Standard pour l'action conjointe de combinés et de bases de fabricants différents.

Réglages usine

Combiné

Les paramétrages en usine sont rétablis via le menu. La page 48 vous donnera la position dans le menu.

Vol. sonnerie	5	Bips touches	Activer
Interne Melodie	1	Vol. son. du haut-parleur	3
Externe Melodie	2	Répétition	Vide
Accu faible	Activer	Vol. son. de l'écouteur	3
Hors portée	Activer	Langue	Deutsch

Base

Les paramétrages usine sont rétablis via le menu. La page 48 vous donnera la position dans le menu.



Attention : Tous les messages existants, même les nouveaux messages / messages pas encore écoutés sont effacés par une Mise à zéro !

PIN Système	0000	Temps Flash	100 ms
Mode de num.	Tonalité	Sonn. Alarme	1
Indic. Réseau	Vide	Vol. sonnerie	3
Liste d'appels	Vide	Mode ECO	Activer

Caractéristiques techniques

Répondeur

Répondeur	Activer	Durée enregist	60 s
Message annonc	Rép.-Enreg.	Co-écoute	Activer
Délai av. rép.	Fonction éco	Accès à dist.	Activer

Déclaration de conformité

Cet appareil répond aux exigences des directives de l'union européenne (UE) :

1999/5/CE Directive sur les installations de radio et de télécommunication et la reconnaissance réciproque de leur conformité. La conformité à la directive ci-dessus est confirmée par le symbole CE placé sur l'appareil.



Pour obtenir toute la déclaration de conformité, veuillez utiliser le téléchargement gratuit de notre site Internet www.switel.com.

15 Remarques d'entretien / Garantie

Remarques d'entretien

- Nettoyez les surfaces du boîtier avec un chiffon doux et non pelucheux.
- N'utilisez pas de produits d'entretien ou de solvants.

Garantie

Les appareils SWITEL sont fabriqués selon les procédés les plus modernes et sont contrôlés. Des matériaux sélectionnés et des technologies de pointe ont pour effet un fonctionnement irréprochable et une longue durée de vie. La garantie ne rentre pas en jeu si l'exploitant du réseau téléphonique ou une installation à postes supplémentaires éventuellement intercalée est responsable du dysfonctionnement de l'appareil. La garantie n'est pas valable pour les piles, les piles rechargeables ou les packs de piles rechargeables utilisés dans les produits. La période de garantie est de 24 mois à partir de la date d'achat.

Pendant la période de garantie, tous les défauts dus à des vices de matériel ou de fabrication seront éliminés gratuitement. Le droit à la garantie expire en cas d'intervention de l'acheteur ou de tiers. Les dommages provenant d'un maniement ou d'une manipulation incorrects, d'une usure naturelle, d'une mauvaise mise en place ou d'une mauvaise conservation, d'un raccordement ou d'une installation incorrects ainsi que d'un cas de force majeure ou autres influences extérieures sont exclus de la garantie. En cas de réclamations, nous nous réservons le droit de réparer, de remplacer les pièces défectueuses ou d'échanger l'appareil. Les composants remplacés ou les appareils échangés deviennent notre propriété. Les demandes de dommages et intérêts sont exclues tant qu'elles ne reposent pas sur l'intention ou une négligence grossière du fabricant.

Si votre appareil devait malgré tout présenter une défectuosité pendant la période de garantie, veuillez vous adresser, muni de la quittance d'achat, exclusivement au magasin où vous avez acheté votre appareil SWITEL. Tous les droits de garantie basés sur ces dispositions ne peuvent être revendiqués qu'auprès de votre revendeur. À l'échéance des deux ans après l'achat et la remise de nos produits, les droits en matière de garantie ne peuvent plus être revendiqués.

16 Index

A

Activer, 42, 45
Affichage du numéro d'appel, 41, 46
Alarme, 51
Allumer, 39
Annonces, 42
Annulation, 53
Appel direct, 51
Appeler, 39

B

Base, 33, 35, 53
Brancher à distance, 44

C

Caractéristiques techniques, 55
Centre de service, 52
Chargeur, 33
Chiffre de la ligne principale, 46
CLIP, 46
Code PIN, 44
Combiné, 35, 53
Comment chercher le combiné, 40
Communications internes, 39
Composer des numéros, 39
Conférences téléphoniques, 40
Consignes de sécurité, 32
Consultation à distance, 44
Contenu de l'emballage, 33
Copier des enregistrements du répertoire, 51
Créer, 38, 41

D

Date, 34, 42
Déclaration, 53
Déclaration de conformité, 56
Décrocher, 39
Désactivation du micro, 40
Désactiver, 42, 45
Durée d'enregistrement maximale, 42
Durée de la communication, 40

E

Économiseur de taxes, 42
Écoute amplifiée, 42
Écouter, 45
Écouter les messages, 43
Écran, 36, 45
Effacer, 41, 42, 43, 45
Effacer des messages, 45
Élargissement, 53
Éléments de manipulation, 35
Emploi, 36
Enregistrements du répertoire, 38, 41
Enregistrer, 42
Entrer manuellement la pause de numérotation, 46
Éteindre, 39

F

Fonctions, 51
Fonctions des touches, 43, 44

G

Garantie, 57

H

Heure, 42
Hotline de service, 54

I

Icônes, 36
 Icônes à l'écran, 36
 Info, 50
 Installations à postes supplémentaires, 46
 Interception d'appel, 42
 Intercommunication, 40

L

Langue, 42
Langue de l'écran, 34
Liste d'appels, 41

M

Manipulations sur la base, 45
Manipulations sur le combiné, 42
Mélodie, 41
Mélodie de sonnerie d'appel, 40
Menu de messages, 43
Menu de réglage, 42
Menu principal, 47
Messages, 45
Mettre en place le pack de piles rechargeables, 34
Mise en service, 33
Mise sur silencieux, 40
Mode des annonces, 42
Mode ÉCO, 34
Mode économie d'énergie, 37
Mode mains-libres, 40
Mode veille, 37
Modèles de texte pour SMS, 52
Modifier, 41

N

Niveau de chargement des piles, 34
Noms de groupes, 41
Notations, 36
Numéros d'appel spéciaux, 41
Numérotation par impulsions, 51
Numérotation par tonalité, 51
Numérotation temporaire par tonalité, 51

P

Paging, 40
Pause de numérotation automatique, 46
Prise d'appel, 34, 39
Prise directe, 34
Problèmes, 54

Q

Questions et réponses, 54

R

Raccrocher, 39
Rappel, 39
Rechargement, 34
Réduction du rayonnement, 34
Réglage de l'heure et de la date, 34
Réglages usine, 55
Remarques d'entretien, 57
Répertoire, 39, 41, 49, 50
Répétition automatique des derniers numéros, 39, 50
Répondeur, 42
Répondeur dans le réseau téléphonique, 46
Report, 42

S

Saisie de noms, 41
Saisie de texte, 41, 52
Sauvegarder, 38, 41
Sélection de groupes, 41
Sélection rapide, 41, 51
Services confort, 46
Signal indicateur, 52
SMS, 52
Structure du menu, 47
Suppression d'erreurs, 54
Système de numérotation, 51

T

Telefonbuch, 50
Téléphoner, 39
Terminer la communication, 39
Touche R, 46
Touches de navigation, 37
Transfert, 39
Transfert de communication, 39

V

Va-et-vient, 40
Verrouillage du clavier, 40
VMWI, 46
Volume, 45
Volume sonore de l'écouteur, 40

1	Indicazioni di sicurezza	62
2	Mettere in funzione il telefono	63
4	Elementi di comando	65
4	Informazioni introduttive	66
7	Compiere telefonate	69
6	Rubrica telefonica / Elenco chiamate . .	71
9	Segreteria telefonica	72
10	Impianti telefonici interni / Servizi aggiuntivi	76
11	Struttura di menu	77
13	Funzioni speciali	81
14	SMS	82
15	Ampliamento del sistema telefonico . . .	83
13	In presenza di problemi	84
17	Specifiche tecniche	85
15	Consigli per la cura / Garanzia	87
16	Indice alfabetico	88

Indicazioni di sicurezza

1 Indicazioni di sicurezza

Leggere attentamente le presenti istruzioni per l'uso.

Impiego conforme agli usi previsti

Il presente telefono consente di svolgere telefonate all'interno di una rete telefonica. Qualsiasi altro impiego è considerato come non conforme agli usi previsti. Non sono consentite modifiche o trasformazioni non autorizzate. Non aprire per nessuna ragione l'apparecchio autonomamente, né compiere riparazioni di propria iniziativa.

Luogo di installazione

Evitare l'esposizione a fumo, polvere, vibrazioni, sostanze chimiche, umidità, eccessivo calore o irradiazioni solari dirette.

Non utilizzare l'unità portatile in aree esposte al rischio di deflagrazione.

Alimentatore di rete



Attenzione: Utilizzare solo l'alimentatore a spina fornito in dotazione visto che altri alimentatori di rete potrebbero addirittura danneggiare il telefono. Non ostacolare il libero accesso all'alimentatore a spina con mobili o altri oggetti simili.

Accumulatore ricaricabile



Attenzione: Non gettare batterie ricaricabili nel fuoco. Utilizzare solo batterie ricaricabili dello stesso tipo! Osservare la corretta polarità! Pericolo di esplosione durante il caricamento della batteria in caso di errata polarità.

Caduta di tensione

In caso di caduta di tensione non è possibile compiere chiamate con il telefono. Si consiglia di ricorrere in caso di emergenza ad un telefono con filo in grado di funzionare anche senza alimentazione elettrica esterna.

Apparecchiature mediche



Attenzione: Non utilizzare il telefono in prossimità di apparecchiature mediche. Non è possibile escludere il subentro di eventuali interferenze.

Telefoni **DECT**¹ possono causare un fastidioso ronzio in apparecchi acustici.

Smaltimento

Procedere allo smaltimento dell'apparecchio esaurito consegnandolo presso uno dei punti di raccolta istituiti dalla propria società di smaltimento rifiuti comunale (per es. centro di riciclo materiali). Il simbolo riportato qui a lato indica che non è assolutamente consentito smaltire l'apparecchio assieme ai normali rifiuti domestici! Secondo quanto previsto dalla legge sugli apparecchi elettrici ed elettronici, i proprietari di apparecchi esauriti sono per legge tenuti alla consegna di tutti gli **apparecchi elettrici ed elettronici** presso un centro di rilievo rifiuti in raccolta differenziata.

Consegnare le batterie ricaricabili per lo smaltimento presso rivenditori al dettaglio di batterie o centri di raccolta che mettono a disposizione appositi contenitori.

Smaltire **confezioni ed imballaggi** in base a quanto indicato dalle norme in vigore a livello locale.



¹ **DECT:** Digital Enhanced Cordless Telecommunication = Standard per telefoni senza cavo.

2 Mettere in funzione il telefono

Indicazioni di sicurezza



Attenzione: Prima della messa in funzione, leggere attentamente le indicazioni di sicurezza riportate al capitolo 1.

Verificare il contenuto della confezione

La confezione contiene:

Contenuto	Modello DFT 817x			
	8171	8172 ¹	8173 ¹	8174 ¹
Stazione base (segreteria telefonica) con alimentatore di rete	1	1	1	1
Stazione di carica con alimentatore	-	1	2	3
Unità portatile	1	2	3	4
Cavo di collegamento telefonico	1	1	1	1
Accumulatore ricaricabile	1	2	3	4
Istruzioni per l'uso	1	1	1	1

¹ Per ulteriori informazioni riguardo la disponibilità di questo set telefonico si prega di visitare il sito www.switel.com.

Collegare la stazione base



Attenzione: Montare la stazione base con una distanza minima di 1 m da altri apparecchi elettronici in modo da evitare interferenze reciproche.

Procedere al collegamento della stazione base seguendo quanto raffigurato nella figura. Utilizzare per motivi di sicurezza solo l'alimentatore di rete oltre che il cavo di collegamento telefonico forniti in dotazione.

Preso di collegamento telefonico

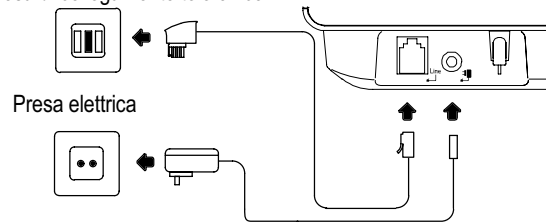

Attenzione: Utilizzare per la stazione base con segreteria telefonica l'alimentatore di rete no. VD060060I con le seguenti prestazioni in uscita: 6 V, 600 mA.

Collegare la stazione di carica²

Procedere al collegamento della stazione di carica secondo quanto indicato nella figura. Per motivi di sicurezza si prega di utilizzare soltanto l'alimentatore di rete fornito in dotazione.

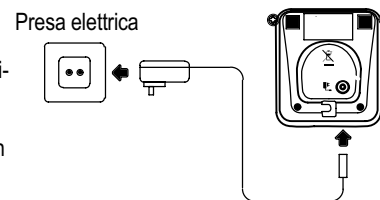

Attenzione: Utilizzare per la stazione base con segreteria telefonica l'alimentatore di rete no. SY-06030-GS con le seguenti prestazioni in uscita: 6 V, 300 mA.

² Vale solo per set telefonici con minimo due unità portatili
 "Verificare il contenuto della confezione" a pagina 63.

Mettere in funzione il telefono

Inserire l'accumulatore ricaricabile

Aprire il vano batteria. Introdurre il connettore dell'accumulatore ricaricabile nella presa presente all'interno del vano batteria. Piazzare l'accumulatore ricaricabile nel vano batteria. Utilizzare esclusivamente l'accumulatore ricaricabile fornito all'interno della confezione. Fare attenzione a non incastrare il cavo. Chiudere infine il vano accumulatore.

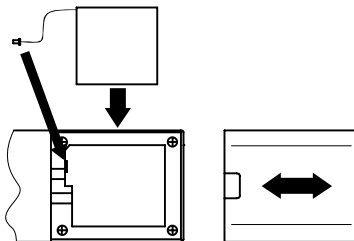

Caricare l'accumulatore ricaricabile

Riporre l'unità portatile in sede di prima messa in funzione per **minimo 20 ore** nella stazione base / stazione di carica.

L'unità portatile si surriscalda durante il processo di carica. Questo è un fenomeno normale e non pericoloso. Evitare di caricare l'unità portatile con dispositivi di carica differenti o estranei. Lo **stato di carica** attuale è visualizzato sul display:



Carico



A metà



Debole



Scarico

Impostare data e ora dell'unità portatile

Una voce di menu consente di impostare data e ora. A pagina 79 è indicata la posizione da scorrere nel menu.

Impostare la lingua di display

La lingua di display è disponibile in tedesco, inglese, italiano e francese. L'impostazione della lingua è compiuta attraverso il menu. A pagina 78 è indicata la posizione da scorrere nel menu.

Accettazione di chiamata automatica / Risposta dir

L'attivazione di questa funzione consente di ricevere automaticamente una chiamata estraendo semplicemente l'unità portatile dalla stazione base. L'accettazione di chiamata automatica è attivata o disattivata nel menu. A pagina 78 è indicata la posizione da scorrere nel menu.

Impianti telefonici interni

A pagina 76 sono riportate ulteriori informazioni nel caso in cui si volesse collegare il telefono ad un impianto telefonico interno.

Impostare data e ora della segreteria telefonica

Data e ora della segreteria telefonica sono impostati automaticamente assumendo le informazioni dalla rispettiva unità portatile.

Riduzione delle radiazioni (modalità ECO)

Configurazione iniziale = Mode ECO → On

















In modalità ECO, le radiazioni sono considerevolmente ridotte sia in modalità conversazione che in modalità di stand-by rispetto ad un telefono cordless a standard DECT.

La portata del sistema telefonico può essere aumentata disattivando la modalità ECO (pagina 78) (Mode ECO → Off).

3 Elementi di comando







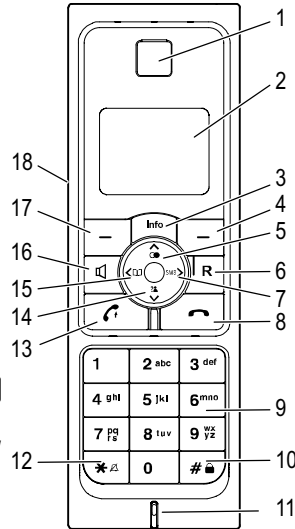



I tasti del telefono riportati nel presente manuale d'istruzioni per l'uso sono raffigurati sotto forma di simboli uniformi all'interno di un riquadro. Sono possibili differenze minime tra i simboli dei tasti sul telefono rispetto ai simboli qui raffigurati.

Unità portatile

- 1 Altoparlante
- 2 Display
- 3 Tasto di menu "Info" 
- 4 Tasto softkey di destra
- 5 Verso sopra  / Ripetizione di chiamata 
- 6 Tasto R (flash) 
- 7 Destra  / Menu SMS 
- 8 Tasto di riaggancio, modalità di stand-by 
- 9 Tasti numerici
- 10 Tasto # / Blocco tastiera 
- 11 Microfono
- 12 Tasto * / Disattivare lo squillo / Selezione a toni temporanea 
- 13 Tasto di chiamata 
- 14 Verso sotto  / Elenco chiamate 
- 15 Sinistra  / Rubrica telefonica 
- 16 Funzione vivavoce 
- 17 Tasto softkey di sinistra
- 18 Altoparlante sul retro



Stazione base (segreteria telefonica)

- 1 Altoparlante
- 2 Display
- 3 Cercare l'unità portatile (funzione di paging) 
- 4 Volume + 
- 5 Riproduzione 
- 6 Messaggio successivo 
- 7 Stop 
- 8 Volume - 
- 9 Messaggio precedente 
- 10 Segreteria telefonica ON / OFF 
- 11 Cancellare 
- 12 Contatti di carica
- 13 LED: SMS
- 14 LED: Visualizzazione di chiamata 
- 15 LED: Power 

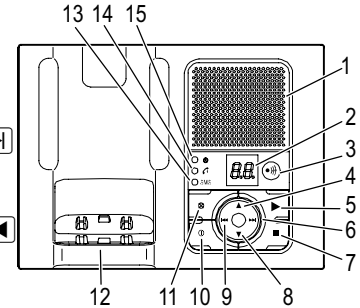

Informazioni introduttive



4 Informazioni introduttive



















In questo capitolo sono riportate le principali informazioni riguardo l'uso delle presenti istruzioni e del telefono.

Modi di rappresentazione delle istruzioni per l'uso

Rappresentazione	Descrizione
	Rappresentazione dei tasti
	Premere brevemente il tasto raffigurato
2 sec. 	Premere il tasto raffigurato per 2 secondi
tenere 	Tenere premuto il tasto raffigurato
rilasciare 	Rilasciare il tasto raffigurato
	Inserire numeri o lettere
	L'unità portatile squilla
	Stazione base squilla
	Estrarre l'unità portatile dalla stazione base
	Riporre l'unità portatile nella stazione base
	Rappresentazione di testi sul display
	Rappresentazione di simboli sul display
	Premere il tasto softkey  pagina 65

Simboli e testi sul display dell'unità portatile

Simbolo	Descrizione
	Costante: Indicazione dello stato di carica delle batterie. Segmenti che scorrono: L'accumulatore ricaricabile è in fase di carica  pagina 64.

	Costante: Funzione allarme inserita. Lampeggiante: Allarme.
hh:mm gg/mm	Indicazione di ora e data  pagina 79.
	Costante: Chiamata in corso. Lampeggiante: Chiamata in arrivo  pagina 69.
	Presenza di nuove chiamate nell'elenco chiamate  pagina 80.
	Segreteria telefonica inserita.
	Si è in presenza di nuovi messaggi sulla segreteria telefonica.
	La segnalazione acustica di chiamata è disinserita  pagina 70.
	La funzione vivavoce è attivata  pagina 70.
	Il blocco tastiera è attivato  pagina 70.
	Costante: Si è in presenza di un nuovo SMS ¹  pagina 82. Lampeggiante: Memoria SMS piena.
	Il microfono è in modalità silenziamento  pagina 70.
	Costante: Il collegamento con la stazione base è buono. Lampeggiante: Il collegamento con la stazione base si interrompe. Avvicinarsi alla stazione base.

¹ **SMS: Short Message Service** = Servizio per l'invio di messaggi di testo brevi.

Modalità di stand-by

In tutte le descrizioni del presente manuale di istruzioni si considera l'unità portatile in modalità di stand-by. Per passare alla modalità di stand-by, premere il tasto .

Modalità di risparmio energetico

Trascorso un breve intervallo in modalità di stand-by, l'unità portatile passa in modalità di risparmio energetico. Fatto questo, il display non è più illuminato. Premendo un tasto qualsiasi, l'apparecchio passa in modalità di stand-by.

Tasti di navigazione

I tasti softkey (4) e (17) sono programmati con funzioni differenti in base ai menu in cui ci si trova. Nelle presenti istruzioni per l'uso questi tasti sono denominati sempre in base ai testi di display visualizzati direttamente al di sopra.

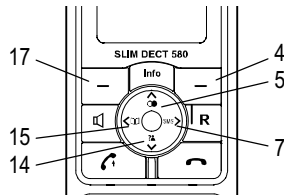









Tasto	In modalità di stand-by	Nel menu
4	- Aprire il menu principale	- Aprire il menu visualizzato
5	- Aprire l'elenco di ripetizione di chiamata	- Scorrere i menu - Modificare le impostazioni
7	- Aprire il menu SMS	- Aprire il menu visualizzato - Modificare le impostazioni
14	- Aprire l'elenco chiamate	- Scorrere i menu - Modificare le impostazioni

15	- Aprire la rubrica telefonica	- Tornare indietro di un livello - Modificare le impostazioni
17	- Compiere chiamate interne	- Interrompere procedure di programmazione e memorizzazione - Tornare indietro di un livello

Navigazione nel menu

I differenti menu consentono di raggiungere tutte le funzioni del telefono. Il percorso da seguire per giungere alla funzione desiderata è indicata dalla struttura di menu  pagina 77.

Menu	Aprire il menu principale
 o 	Selezionare il sottomenu desiderato
OK	Aprire il sottomenu
 o 	Selezionare la funzione desiderata
OK	Aprire la funzione
 o 	Selezionare l'impostazione desiderata
	La tastiera consente di inserire numeri o lettere
OK	Confermare le immissioni
Indiet	Tornare indietro di un livello
	Interrompere le procedure di programmazione/memorizzazione, modalità di stand-by



Ogni singolo processo si interrompe automaticamente se entro 30 secondi non si procede con una immissione.

Informazioni introduttive

Creare voci nella rubrica telefonica - Esempio

La navigazione nei menu e la procedura da seguire per inserire nuove voci è indicata a titolo esemplificativo in **Creare voci nella rubrica telefonica**. Si consiglia di seguire quanto riportato nell'esempio per tutte le altre impostazioni che si desiderano compiere.



Aprire la rubrica telefonica

Opzion

Selezionare



In assenza di voci nella rubrica telefonica, il passo "Opzion" è saltato automaticamente.



o



OK

Selezionare e confermare la funzione



Immettere un nome e proseguire



Immettere un numero di chiamata e proseguire



o



OK

Selezionare un gruppo e confermare

5 Compiere telefonate

Ricevere una chiamata

,  o  Ricevere una chiamata

Concludere una chiamata

 o  Concludere una chiamata

Attivare e disattivare l'unità portatile

Allo scopo di non sollecitare troppo le batterie ricaricabili è possibile spegnere l'unità portatile.

2 sec.  , **Si** Disattivare l'unità portatile



4 sec.  Inserire l'unità portatile

Compiere telefonate

 Inserire un numero di chiamata (max. 24 cifre)

Cancel In caso di immissione errata, cancellare l'ultima cifra



 Selezionare un numero di chiamata

 È altresì possibile premere prima il tasto di chiamata  /tasto di vivavoce  e ottenere così il segnale di libero. Le cifre immesse per la composizione del numero di chiamata desiderato sono immediatamente selezionate. Nel corso di una simile chiamata non è possibile eseguire la correzione di singole cifre che compongono il numero di chiamata.

Ripetizione di chiamata

Il telefono memorizza i 20 numeri di chiamata selezionati per ultimo in un elenco di ripetizione di chiamata. Ulteriori informazioni  pagina 80.



 Aprire l'elenco di ripetizione di chiamata

 o  ,  Selezionare una voce e instaurare un collegamento

Richiamare una telefonata ricevuta

Il telefono memorizza 30 chiamate in un apposito elenco chiamate  pagina 80.



 Aprire l'elenco chiamate

 o  ,  Selezionare una voce e instaurare un collegamento

Selezionare numeri di chiamata dalla rubrica telefonica

Per fare questo è necessario aver precedentemente memorizzato dei numeri nella rubrica telefonica  pagina 68 e 79.

 Aprire la rubrica telefonica

 o  ,  Selezionare una voce e instaurare un collegamento

Compiere chiamate interne¹

Condurre chiamate interne



Per condurre telefonate interne gratuite bisogna aver registrato due o più unità portatili (UP1, UP2, ...) presso la stazione base.

UP1: **Intern** ,
 o  , **OK** Selezionare il numero di chiamata interno dell'unità portatile desiderata

UP2:  Accettare una telefonata interna presso l'altra unità portatile

UP1 / UP2:  Concludere la telefonata interna

Trasferire internamente chiamate esterne

UP1: **Intern** ,
 o  , **OK** Selezionare con chiamata esterna in corso il numero interno

UP2:  Accettare una telefonata interna presso l'altra unità portatile



UP1:  Trasferire la telefonata

¹ Per compiere telefonate interne sono necessarie minimo due unità portatili  "Verificare il contenuto della confezione" a pagina 63.

Compiere telefonate

Riscontro / Chiamata in attesa

Durante lo svolgimento di una chiamata esterna è possibile chiamare un'altra unità portatile allo scopo di consultarsi o eseguire un riscontro. Mentre è in corso la conversazione con l'interlocutore interno, la chiamata esterna è trattenuta. La procedura può essere ripetuta a piacere.



UP1: **Intern**,
 o , **Dir.** Selezionare con chiamata esterna in corso il numero interno

UP2:  Accettare una telefonata interna presso l'altra unità portatile

UP1: **Attesa** Cambiare il partner di chiamata

Condurre chiamate a conferenza

Questa funzione consente di condurre una conferenza con una chiamata esterna ed un altro interlocutore interno.

UP1: **Intern**,
 o , **Dir.** Selezionare con chiamata esterna in corso il numero interno

UP2:  Accettare una telefonata interna presso l'altra unità portatile

UP1: **Conf** Avviare una conferenza

UP1: **Singol** Viene proseguita solo la chiamata interna

UP1 / UP2:  Concludere la chiamata in conferenza

Impostare il volume del ricevitore

Il volume è regolabile durante lo svolgimento di una chiamata in 5 livelli.

 o  Selezionare il volume desiderato

Visualizzazione della durata di conversazione

Durante lo svolgimento di una chiamata, la durata della telefonata è visualizzata in ore, minuti e secondi.

Funzione vivavoce

Utilizzare questa funzione per ascoltare il partner di chiamata attraverso l'altoparlante.

 Attivare la funzione vivavoce

 Disattivare la funzione vivavoce

Silenziamento del microfono nell'unità portatile

È possibile attivare e disattivare il microfono dell'unità portatile con chiamata telefonica in corso.

 Disinserire il microfono (silenziamento)

 Inserire il microfono

Blocco tastiera

Il blocco tastiera impedisce di premere accidentalmente dei tasti.

2 sec. /# Attivare il blocco tastiera

 L'attivazione del blocco tastiera consente di ricevere telefonate in arrivo come di consueto. Numeri di chiamata d'emergenza sono selezionabili anche con blocco tastiera attivato.

2 sec. /# Disattivare il blocco tastiera

Melodia di suoneria dell'unità portatile

La melodia di suoneria può essere disinserita presso l'unità portatile.

2 sec. /△ Disattivare la melodia di suoneria

 Le chiamate sono in tal caso segnalate solo presso la stazione base e non più dall'unità portatile.

2 sec. /△ Attivare la melodia di suoneria

Cercare l'unità portatile (funzione di paging)

Avendo perso d'occhio la propria unità portatile è possibile ritrovarla facilmente grazie all'emissione di un tono di ricerca.

  Avviare il tono di ricerca

 o  Interrompere il tono di ricerca

6 Rubrica telefonica / Elenco chiamate

Rubrica telefonica

Nella rubrica telefonica è possibile memorizzare 200 numeri di chiamata con rispettivi nomi.

Nomi possono essere composti da massimo 15 lettere, numeri di chiamata da massimo 24 cifre.

- Assegnare a tutti i numeri di chiamata sempre un prefisso in modo da poter riconoscere anche una chiamata urbana in arrivo ed abbinarla ad una voce presente nella rubrica telefonica.
- Con capacità di memoria esaurita, il display indica "Rubrica piena" non appena si volesse procedere con un'ulteriore immissione. Per poter disporre di nuovo spazio memoria, cancellare prima una voce già presente.
- Le voci della rubrica telefonica sono elencate in ordine alfabetico. Per accedere direttamente alla voce della rubrica telefonica desiderata, premere la lettera iniziale corrispondente.

Immettere nomi

I tasti numerici riportano altresì delle lettere. Premendo ripetutamente il relativo tasto si ha modo di selezionare lettere, cifre e caratteri speciali.



Per immettere la stessa lettera una seconda volta, premere la rispettiva lettera. Attendere fino a quando il cursore si sia spostato di una posizione. Immettere quindi la lettera una seconda volta.

Come

- creare voci della rubrica telefonica,
- modificare voci della rubrica telefonica,
- cancellare voci della rubrica telefonica e
- impostare i tasti per la selezione rapida

è riportato nella struttura menu "Rubrica telefonica" ➔ pagina 79.

¹ **CLIP:** Calling Line Identification Presentation = Visualizzazione del numero telefonico del chiamante.

Selezione del gruppo

Le voci della rubrica telefonica possono essere abbinare ad un gruppo con le specifiche individuali rispettivamente impostate.

Come

- abbinare le proprie voci ad un gruppo,
- modificare nomi di gruppo e
- assegnare melodie

è riportato nella struttura menu "Rubrica telefonica" ➔ pagina 79.

Elenco chiamate

All'interno dell'elenco chiamate è possibile memorizzare in tutto 30 numeri telefonici.



La visualizzazione del numero di chiamata (**CLIP¹**) è un servizio aggiuntivo del proprio gestore di rete telefonica. Nel caso in cui il gestore della rete telefonica supporti il servizio, sul display del telefono è visualizzato il numero di chiamata. Per maggiori dettagli a riguardo, rivolgersi al proprio gestore di rete telefonica.

Come

- ottenere la visualizzazione di numeri di chiamata dall'elenco chiamate,
- salvare numeri di chiamata dall'elenco chiamate nella rubrica telefonica e
- cancellare numeri di chiamata dall'elenco chiamate

è riportato nella struttura menu "Elenco chiamate" ➔ pagina 80.

Numeri di chiamata speciali

È possibile memorizzare dieci tra i numeri di chiamata ritenuti più importanti. Le voci sono in tal caso automaticamente disponibili presso tutte le unità mobili.

Come

- ottenere la visualizzazione delle voci,
- modificare voci e
- cancellare voci

è riportato nella struttura menu "Numeri di chiamata speciali"

➔ pagina 80.

Segreteria telefonica

7 Segreteria telefonica

Esercizio presso l'unità portatile



La segreteria telefonica è dotata di guida parlata. Si consiglia di osservare le istruzioni e indicazioni riportate qui di seguito.

Aprire il menu impostazioni

Le impostazioni della segreteria telefonica sono eseguite tramite unità portatile pagina 77.

Attivare / Disattivare la segreteria telefonica

La segreteria telefonica può essere attivata/disattivata tramite unità portatile pagina 77.

Impostare la lingua

L'uscita voce della segreteria telefonica è in inglese e non è modificabile.

Impostare data e ora

Ogni volta che il dispositivo riproduce un messaggio viene altresì annunciato il giorno della settimana e l'ora in cui il messaggio è stato ricevuto. Impostare la data e l'ora pagina 79.

Durata di registrazione massima

La segreteria telefonica memorizza fino a 59 messaggi. La durata di registrazione massima è di 15 minuti. La lunghezza che un singolo messaggio può raggiungere in sede di registrazione è impostabile pagina 77. Non appena la capacità di memoria risulta esaurita non è più possibile registrare dei messaggi nuovi.

Ritardo nell'accettazione di chiamate

Si ha modo di scegliere tra un numero compreso da 2 a 8 squilli di chiamata. In più è possibile servirsi dell'impostazione Mod risparmio per un'interrogazione a distanza/interrogazione preliminare senza addebito di scatti. La funzione di interrogazione a distanza/interrogazione preliminare gratuita consente di verificare la presenza di nuovi messaggi sulla propria segreteria telefonica.

- Se ci sono messaggi nuovi sulla segreteria telefonica, l'apparecchio accetta la telefonata al più tardi dopo 2 segnalazioni di chiamata.
- Se non ci sono messaggi nuovi sulla segreteria telefonica, l'apparecchio accetta la telefonata solo dopo 4 segnalazioni di

chiamata. Riagganciare prima del 4° squillo. In tal modo si evita l'addebito di scatti telefonici.

Ulteriori informazioni sull'interrogazione a distanza pagina 73.

Intercettare chiamate in arrivo

È possibile ascoltare chiamate in arrivo senza bisogno di accettare la chiamata.

Si	Attivare l'intercettazione
Fine	Disattivare l'intercettazione

Accettare una chiamata

Anche se la segreteria telefonica ha già risposto ad una chiamata è comunque possibile riprendere la telefonata. La registrazione del messaggio viene in tal caso interrotta.

	Rispondere ad una chiamata
--	----------------------------

Selezionare la modalità annuncio

La segreteria telefonica offre due messaggi di annuncio preimpostati. Dopo il messaggio di annuncio "Con registr" è possibile lasciare un messaggio. Il messaggio di annuncio "Senza reg" è un messaggio di solo annuncio che non prevede la possibilità di lasciare un messaggio. Entrambi i messaggi di annuncio possono essere sostituiti da messaggi individuali. Non appena la memoria della segreteria telefonica è piena, l'apparecchio riproduce automaticamente il messaggio di annuncio "Senza reg". Ulteriori informazioni pagina 77.

Registrare / Cancellare degli annunci





Registrare un annuncio

Prima di poter registrare un annuncio, scegliere la modalità di annuncio (Con registr/Senza reg) per la quale si desidera compiere la registrazione. La lunghezza dell'annuncio personalizzato non deve superare i 60 secondi.

Cancellare l'annuncio personale e fare ritorno all'annuncio standard



Cancellando l'annuncio personalizzato viene automaticamente riattivato l'annuncio standard. Ulteriori informazioni pagina 77.

Aprire il menu messaggi

Menu	Aprire il menu principale
 o 	
Segreteria tel , OK	Selezionare e confermare il sottomenu
 o 	
Riproduci msgg , OK	Selezionare e confermare il menu messaggi

Funzioni a tasti nel menu messaggi

La seguente tabella offre una panoramica delle funzioni e dei rispettivi tasti all'interno del menu messaggi.





Tasto	Funzioni
	Riprodurre tramite altoparlante
 o 	Impostare il volume
Pausa	Interrompere/Proseguire la riproduzione di messaggi
4	Ripetere il messaggio
2 x 4	Riprodurre il messaggio precedente
5 o Cancel	Cancellare il messaggio durante la riproduzione
6	Riprodurre il messaggio successivo
	Uscire dal menu messaggi e fare ritorno alla modalità di stand-by

Riprodurre messaggi registrati

I messaggi registrati sono riprodotti nell'ordine in cui sono registrati. Ogni volta che viene riprodotto un messaggio, l'apparecchio indica il giorno della settimana e l'ora di chiamata.

Cancellare tutti i messaggi vecchi

Sono cancellati tutti i messaggi già riprodotti.

Menu	Aprire il menu principale
 o 	
Segreteria tel , OK	Selezionare e confermare il sottomenu
 o 	
Cancella msgg , OK	Selezionare e confermare la funzione
Si / No	Selezionare

 Messaggi cancellati non possono essere ripristinati!



Interrogazione a distanza

È dato modo di chiamare la propria segreteria telefonica per ascoltare messaggi ricevuti e compiere una serie di funzioni accessorie. Requisito per questa operazione è un telefono abilitato alla selezione a toni. L'interrogazione a distanza deve risultare inserita  pagina 77.

Codice PIN per l'interrogazione a distanza

La configurazione iniziale del codice PIN è "0000". Si consiglia di modificare il codice PIN "0000" impostato in fabbrica. Modificare il codice PIN  pagina 77.

Avviare l'interrogazione a distanza

	Selezionare il proprio numero di chiamata
* , 	Premere durante la riproduzione dell'annuncio ed immettere il codice PIN

 In caso di immissione errata, l'annuncio della segreteria telefonica è nuovamente riprodotto. Alla ripetuta immissione del codice PIN errato il collegamento è interrotto automaticamente.

A questo punto è dato modo di compiere ulteriori funzioni  Tabella Funzioni tasti dell'interrogazione a distanza.

Segreteria telefonica

Attivazione a distanza della segreteria telefonica



Selezionare il proprio numero di chiamata



Avendo dimenticato di inserire la segreteria telefonica, la chiamata è ricevuta solo dopo 10 squilli.



Premere durante la riproduzione dell'annuncio ed immettere il codice PIN

0

Attivare / Disattivare la segreteria telefonica

A questo punto è dato modo di compiere ulteriori funzioni  Tabella Funzioni tasti dell'interrogazione a distanza.

Funzioni a tasti dell'interrogazione a distanza



L'interrogazione a distanza è interrotta automaticamente se entro 8 secondi non si procede con una immissione.

La seguente tabella offre una vista generale delle rispettive funzioni dei singoli tasti.

Tasto	Funzioni
1	Riprodurre il menu ausiliario
2	Avviare la riproduzione di tutti i messaggi
3	Avviare la riproduzione dei messaggi nuovi
4	Ripetere il messaggio in corso
2 x 4	Riprodurre il messaggio precedente
5	Cancellare il messaggio durante la riproduzione
6	Riprodurre il messaggio successivo
7	Selezionare la modalità di annuncio: "Con registr" o "Senza reg"
8	Riprodurre il messaggio di annuncio attualmente impostato
9	Registrare il messaggio di annuncio "Con registr" o "Senza reg"
0	Attivare / Disattivare la segreteria telefonica
#	Concludere la registrazione del messaggio di annuncio
	Riagganciando il ricevitore l'interrogazione a distanza è conclusa.

Esercizio presso la base



La segreteria telefonica è dotata di guida parlata. Si consiglia di osservare le istruzioni e indicazioni riportate qui di seguito.

Attivare / Disattivare la segreteria telefonica



Attivare / Disattivare la segreteria telefonica

Impostare il volume

Il volume è impostabile in 5 livelli.



Impostare il volume

Riprodurre / Cancellare messaggi registrati

Riprodurre un messaggio

I messaggi registrati sono riprodotti nell'ordine in cui sono registrati. Ogni volta che viene riprodotto un messaggio, l'apparecchio indica il giorno della settimana e l'ora di chiamata.



Riprodurre messaggi



Interrompere la riproduzione



Ripetere il messaggio



Messaggio precedente



Messaggio successivo

Cancellare un messaggio



Riprodurre il messaggio da cancellare



Cancellare con riproduzione in corso

Cancellare tutti i messaggi

Sono cancellati tutti i messaggi già riprodotti.



Avviare la procedura di cancellazione



Cancellare i messaggi

Display della segreteria telefonica

Il display della segreteria telefonica visualizza lo stato dell'apparecchio.

--

Segreteria telefonica disinserita

0-59

Segreteria telefonica inserita, numero di messaggi registrati



In presenza di nuovi messaggi, sul display lampeggia l'indicazione relativa ai messaggi salvati.

rA

È visualizzato compiendo impostazioni alla segreteria telefonica tramite unità mobile.

rE

È visualizzato con registrazione di messaggio in corso.

Impianti telefonici interni / Servizi aggiuntivi

8 Impianti telefonici interni / Servizi aggiuntivi

Tasto R in impianti telefonici interni

Avendo collegato il telefono ad un impianto telefonico interno, il **tasto R** consente di accedere a tutte le altre funzioni disponibili come per es. trasferimento di chiamata e funzione di chiamata automatica. Si prega di consultare le istruzioni per l'uso del proprio impianto telefonico interno per individuare il tempo flash da impostare al fine di poter usufruire di queste funzioni. Il rivenditore autorizzato è in grado di indicare se il telefono acquistato funzionerà senza alcun problema nel proprio impianto telefonico interno. Il tempo flash è impostato nel menu. A pagina 78 è indicata la posizione da scorrere nel menu.

Cifra per il segnale dalla centrale

In presenza di impianti telefonici interni è necessario selezionare un determinato numero prima di ottenere un segnale di libero che indica la disponibilità della linea di collegamento di rete. La cifra per il segnale dalla centrale è memorizzabile. Non appena il telefono riconosce la cifra per il segnale dalla centrale davanti ad un numero di chiamata inserito, l'apparecchio prevede **automaticamente** una **pausa di selezione** dopo la cifra per il segnale di linea libera. Impostare la cifra per il segnale dalla centrale ☞ pagina 78.

Inserire manualmente la pausa di selezione

L'immissione di una **pausa di selezione** dopo la cifra per il segnale dalla centrale è eseguibile **manualmente** e **consente di proseguire la selezione del numero senza dover attendere il segnale di libero**.

2 sec. Immettere una pausa di selezione

Dopo la cifra per il segnale dalla centrale si procede, trascorso un determinato intervallo di tempo, con la selezione del numero di chiamata vero e proprio.



La pausa di selezione è anche programmabile in sede di immissione di numeri di chiamata nella segreteria telefonica [memoria dei numeri di chiamata].

Tasto R e servizi aggiuntivi

Il telefono supporta servizi aggiuntivi messi a disposizione dal proprio gestore di rete telefonica come per es. le funzioni di chiamata in attesa, avviso di chiamata e chiamata a conferenza. Il **tasto R** consente di accedere

a questi servizi aggiuntivi. Si prega di consultare il proprio gestore di rete telefonica per ottenere informazioni sul tempo flash necessario all'utilizzo dei servizi aggiuntivi. Rivolgersi al proprio gestore di rete telefonica per ottenere l'abilitazione ai servizi aggiuntivi. Il tempo flash è impostato nel menu. A pagina 78 è indicata la posizione da scorrere nel menu.

Visualizzazione del numero di chiamata (CLIP¹)



La visualizzazione del numero di chiamata è un servizio aggiuntivo offerto dal proprio gestore di rete telefonica. Si consiglia di rivolgersi al proprio gestore di rete telefonica per ricevere maggiori informazioni a riguardo.

A condizione che il collegamento telefonico disponga di questa funzione, l'apparecchio visualizza il numero telefonico del chiamante non appena il telefono squilla. Nel caso in cui il chiamante abbia soppresso la trasmissione del proprio numero di chiamata, appare un'apposita indicazione. Se il numero di chiamata non è visualizzabile, questo non sarà memorizzato nell'elenco chiamate.

Segreteria telefonica integrata nella rete telefonica

Sono numerosi i gestori di rete telefonica che offrono come servizio aggiuntivo una segreteria telefonica integrata nella stessa rete. Se il gestore mette a disposizione una segreteria telefonica all'interno della propria rete telefonica, un simbolo informa sulla presenza di nuovi messaggi (VMWI²). Questa funzione è disponibile solo nel caso di abilitazione al servizio da parte del gestore di rete telefonica. Per maggiori dettagli a riguardo, rivolgersi al proprio gestore di rete telefonica.

Avendo attivato questo servizio aggiuntivo e in presenza di nuovi messaggi sulla propria segreteria telefonica in rete, è dato modo di disattivare manualmente nel menu la visualizzazione senza ascoltare il messaggio. A pagina 78 è indicata la posizione da scorrere nel menu.

Msg Wait Off

OK

Disattivare la visualizzazione

¹ **CLIP**: Calling Line Identification Presentation = Visualizzazione del numero telefonico del chiamante.

² **VMWI**: Visual Message Waiting Indication = Segnalazione ottica di nuovi messaggi.

9 Struttura di menu

Menu principale

Nel menu principale si giunge premendo il tasto softkey **Menu**. La procedura da seguire per scorrere all'interno del menu ed eseguire immissioni è riportata a pagina 67.

SMS¹

Scrivi SMS		Opzion	Invia	Inserisci num	Invia
				Opzion	Rubrica telef
					Ripet chiamata
					Elenco chiamat
			Salva		
			Modello		
Ricevut ²					
Inviati					
Modello					
Impostazioni	Centro SMS			Centro SMS 1 - 4	
	Servizio invio			Centro SMS 1/2	
	Allarme SMS			On/Off	

Segreteria tel

Riproduci msgg		
Cancella msgg		
Segret ON/OFF	On/Off	
Testo annuncio	Nuovo annuncio	Con registr/Senza reg
	Ascolta annun	Con registr/Senza reg
Impostazioni	Mod segreteria	Con registr/Senza reg
	Ritardo	Mod risparmi
		2 Chiamate - 8 Chiamate
	Tempo registr	30s - 180s
	Intercetta	On/Off
Accesso remoto	Off	
	On	Imm vecch PIN →
		→ Imm nuovo PIN →
		→ Ripeti PIN

¹ Ulteriori informazioni sui messaggi di testo SMS ➔ pagina 82.



² Sono memorizzati fino a 30 messaggi.

Struttura di menu





Audio

Selez toni	Esterno	Melodia 1 - 15
	Interno	Melodia 1 - 15
	Vol suoneria	Off, 1 - 5
	Silenz	Off/Beep
Suono avviso	Suono tasti	On/Off
	Tono riscontro	On/Off
	Batter scarica	On/Off
	Fuori tiro	On/Off

Impostazioni

Impost portat	Chiam diretta	PIN sistema ¹	Off
			On 
	Selez base	Base 1	
	Display	Contrasto 1 - 8	
		Nome portatile 	
	Lingua	Deutsch/English/ Italiano/Français	
	Risposta dir	On/Off	
	Selez portat	Base 1 - 4	PIN sistema
	Deselez portat	PIN sistema	
	Reset portatil	Si/No	

¹ Il PIN di sistema è impostato in fabbrica su "0000".

Imposta base	Selez toni	Melod suoneria	Melodia 1 - 5
		Vol suoneria	Off, 1 - 5
	Priorità port ²	Tutti i portat	
		Seleziona port	Portatile 1 - 5 
			 2/4/6/8
	Proc selezione	Toni/Impulsi	
	Tempo flash	80ms - 800ms	
	Msg Wait Off		
	PIN sistema	Imm vecch PIN	Imm nuovo PIN 
			 Ripeti PIN
Prefisso			
Mode ECO	On/Off		
Reset sistema ³	Immetti PIN	Si/No	



² Qui è possibile impostare se una chiamata in arrivo dovrà essere segnalata presso tutte le unità portatili selezionate all'interno dell'impianto telefonico o se invece dovrà squillare solo una determinata unità portatile.



³ **Attenzione:** Tutti i messaggi presenti, anche messaggi nuovi/non riprodotti, sono cancellati in caso di un reset del sistema!

Struttura di menu



↓	Ora / Allarme	Data/ora	Formato ora	12 ore/24 ore
			Formato data	mm/gg o gg/mm
			Immetti ora	
			Immetti data	
	Allarme		Immetti ora	
		Allarme On/Off	Off	
			Una volta	
			Giornalment	
		Melod suoneria	Melodia 1 - 15	

Rubrica telefonica

 scorrere  /  per selezionare la voce desiderata

Opzion	Nuovo inserim.	Nome portatile	 ↓
		Numero	 ↓
		Selez gruppo	Nessuno
		Famiglia	
		Ufficio	
		Amici	
		Servizi	
		VIP	
		Altri	
		Generale	

↓

↓	Modifica voce	Nome portatile	 ↓
		Numero	 ↓
		Selez gruppo	Nessuno
		Famiglia	
		Ufficio	
		Amici	
		Servizi	
		VIP	
		Altri	
		Generale	
	Vedi	Nome portatile	↓
		Numero	↓
		Melodia gruppo	
	Copia	Portatile 1, 2, ..	
	Copia tutti	Portatile 1, 2, ..	
	Cancella voce	Si/No	
	Cancella tutti	Si/No	
	Occup memoria		
	Modif gruppo	Selezionare il gruppo	Disattivo
	Selez rapida	Tasto 2 - 9	Melod suoneria Selezionare la voce



Se il tasto di selezione rapida risultasse già occupato, la rispettiva voce è visualizzata.



Struttura di menu

Numeri di chiamata speciali

scorrere / per selezionare la voce desiderata

Opzion	Vedi	Nome portatile
		Numero
	Cancella voce	
	Modifica voce	Nome portatile <input type="button" value="☰"/> <input type="button" value="▼"/>
		Numero <input type="button" value="☰"/>
	Cancella tutti	Si/No

Elenco chiamate

scorrere / per selezionare la voce desiderata

Opzion	Vedi		
	Cancel		
	Cancella tutti	Si/No	
	Chiama numero	Opzion	Rubrica telef
			Ripet chiamata
			Elenco chiamat
	Salva numero	vedi Nuovo inserim.	
	Impostazioni	Tipo chiamata	Tutte chiam
			Chiam perse
	Allarme elenco	On/Off	

SMS

vedi SMS pagina77.

Ripetizione di chiamata

scorrere / per selezionare la voce desiderata

Opzion	Cancel	Si/No	
	Cancella tutti	Si/No	
	Chiama numero	Opzion	Rubrica telef
			Ripet chiamata
			Elenco chiamat
	Salva numero	vedi Nuovo inserim.	

10 Funzioni speciali

Procedura di selezione

Il presente telefono funziona sia all'interno di sistemi telefonici analogici (procedura di selezione a impulsi), sia se integrato in moderni sistemi telefonici digitali (procedura di selezione a toni). La procedura di selezione è impostata nel menu. A pagina 78 è indicata la posizione da scorrere nel menu.

Selezione a toni temporanea

Qualora fosse possibile utilizzare il telefono soltanto con la procedura di selezione a impulsi, non sarà necessario rinunciare ai vantaggi della procedura di selezione a toni (ad es. per l'interrogazione della segreteria telefonica dalla rete telefonica). Con chiamata in corso è possibile passare temporaneamente alla procedura di selezione a toni.

2 sec. ***** Premere con chiamata in corso

A conclusione della chiamata il telefono passa di nuovo automaticamente alla procedura di selezione a impulsi.

Allarme

Una volta attivata la funzione, la propria unità portatile rilascia un allarme all'orario precedentemente impostato. A pagina 79 è indicata la posizione da scorrere nel menu.

Chiamata diretta

La funzione consente di memorizzare un numero telefonico selezionato automaticamente non appena si preme un tasto qualsiasi del telefono (tranne **Opzion**). A pagina 78 è indicata la posizione da scorrere nel menu.

Selezione rapida

È necessario aver memorizzato numeri telefonici sotto forma di numeri di selezione rapida. A pagina 79 è indicata la posizione da scorrere nel menu.





2 sec. **2** a **9** Premere il tasto di selezione rapida desiderato

Il numero di chiamata memorizzato è direttamente selezionato.



Copiare voci della rubrica telefonica

Le voci all'interno della rubrica telefonica sono trasferibili da un'unità portatile all'altra.

Copiare una singola voce

	Aprire la rubrica telefonica
	Selezionare la voce desiderata
Opzion	Richiamare l'opzione
 , OK	Selezionare e confermare "Copia"
 , OK	Selezionare e confermare l'unità portatile
Si / No	Compiere la propria selezione presso l'unità portatile ricevitrice

Copiare tutte le voci

	Aprire la rubrica telefonica
Opzion	Richiamare l'opzione
 , OK	Selezionare e confermare "Copia tutti"
 , OK	Selezionare e confermare l'unità portatile
Si / No	Compiere la propria selezione presso l'unità portatile ricevitrice



11 SMS

Requisiti SMS

L'allacciamento telefonico deve disporre della caratteristica funzionale **CLIP**¹. Informarsi presso il gestore delle rete telefonica se l'allacciamento telefonico è abilitato alla caratteristica funzionale richiesta. Per poter usufruire del servizio **SMS**² può rendersi necessaria la precedente abilitazione al servizio presso il gestore della rete.

- L'invio di SMS non è possibile da qualsiasi tipo di impianto telefonico interno.



Volendo compiere l'invio di un SMS da un impianto telefonico interno, memorizzare sull'unità portatile prima la cifra per il segnale dalla centrale richiesto dal proprio impianto telefonico, quindi il numero del centro di servizi.

- L'invio di SMS non è attualmente possibile in caso di collegamenti call by call.
- L'invio di messaggi SMS è soggetto a costi supplementari.
- Se il ricevitore non utilizza un servizio SMS o se il rispettivo telefono non è abilitato alla ricezione di SMS, il messaggio SMS è inoltrato sotto forma di messaggio vocale.
- Il calcolo delle rispettive spese avviene da parte del proprio gestore di rete telefonica.

Centro di servizio SMS

La distribuzione dei messaggi SMS è eseguita da parte di un centro di servizi. Per inviare messaggi di testo SMS è necessario programmare il numero del centro di servizi nella propria unità portatile ➤ pagina 77. Il numero del centro di servizio necessario è comunicato dal provider prescelto che provvederà altresì ad indicare la procedura da seguire per l'abilitazione al servizio SMS.



Il presente telefono è già predisposto per l'invio di messaggi di testo SMS. Alcuni numeri di centri SMS risultano già programmati sull'unità portatile. Basta attivare il centro SMS desiderato nel menu SMS ➤ pagina 77.

Centro SMS 1

Swisscom: 0622100000

Centro SMS 2

Cablecom: 0435375370

Immettere testi

Sui tasti a cifra si trovano altresì delle lettere per l'immissione di testi. Premendo ripetutamente il relativo tasto si ha modo di selezionare lettere, cifre e caratteri speciali. La navigazione da seguire per scrivere degli SMS è indicata nella struttura menu ➤ pagina 77.



Passare da lettere maiuscole a lettere minuscole e viceversa

Cancel

Cancellare l'ultima posizione

tenere Cancel

Cancellare tutto

Modelli per SMS

Sono disponibili 5 modelli preprogrammati ➤ pagina 77.

Segnale di avviso SMS (allarme)

La ricezione di un messaggio di testo SMS nuovo è segnalato acusticamente con un segnale di avviso. Il segnale è attivato o disattivato tramite menu. A pagina 77 è indicata la posizione da scorrere nel menu.

¹ **CLIP**: Calling Line Identification Presentation = Visualizzazione del numero telefonico del chiamante.

² **SMS**: Short Message Service = Servizio per l'invio di messaggi di testo brevi.

12 Ampliamento del sistema telefonico



Lo standard internazionale **GAP**¹ regola la compatibilità di unità portatili e stazioni base di costruttori differenti. In tal modo è possibile adoperare apparecchi SWITEL in combinazione con apparecchi di altri costruttori all'interno di un unico sistema telefonico. Può comunque anche verificarsi la mancata disponibilità di alcune funzioni.



Maggior numero di unità portatili

È possibile registrare complessivamente fino a 5 unità portatili presso la propria stazione base.

Registrazione di unità portatili

Prima di registrare un'unità portatile, passare con la stazione base alla modalità di registrazione.

tenere  fintanto che  lampeggia Modalità di registrazione avviata

Procedere a questo punto con la registrazione dell'unità portatile  pagina 78. Utilizzare per la registrazione il codice PIN attualmente impostato  pagina 78.

Una volta eseguita la selezione, all'unità portatile è assegnato un numero di chiamata interno. Questo numero di chiamata interno è visualizzato sul display.



Per registrare unità portatili di altri costruttori, leggere prima le rispettive istruzioni per l'uso.

Deselezione di unità portatili



Ogni unità portatile è in grado di deselezionare se stessa o altre unità dalla presente stazione base. In tal caso, nel display dell'unità portatile deselezionata è visualizzata l'indicazione Selezionare !.

Unità portatili sono deselezionate nel menu. A pagina 78 è indicata la posizione da scorrere nel menu.

¹ **GAP: Generic Access Profile** = Standard per l'interazione di unità portatili e stazioni base di altri costruttori differenti.

Maggior numero di stazioni base

La portata della propria unità portatile può essere aumentata registrando l'apparecchio ad un numero maggiore di stazioni base. È possibile registrarsi contemporaneamente presso 4 stazioni base differenti. Ogni stazione base necessita di una propria presa telefonica. Si può trattare di allacciamenti con lo stesso o differente numero di chiamata.

Selezione dalla base  pagina 78.



Per chiamate in corso non è invece possibile compiere un trasferimento da una stazione base all'altra.



La portata del sistema telefonico può essere aumentata disattivando la modalità ECO  pagina 78 (Mode ECO → Off).

In presenza di problemi

13 In presenza di problemi

Hotline di assistenza

In presenza di problemi con il telefono, seguire le indicazioni riportate qui di seguito. In caso di problemi tecnici è possibile rivolgersi alla nostra hotline di assistenza tecnica chiamando al numero 0900 00 1675 valido per la Svizzera (spese da rete Swisscom alla data di stampa: CHF 2.00 / min). In caso di reclami entro il periodo di garanzia, rivolgersi al rivenditore autorizzato. Il periodo di garanzia ricopre 2 anni.

Domande e risposte

Domande	Risposte
Non è possibile instaurare un collegamento con la stazione base	<ul style="list-style-type: none">- Verificare se la registrazione alla stazione base è stata eseguita con il codice PIN corretto ☞ pagina 78.
Non è possibile condurre una chiamata telefonica	<ul style="list-style-type: none">- Il telefono non è collegato correttamente oppure presenta un guasto. Utilizzare esclusivamente il cavo di collegamento telefonico fornito.- Provare con un altro telefono se l'allacciamento telefonico in questione è funzionante.- L'alimentatore di rete non è inserito oppure si è in presenza di una caduta di tensione totale.- L'accumulatore ricaricabile è scarico o guasto.- La distanza dalla stazione base è troppo grande.- Procedura di selezione non impostata correttamente ☞ pagina 78.
Collegamento disturbato, interrotto	<ul style="list-style-type: none">- La distanza dalla stazione base è troppo grande.- Luogo di installazione della stazione base errato.

Il sistema non reagisce più	<ul style="list-style-type: none">- Ripristinare la configurazione iniziale per tutte le funzioni ☞ pagina 78.- Estrarre brevemente l'alimentatore di rete dalla presa di corrente.
L'accumulatore ricaricabile si scarica dopo pochissimo tempo	<ul style="list-style-type: none">- L'accumulatore ricaricabile è scarico o guasto.- Riporre l'unità portatile correttamente nella stazione base. Pulire le superfici di contatto su unità portatile e stazione base con un panno morbido e asciutto.- Posizionare l'unità portatile per la durata di 20 ore nella stazione base.
La visualizzazione del numero di chiamata (CLIP ¹) non funziona	<ul style="list-style-type: none">- La visualizzazione del numero di chiamata è un servizio aggiuntivo offerto dal proprio gestore di rete telefonica. Per maggiori dettagli a riguardo, rivolgersi al proprio gestore di rete telefonica.- Il chiamante ha disattivato la trasmissione del proprio numero di chiamata.
La segreteria telefonica non registra alcun messaggio	<ul style="list-style-type: none">- Assicurarsi che la segreteria telefonica sia stata collegata e inserita correttamente.- Verificare che la memoria della segreteria telefonica non sia piena. Cancellare eventuali messaggi dalla memoria ☞ pagina 77.
Non è possibile compiere un'interrogazione a distanza	<ul style="list-style-type: none">- Verificare se è stato utilizzato il codice di sicurezza corretto previsto per l'interrogazione a distanza ☞ pagina 77.- Il telefono utilizzato per compiere l'interrogazione a distanza deve passare alla procedura di selezione a toni.

¹ **CLIP:** Calling Line Identification Presentation = Visualizzazione del numero telefonico del chiamante.

14 Specifiche tecniche

Specifiche tecniche

Caratteristica	Valore
Standard	DECT¹-GAP²
Alimentazione elettrica (stazione base)	Ingresso: 220/230 V, 50 Hz Uscita: 6 V, 600 mA
Alimentazione elettrica (stazione di carica)	Ingresso: 220/230 V, 50 Hz Uscita: 6 V, 300 mA
Portata	Esterno: ca. 300 m Interno: ca. 50 m
Stand-by	fino a 100 ore
Max. durata di conversazione	fino a 10 ore
Accumulatore ricaricabile	NiMH 2.4 V 600 mAh
Procedura di selezione	Toni (DTMF) Impulsi (IWW)
Temperatura ambiente ammessa	da 10 °C a 30 °C
Umidità dell'aria relativa ammessa	da 20 % a 75 %
Funzione flash	80, 100, 120, 180, 250, 300, 600 o 800 ms

¹ **DECT**: Digital Enhanced Cordless Telecommunication = Standard per telefoni senza cavo.

² **GAP**: Generic Access Profile = Standard per l'interazione di unità portatili e stazioni base di altri costruttori differenti.

Configurazione iniziale

Unità portatile

La configurazione iniziale è ripristinata nel menu. A pagina 78 è indicata la posizione da scorrere nel menu.

Vol suoneria	5	Suono tasti	On
Melodia interna	1	Volume dell'altoparlante	3
Melodia esterna	2	Ripet chiamata	Vuoto
Batter scarica	On	Volume del ricevitore:	3
Fuori tiro	On	Lingua	Deutsch

Stazione base

La configurazione iniziale è ripristinata nel menu.

A pagina 78 è indicata la posizione da scorrere nel menu.



Attenzione: Tutti i messaggi presenti, anche messaggi nuovi/non riprodotti, sono cancellati in caso di un Reset sistema!

PIN sistema	0000	Tempo flash	100 ms
Proc selezione	Toni	Melod suoneria	1
Prefisso	Vuoto	Vol suoneria	3
Elenco chiamate	Vuoto	Mode ECO	On

Specifiche tecniche

Segreteria telefonica

Segreteria tel	On	Tempo registr	60 s
Testo annuncio	Con registr	Intercetta	On
Ritardo	Mod risparmi	Accesso remoto	On

Dichiarazione di conformità

Questo apparecchio risponde a quanto disposto dalla Direttiva UE:

1999/5/CE Direttiva concernente le apparecchiature radio, le apparecchiature terminali di telecomunicazioni e il reciproco riconoscimento della loro conformità. La conformità con la direttiva di cui sopra viene confermata dal marchio CE applicato sull'apparecchio.



Per la dichiarazione di conformità completa si prega di voler usufruire del servizio gratuito di download dal nostro sito Internet www.switel.com.

15 Consigli per la cura / Garanzia

Consigli per la cura

- Pulire le superfici degli apparecchi con un panno morbido e antipilling.
- Non utilizzare mai detergenti o solventi.

Garanzia

Gli apparecchi SWITEL sono costruiti e collaudati in osservanza dei processi di produzione più moderni. L'impiego di materiali selezionati e tecnologie altamente sviluppate sono garanti di una perfetta funzionalità e lunga durata in vita. La garanzia non viene considerata esecutiva qualora la causa del malfunzionamento dell'apparecchio è dovuta al gestore della rete telefonica oppure se questa è da attribuirsi ad un impianto telefonico interno interposto. La garanzia non si estende a batterie, accumulatori o batterie ricaricabili utilizzati all'interno degli apparecchi. Il periodo di garanzia ricopre 24 mesi a partire dalla data di acquisto.

Entro il periodo di garanzia si procederà all'eliminazione gratuita di tutti i guasti dovuti a difetti di materiale o produzione. Il diritto di garanzia cessa in caso di interventi da parte dell'acquirente o di terzi. Danni derivanti da un impiego o esercizio non conforme agli usi previsti, a naturale usura, a errato montaggio o errata conservazione, a collegamento o installazione impropri, dovuti a forza maggiore o ad altri influssi esterni non sono coperti da garanzia. In qualità di produttore ci riserviamo il diritto, in caso di reclami, di riparare o sostituire le parti difettose o di rimpiazzare l'apparecchio. Parti o apparecchi sostituiti passano di nostra proprietà. Sono esclusi diritti di risarcimento per danni qualora non siano dovuti a intenzione o colpa grave del costruttore.

Nel caso in cui il presente apparecchio dovesse ciò nonostante presentare un difetto durante il periodo di garanzia, si prega di rivolgersi esclusivamente al negozio di rivendita dell'apparecchio SWITEL assieme al relativo scontrino di acquisto. In base alle presenti disposizioni, tutti i diritti di garanzia dovranno essere fatti valere esclusivamente nei confronti del rivenditore autorizzato. Decorso il termine di due anni dalla data di acquisto e consegna dei nostri prodotti non sarà più possibile fare valere alcun diritto di garanzia.

Indice alfabetico

16 Indice alfabetico

A

Accettare una chiamata, 72
Accettazione di chiamata, 64, 69
Accettazione diretta, 64
Agganciare il ricevitore, 69
Allarme, 81
Ampliamento, 83
Annunci, 72
Attivare, 69, 72, 75
Attivazione a distanza, 74

B

Blocco tastiera, 70

C

Cancellare, 71, 72, 73, 75
Cancellare messaggi, 75
Caricare, 64
Centro di servizio, 82
Cercare, 70
Chiamata diretta, 81
Chiamata in attesa, 70
Chiamate a conferenza, 70
Chiamate interne, 69
Cifra per il segnale dalla centrale, 76
CLIP, 76
Codice PIN, 73
Compiere telefonate, 69
Concludere una chiamata, 69
Configurazione iniziale, 85
Consigli per la cura, 87
Contenuto della confezione, 63
Copiare voci della rubrica telefonica, 81
Creare, 68, 71

D

Data, 64, 72
Deselezionare, 83
Dichiarazione di conformità, 86
Disattivare, 69, 72, 75
Display, 66, 75
Domande e risposte, 84
Durata di conversazione, 70
Durata di registrazione massima, 72

E

Elementi di comando, 65
Elenco chiamate, 71
Eliminare guasti, 84
Esercizio, 66
Esercizio presso l'unità portatile, 72
Esercizio presso la base, 75

F

Funzione di richiamata, 69
Funzione vivavoce, 70
Funzioni, 81
Funzioni a tasti, 73, 74

G

Garanzia, 87

H

Hotline di assistenza, 84

I

Immissione di testi, 82
Immissione di un nome, 71
Immissione di un testo, 71
Impianti telefonici interni, 76
Indicazioni di sicurezza, 62
Info, 80
Inserire l'accumulatore ricaricabile, 64
Inserire manualmente la pausa di selezione, 76
Intercettare, 72
Interrogazione a distanza, 73

L

Lingua, 72
Lingua di display, 64

M

Melodia, 71
Melodia di suoneria, 70
Menu impostazioni, 72
Menu messaggi, 73
Menu principale, 77
Messa in funzione, 63
Messaggi, 75
Modalità annuncio, 72
Modalità di risparmio energetico, 67
Modalità di stand-by, 67
Modalità ECO, 64
Modelli per SMS, 82
Modi di scrittura, 66
Modificare, 71

N

Nomi di gruppo, 71
Numeri di chiamata speciali, 71

O

Ora, 64, 72

P

Paging, 70
Pausa di selezione automatica, 76
Problemi, 84
Procedura di selezione, 81
Procedura di selezione a impulsi, 81
Procedura di selezione a toni, 81

R

Registrare, 72, 83
Riduzione delle radiazioni, 64
Ripetizione di chiamata, 69, 80
Riprodurre, 75
Riprodurre messaggi, 73
Riscontro, 70
Risparmio di addebiti, 72
Ritardo, 72
Rubrica telefonica, 69, 71, 79, 80

S

Salvare, 68, 71
Segnale di avviso, 82
Segreteria telefonica, 72
Segreteria telefonica integrata nella rete telefonica, 76
Selezionare, 69
Selezione a toni temporanea, 81
Selezione del gruppo, 71
Selezione rapida, 71, 81
Servizi addizionali, 76
Silenziamento, 70
Silenziamento del microfono, 70
Simboli, 66
Simboli di display, 66
SMS, 82
Sollevare il ricevitore, 69
Specifiche tecniche, 85
Stato di carica dell'accumulatore ricaricabile, 64
Stazione base, 63, 65, 83
Stazione di carica, 63
Struttura di menu, 77

T

Tasti di navigazione, 67
Tasto R, 76
Trasferimento di chiamata, 69

U

Unità portatile, 65, 83

V

Visualizzazione del numero di chiamata, 71, 76
VMWI, 76
Voci della rubrica telefonica, 68, 71
Volume, 75
Volume del ricevitore, 70

1	Safety Information	92
2	Preparing the Telephone	93
4	Operating Elements	95
6	Preliminary Information	96
7	Telephoning	98
6	Phone Book / Call List	100
9	Answering Machine	101
8	PBX / Supplementary Services	105
11	Menu Structure	106
10	Special Functions	110
11	SMS - Text Messages	111
12	Extending the Telephone System	112
12	In Case of Problems	113
17	Technical Properties	114
15	Maintenance / Guarantee	116
16	Index	117

Safety Information

1 Safety Information

Please read this operating instruction manual thoroughly.

Intended use

The telephone is suitable for telephoning within a public telephone network system. Any other use is considered unintended use. Unauthorised modification or reconstruction is not permitted. Under no circumstances open the device or complete any repair work yourself.

Installation location

Prevent excessive exposure to smoke, dust, vibration, chemicals, moisture, heat and direct sunlight.

Do not use the handset in potentially explosive areas.

Power adapter plug



Attention: Only use the power adapter plug supplied because other power supplies could damage the telephone. Ensure access to the power adapter plug is not obstructed by furniture or such.

Rechargeable battery pack



Attention: Never throw batteries into a fire. Only use batteries of the same type. Pay attention to the correct polarity. Incorrect polarity of the batteries represents a risk of explosion during charging.

Power failure

The telephone cannot be used to make calls in the event of a power failure. Always keep a cord connected telephone which operates without an external power supply available in case of emergency situations.

Medical equipment



Attention: Never use the telephone in the vicinity of medical equipment. Effects on such equipment cannot be fully ruled out.

DECT¹ telephones can cause an unpleasant humming sound in hearing aids.

¹ DECT: Digital Enhanced Cordless Telecommunication = Standard for cordless telephones.

Disposal

In order to dispose of your device, take it to a collection point provided by your local public waste authorities (e.g. recycling centre). The adjacent symbol indicates that the device must not be disposed of in normal domestic waste! According to laws on the disposal of electronic and electrical devices, owners are obliged to dispose of old **electronic and electrical devices** in a separate waste container.



Batteries must be disposed of at the point of sale or at the appropriate collection points provided by the public waste authorities.



Packaging materials must be disposed of according to local regulations.

2 Preparing the Telephone

Safety information



Attention: It is essential to read the Safety Information in Chapter 1 before starting up.

Checking the package contents

The package contains:

Content	DFT 817x model			
	8171	8172 ¹	8173 ¹	8174 ¹
Base station (answering machine) with power adapter plug	1	1	1	1
Charging station with power adapter plug	-	1	2	3
Handset	1	2	3	4
Telephone connection cable	1	1	1	1
Power pack	1	2	3	4
Operating instructions	1	1	1	1

¹ Visit www.switel.com to find out whether the telephone set is already available.

Connecting the base station



Attention: Position the base station at least 1 m away from other electronic devices, otherwise there is a risk of mutual disturbance.

Connect the base station as illustrated in the diagram. For reasons of safety, only use the power adapter plug and telephone connection line supplied.

Telephone line socket

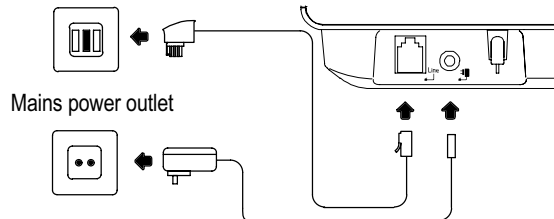

Attention: With regard to the base station with answering machine, use the power adapter plug model No. VD0600601, bearing the output data: 6 V, 600 mA.

Connecting the charging station²

Connect the charging station as illustrated in the diagram. For safety reasons, only use the power adapter plug supplied.

Mains power outlet

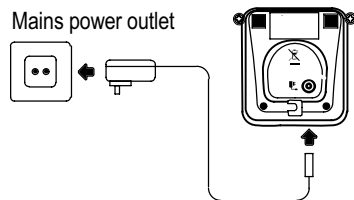

Attention: With regard to the charging station, use the power adapter plug model No. SY-06030-GS, bearing the output data: 6 V, 300 mA.

² Only applies to telephone sets with at least two handsets
 "Checking the package contents" on Page 93.

Preparing the Telephone

Inserting the battery pack

Open the battery compartment cover. Connect the plug leading from the battery pack to the corresponding socket in the battery compartment. Insert the battery pack in the battery compartment. Only use the battery pack supplied. Pay attention that the cable is not jammed. Close the battery compartment cover.

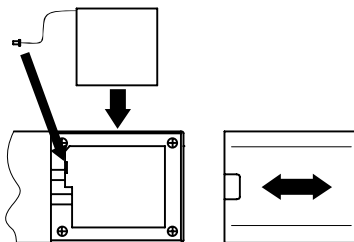

Charging the battery pack



Before the handset is used for the first time, insert it in the base station / charging station for **at least 20 hours**.

The handset warms up during the charging process. This is normal and does not represent a risk. Do not charge the handset with charging units from other manufacturers. The current **battery charge status** is indicated in the display:



Full



Half empty



Low



Empty

Setting the time and date on the handset

The time and date are set via the menu. Refer to Page 108 for the sequence of menu option selections.

Setting the display language

The display language is available in German, English, Italian and French. Set the language using the menu. Refer to Page 107 for the sequence of menu option selections.

Auto Answer

If this function is activated, an incoming call is taken when the handset is removed from the base station. The automatic answering function is activated and deactivated using the menu. Refer to Page 107 for the sequence of menu option selections.

Private branch exchanges

If you want to connect the telephone to a private branch exchange, more information is provided on Page 105.

Setting the date and time on the answering machine

The date and time are set automatically on the answering machine via the handset.

Low-radiation operation (ECO mode)



Default setting = ECO Mode → On



Both in Call mode as well as in Standby mode, the radiation is reduced considerably when ECO mode is activated as compared to standard, cordless DECT telephones.

















If necessary, you can increase the range of the telephone system by switching ECO mode off  Page 107 (ECO Mode → Off).

3 Operating Elements







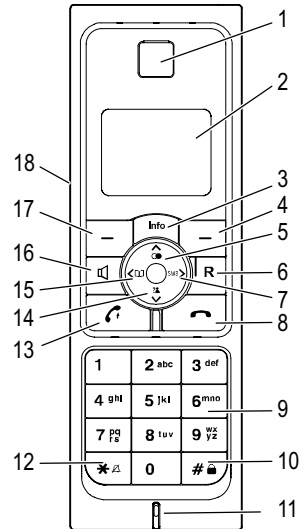



The buttons in this operating manual are subsequently depicted with a uniform contour. Therefore, slight deviations in the appearance of the symbols on the telephone buttons compared to those depicted here are possible.

Handset

- 1 Earpiece
- 2 Display
- 3 "Info" menu button 
- 4 Softkey, right
- 5 Scroll upwards  / Redialling 
- 6 R-button (Flash) 
- 7 Scroll right  / Menu 
- 8 On-hook button, Standby button 
- 9 Digit keys
- 10 #-button / Key lock 
- 11 Microphone
- 12 *-button / Switch ringing tone off / Temporary tone dialling mode 
- 13 Call button (off-hook) 
- 14 Scroll downwards  / Call list 
- 15 Scroll left  / Phone book 
- 16 Handsfree 
- 17 Softkey, left
- 18 Loudspeaker on the rear side



Base station (answering machine)

- 1 Loudspeaker
- 2 Display
- 3 Locate handset (Paging) 
- 4 Volume + 
- 5 Play 
- 6 Play next message 
- 7 Stop 
- 8 Volume - 
- 9 Play previous message 
- 10 Answering machine on/off 
- 11 Delete 
- 12 Charge contacts
- 13 LED: SMS text message
- 14 LED: Call indicator 
- 15 LED: Power 

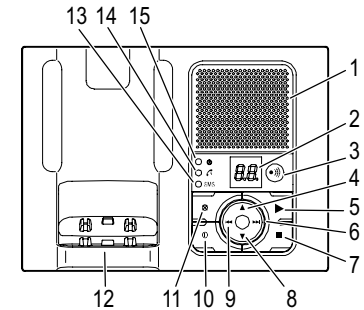















Preliminary Information





4 Preliminary Information

















This chapter provides basic information on using the operating instruction manual and the telephone.

Description of operating sequences in the manual

Display	Description
	Displays the contour of buttons
	Press the button depicted briefly
2 sec. 	Press the button depicted for 2 seconds
Press and hold 	Press and hold down the button depicted
Release 	Release the button depicted
	Enter digits or letters
	Handset rings
	Base station rings
	Remove the handset from the base station
	Place the handset in the base station
	Depicts text in the display
	Depicts icons in the display
	Press the softkey  Page 95

Icons and texts in the handset display

Icon	Description
	On: Indicates the battery charge status. Run-through segments: The battery pack is being charged  Page 94.
	On: The alarm function is activated. Flashing: The alarm is ringing.
hh:mm dd/mm	Display of time and date  Page 108.

	On: A call is currently being made. Flashing: A call has been received  Page 98.
	There are new calls in the call list  Page 109.
	The answering machine is switched on.
	New messages are recorded on the answering machine.
	The ringing tone has been switched off  Page 99.
	Handsfree mode is activated  Page 99.
	The key lock is activated  Page 99.
	On: You have received a new SMS ¹  Page 111. Flashing: SMS text memory is full.
	The microphone has been muted  Page 99.
	On: The connection to the base station is good. Flashing: The connection to the base station is poor. Move nearer to the base station.

¹ **SMS: Short Message Service** = Service for sending text messages.

Standby mode

All descriptions in this operating manual assume that the handset is in Standby mode. The system switches to Standby mode by pressing the  button.

Energy-save mode

When the handset has been in Standby mode for some time, it automatically switches to energy-save mode. The display no longer lights up. Press any button to reactivate Standby mode.

Navigation buttons



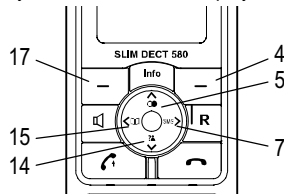





The softkeys (4) and (17) are assigned different functions in the different menus. The function buttons are always referred to in this manual according to the texts directly above them in the display.



Button	In Standby mode	In a menu
4	- Open the main menu	- Open the menu displayed
5	- Open the redialling list	- Scroll through the menu - Change the settings
7	- Open the SMS menu	- Open the menu displayed - Change the settings
14	- Open the call list	- Scroll through the menu - Change the settings
15	- Open the phone book	- Move one level back - Change the settings
17	- Internal calls	- Cancel the programming and saving processes - Move one level back

Navigating in the menu











All the functions can be accessed via the various menus. Refer to the menu structure to find how to access the respective functions  Page 106.

Menu	Open the main menu
 or 	Select the required submenu
OK	Open the submenu
 or 	Select the required function
OK	Open the function
 or 	Select the required setting
	Use the digit keys to enter numbers or letters
OK	Confirm the input
Back	Move one level back
	Cancel the programming/saving processes, activate Standby mode

 Every process is automatically cancelled if there is no input within 30 seconds.

Creating phone book entries - example

The way in which to navigate through the menus and enter data is explained by means of the example **Creating phone book entries**. Proceed as in this example for all the settings.

	Open the phone book
Option	Press the softkey
	If there are no entries in the phone book, the "Option" step is automatically skipped.
 or  , OK	Select the function and confirm it
 	Enter the name and continue
 	Enter the phone number and continue
 or  , OK	Select the group and confirm it

Telephoning

5 Telephoning

Taking a call

or Take the call

Ending a call

or End the call

Switching the handset off and on

You can switch the handset off to save the battery.

2 sec. , **Yes** Switch the handset off

4 sec. Switch the handset on

Making a call

Enter the phone number
(max. 24 digits)

Clear Delete the last digit if incorrect

Dial the phone number

It is also possible to press the Call button /Handsfree button first and wait for the dialling tone. The digits then entered are dialled immediately. It is not possible to correct wrong digits individually using this dialling procedure.

Redialling

The telephone stores the last 20 numbers dialled in a redialling list.
Further information Page 109.

Open the redialling list

or , Select an entry and dial the number

Calling back calls received

The telephone stores the numbers of the last 30 calls received in a call list
 Page 109.

Open the call list

or , Select an entry and dial the number

Dialling numbers from the phone book

There must be phone numbers stored in the phone book Pages 97 and 108

Open the phone book

or , Select an entry and dial the number

Internal calls¹

Making an internal call

There must be two or more handsets (HS1, HS2, ...) registered on your base station in order to make internal calls free of charge.

HS1: **Int** , Dial the internal call number of the handset required
 or , **OK**

HS2: Take the internal call on the other handset

HS1/HS2: End the internal call

Forwarding external calls internally

HS1: **Int** , Dial the internal call number during the conversation with the external caller
 or , **OK**



HS2: Take the internal call on the other handset

HS1: Transfer the call

¹ It is only possible to make internal calls when at least two handsets are connected; "Checking the package contents" on Page 93.

Holding a call / brokering

While a call is in progress, it is possible to dial another handset in order to consult with someone. The external caller is put on hold while you converse with the second, internal person called. You can repeat this procedure as often as required.



HS1: **Int** , Dial the internal call number during the conversation with the external caller
 or  , **OK**

HS2:  Take the internal call on the other handset

HS1: **Brok** Change back and forth between the callers

Making conference calls

An external call can be transferred to another internal handset for a conference call.

HS1: **Int** , Dial the internal call number during the conversation with the external caller
 or  , **OK**

HS2:  Take the internal call on the other handset

HS1: **Conf** Start the conference

HS1: **Single** Only continue the internal call

HS1 / HS2:  End the conference

Setting the receiver volume

The volume can be adjusted to one of 5 settings during a call.

 or  Select the required volume

Talk time display

The duration of a call is displayed in hours, minutes and seconds during the call.

Handsfree

This function is used to listen to the caller via the loudspeaker.

 Activate the handsfree facility

 Deactivate the handsfree facility

Muting the microphone in the handset

The microphone in the handset can be activated and deactivated during a telephone conversation.

 Switch the microphone off (muting function)

 Switch the microphone on

Key lock

The key lock prevents functions assigned to buttons being activated inadvertently.

2 sec.  Activate the key lock function

 Incoming calls can still be taken in the normal way even when the key lock function is activated.
Emergency numbers can still be dialled even if the key lock function is activated.

2 sec.  Deactivate the key lock function

Handset ringing melody

The ringing melody on the handset can be deactivated.

2 sec.  Deactivate the ringing melody

 Only the base station rings in the event of an incoming call, not the handset.

2 sec.  Activate the ringing melody

Searching for the handset (Paging)

If you have mislaid your handset, you can locate it again with the aid of a search tone.

  Start the search tone

 or  End the search tone

6 Phone Book / Call List

Phone Book

You can use the phone book to store up to 200 phone numbers together with the associated names.

Names can have maximally 15 characters and phone numbers maximally 24 digits.

- Always enter the area access code with the phone numbers so that incoming local calls can also be assigned to a phone book entry.
- When the memory capacity is used up, the message “Memory full” appears in the display. To create space, an existing entry must first be deleted.
- The phone book entries are arranged alphabetically. To access the required phone book entry directly, press the first letters of the corresponding name.

Entering names

Letters are also imprinted on the digit keys. Letters, digits and special characters are entered by pressing the relevant key the respective number of times.



To enter the same letter twice, press the button to enter the letter. Wait until the cursor skips one position forwards. Enter the letter again.

The way to:

- create phone book entries,
- edit phone book entries,
- delete phone book entries and
- assign speed dial buttons,

is explained in the “Phone book” menu structure Page 108.

Group selection

You can assign your phone book entries to groups which have specific properties that you can define.

The way to:

- assign your entries to groups,
- edit group names and
- assign melodies,

is explained in the “Phone book” menu structure Page 108.

Call List

A total of 30 phone numbers can be stored in a call list.



The caller number display (**CLIP**¹) is a supplementary service offered by your telephone network provider. The caller number appears in the display if the service is offered by your telephone network provider.

Contact your network provider for further information.

The way to:

- display phone numbers in the call list,
- save phone numbers in the call list in the phone book and
- delete phone numbers from the call list

is explained in the “Call list” menu structure Page 109.

Special phone numbers

Ten important phone numbers can be saved. The entries are then automatically available for all the handsets.

The way to:

- display the entries,
- edit the entries and
- delete the entries

is explained in the “Special phone numbers” menu structure Page 109.

¹ **CLIP**: Calling Line Identification Presentation = Display the caller's phone number.

7 Answering Machine

Operating via the handset



The answering machine is equipped with a vocal operator guidance. Pay attention to the instructions and information.

Opening the Ans. Settings menu

The answering machine settings are defined via the handset Page 106.

Switching the answering machine on/off

The answering machine can be switched on and off via the handset Page 106.

Language

The answering machine's vocal output is English and cannot be changed.

Setting the date and time

The weekday and time of receipt are announced when each message is played back. Setting the date and time Page 108.

Maximum recording time

The answering machine can store up to 59 messages. The maximum recording time is 15 minutes. The length of the messages recorded can be adjusted Page 106. When the memory capacity for new messages is exhausted, no further messages are recorded.

Ringling delay for taking a call

You can select from 2 to 8 rings. In addition, the "Time saver" setting is also available for pre-remote access free of charge. The pre-remote access feature can be used to check whether new messages have been received on your answering machine from a distant telephone.

- If new message have been recorded on your answering machine, your call is taken after 2 rings at the latest.
- If no new messages have been recorded on your answering machine, your call is taken after 4 rings. End the call before the 4th ring. This means that no charges ensue.

For further information on remote access Page 103.

Call screening

You can listen to an incoming call without actually taking the call.

Yes

Activate the call screening function

End

Deactivate the call screening function

Taking a call being recorded

It is possible to take a call even if the answering machine has already begun to take it. Recording of the message is stopped in this case.



Take the call

Selecting the answering mode

The answering machine is provided with two, pre-recorded outgoing messages (OGM). After the "Ans & Rec" outgoing message has been played, the caller can leave a message. "Answer only" is purely an answer only announcement after which no message can be left.

Both pre-recorded outgoing messages can be replaced by ones of your own. When the answering machine's memory is full, "Answer only" is automatically played. Further information Page 106.

Recording/Deleting outgoing messages

Recording outgoing messages

Before recording an outgoing message, select the answering mode (Ans & Rec/Answer only) for which you want to record a message. An outgoing message can be up to 60 seconds long.

Deleting your own outgoing message, reverting to the pre-recorded message

After deleting your own outgoing message, the pre-recorded message is automatically reactivated. Further information Page 106.

Answering Machine

Opening the Play Messages menu

Menu	Open the main menu
<input type="button" value="^"/> or <input type="button" value="v"/>	
Answer machine , OK	Select the submenu and confirm it
<input type="button" value="^"/> or <input type="button" value="v"/>	
Play messages , OK	Select the Play Messages menu and confirm it

Key function assignment, Play Messages menu

The following table provides an overview of the respective functions assigned to the individual buttons in the Play Message menu.

Button	Function
<input type="button" value="🔊"/>	Play messages via the loudspeaker
<input type="button" value="^"/> or <input type="button" value="v"/>	Set the volume
Pause	Pause/Resume playback of messages
<input type="button" value="4"/>	Repeat playback of the message
2 x <input type="button" value="4"/>	Play the previous message
<input type="button" value="5"/> or Delete	Delete the message during playback
<input type="button" value="6"/>	Play the next message
<input type="button" value="📞"/>	Exit the Play Messages menu and return to Standby mode

Playing recorded messages

The recorded messages are played back in the sequence they were recorded. The weekday and time of recording are announced for the respective message prior to being played.

Delete all old messages

All the messages / memos already played are deleted.

Menu	Open the main menu
<input type="button" value="^"/> or <input type="button" value="v"/>	
Answer machine , OK	Select the submenu and confirm it
<input type="button" value="^"/> or <input type="button" value="v"/>	
Delete msg. , OK	Select the function and confirm it
Yes / No	Press the relevant button
 Messages which have been deleted cannot be restored!	

Remote access

You can call your answering machine from another telephone to play messages or execute other functions. A condition is that you use a telephone which implements tone dialling. Remote access must be activated Page 106.

PIN code for remote access

The default setting of the PIN code is "0000". It is recommended to change the PIN code "0000" set at the factory.
Changing the PIN code Page 106.

Starting remote access

	Dial your own phone number
,	While the OGM is playing, press the button and enter the PIN code

If the PIN code entry is incorrect, the OGM is repeated. If the PIN code is entered incorrectly again, the line is automatically disconnected.

You can now execute other functions Table: Function assignment to buttons for remote access.

Remote activation of the answering machine

	Dial your own phone number
	If you forgot to switch your answering machine on, your call is taken after 10 rings.
,	While the OGM is playing, press the button and enter the PIN code
0	Switch the answering machine on/off

You can now execute other functions Table: Function assignment to buttons for remote access.

Function assignment to buttons for remote access

Remote access is automatically cancelled if there is no input within 8 seconds.

The following table provides an overview of the respective functions assigned to the individual buttons.

Button	Functions
1	Play the options menu
2	Start playback of all messages
3	Start playback of new messages
4	Repeat playback of the current message
2 x 4	Play the previous message
5	Delete message during playback
6	Play the next message
7	Select the answering mode: "Ans & Rec" or "Answer only"
8	Play the outgoing message currently set
9	Record an outgoing message "Ans & Rec" or "Answer only"
0	Switch the answering machine on/off
#	End recording of the outgoing message
	Placing the telephone on-hook ends remote access

Answering Machine

Operating via the base station



The answering machine is equipped with a vocal operator guidance. Pay attention to the instructions and information.

Switching the answering machine on/off



Switch the answering machine on/off

Setting the volume

The volume can be set to one of 5 different levels.

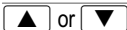

Set the required volume

Playing/Deleting recorded messages

Playing the messages

The recorded messages are played back in the sequence they were recorded. The weekday and time of recording are announced for the respective message prior to being played.



Play the message



Stop playback



Repeat playback of the message



Play the previous message



Play the next message

Deleting a message



Play the message to be deleted



Delete the message while it is being played

Deleting all messages

All the messages / memos already played are deleted.



Start the deleting process



Delete the messages

Answering machine display

The answering machine's display indicates the unit's status.

--

The answering machine is switched off

0-59

The answering machine is switched on, the number of recorded messages is shown



When new messages have been recorded, the message indicator flashes.

rA

Appears when answering machine settings are being made via a handset.

rE

Appears when a message is being recorded.

8 PBX / Supplementary Services

R-button on private branch exchanges

If the telephone is connected to a private branch exchange, functions such as transferring calls and automatic call back can be used via the **R button**. Refer to the operating manual provided with your private branch exchange as to which Flash time must be set in order to use these functions. The sales outlet where you purchased the exchange can provide information as to whether the telephone will work properly with the exchange. The Flash time is set using the menu. Refer to Page 107 for the sequence of menu option selections.

Number for an outside line (exchange code)

In the case of private branch exchanges, it is necessary to dial a specific number in order to obtain the dialling tone for an outside line. This number for an outside line can be stored. When the telephone detects this number preceding a phone number entered, a **dialling pause** is **automatically** inserted after the number.

Setting the number for an outside line  Page 107.

Entering a dialling pause manually

It is possible to insert a **dialling pause manually** after the number for an outside line to be able to continue dialling directly without waiting for the dialling tone.

2 sec. Insert a dialling pause

The actual phone number is dialled a certain time after the number for an outside line.



The dialling pause can also be entered with the phone numbers in the phone book [phone number memory].

R-button and supplementary services

Your telephone supports supplementary services provided by your telephone network provider, such as brokering, call waiting and conference facilities. These supplementary services can be used via the **R-button**. Please contact your telephone network provider regarding which Flash time must be set to use the supplementary services. Contact your telephone network provider with regard to enabling supplementary services. The Flash time is set using the menu. Refer to Page 107 for the sequence of menu option selections.

Caller number display (CLIP¹)



The caller number display function is a supplementary service offered by telephone network providers. Contact your network provider for further information.

If this function is available with your telephone line, the number of the caller appears in the display when the phone rings. If the caller has suppressed transmission of his phone number, the corresponding message appears in the display. The phone number is not displayed and, as a result, is not stored in the call list.

Answering machine in the telephone network

An answering machine in the telephone network is a supplementary service offered by many telephone network providers. If your telephone network provider offers an answering machine in the telephone network for you, you are informed of new messages received by an icon (**VMWI²**). This function can only be used when your telephone network provider actually offers the service. Contact your network provider for further information.

If the supplementary service is activated and a new message has been recorded on the answering machine in the telephone network, you can deactivate the visual indicator via the menu without actually playing the message. Refer to Page 107 for the sequence of menu option selections.

Msg Wait Off ,

Deactivate the message waiting indicator

¹ **CLIP**: Calling Line Identification Presentation = Display the caller's phone number.

² **VMWI**: Visual Message Waiting Indication = Visual indicator that new messages have been recorded.

Menu Structure

9 Menu Structure

Main menu

Access the main menu by pressing the **Menu** softkey. The way to navigate through the menu and make entries and selections are described on Page 97.

SMS¹

Write new SMS		Option	Send	Enter number	Send
				Option	Phonebook
					Redial List
					Call list
			Store		
			Template		
Inbox ²					
Outbox					
Template					
SMS settings	Service centre	Service centre1 - 4			
	Send service	Service centre1/2			
	New SMS alert	On/Off			

Answer machine

Play messages		
Delete msg.		
Answer on/off	On/Off	
Outgoing msg.	Record message	Ans & Rec/Answer only
	Play message	Ans & Rec/Answer only
Ans. Settings	Answer mode	Ans & Rec/Answer only
	Answer Delay	Time saver
		2 Rings - 8 Rings
	Recording Time	30s - 180s
	Call screening	On/Off
Remote Access	Off	
	On	Enter Old PIN →
		→ Enter New PIN →
		→ Repeat PIN



¹ Further information on SMS text messages  Page 111.

² Up to 30 messages can be stored.





Sound

Ringer	External	Melody 1 - 15
	Internal	Melody 1 - 15
	Ring Volume	Off, 1 - 5
	Silence	Off/Beep
Tones	Key Beeps	On/Off
	Confirmation	On/Off
	Battery Low	On/Off
	No coverage	On/Off

Settings

HS Settings	Direct call	System PIN ¹	Off
		On	
	Select Base	Base 1 - 4	
	Display	Contrast 1 - 8	
		Handset Name	
	Language	Deutsch/English/ Italiano/Français	
	Auto Answer	On/Off	
	HS Register	Base 1 - 4	System PIN
	HS De-Register	System PIN	
	Handset Reset	Yes/No	

¹ The default PIN code is "0000".

Base Settings	Ringer	Ringtone	Melody 1 - 5
		Ring Volume	Off, 1 - 5
	HS Priority ²	All Handsets	
		Select Handset	Handset 1 - 5 
			 2/4/6/8
	Dial Mode	Tone/Pulse	
	Flash Time	80ms - 800ms	
	Msg Wait Off		
	System PIN	Enter Old PIN	Enter New PIN 
			 Repeat PIN
	Exchange Code		
	ECO Mode	On/Off	
	System Reset ³	Enter PIN	Yes/No

² This setting is used to define whether all the registered handsets should ring when a call is received or whether one handset should initially have priority and ring.

³ **Attention:** All recorded messages, including new, unplayed messages, are deleted during a system reset!

Menu Structure

⌵	Clock/Alarm	Date/Time	Time format	12 Hour/24 Hour
			Date Format	mm/dd or dd/mm
			Enter Time	
			Enter Date	
	Alarm		Enter Time	
			Alarm On/Off	Off
				Once
				Daily
			Ringtone	Melody 1 - 15

Phone book



to select the required entry, if necessary

Option	New entry	Name	⌵
		Number	⌵
		Select Group	No group
			Family
			Business
			Friends
			Utilities
			VIP
			Others
			General



Edit Entry	Name	⌵
	Number	⌵
	Select Group	No group
		Family
		Business
		Friends
		Utilities
		VIP
		Others
		General
View	Name	⌵
	Number	⌵
	Group Melody	
Copy	Handset 1, 2, ..	
Copy all	Handset 1, 2, ..	
Delete Entry	Yes/No	
Delete all	Yes/No	
Capacity		
Edit call Gp.	Select group	Rename Group
		Ringtone
Speed dial	Number 2 - 9	Select entry



If the speed dial number is already assigned, the entry is displayed.

Special phone numbers

Info / to select the required entry, if necessary

Option	View	Name
		Number
	Delete Entry	
	Edit Entry	Name <input type="button" value="M"/> <input type="button" value="v"/>
		Number <input type="button" value="M"/>
	Delete all	Yes/No

Call list

/ to select the required entry, if necessary

Option	View	
	Delete	
	Delete all Yes/No	
	Call number Option Phonebook	
		Redial List
		Call list
	Store number See New entry	
	Settings	Category All Calls
		Missed Calls
	New Call Alert	On/Off

SMS

SMS Refer to SMS Page 106.

Redialling

/ to select the required entry, if necessary

Option	Delete	Yes/No
	Delete all	Yes/No
	Call number Option	Phonebook
		Redial List
		Call list
	Store number	See New entry

Special Functions

10 Special Functions

Dialling mode

The telephone can be operated in analogue exchanges (PULSE) as well as new, digital exchanges (TONE/DTMF). The dialling mode is controlled via the menu. Refer to Page 107 for the sequence of menu option selections.

Temporary tone dialling

If you only operate the telephone using the PULSE dialling mode, you can still make use of the advantages of the TONE dialling mode (e.g.: remote access of the answering machine in the telephone network). You can temporarily switch to Tone dialling when a connection has already been made.

2 sec. Press when a connection has been established

When the call is ended, the equipment automatically switches back to Pulse dialling.

Alarm

The "Alarm clock" function can be used so that you are alerted by the handset at a specific time. Refer to Page 108 for the sequence of menu option selections.

Direct calls

This function enables you to store a number which is automatically dialled after any button is pressed (except the **Option** softkey). Refer to Page 107 for the sequence of menu option selections.

Speed dial

There must be phone numbers stored as speed dial numbers. Refer to Page 108 for the sequence of menu option selections.

2 sec. to Press the required speed dial button

The phone number assigned is automatically dialled.

Copying phone book entries

Phone book entries can be copied from one handset to another.

Copying single entries

<input type="button" value="☰"/>	Open the phone book
<input type="button" value="^"/> / <input type="button" value="v"/>	Select the required entry
Option	Select the option
<input type="button" value="^"/> / <input type="button" value="v"/> , OK	Select "Copy" and confirm it
<input type="button" value="<"/> / <input type="button" value=">"/> , OK	Select the handset and confirm it
Yes / No	Select accordingly on the receiving handset

Copying all entries

<input type="button" value="☰"/>	Open the phone book
Option	Select the option
<input type="button" value="^"/> / <input type="button" value="v"/> , OK	Select "Copy all" and confirm it
<input type="button" value="<"/> / <input type="button" value=">"/> , OK	Select the handset and confirm it
Yes / No	Select accordingly on the receiving handset

11 SMS - Text Messages

Conditions for using SMS

The telephone connection must be equipped with the **CLIP**¹ feature. Contact your telephone network provider to ensure this feature is enabled on your telephone connection. To use the **SMS**² service, your telephone network provider must enable it.

- A text cannot be sent from every private branch exchange extension.



If you want to send SMS text messages from a private branch exchange extension, it is necessary to store the number for an outside line for your PBX in the handset preceding the Service Centre number.

- Sending SMS messages is not available for Call-by-Call connections at present.
- Charges are made for sending SMS texts.
- If the recipient in the conventional telephone network does not use an SMS service or his telephone is not basically equipped to handle SMS messages, the SMS is automatically converted to a voice message.
- Costs are charged by your telephone network provider.

SMS service centre

SMS messages are distributed via a Service Centre. If you want to send SMS text messages, you must program a service centre number in your handset [Page 106](#). Please contact the provider of your choice for the necessary service centre call numbers and the procedure for enabling the SMS service.



Your telephone has already been prepared to send SMS text messages. Service centre numbers are already programmed in the handset. Activate the required Service Centre in the SMS menu [Page 106](#).

¹ **CLIP**: Calling Line Identification Presentation = Display the caller's phone number.

² **SMS**: Short Message Service = Service for sending text messages.

SMS centre 1	SMS centre 2
Swisscom: 0622100000	Cablecom: 0435375370

Entering text

The digit keys are also labelled with letters for the entry of the respective text. Letters, digits and special characters are entered by pressing the relevant key the respective number of times. Please refer to Menu Structure for a description of navigation for writing texts [Page 106](#).



Switch between upper and lower case

Clear

Delete the last character entered

Press and hold **Clear**

Delete the entire text

SMS text templates

There are 5 pre-programmed text templates available [Page 106](#).

SMS alert signal (alarm)

An acoustic signal is issued when a new SMS text message is received. The signal can be activated or deactivated via the menu. Refer to Page 106 for the sequence of menu option selections.

Extending the Telephone System

12 Extending the Telephone System

The internationally approved **GAP**¹ standard regulates the compatibility of handsets and base stations from different manufacturers. As a result, it is possible to integrate SWITEL devices and devices from other manufacturers together in one telephone system. It is possible, however, that some functions are not available.

Multiple handsets

Up to 5 handsets can be registered on the base station.

Registering handsets

Before starting to register a handset, switch the base station to Registration mode.

Press and hold  until  flashes. Registration mode is activated.

Now register the handset  Page 107. The currently valid PIN code is used for registration purposes  Page 107.

The handset is automatically assigned an internal call number following registration. The internal call number appears in the display.

 To register handsets from other manufacturers, please refer to the operating manual supplied with them.

Deregistering handsets

 Each handset can deregister itself and other handsets registered on the base station. After deregistration, the message Register! appears in the display of the deregistered handset.



Handsets are deregistered via the menu. Refer to Page 107 for the sequence of menu option selections.

Multiple base stations

The range of the handset can be increased by registering it on several base stations. The handset can be registered on up to 4 different base stations simultaneously. Each base station requires its own telephone line socket. Connections can be used with the same call number or with different ones.

Selecting the base station  Page 107.

 Calls in progress cannot be transferred from one base station to another.

 If necessary, you can increase the range of the telephone system by switching ECO mode off  Page 107 (ECO Mode → Off).



¹ **GAP: Generic Access Profile** = Standard for the interoperation of handsets and base stations from different manufacturers.



13 In Case of Problems

Service-Hotline

Should problems arise with the telephone, please refer to the following information first. In the case of technical problems, you can contact our hotline service, Tel. 0900 00 1675 within Switzerland (cost via Swisscom at time of going to print: CHF 2.00/min). In the case of claims under the terms of guarantee, contact your sales outlet. There is a 2 year period of guarantee.

Problems and solutions

Problems	Solutions
No connection to base station possible	<ul style="list-style-type: none"> - Check that the handset has been registered on the base station with the correct PIN code  Page 107.
No telephone calls possible	<ul style="list-style-type: none"> - The telephone is not connected properly or is defective. Only use the telephone connection cable supplied. - Test whether the telephone connection is in order by using another telephone. - The power adaptor plug is not plugged in or there is a complete power failure. - The rechargeable battery pack is empty or defect. - The handset is too far from the base station. - Dialling mode is set incorrectly  Page 107.
Connection is disturbed or cut off	<ul style="list-style-type: none"> - The handset is too far from the base station. - The base station is in an unsuitable location.

The system no longer responds	<ul style="list-style-type: none"> - Reset all the functions to their default settings  Page 107. - Disconnect the power adapter plug briefly from the power socket.
The battery pack is empty in a short time	<ul style="list-style-type: none"> - The battery pack is empty or defect. - Place the handset in the base station properly. Clean the contact surfaces on the handset and base station with a soft, dry cloth. - Place the handset in the base station for 20 hours.
The caller number display (CLIP ¹) does not function	<ul style="list-style-type: none"> - The caller number display function is a supplementary service offered by telephone network providers. Contact your network provider for further information. - The caller has suppressed the transmission of their phone number.
The answering machine does not record any messages	<ul style="list-style-type: none"> - Ensure that the answering machine is connected correctly and switched on. - Check whether the answering machine memory is full. Delete messages from the memory, if necessary  Page 106.
No remote access functions can be executed	<ul style="list-style-type: none"> - Check that the correct security code has been entered for the remote access  Page 106. - The telephone used for remote access must be set to Tone dialling mode.

¹ **CLIP:** Calling Line Identification Presentation = Display the caller's phone number.

Technical Properties

14 Technical Properties

Technical data

Feature	Value
Standard	DECT¹-GAP²
Power supply (base station)	Input: 220/230 V, 50 Hz Output: 6 V, 600 mA
Power supply (charging station)	Input: 220/230 V, 50 Hz Output: 6 V, 300 mA
Range	Outdoors: Approx. 300 m Indoors: Approx. 50 m
Standby	Up to 100 h
Max. talk time	Up to 10 h
Rechargeable battery pack	NiMH 2.4 V 600 mAh
Dialling mode	Tone (DTMF) Pulse
Permissible ambient temperature	10 °C to 30 °C
Permissible relative humidity	20 % to 75 %
Flash function	80, 100, 120, 180, 250, 300, 600 or 800 ms

¹ **DECT**: Digital Enhanced Cordless Telecommunication = Standard for cordless telephones.

² **GAP**: Generic Access Profile = Standard for the interoperation of handsets and base stations from different manufacturers.

Default settings

Handset

The default settings can be restored via the menu. Refer to Page 107 for the sequence of menu option selections.

Ringing volume	5	Key beeps	On
Internal melody	1	Loudspeaker volume	3
External melody	2	Redialling list	Empty
Battery low	On	Receiver volume	3
No coverage	On	Language	Deutsch

Base station

The default settings can be restored via the menu. Refer to Page 107 for the sequence of menu option selections.



Attention: All recorded messages, including new, unplayed messages, are deleted during a System Reset!

System PIN	0000	Flash time	100 ms
Dialling mode	Tone	Ringing tone	1
Exchange code	Empty	Ringing volume	3
Call list	Empty	ECO Mode	On

Answering machine

Answer machine	On	Recording time	60 s
Outgoing msg.	Ans & Rec	Call screening	Enable
Answer delay	Time saver	Remote access	Enable

Declaration of Conformity

This device fulfils the requirements stipulated in the EU directive:

1999/5/EU directive on radio equipment and telecommunications terminal equipment and the mutual recognition of their conformity. Conformity with the above mentioned directive is confirmed by the CE symbol on the device.



To view the complete Declaration of Conformity, please refer to the free download available on our web site www.switel.com.

Maintenance / Guarantee

15 Maintenance / Guarantee

Maintenance

- Clean the housing surfaces with a soft, fluff-free cloth.
- Do not use any cleaning agents or solvents.

Guarantee

SWITEL equipment is produced and tested according to the latest production methods. The implementation of carefully chosen materials and highly developed technologies ensure trouble-free functioning and a long service life. The terms of guarantee do not apply where the cause of equipment malfunction is the fault of the telephone network operator or any interposed private branch extension system. The terms of guarantee do not apply to the batteries or power packs used in the products. The period of guarantee is 24 months from the date of purchase.

All deficiencies related to material or manufacturing errors within the period of guarantee will be redressed free of charge. Rights to claims under the terms of guarantee are annulled following tampering by the purchaser or third parties. Damage caused as the result of improper handling or operation, normal wear and tear, incorrect positioning or storage, improper connection or installation or Acts of God and other external influences are excluded from the terms of guarantee. In the case of complaints, we reserve the right to repair defect parts, replace them or replace the entire device. Replaced parts or devices become our property. Rights to compensation in the case of damage are excluded where there is no evidence of intent or gross negligence by the manufacturer.

If your device shows signs of defect during the period of guarantee, please return it to the sales outlet in which you purchased the SWITEL device together with the purchase receipt. All claims under the terms of guarantee in accordance with this agreement can only be asserted at the sales outlet. No claims under the terms of guarantee can be asserted after a period of two years from the date of purchase and hand-over of the product.

16 Index

A

Alarm, 110
 Alert signal, 111
 Ans Settings menu, 101
 Answering machine, 101
 Answering machine in the telephone network, 105
 Answering mode, 101
 Automatic dialling pause, 105

B

Base station, 93, 95, 112
 Battery charge status, 94
 Brokering, 99

C

Call back, 98
 Call list, 100
 Call screening, 101
 Caller number display, 100, 105
 Charging, 94
 Charging station, 93
 CLIP, 105
 Conference calls, 99
 Copying phone book entries, 110
 Creating, 97, 100

D

Date, 94, 101
 Declaration of Conformity, 115
 Default settings, 114
 Delay, 101
 Deleting, 100, 101, 102, 104
 Deleting messages, 104
 Deregistration, 112
 Dialling, 98
 Dialling mode, 110
 Direct calls, 110
 Display, 96, 104
 Display icons, 96
 Display language, 94

E

ECO mode, 94
 Editing, 100
 Ending a call, 98
 Energy-save mode, 97
 Entering a dialling pause manually, 105
 Entering names, 100
 Entering text, 100, 111
 Extending, 112

F

Forwarding, 98
 Function assignment to buttons, 103
 Functions, 110

G

Group names, 100
 Group selection, 100
 Guarantee, 116

H

Handset, 95, 112
 Handsfree, 99
 Holding a call, 99

I

Icons, 96
 Info, 109
 Inserting the battery pack, 94
 Internal calls, 98

K

Key function assignment, 102
 Key lock, 99

L

Language, 101
 Low-radiation, 94

M

Main menu, 106
 Maintenance, 116
 Making a call, 98
 Maximum recording time , 101
 Melodies, 100
 Menu structure, 106
 Messages, 104
 Muting, 99
 Muting button, 99

N

Navigation buttons, 97
 Notation, 96
 Number for an outside line, 105

O

On-hook, 98
 Operating elements, 95
 Operating via the base station, 104
 Operating via the handset, 101
 Operation, 96
 Outgoing message, 101

P

Package contents, 93
 Paging, 99
 Phone book, 98, 100, 108, 109
 Phone book entries, 97, 100
 PIN code, 103
 Play Message menu, 102
 Playing back, 104
 Playing messages, 102
 Private branch exchanges, 105
 Problems, 113
 Problems and solutions, 113
 Pulse dialling mode, 110

R

R-button, 105
 Receiver volume, 99
 Recording, 101
 Redialling, 98, 109
 Registering, 112
 Remote access, 103
 Remote activation, 103
 Ringing melody, 99

Index

S

Safety information, 92
Save, 100
Saving, 97, 100
Searching for the handset, 99
Service-Hotline, 113
SMS, 111
SMS Service Centre, 111
SMS text templates, 111
Special phone numbers, 100
Speed dial, 100, 110
Standby mode, 97
Starting up, 93
Supplementary services, 105
Switching off, 98, 101, 104
Switching on, 98, 101, 104

T

Taking a call, 94, 98
Taking a call being recorded, 101
Taking a call directly, 94
Talk time, 99
Technical data, 114
Telephoning, 98
Temporary tone dialling, 110
Time, 94, 101
Toll saver, 101
Tone dialling mode, 110
Transferring calls, 98
Troubleshooting, 113

V

VMWI, 105
Volume, 104

SWITEL

Declaration of conformity

WE TELGO AG
OF Route d'Englisberg 11
CH-1763 Granges-Paccot

Declare under our own responsibility that the product

MODEL: DFT817x
DESCRIPTION: Cordless DECT telephone with answering machine

Is in conformity with directives: R&TTE Directive (1999/5/EC)

COMPLIANCE IS ACHIEVED BY CONFORMITY TO THE FOLLOWING:

EN 60950-1, EN 301 489-1/-6, EN 301 406

AUTHORISED BY:

Signed:



Name (printed): Selim Dusi
Position in company: Managing Director
Date of issue: 24.07.2007

Copies of this document will be held on file for a period of 10 years after the last production.



Supplier: TELGO AG, Route d'Englisberg 11
CH-1763 Granges-Paccot
Product: DFT817x

This product is intended for connection to analogue PSTN lines within Switzerland. However, due to differences between the individual PSTNs provided in the different countries, the approval does not, of itself, give an unconditional assurance of successful operation on every PSTN network termination point.