

SWITEL

COMMUNICATION PRODUCTS

Strahlungsarmes schnurloses DECT-/GAP-Telefon mit Anrufbeantworter
Téléphone DECT/GAP sans fil, à faible rayonnement et avec répondeur
Telefono cordless DECT/GAP a basse radiazioni con segreteria telefonica
Low-radiation cordless DECT/GAP telephone with answering machine

DET217x



Bedienungsanleitung
Mode d'emploi
Istruzioni per l'uso
Operating Instructions

D

F

I

GB

SWITEL

Bedienungsanleitung	3
Mode d'emploi	26
Istruzioni per l'uso	49
Operating Instructions	72
Declaration of Conformity	96

1	Sicherheitshinweise	4
2	Telefon in Betrieb nehmen	5
3	Bedienelemente	7
4	Einführende Informationen	8
5	Telefonieren	10
6	Anrufbeantworter	12
7	Nebenstellenanlagen/ Zusatzdienste ..	15
8	Menüstruktur	16
9	Telefonbuch/Anrufliste	18
10	Besondere Funktionen	19
11	Erweitern des Telefonsystems	20
12	Falls es Probleme gibt	21
13	Technische Eigenschaften	23
14	Pflegehinweise / Garantie	24
15	Stichwortverzeichnis	25

Sicherheitshinweise

1 Sicherheitshinweise

Lesen Sie diese Bedienungsanleitung sorgfältig durch.

Bestimmungsgemäße Verwendung

Dieses Telefon ist geeignet zum Telefonieren innerhalb eines Telefonnetzes. Jede andere Verwendung gilt als nicht bestimmungsgemäß. Eigenmächtige Veränderungen oder Umbauten sind nicht zulässig. Öffnen Sie das Gerät in keinem Fall selbst und führen Sie keine eigenen Reparaturversuche durch.

Aufstellungsort

Vermeiden Sie Belastungen durch Rauch, Staub, Erschütterungen, Chemikalien, Feuchtigkeit, Hitze oder direkte Sonneneinstrahlung.

Verwenden Sie das Mobilteil nicht in explosionsgefährdeten Bereichen.

Netzteil



Achtung: Verwenden Sie nur das mitgelieferte Steckernetzteil, da andere Netzteile das Telefon beschädigen können. Sie dürfen den Zugang zum Steckernetzteil nicht durch Möbel oder andere Gegenstände versperren.

Aufladbare Akkus



Achtung: Werfen Sie Akkus nicht ins Feuer. Verwenden Sie nur Akkus des gleichen Typs! Achten Sie auf die richtige Polung! Bei verkehrter Polung der Akkus besteht beim Aufladen Explosionsgefahr.

Stromausfall

Bei Stromausfall kann mit dem Telefon nicht telefoniert werden. Halten Sie für Notfälle ein schnurgebundenes Telefon bereit, welches ohne externe Stromversorgung arbeitet.

D

Medizinische Geräte



Achtung: Benutzen Sie das Telefon nicht in der Nähe von medizinischen Geräten. Eine Beeinflussung kann nicht völlig ausgeschlossen werden.

DECT¹-Telefone können in Hörgeräten einen unangenehmen Brummtönen verursachen.

Entsorgung

Wollen Sie Ihr Gerät entsorgen, bringen Sie es zur Sammelstelle Ihres kommunalen Entsorgungsträgers (z. B. Wertstoffhof). Das nebenstehende Symbol bedeutet, dass Sie das Gerät auf keinen Fall in den Hausmüll werfen dürfen! Nach dem Elektro- und Elektronikgerätegesetz sind Besitzer von Altgeräten gesetzlich gehalten, alte **Elektro- und Elektronikgeräte** einer getrennten Abfallerfassung zuzuführen.



Akkus entsorgen Sie beim batterievertreibenden Handel sowie bei zuständigen Sammelstellen, die entsprechende Behälter bereitstellen.



Verpackungsmaterialien entsorgen Sie entsprechend den lokalen Vorschriften.

¹ **DECT:** Digital Enhanced Cordless Telecommunication = Standard für kabellose Telefone.

2 Telefon in Betrieb nehmen

Sicherheitshinweise



Achtung: Lesen Sie vor der Inbetriebnahme unbedingt die Sicherheitshinweise in Kapitel 1.

Verpackungsinhalt prüfen

Zum Lieferumfang gehören:

Inhalt	DET-Modell			
	2171	2172 ¹	2173 ¹	2174 ¹
Basisstation (Anrufbeantworter) mit Netzteil	1	1	1	1
Ladestation mit Netzteil	-	1	2	3
Mobilteil	1	2	3	4
Telefonanschlusskabel	1	1	1	1
Akkus	2	4	6	8
Bedienungsanleitung	1	1	1	1

¹ Unter www.switel.com erfahren Sie, ob dieses Telefonset bereits erhältlich ist.

Basisstation anschließen



Achtung: Stellen Sie die Basisstation mit einem Mindestabstand von 1 m zu anderen elektronischen Geräten auf, da es sonst zu gegenseitigen Störungen kommen kann.

Schließen Sie die Basisstation wie auf der Skizze abgebildet an. Verwenden Sie aus Sicherheitsgründen nur das mitgelieferte Netzteil sowie das beigefügte Telefonanschlusskabel.

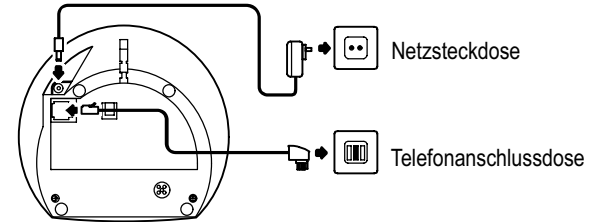

Achtung: Verwenden Sie für die Basisstation mit Anrufbeantworter das Netzteil mit den Ausgangsdaten: 9 V, 500 mA.

Ladestation anschließen²

Schließen Sie die Ladestation wie auf der Skizze abgebildet an. Verwenden Sie aus Sicherheitsgründen nur das mitgelieferte Netzteil.

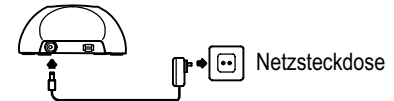

Achtung: Verwenden Sie für die Ladestation das Netzteil mit den Ausgangsdaten: 6 V, 150 mA.

D

² Gilt nur für Telefonsets mit mindestens zwei Mobilteilen
☞ "Verpackungsinhalt prüfen" auf Seite 5.

Telefon in Betrieb nehmen

Akkus einlegen

Legen Sie die Akkus in das geöffnete Akkufach ein. Verwenden Sie nur Akkus des Typs AAA NiMH 1,2 V. Achten Sie auf die richtige Polung! Schließen Sie das Akkufach.

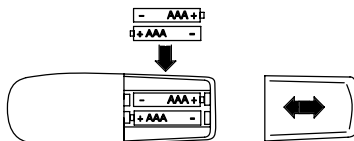

Akkus aufladen

Stellen Sie das Mobilteil bei der ersten Inbetriebnahme für **mindestens** 14 Stunden in die Basisstation / Ladestation.

Haben Sie das Mobilteil richtig in die Basisstation / Ladestation gestellt, ertönt ein Hinweissignal. Das Mobilteil erwärmt sich beim Laden. Dies ist normal und ungefährlich. Laden Sie das Mobilteil nicht mit fremden Aufladegeräten. Der aktuelle **Akkuladezustand** wird im Display angezeigt:



Voll



Halb



Schwach



Leer

Automatische Anrufannahme

Haben Sie die Funktion aktiviert, wird ein Anruf automatisch beim Herausnehmen des Mobilteils aus der Basisstation angenommen. Die automatische Anrufannahme wird über das Menü aktiviert oder deaktiviert. Auf Seite 16 finden Sie die Position im Menü.

Nebenstellenanlagen

Auf Seite 15 erhalten Sie weitere Informationen, falls Sie Ihr Telefon an eine Nebenstellenanlage anschließen möchten.

Strahlungsreduzierung (ECO-Mode)

Werkseinstellung = ECO-MODE → AUS

Sie können das Telefon so einstellen, dass die Strahlung reduziert wird
☞ Seite 17.



= ECO MODE → EIN.











Sowohl im Gesprächs- als auch im Bereitschaftsmodus wird die Strahlung bei eingeschaltetem ECO-Mode im Vergleich zu Standard-DECT-Schnurlostelefonen erheblich verringert.

Bei Bedarf können Sie die Reichweite des Telefonsystems erhöhen, indem Sie den ECO-MODE ausschalten ☞ Seite 17 (ECO MODE → AUS).

3 Bedienelemente







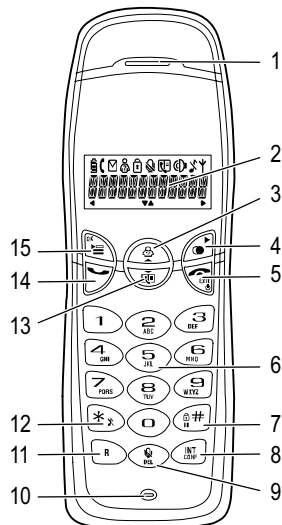

Die Tasten Ihres Telefons werden in dieser Bedienungsanleitung nachfolgend mit vereinheitlichten umrandeten Symbolen dargestellt. Leichte Abweichungen der Tastensymbole Ihres Telefons gegenüber den hier verwendeten Tastensymbolen sind daher möglich.

Mobilteil

- 1 Lautsprecher
- 2 Display
- 3 Aufwärts / Anrufliste 
- 4 Wahlwiederholung / weiter 
- 5 Auflengetaste / Ein-/Ausschalter 
- 6 Zifferntastenblock
- 7 #-Taste / Tastensperre 
- 8 Interngespräch / Konferenz 
- 9 Mikrofon stummschalten / Löschen 
- 10 Mikrofon
- 11 R-Taste (Flash) 
- 12 *-Taste / Tonruf ausschalten / Temporäre Tonwahl 
- 13 Abwärts / Telefonbuch 
- 14 Gesprächstaste 
- 15 Menütaste / Bestätigung 



Basisstation (Anrufbeantworter)

- 1 Anrufbeantworter ein / aus 
- 2 Mobilteil suchen (Paging) 
- 3 Lautstärkeregelung 
- 4 Wiedergabe / Stopp 
- 5 Zurückspringen / Hinweissignal 
- 6 Vorwärtsspringen / Mithören ein / aus 
- 7 Mikrofon
- 8 Löschen 
- 9 Ansage anhören / aufnehmen 
- 10 Display
- 11 Memo aufnehmen 
- 12 Lautsprecher

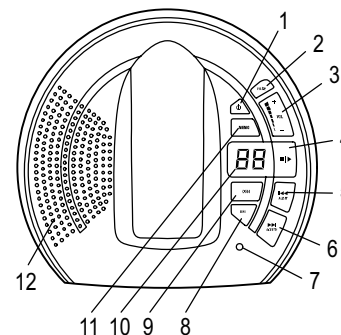

Ladestation¹

- 1 Ladekontakte

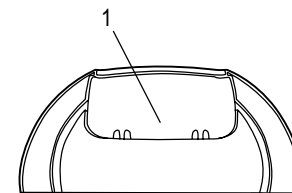













¹ Gilt nur für Telefonsets mit mindestens zwei Mobilteilen
 "Verpackungsinhalt prüfen" auf Seite 5.

Einführende Informationen







4 Einführende Informationen











In diesem Kapitel finden Sie grundlegende Informationen zur Handhabung der Bedienungsanleitung und des Telefons.

Darstellungweise in der Bedienungsanleitung

Darstellung	Beschreibung
	Darstellung von Tasten
	Abgebildete Taste kurz drücken
2 Sek. 	Abgebildete Taste 2 Sekunden drücken
halten 	Abgebildete Taste halten
loslassen 	Abgebildete Taste loslassen
	Ziffern oder Buchstaben eingeben
	Mobilteil klingelt
	Basisstation klingelt
	Mobilteil aus der Basisstation nehmen
	Mobilteil in die Basisstation stellen
	Darstellung von Display-Texten
	Darstellung von Display-Symbolen

Symbole und Texte im Display des Mobilteils

Symbol	Beschreibung
	Konstant: Anzeige der Batteriekapazität. Blinkend: Laden Sie die Akkus. Durchlaufende Segmente: Die Akkus werden geladen  Seite 6.
	Konstant: Sie führen ein Gespräch. Blinkend: Es erreicht Sie ein Anruf  Seite 10.
	Konstant: Sie befinden sich in der Anrufliste. Es sind neue Anrufe in der Anrufliste  Seite 18.

 oder 	Links oder rechts befinden sich weitere Ziffern der angezeigten Rufnummer.
	Der Tonruf ist ausgeschaltet  Seite 11.
	Die Tastensperre ist aktiviert  Seite 11.
	Anrufbeantworter im Telefonnetz. VMWI ¹ - Zusatzdienst Ihres Netzbetreibers  Seite 15.
	Das Mikrofon ist stummgeschaltet  Seite 11.
	Konstant: Die Verbindung zur Basisstation ist gut. Blinkend: Die Verbindung zur Basisstation bricht ab. Nähern Sie sich der Basisstation.

¹ **VMWI**: Visual Message Waiting Indication = Optische Anzeige neuer Nachrichten.

Bereitschaftsmodus

Alle Beschreibungen in dieser Bedienungsanleitung gehen davon aus, dass sich das Mobilteil im Bereitschaftsmodus befindet. Den Bereitschaftsmodus erreichen Sie, indem Sie die Taste  drücken.

Energiesparmodus

Nach einiger Zeit im Bereitschaftsmodus wechselt das Mobilteil in einen Energiesparmodus. Das Display ist nun nicht mehr beleuchtet. Drücken Sie eine beliebige Taste, um den Bereitschaftsmodus zu aktivieren.



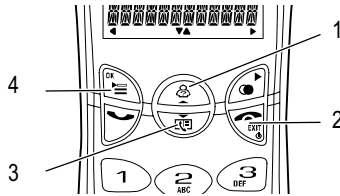









Navigationstasten



Taste	Im Bereitschaftsmodus	Im Menü
1	- Anrufliste öffnen	- In den Menüs blättern
2	- Mobilteil ein-, ausschalten	- Eine Ebene zurück - Programmier- und Speichervorgänge abbrechen
3	- Telefonbuch öffnen	- In den Menüs blättern
4	- Hauptmenü öffnen	- Angezeigtes Menü öffnen/ Menüpunkt öffnen

Navigation im Menü

Alle Funktionen sind über unterschiedliche Menüs zu erreichen. Den Weg zur gewünschten Funktion entnehmen Sie der Menüstruktur  Seite 16.











	Hauptmenü öffnen
 oder 	Gewünschtes Untermenü auswählen
	Untermenü öffnen
 oder 	Gewünschte Funktion auswählen
	Funktion öffnen
 oder 	Gewünschte Einstellung auswählen
	Über Tastenfeld Nummern oder Buchstaben eingeben
	Eingaben bestätigen
	Eine Ebene zurück



Jeder Vorgang wird automatisch abgebrochen, wenn innerhalb von 30 Sekunden keine Eingabe erfolgt.

Telefonbucheinträge erstellen - Beispiel

Wie Sie in den Menüs navigieren und Eingaben vornehmen, ist hier anhand des Beispiels **Telefonbucheinträge erstellen** erklärt. Verfahren Sie bei allen Einstellungen wie in diesem Beispiel.

	Menü öffnen
 oder 	
TELEFONBUCH, 	Funktion auswählen und bestätigen
 oder 	
HINZUFUEGEN, 	Funktion auswählen und bestätigen
 	Namen eingeben (max. 12 Stellen) und bestätigen
 	Rufnummer eingeben (max. 20 Ziffern) und bestätigen

Telefonieren

5 Telefonieren

Anruf annehmen

,  oder  Anruf annehmen

Gespräch beenden

 oder  Gespräch beenden

Anrufen

 Rufnummer eingeben (max. 20 Ziffern)

 Bei Falscheingabe letzte Ziffer löschen

 Rufnummer wählen

 Sie können auch zuerst die Gesprächstaste drücken und erhalten damit das Freizeichen. Die eingegebenen Ziffern Ihrer gewünschten Rufnummer werden sofort gewählt. Eine Korrektur einzelner Ziffern der Rufnummer ist bei dieser Form des Gesprächsaufbaus nicht möglich.

Wahlwiederholung



Ihr Telefon speichert die zuletzt gewählte Rufnummer.

  Wahlwiederholung einleiten und Verbindung herstellen

Eingegangene Anrufe zurückrufen

Ihr Telefon speichert 20 Anrufe in einer Anrufliste.



 Anrufliste öffnen

 oder ,  Eintrag auswählen und Verbindung herstellen

Rufnummern aus dem Telefonbuch wählen

Sie müssen Rufnummern im Telefonbuch gespeichert haben  Seite 9 und Seite 18.

 Telefonbuch öffnen

 oder ,  Eintrag auswählen und Verbindung herstellen

Intern telefonieren¹

Interne Gespräche führen



Sie müssen zwei oder mehr Mobilteile (MT1, MT2, ...) an Ihrer Basisstation angemeldet haben, um interne kostenlose Gespräche führen zu können.

MT1: , z. B.  Interne Rufnummer des gewünschten Mobilteils wählen

MT2:  Internes Gespräch am anderen Mobilteil annehmen



MT1 / MT2:  Internes Gespräch beenden

Externe Gespräche intern weiterleiten

MT1: , z. B.  Während des externen Gesprächs interne Rufnummer wählen

MT2:  Internes Gespräch am anderen Mobilteil annehmen



MT1:  Gespräch weiterleiten

 Sollte sich das gerufene Mobilteil nicht melden, können Sie sich das externe Gespräch zurückholen, indem Sie die Taste  drücken.

¹ Das interne Telefonieren ist nur mit mindestens zwei Mobilteilen möglich  "Verpackungsinhalt prüfen" auf Seite 5.

Rücksprache / Makeln

Während eines externen Gesprächs können Sie ein anderes Mobilteil auswählen, um Rücksprache zu halten. Der externe Gesprächspartner wird gehalten, während Sie mit dem internen Gesprächspartner sprechen. Diesen Vorgang können Sie beliebig oft wiederholen.



MT1: , z. B.  Während des externen Gesprächs interne Rufnummer wählen

MT2:  Internes Gespräch am anderen Mobilteil annehmen

MT1:  Gesprächspartner wechseln

Konferenzgespräche führen

Ein externes Gespräch kann mit einem weiteren internen Gesprächspartner zum Konferenzgespräch geschaltet werden.

MT1: , z. B.  Während des externen Gesprächs interne Rufnummer wählen

MT2:  Internes Gespräch am anderen Mobilteil annehmen

MT1: 2 Sek.  Konferenz starten

MT1 / MT2:  Konferenz beenden

Einstellen der Hörerlautstärke

Sie können während eines Gesprächs die Lautstärke in 3 Stufen anpassen.

 oder  Gewünschte Lautstärke auswählen

Anzeige der Gesprächsdauer

Während eines Gesprächs wird die Gesprächsdauer in Minuten und Sekunden angezeigt.

Mikrofon im Mobilteil stummschalten

Sie können während eines Telefongesprächs das Mikrofon des Mobilteils aus- und einschalten.

 Mikrofon ausschalten (stummschalten)

 Mikrofon einschalten

Tastensperre

Die Tastensperre verhindert, dass versehentlich Tasten gedrückt werden.

2 Sek.  Tastensperre einschalten

 Bei eingeschalteter Tastensperre können eingehende Anrufe wie gewohnt angenommen werden.

2 Sek.  Tastensperre ausschalten

Tonrufmelodie des Mobilteils

Sie können die Tonrufmelodie am Mobilteil ausschalten.

2 Sek.  Tonrufmelodie ausschalten

 Anrufe werden nun über die Basisstation und nicht mehr über das Mobilteil signalisiert.

2 Sek.  Tonrufmelodie einschalten

Mobilteil suchen (Paging)

Wenn Sie Ihr Mobilteil verlegt haben, können Sie es über einen Suchton leicht wiederfinden.

   Suchton starten

  oder  Suchton beenden

Mobilteil aus- und einschalten

Um die Akkus zu schonen, können Sie das Mobilteil ausschalten.

2 Sek.  Mobilteil ausschalten

2 Sek.  Mobilteil einschalten

Anrufbeantworter

6 Anrufbeantworter

Anrufbeantworter ein-/ausschalten



Anrufbeantworter ein-/ausschalten

Maximale Aufnahmezeit

Der Anrufbeantworter speichert bis zu 60 Nachrichten. Die maximale Aufnahmezeit beträgt 7 Minuten. Die maximale Aufnahmezeit jeder Nachricht beträgt 2 Minuten. Ist die Speicherkapazität für neue Nachrichten erschöpft, wird kein Anruf mehr aufgezeichnet.

Lautstärke einstellen

Sie können die Lautstärke in 5 Stufen einstellen.



Lautstärke einstellen

Anzahl Tonrufe einstellen (Verzögerung)

Sie können zwischen 2 bis 7 Tonrufen und der Einstellung **Gebührensparer** für die gebührenfreie Vor-Fernabfrage wählen. Mit der gebührenfreien Vor-Fernabfrage können Sie feststellen, ob sich neue Nachrichten auf Ihrem Anrufbeantworter befinden.

- Befinden sich neue Nachrichten auf Ihrem Anrufbeantworter, wird Ihr Anruf bereits nach 2 Tonrufen angenommen.
- Wurden keine Nachrichten aufgezeichnet, wird Ihr Anruf erst nach 4 Tonrufen angenommen. Legen Sie vor dem 4. Tonruf auf. So fallen keine Gebühren an.



Diese Einstellung führen Sie am Mobilteil durch Seite 16!

Weitere Informationen über die Fernabfrage Seite 13.

Hinweissignal bei aufgezeichneten Nachrichten

Wurde eine neue Nachricht oder ein Memo aufgezeichnet, ertönt jede Minute ein Signalton.



Hinweissignal ein-/ausschalten

Mithören eingehender Nachrichten

Sie können eingehende Anrufe mithören, ohne den Anruf anzunehmen.



Mithören ein-/ausschalten

Anruf übernehmen

Wenn der Anrufbeantworter bereits einen Anruf entgegengenommen hat, können Sie dieses Gespräch übernehmen. Die Aufzeichnung der Nachricht wird in diesem Fall abgebrochen.



Anruf übernehmen

Ansage aufzeichnen / kontrollieren oder löschen

Ihr Anrufbeantworter stellt Ihnen zwei voreingestellte Ansagetexte zur Verfügung. Nach dem Ansagetext 1 kann eine Nachricht hinterlassen werden. Bei Ansagetext 2 handelt es sich um eine Nur-Ansage, nach der keine Nachricht hinterlassen werden kann. Sie können Ansagetext 1 durch einen eigenen Ansagetext ersetzen. Ansagetext 2 ist nicht veränderbar. Ist der Speicher des Anrufbeantworters voll, wird automatisch Ansagetext 2 wiedergegeben.

Ansagen aufzeichnen

Die Länge der eigenen Ansage darf bis zu 40 Sekunden betragen.

2 Sek.

Aufzeichnung starten



Ansage sprechen und bestätigen

Kontrollieren der aktuell eingestellten Ansage

Ansage anhören

Eigene Ansage löschen und zur Standardansage zurückkehren

Wenn Sie Ihre eigene Ansage löschen, wird die voreingestellte Standardansage wieder aktiviert.

Ansage anhören

Ansage löschen

Memo aufzeichnen / abhören oder löschen

Ein Memo ist eine Mitteilung, die wie eine eingegangene Nachricht abgehört werden kann. Sie können maximal ein Memo aufzeichnen.

Memo aufzeichnen

Die Länge des Memos darf bis zu 2 Minuten betragen.

2 Sek. MEMO	Aufzeichnung starten
 ▶▶	Memo sprechen und bestätigen

Memo abhören

MEMO	Memo abhören
-------------	--------------

Memo löschen

MEMO	Memo abhören
DEL	Memo löschen

Aufgezeichnete Nachrichten abhören / löschen

Nachrichten abhören

Wenn ein Memo aufgezeichnet wurde, wird zuerst das Memo vor den eingegangenen Nachrichten abgespielt. Die aufgezeichneten Nachrichten werden in der Reihenfolge wiedergegeben, in der sie eingegangen sind.

2 Sek. ▶▶	Neue Nachrichten abhören
▶▶	Alle Nachrichten abhören
▶▶	Wiedergabe stoppen
 ALERT	Nachricht wiederholen
 SCREEN	Nächste Nachricht

Eine Nachricht löschen

▶▶	Zu löschende Nachricht abhören
DEL	Nachricht löschen

Alle Nachrichten / Memos löschen

Es werden alle Nachrichten / Memos gelöscht. Neue Nachrichten / Memos bleiben erhalten.

2 Sek. DEL	Löschvorgang starten
DEL	Nachrichten / Memos löschen

















Die Fernabfrage

Sie können Ihren Anrufbeantworter anrufen, um Nachrichten abzuhören und weitere Funktionen durchzuführen. Voraussetzung dafür ist ein Telefon mit Tonwahlfunktion.





Der Sicherheitscode für die Fernabfrage

Um die Fernabfrage durchzuführen, müssen Sie einen Sicherheitscode eingeben. Dieser ist werkseitig auf "000" eingestellt.

 Diese Einstellung führen Sie am Mobilteil durch!

	Menü öffnen
 oder 	
EINSTELL , 	Untermenü auswählen und bestätigen
 oder 	
ANRUFBEANTW , 	Untermenü auswählen und bestätigen
 oder 	
FERNABFRA PIN , 	Funktion auswählen und bestätigen
 	Alte PIN eingeben
 	Neue PIN eingeben
 	Neue PIN wiederholen

Fernabfrage starten

 	Eigene Rufnummer wählen
*x ,  	Während der Ansage betätigen und Sicherheitscode eingeben

 Bei falscher Eingabe hören Sie erneut die Ansage des Anrufbeantworters. Wurde der Sicherheitscode dreimal falsch eingegeben, wird die Leitung automatisch getrennt.



Jetzt haben Sie die Möglichkeit, weitere Funktionen durchzuführen
 Tabelle Tastenfunktionen.

Anrufbeantworter

Ferneyschalten des Anrufbeantworters

 Eigene Rufnummer wählen

 Haben Sie vergessen, Ihren Anrufbeantworter einzuschalten, wird Ihr Anruf erst nach 10 Tonrufen angenommen.

 ,  Während der Ansage betätigen und PIN-Code eingeben

 Anrufbeantworter ein-/ausschalten













Jetzt haben Sie die Möglichkeit, weitere Funktionen durchzuführen

 Tabelle Tastenfunktionen.

Tastenfunktionen der Fernabfrage

 Die Fernabfrage wird automatisch abgebrochen, wenn innerhalb von 8 Sekunden keine Eingabe erfolgt.

Die Tastenfunktionen sind abhängig davon, in welchem Modus Sie sich befinden. Die folgende Tabelle verschafft Ihnen eine Übersicht über die jeweiligen Funktionen der einzelnen Tasten.

Taste	Funktionen	Funktionen während des Abhörens einer Nachricht
		Vorherige Nachricht abspielen
	Nachrichten abspielen	Laufende Nachricht erneut abspielen
		Nächste Nachricht abspielen
	Memo abspielen	
	Aktion beenden	Laufende Nachricht stoppen
	Ansage abspielen	
	Memo aufzeichnen	
	Anrufbeantworter ein-/ausschalten	
	Ansage aufzeichnen	
		Laufende Nachricht löschen
 , 	Alle Nachrichten löschen	
	Das Auflegen beendet die Fernabfrage	

7 Nebenstellenanlagen / Zusatzdienste

R-Taste an Nebenstellenanlagen

Ist Ihr Telefon an einer Nebenstellenanlage angeschlossen, können Sie über die **R-Taste** Funktionen, wie z. B. Anrufe weiterleiten und automatischen Rückruf, nutzen. Lesen Sie bitte in der Bedienungsanleitung Ihrer Nebenstellenanlage, welche Flash-Zeit Sie zur Nutzung dieser Funktionen einstellen müssen. Ob Ihr Telefon an Ihrer Nebenstellenanlage einwandfrei funktioniert, erfahren Sie bei dem Händler, bei dem die Anlage gekauft wurde. Die Flash-Zeit stellen Sie über das Menü ein. Auf Seite 16 finden Sie die Position im Menü.

Wahlpause

Bei Nebenstellenanlagen ist es erforderlich, eine Amtskennzahl vorzuwählen, um ein Freizeichen zu bekommen. Bei wenigen älteren Nebenstellenanlagen dauert es einige Zeit, bis das Freizeichen zu hören ist. Für diese Nebenstellenanlagen kann nach der Amtskennzahl eine Wahlpause eingefügt werden, um direkt weiterwählen zu können, ohne das Freizeichen abzuwarten.

2 Sek. Wahlpause einfügen

Nach der Amtskennzahl erfolgt die Wahl der eigentlichen Rufnummer nach einer bestimmten Zeit.



Die Wahlpause kann auch bei der Eingabe von Rufnummern im Telefonbuch gespeichert werden.

R-Taste und Zusatzdienste

Ihr Telefon unterstützt Zusatzdienste Ihres Netzbetreibers, wie z. B. Makeln, Anklopfen und Konferenz. Über die **R-Taste** können Sie diese Zusatzdienste nutzen. Bitte fragen Sie Ihren Netzbetreiber, welche Flash-Zeit Sie zur Nutzung von Zusatzdiensten einstellen müssen. Zur Freischaltung von Zusatzdiensten wenden Sie sich bitte an Ihren Netzbetreiber. Die Flash-Zeit stellen Sie über das Menü ein. Auf Seite 16 finden Sie die Position im Menü.

Rufnummernanzeige (CLIP¹)



Die Rufnummernanzeige ist ein Zusatzdienst Ihres Netzbetreibers. Fragen Sie Ihren Netzbetreiber nach weiteren Informationen.

Wenn diese Funktion an Ihrer Telefonleitung zur Verfügung steht, wird Ihnen bereits die Rufnummer des Anrufers angezeigt, wenn das Telefon klingelt. Hat der Anrufer das Übertragen seiner Rufnummer unterdrückt, wird eine entsprechende Meldung angezeigt. Die Rufnummer kann nicht angezeigt und somit auch nicht in der Anrufliste gespeichert werden.

Anrufbeantworter im Telefonnetz

Der Anrufbeantworter im Telefonnetz ist ein Zusatzdienst vieler Netzbetreiber. Wenn Ihr Netzbetreiber einen Anrufbeantworter im Telefonnetz für Sie bereitstellt, werden Sie mit einem Symbol über neue Nachrichten informiert (**VMWI**²). Über diese Funktion können Sie nur dann verfügen, wenn Ihr Netzbetreiber diesen Zusatzdienst anbietet. Bitte fragen Sie Ihren Netzbetreiber nach weiteren Informationen.





¹ **CLIP**: Calling Line Identification Presentation = Anzeige der Rufnummer eines Anrufers.





² **VMWI**: Visual Message Waiting Indication = Optische Anzeige neuer Nachrichten.

Menüstruktur

8 Menüstruktur

Hauptmenü

In das Hauptmenü gelangen Sie, wenn Sie die Taste  drücken. Danach wählen Sie mit den Tasten  /  einen Eintrag aus und bestätigen Sie Ihre Auswahl mit der Taste .

TELEFONBUCH	HINZUFUEGEN	NAME?	NUMMER?	
	BEARBEITEN	 / 		
	LOESCHEN	 / 	OK?	
	ALLE LOESCH	OK?		
DISPLAY	MOBILT-NAME			
	BELEUCHTUNG	EIN	AUS	
	SPRACHE	DEUTSCH, FRANCAIS, ENGLISH, ITALIANO		
TOENE	MOBIL	MELODIE	MELODIE 1-10	
		LAUTST	AUS, 1-5	
	BASIS	MELODIE	MELODIE 1-10	
		LAUTST	AUS, 1-5	
	MT-TASTENTON	EIN	AUS	
	MT-TOENE	EIN	AUS	
EINSTELL	ANRUFBEANTW	ANZ TONRUF	1-7, GEB-SPARER	
		FERNABFRA PIN	NEUE PIN	WIEDERHOLEN
	AUTO ANNAHME	EIN	AUS	
	WAHLMODUS	DTMF	IMPULS	
	FLASHZEIT	FLASHZEIT 1-2	(100 ms / 300 ms)	



SYSTEM	ANMELDEN	PIN (0000)	1 2 3 4	SUCHE BASIS
	BASISWAHL	AUTO	BASIS 1-4	
	MT ABMELDEN	MOBILTEIL 1-4	PIN	
	PIN ANDERN	PIN	NEUE PIN	WIEDERHOLEN
	ECO MODE	EIN	AUS	
	RESET	PIN		

Telefonbuch

9 Telefonbuch / Anrufliste



Telefonbuch

Im Telefonbuch können Sie 20 Rufnummern mit den dazugehörigen Namen speichern.

- Geben Sie bei allen Rufnummern immer die Vorwahl mit ein, damit auch eingehende Ortsgespräche einem Telefonbucheintrag zugeordnet werden können.
- Ist die Speicherkapazität erschöpft, zeigt das Display beim nächsten Speichern eine Meldung. Um wieder Platz zu schaffen, müssen Sie zuerst einen anderen Eintrag löschen.
- Die Telefonbucheinträge sind alphabetisch geordnet. Um direkt zum gewünschten Telefonbucheintrag zu gelangen, drücken Sie den entsprechenden Anfangsbuchstaben.

Namen eingeben

Die Ziffern-Tasten sind mit Buchstaben beschriftet. Durch mehrmaliges Drücken der entsprechenden Taste können Buchstaben und Ziffern eingegeben werden.

	Leerzeichen eingeben
	Löschen

 Ist ein Name bereits im Telefonbuch vorhanden, wird die Meldung KOPIEREN angezeigt. Ändern Sie den Namen.

 Um den gleichen Buchstaben zweimal einzugeben, drücken Sie den entsprechenden Buchstaben. Warten Sie, bis der Cursor eine Stelle weitergesprungen ist. Geben Sie den Buchstaben erneut ein.

Anrufliste

Insgesamt werden 20 Rufnummern in einer Anrufliste gespeichert.



Die Rufnummernanzeige (**CLIP**¹) ist ein Zusatzdienst Ihres Netzbetreibers. Ihr Telefon zeigt die Rufnummern im Display, wenn Ihr Netzbetreiber diesen Service anbietet. Bitte fragen Sie Ihren Netzbetreiber nach weiteren Informationen.

¹ **CLIP**: Calling Line Identification Presentation = Anzeige der Rufnummer eines Anrufers.

Rufnummern aus der Anrufliste anzeigen

 ,  oder  Anrufliste öffnen und Eintrag auswählen





Rufnummern aus der Anrufliste im Telefonbuch speichern

Eine Rufnummer kann direkt aus der Anrufliste im Telefonbuch gespeichert werden.

 ,  oder  ,  Anrufliste öffnen und Eintrag auswählen

 oder  **SPEICHERN** ,  Speichervorgang starten

 ,  ,  ,  Namen eingeben, bestätigen

 ,  ,  ,  ggf. Nummer bearbeiten, bestätigen





Sobald die Rufnummer im Telefonbuch mit einem Namen gespeichert wurde, erscheint in der Anrufliste der eingegebene Name.

Rufnummern aus der Anrufliste löschen

Einzelne Rufnummern löschen

 ,  oder  ,  Anrufliste öffnen und Eintrag auswählen



 oder  **LOESCHEN** ,  Löschvorgang aktivieren

 oder  Löschvorgang bestätigen oder abbrechen

Alle Rufnummern löschen

 ,  Anrufliste öffnen

 oder  **ALLE LOESCH** ,  Löschvorgang aktivieren

 oder  Löschvorgang bestätigen oder abbrechen

10 Besondere Funktionen

Wahlverfahren

Sie können Ihr Telefon sowohl an den analogen Vermittlungsstellen (Impuls-Wahlverfahren) als auch an den neuen digitalen Vermittlungsstellen (Ton-Wahlverfahren) betreiben. Das Wahlverfahren wird über das Menü eingestellt. Auf Seite 16 finden Sie die Position im Menü.

Temporäre Tonwahl

Können Sie Ihr Telefon nur mit dem Impuls-Wahlverfahren betreiben, brauchen Sie nicht auf die Vorteile des Ton-Wahlverfahrens (z. B.: Abfrage eines Anrufbeantworters im Telefonnetz) zu verzichten. Während einer bestehenden Verbindung können Sie vorübergehend zum Ton-Wahlverfahren wechseln.

1 Sek. Während des Gesprächs drücken

Nach Gesprächsende wird wieder automatisch auf das Impuls-Wahlverfahren zurückgeschaltet.

Erweitern des Telefonsystems

11 Erweitern des Telefonsystems

Über den international genormten **GAP**¹-Standard ist die Kompatibilität von Mobilteilen und Basisstationen unterschiedlicher Hersteller geregelt. So ist es möglich, SWITEL-Geräte und Geräte anderer Hersteller zusammen in ein Telefonsystem zu integrieren. Es ist jedoch möglich, dass einige Funktionen nicht zur Verfügung stehen.

Mehrere Mobilteile

Sie können insgesamt 4 Mobilteile an Ihre Basisstation anmelden.

Anmelden von Mobilteilen

Bevor Sie ein Mobilteil anmelden, müssen Sie die Basisstation in den Registriermodus setzen.

4 Sek.   Registriermodus starten

Melden Sie nun das Mobilteil an  Seite 17. Benutzen Sie zur Anmeldung den aktuell eingestellten PIN-Code  Seite 17.

Nach dem Anmelden wird dem Mobilteil eine interne Rufnummer gegeben. Diese interne Rufnummer wird im Display angezeigt.

 Um Mobilteile anderer Hersteller anzumelden, lesen Sie bitte deren Bedienungsanleitungen.

Abmelden von Mobilteilen

 Sie können ein Mobilteil von einer Basisstation nur durch ein weiteres an dieser Basisstation angemeldetes Mobilteil abmelden.

Mobilteile werden über das Menü abgemeldet. Auf Seite 17 finden Sie die Position im Menü.

Mehrere Basisstationen

Sie können die Reichweite Ihres Mobilteils vergrößern, wenn Sie es an mehrere Basisstationen anmelden. Es kann gleichzeitig an 4 verschiedenen Basisstationen angemeldet sein. Jede Basisstation benötigt eine eigene Telefonsteckdose. Es können Anschlüsse mit derselben und auch mit unterschiedlichen Rufnummern sein.

 Laufende Gespräche können nicht von einer zur anderen Basisstation übertragen werden.

Erhöhung der Reichweite

Platzieren Sie die Basisstationen so, dass sich die Reichweite der einzelnen Basisstationen überschneidet. Testen Sie die Reichweite Ihrer Mobilteile, da Hindernisse in Gebäuden die Reichweite einschränken. Melden Sie das Mobilteil an alle Basisstationen an. Schalten Sie die Funktion **automatische Wahl** von Basisstationen ein  Seite 17. Das Mobilteil sucht sich automatisch die nächstgelegene Basisstation mit der besten Verbindung.

 Bei Bedarf können Sie die Reichweite des Telefonsystems erhöhen, indem Sie den ECO-Mode ausschalten  Seite 17 (ECO MODE → AUS).

Mobilität durch verschiedene Standorte

Melden Sie das Mobilteil an verschiedenen Standorten an Basisstationen an. Schalten Sie die Funktion **automatische Wahl** von Basisstationen ein  Seite 17. An welchem Standort Sie sich auch befinden, das Mobilteil sucht sich automatisch eine in Reichweite liegende Basisstation.

¹ **GAP: Generic Access Profile** = Standard für das Zusammenwirken von Mobilteilen und Basisstationen unterschiedlicher Hersteller.

12 Falls es Probleme gibt

Service-Hotline

Haben Sie Probleme mit Ihrem Telefon, kontrollieren Sie zuerst die folgenden Hinweise. Bei technischen Problemen können Sie sich an unsere Service-Hotline unter Tel. 0900 00 1675 innerhalb der Schweiz (Kosten Swisscom bei Drucklegung: CHF 2.00/min) wenden. Bei Garantieansprüchen wenden Sie sich an Ihren Fachhändler. Die Garantiezeit beträgt 2 Jahre.

Fragen und Antworten

Fragen	Antworten
Keine Verbindung zur Basisstation möglich	<ul style="list-style-type: none"> - Prüfen Sie, ob Sie sich mit dem richtigen PIN-Code an der Basisstation angemeldet haben ☞ Seite 17.
Kein Telefongespräch möglich	<ul style="list-style-type: none"> - Das Telefon ist nicht korrekt angeschlossen oder gestört. Verwenden Sie nur das mitgelieferte Telefonanschlusskabel. - Testen Sie mit einem anderen Telefon, ob Ihr Telefonanschluss in Ordnung ist. - Das Netzteil ist nicht eingesteckt oder es liegt ein totaler Stromausfall vor. - Die aufladbaren Akkus sind leer oder defekt. - Sie haben sich zu weit von der Basisstation entfernt. - Wahlverfahren falsch eingestellt ☞ Seite 16.

Verbindung abgehackt, fällt aus	<ul style="list-style-type: none"> - Sie haben sich zu weit von der Basisstation entfernt. - Falscher Aufstellungsort der Basisstation.
Das System reagiert nicht mehr	<ul style="list-style-type: none"> - Setzen Sie alle Funktionen in den Werkszustand zurück ☞ Seite 17. - Ziehen Sie kurzzeitig das Netzteil aus der Steckdose.
Die Akkus sind in kürzester Zeit leer	<ul style="list-style-type: none"> - Die Akkus sind leer oder defekt. - Stellen Sie das Mobilteil richtig auf die Basisstation. Reinigen Sie die Kontaktflächen am Mobilteil und an der Basisstation mit einem weichen trockenen Tuch. - Stellen Sie das Mobilteil für 14 Stunden in die Basisstation.
Die Rufnummernanzeige (CLIP ¹) funktioniert nicht	<ul style="list-style-type: none"> - Die Rufnummernanzeige ist ein Zusatzdienst Ihres Netzbetreibers. Bitte fragen Sie Ihren Netzbetreiber nach weiteren Informationen. - Der Anrufer hat das Übertragen seiner Rufnummer unterdrückt.

D

¹ CLIP: Calling Line Identification Presentation = Anzeige der Rufnummer eines Anrufers.

Falls es Probleme gibt

Der Anrufbeantworter nimmt keine Nachrichten auf

- Stellen Sie sicher, dass der Anrufbeantworter korrekt angeschlossen und eingeschaltet ist.
- Prüfen Sie, ob der Speicher des Anrufbeantworters voll ist. Löschen Sie ggf. Nachrichten aus dem Speicher ☞ Seite 13.

Sie können kein Memo aufzeichnen

- Prüfen Sie, ob bereits ein Memo aufgezeichnet wurde. Löschen Sie ggf. das alte Memo ☞ Seite 12..
- Prüfen Sie, ob der Speicher des Anrufbeantworters voll ist. Löschen Sie ggf. Nachrichten aus dem Speicher ☞ Seite 12.

Sie können keine Fernabfrage durchführen

- Prüfen Sie, ob Sie den richtigen Sicherheitscode für die Fernabfrage benutzen ☞ Seite 13.
- Das Telefon, das Sie für die Fernabfrage nutzen, muss auf Ton-Wahlverfahren eingestellt sein.

13 Technische Eigenschaften

Technische Daten

Merkmal	Wert
Standard	DECT¹-GAP²
Stromversorgung (Basisstation) mit Anrufbeantworter	Eingang: 220/230 V, 50 Hz Ausgang: 9 V, 500 mA
Stromversorgung (Ladestation)	Eingang: 220/230 V, 50 Hz Ausgang: 6 V, 150 mA
Reichweite	Außen: ca. 300 m Innen: ca. 50 m
Stand-by	Bis zu 120 h
Max. Gesprächsdauer	Bis zu 12 h
Aufladbare Akkus	2 x AAA NiMH 1,2 V
Wahlverfahren	Ton-Wahlverfahren Impuls-Wahlverfahren
Zulässige Umgebungstemperatur	10 °C bis 30 °C
Zulässige relative Luftfeuchtigkeit	20 % bis 75 %
Flash-Funktion	100 ms, 300 ms

¹ **DECT**: Digital Enhanced Cordless Telecommunication = Standard für kabellose Telefone.

² **GAP**: Generic Access Profile = Standard für das Zusammenwirken von Mobilteilen und Basisstationen unterschiedlicher Hersteller.

Werkseinstellungen

Die Werkseinstellungen werden über das Menü wiederhergestellt. Auf Seite 17 finden Sie die Position im Menü.

Mobilteil

Sprache	DEUTSCH
Automatische Anrufannahme	EIN
Wahlverfahren	DTMF
Melodie	1
Klingellautstärke	3
Tastenton	EIN
Hörerlautstärke	2
ECO-Mode (ECO MODE)	AUS

Basisstation

PIN-Code	0000
----------	------

Anrufbeantworter

Sicherheitscode für die Fernabfrage	000
-------------------------------------	-----

Konformitätserklärung

Dieses Gerät erfüllt die Anforderungen der EU-Richtlinie: 1999/5/EG Richtlinie über Funkanlagen und Telekommunikationsendeinrichtungen und die gegenseitige Anerkennung ihrer Konformität. Die Konformität mit der o. a. Richtlinie wird durch das CE-Zeichen auf dem Gerät bestätigt.

Die komplette Konformitätserklärung finden Sie auf der Rückseite dieser Bedienungsanleitung.



14 Pflegehinweise / Garantie

Pflegehinweise

- Reinigen Sie die Gehäuseoberflächen mit einem weichen und fusselfreien Tuch.
- Verwenden Sie keine Reinigungsmittel oder Lösungsmittel.

Garantie

SWITEL - Geräte werden nach den modernsten Produktionsverfahren hergestellt und geprüft. Ausgesuchte Materialien und hoch entwickelte Technologien sorgen für einwandfreie Funktion und lange Lebensdauer. Ein Garantiefall liegt nicht vor, wenn die Ursache einer Fehlfunktion des Gerätes bei dem Telefonnetzbetreiber oder einer eventuell zwischengeschalteten Nebenstellenanlage liegt. Die Garantie gilt nicht für die in den Produkten verwendeten Batterien, Akkus oder Akkupacks. Die Garantiezeit beträgt 24 Monate, gerechnet vom Tage des Kaufs.

Innerhalb der Garantiezeit werden alle Mängel, die auf Material- oder Herstellungsfehler zurückzuführen sind, kostenlos beseitigt. Der Garantieanspruch erlischt bei Eingriffen durch den Käufer oder durch Dritte. Schäden, die durch unsachgemäße Behandlung oder Bedienung, natürliche Abnutzung, durch falsches Aufstellen oder Aufbewahren, durch unsachgemäßen Anschluss oder Installation sowie durch höhere Gewalt oder sonstige äußere Einflüsse entstehen, fallen nicht unter die Garantieleistung. Wir behalten uns vor, bei Reklamationen die defekten Teile auszubessern, zu ersetzen oder das Gerät auszutauschen. Ausgetauschte Teile oder ausgetauschte Geräte gehen in unser Eigentum über. Schadenersatzansprüche sind ausgeschlossen, soweit sie nicht auf Vorsatz oder grober Fahrlässigkeit des Herstellers beruhen.

Sollte Ihr Gerät dennoch einen Defekt innerhalb der Garantiezeit aufweisen, wenden Sie sich bitte unter Vorlage Ihrer Kaufquittung ausschließlich an das Geschäft, in dem Sie Ihr SWITEL - Gerät gekauft haben. Alle Gewährleistungsansprüche nach diesen Bestimmungen sind ausschließlich gegenüber Ihrem Fachhändler geltend zu machen. Nach Ablauf von zwei Jahren nach Kauf und Übergabe unserer Produkte können Gewährleistungsrechte nicht mehr geltend gemacht werden.

15 Stichwortverzeichnis

A

Abhören, 13
 Abmelden, 20
 Abnehmen, 10
 Akkuladezustand, 6
 Akkus einlegen, 6
 Anmelden, 20
 Anrufannahme, 6, 10
 Anrufbeantworter, 12
 Anrufbeantworter im Telefonnetz, 15
 Anrufen, 10
 Anrufliste, 18
 Anrufübernahme, 12
 Ansagen, 12
 Aufladen, 6
 Auflegen, 10
 Aufnahmezeit, 12
 Aufzeichnen, 12
 Ausschalten, 11, 12

B

Basisstation, 5, 7, 20
 Bedienelemente, 7
 Bedienung, 8
 Bereitschaftsmodus, 9

C

CLIP, 15

D

Display, 8
 Display-Symbole, 8

E

ECO-Mode, 6
 Einschalten, 11, 12
 Energiesparmodus, 9
 Erstellen, 9
 Erweiterung, 20

F

Fehlerbehebung, 21
 Fernabfrage, 13
 Fermeinschalten, 14
 Fragen und Antworten, 21
 Funktionen, 19

G

Garantie, 24
 Gebühren, 12
 Gespräch beenden, 10
 Gesprächsdauer, 11
 Gesprächsweiterleitung, 10

H

Hauptmenü, 16
 Hinweissignal, 12
 Hörerlautstärke, 11

I

Impuls-Wahlverfahren, 19
 Inbetriebnahme, 5
 Interngespräche, 10

K

Konferenzgespräche, 11
 Konformitätserklärung, 23
 Kontrollieren, 12

L

Ladestation, 5
 Lautstärke, 12
 Löschen, 12, 13, 18

M

Makeln, 11
 Memo, 12
 Menüstruktur, 16
 Mikrofonstummschaltung, 11
 Mithören, 12
 Mobilteil, 20

N

Nachrichten, 13
 Namenseingabe, 18
 Navigationstasten, 9
 Nebenstellenanlagen, 6, 15

P

Paging, 11
 Pflegehinweise, 24
 Probleme, 21

R

R-Taste, 15
 Reichweite, 20
 Rückruf, 10
 Rücksprache, 11
 Rufnummernanzeige, 15, 18

S

Schreibweisen, 8
 Service-Hotline, 21
 Sicherheitscode, 13
 Sicherheitshinweise, 4

Speichern, 9, 18
 Strahlungsreduzierung, 6
 Stummschaltung, 11
 Suchen, 11
 Symbole, 8

T

Tastenfunktionen, 14
 Tastensperre, 11
 Technische Daten, 23
 Telefonbuch, 10, 18
 Telefonbucheinträge, 9
 Telefonieren, 10
 Temporäre Tonwahl, 18
 Texteingabe, 18
 Ton-Wahlverfahren, 19
 Tonrufanzahl, 12
 Tonrufmelodie, 11

V

Verpackungsinhalt, 5
 Verzögerung, 12
 VMWI, 15

W

Wählen, 10
 Wahlpause, 15
 Wahlverfahren, 19
 Wahlwiederholung, 10
 Weiterleitung, 10
 Werkseinstellungen, 23

Z

Zusatzdienste, 15

Table des matières

1	Consignes de sécurité	27
2	Mettre votre téléphone en service	28
3	Éléments de manipulation	30
4	Introduction	31
5	Téléphoner	33
6	Répondeur	35
7	Installations à postes supplémentaires / services supplémentaires	38
8	Structure du menu	39
9	Répertoire / Liste d'appels	41
10	Fonctions particulières	42
11	Élargissement du système téléphonique	43
12	En cas de problèmes	44
13	Caractéristiques techniques	46
14	Remarques d'entretien / Garantie	47
15	Index	48

1 Consignes de sécurité

Lisez très attentivement ce mode d'emploi.

Utilisation conforme aux prescriptions

Ce téléphone convient pour téléphoner à l'intérieur d'un réseau téléphonique. Toute autre utilisation est considérée comme non conforme à l'usage. Des modifications ou changements effectués d'un propre gré ne sont pas autorisés. N'ouvrez en aucun cas l'appareil et n'effectuez aucun essai de réparation vous-même.

Lieu d'installation

Évitez toute nuisance par la fumée, la poussière, les vibrations, les produits chimiques, l'humidité, la grande chaleur ou l'ensoleillement direct.

Ne vous servez pas du combiné dans des endroits exposés aux explosions.

Bloc secteur



Attention : N'utilisez que le bloc d'alimentation fourni avec l'appareil, d'autres pouvant endommager votre téléphone. Vous ne devez pas bloquer son accès par des meubles ou d'autres objets.

Piles rechargeables



Attention : Ne jetez pas les piles dans le feu. N'utilisez que des piles rechargeables du même type ! Veillez à une polarisation correcte ! Risque d'explosion lors de leur chargement si la polarisation est incorrecte.

Panne de courant

En cas de panne de courant, vous ne pouvez pas téléphoner avec le téléphone. Tenez à votre disposition, pour parer à de telles situations, un téléphone filaire fonctionnant sans alimentation externe en courant.

Appareils médicaux



Attention : N'utilisez pas ce téléphone à proximité d'appareils médicaux. Leur influence ne peut pas être entièrement exclue.

DECT¹- Les téléphones DECT peuvent causer un bourdonnement désagréable dans les prothèses auditives.

Élimination

Si vous ne voulez plus vous servir de votre appareil, veuillez l'apporter au centre de collecte de l'organisme d'élimination des déchets de votre commune (par ex. centre de recyclage). L'icône ci-contre signifie que vous ne devez en aucun cas jeter votre appareil dans les ordures ménagères! D'après la loi relative aux appareils électriques et électroniques, les propriétaires d'appareils usagés sont tenus de mettre tous les **appareils électriques et électroniques** usagés dans un collecteur séparé.

Éliminez les piles rechargeables auprès d'un revendeur de piles ainsi que dans des centres de collecte compétents qui tiennent à votre disposition les collecteurs appropriés correspondants.

Éliminez les **fournitures d'emballage** conformément au règlement local.

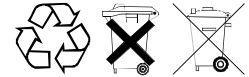

¹ **DECT:** Digital Enhanced Cordless Telecommunication = Standard pour les téléphones sans fil.

Mettre votre téléphone en service

2 Mettre votre téléphone en service

Remarques concernant la sécurité



Attention : Avant de mettre votre appareil en service, lisez impérativement les consignes de sécurité mentionnées au chapitre 1.

Contrôler le contenu de l'emballage

Les éléments suivants font partie de la livraison :

Contenu	Modèle DET			
	2171	2172 ¹	2173 ¹	2174 ¹
Base (répondeur) avec bloc d'alimentation	1	1	1	1
Chargeur avec bloc d'alimentation	-	1	2	3
Combiné	1	2	3	4
Câble de raccordement téléphonique	1	1	1	1
Piles rechargeables	2	4	6	8
Mode d'emploi	1	1	1	1

Raccorder la base



Attention : Posez la base à une distance minimum d'1 m par rapport à d'autres appareils électroniques, une distance inférieure pouvant provoquer des interactions.

Raccordez la base comme représenté sur le croquis. Pour des raisons de sécurité, n'utilisez que le bloc d'alimentation fourni avec l'appareil ainsi que le câble de raccordement téléphonique ci-joint.

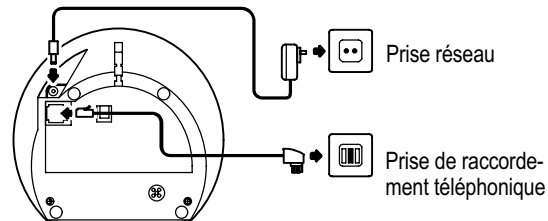

Attention : Utilisez pour la base et le répondeur le bloc d'alimentation avec les données de sortie : 9 V, 500 mA.

Raccorder le chargeur²

Raccordez le chargeur comme représenté sur le croquis. Pour des raisons de sécurité, n'utilisez que le bloc d'alimentation fourni avec l'appareil.

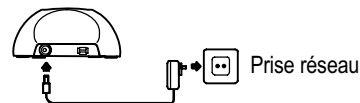

Attention : Utilisez pour le chargeur le bloc d'alimentation avec les données de sortie : 6 V, 150 mA.

¹ À l'adresse www.switel.com, vous apprendrez si ce kit téléphonique est déjà disponible à la vente.

² N'est valable que pour les kits téléphoniques avec au moins deux combinés ☎ "Contrôler le contenu de l'emballage" à la page 28.

Mettre en place les piles rechargeables

Insérez les piles rechargeables dans le compartiment à piles rechargeables ouvert. N'utilisez que des piles de type AAA NiMH 1,2 V. Veillez à une polarisation correcte ! Fermez le compartiment à piles.

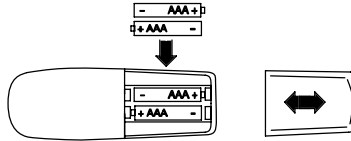

Recharger les piles rechargeables

 Pour la première mise en service, mettez le combiné sur la base / le chargeur et l'y laissez pendant **au moins** 14 heures.

Si vous avez placé le combiné correctement sur la base / le chargeur, un signal indicateur se fera entendre. Le combiné chauffe lors du chargement. C'est normal et ce n'est pas dangereux. Ne chargez pas le combiné avec des chargeurs d'un autre fabricant. Le **niveau actuel de chargement des piles** s'affiche à l'écran :



Plein



Moyen



Faible



Vide

Prise d'appel automatique

Si vous avez activé la fonction, l'appel sera automatiquement réceptionné quand vous prendrez le combiné de la base. La prise d'appel automatique s'active ou se désactive via le menu. La page 39 vous donnera la position dans le menu.

Installations à postes supplémentaires

La page 38 vous donnera de plus amples informations au cas où vous désireriez raccorder votre téléphone à une installation à postes supplémentaires.

Réduction du rayonnement (mode ÉCO)



 Réglages usine = mode ECO → ARRÊT

Vous pouvez régler le téléphone de sorte que le rayonnement soit réduit  page 40 (ECO MODE).



= ECO MODE → MARCHE.

En comparaison avec les téléphones sans fil DECT standard, le rayonnement est considérablement réduit, aussi bien en mode de communication qu'en mode veille, quand le mode ECO est activé.

 En cas de besoin, vous pouvez augmenter la portée du système téléphonique en désactivant le mode ECO  page 40 (ECO MODE → ARRÊT).

Éléments de manipulation

3 Éléments de manipulation

Dans ce mode d'emploi, les touches de votre téléphone seront représentées par la suite par des icônes encadrées standardisées. Il peut y avoir de légères différences entre les icônes des touches de votre téléphone et celles utilisées ici.

Combiné

- 1 Haut-parleur
- 2 Écran
- 3 Vers le haut / Liste d'appels
- 4 Répétition automatique des derniers numéros / Continuer
- 5 Touche de raccrochement / Interrupteur marche/arrêt
- 6 Pavé numérique
- 7 Touche # / Verrouillage du clavier
- 8 Communication interne / Conférence
- 9 Mettre le microphone sur silencieux / Effacer
- 10 Microphone
- 11 Touche R (Flash)
- 12 Touche */ Désactiver la sonnerie d'appel / Numérotation temporaire par tonalité
- 13 Vers le bas / Répertoire
- 14 Touche de communication
- 15 Touche de menu / Confirmation

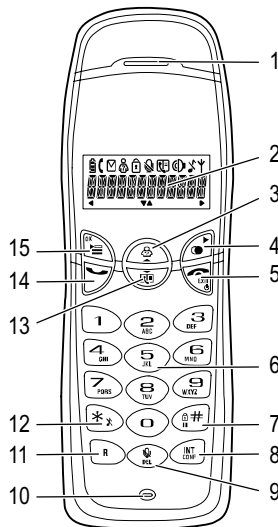

Base (répondeur)

- 1 Répondeur marche / arrêt
- 2 Chercher un combiné (paging)
- 3 Réglage du volume
- 4 Reproduction/ Stop
- 5 Sauter en arrière/ Signal indicateur
- 6 Sauter en avant/ Écoute amplifiée marche / arrêt
- 7 Microphone
- 8 Effacer
- 9 Écouter une annonce / Enregistrer une annonce
- 10 Écran
- 11 Enregistrer un mémo
- 12 Haut-parleur

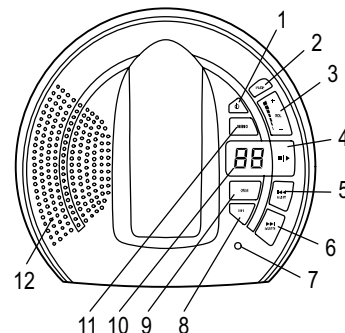

Chargeur¹

- 1 Contacts de chargement

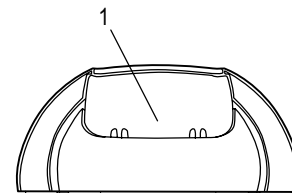













¹ N'est valable que pour les kits téléphoniques avec au moins deux combinés

"Contrôler le contenu de l'emballage" à la page 28.





4 Introduction











Dans ce chapitre, vous trouverez des informations de base vous expliquant comment vous servir du mode d'emploi et du téléphone.

Mode de représentation dans le mode d'emploi

Visualisation	Description
	Visualisation des touches
	Appuyer brièvement sur la touche représentée
2 sec. 	Appuyer 2 secondes sur la touche représentée
Maintenir 	Maintenir appuyée la touche représentée
Relâcher 	Relâcher la touche représentée
	Saisir des chiffres ou des lettres
	Le combiné sonne
	La base sonne
	Prendre le combiné de la base
	Poser le combiné sur la base
NOM? 	Visualisation des textes de l'écran
	Visualisation des icônes de l'écran

Icônes et textes sur l'écran du combiné

Icône	Description
	Constant : affichage de la capacité des piles. Clignotant : rechargez les piles rechargeables. Segments continus : les piles rechargeables se rechargent  page 29.
	Constant : vous passez une communication. Clignotant : un appel vous parvient  page 33.

	Constant : vous vous trouvez dans la liste d'appels. De nouveaux appels se trouvent dans la liste d'appels  page 41.
 ou	À gauche ou à droite se trouvent d'autres chiffres du numéro affiché.
	La sonnerie d'appel est débranchée  page 34.
	Le verrouillage du clavier est activé  page 34.
	Répondeur dans le réseau téléphonique. Service supplémentaire VMWI ¹ de votre opérateur  page 38.
	Le microphone est mis sur silencieux  page 34.
Y	Constant : la liaison avec la base est bonne. Clignotant : la liaison avec la base est interrompue. Rapprochez vous de la base.

¹ **VMWI**: Visual Message Waiting Indication = Affichage optique de nouveaux messages.

Introduction

Mode veille

Toutes les descriptions dans ce mode d'emploi partent du principe que le combiné se trouve en mode veille. Vous parvenez au mode veille en appuyant sur la touche .

Mode économie d'énergie

Au bout d'un certain temps en mode veille, le combiné passe en mode économie d'énergie. L'écran n'est maintenant plus éclairé. Appuyez sur une touche quelconque pour activer le mode veille.



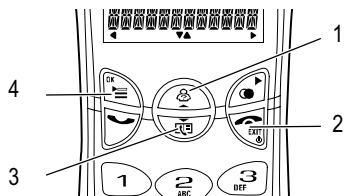









Touches de navigation



Touche	En mode veille	Dans le menu
1	- Ouvrir la liste d'appels	- Feuilleter dans les menus
2	- Allumer, éteindre le combiné	- Reculer d'une position - Interrompre les opérations de programmation et de sauvegarde
3	- Ouvrir le répertoire	- Feuilleter dans les menus
4	- Ouvrir le menu principal	- Ouvrir le menu affiché / Ouvrir une option

Navigation dans le menu













Vous pouvez accéder à toutes les fonctions via différents menus. Vous trouverez comment parvenir à la fonction de votre choix dans la structure du menu  page 39.

	Ouvrir le menu principal
 ou 	Sélectionner le sous-menu de votre choix
	Ouvrir le sous-menu
 ou 	Sélectionner la fonction de votre choix
	Ouvrir la fonction
 ou 	Sélectionner le réglage de votre choix
	Saisir des chiffres ou des lettres via le pavé numérique.
	Confirmer la saisie
	Reculer d'une position

 Chaque opération est automatiquement interrompue si vous n'effectuez pas de saisie dans les 30 secondes.

Créer des enregistrements dans le répertoire - exemple

L'exemple **Créer des enregistrements dans le répertoire** vous explique comment naviguer dans les menus et saisir des données. Pour tous les réglages, procédez comme dans cet exemple.

	Ouvrir le menu
 ou 	
 , 	Sélectionner la fonction et confirmer
 ou 	
 , 	Sélectionner la fonction et confirmer
 , 	Saisir le nom (max. 12 positions) et confirmer
 , 	Saisir le numéro d'appel (max. 20 chiffres) et confirmer

5 Téléphoner

Prendre un appel

,  ou  Prendre un appel

Terminer la communication

 ou  Terminer la communication

Appeler

 Saisir le numéro d'appel (max. 20 chiffres)



 En cas de saisie erronée, effacer le dernier chiffre

 Établir la communication

 Vous pouvez aussi appuyer d'abord sur la touche de communication ; vous obtenez ainsi la tonalité. Les chiffres saisis de votre numéro d'appel seront immédiatement composés. La correction individuelle de chiffres du numéro d'appel n'est pas possible quand la communication est établie de cette manière.

Répétition automatique des derniers numéros



Votre téléphone enregistre le dernier numéro d'appel composé.

  Déclencher la répétition automatique des derniers numéros et établir la communication

Rappeler des appels entrés

Votre téléphone enregistre 20 appels dans une liste d'appels.



 Ouvrir la liste d'appels

 ou ,  Sélectionner l'enregistrement et établir la communication

Composer des numéros à partir du répertoire

Vous devez avoir enregistré des numéros d'appel dans le répertoire  page 32 et page 41.



 Ouvrir le répertoire

 ou ,  Sélectionner l'enregistrement et établir la communication

Téléphoner en interne¹

Téléphoner en interne



Vous devez avoir déclaré deux ou plusieurs combinés (CB1, CB2, ...) sur votre base afin de pouvoir téléphoner en interne gratuitement.

CB1:  , par ex.  Sélectionner le numéro d'appel interne du combiné de votre choix

CB2:  Prendre la communication interne sur l'autre combiné



CB1 / CB2:  Terminer la communication interne

Transférer des communications externes en interne

CB1:  , par ex.  Sélectionner le numéro d'appel interne pendant la communication externe

CB2:  Prendre la communication interne sur l'autre combiné

CB1:  Transférer la communication



 Si le combiné appelé devait ne pas répondre, vous pouvez reprendre la communication externe en appuyant sur la touche .

¹ Téléphoner en interne n'est possible qu'avec au moins deux combinés  "Contrôler le contenu de l'emballage" à la page 28.

Téléphoner

Intercommunication / Va-et-vient

Pendant une communication externe, vous pouvez sélectionner un autre combiné pour intercommuniquer. Le correspondant externe sera maintenu en ligne pendant que vous parlez avec le correspondant interne. Vous pouvez répéter cette opération autant de fois que vous le désirez.



CB1: , par ex.  Sélectionner le numéro d'appel interne pendant la communication externe

CB2:  Prendre la communication interne sur l'autre combiné

CB1:  Changer de correspondant

Comment mener des conférences téléphoniques

Une communication externe peut être transformée en conférence téléphonique avec un autre correspondant interne.

CB1: , par ex.  Sélectionner le numéro d'appel interne pendant la communication externe



CB2:  Prendre la communication interne sur l'autre combiné

CB1: 2 sec.  Démarrer la conférence

CB1 / CB2:  Terminer la conférence

Régler le volume sonore de l'écouteur

Vous disposez de 3 sensibilités pour régler le volume pendant une communication.

 ou  Sélectionner le volume sonore de votre choix

Affichage de la durée de la communication

Pendant une communication, sa durée s'affiche en minutes et secondes.

Mettre le microphone du combiné sur silencieux

Vous pouvez activer et désactiver le microphone du combiné pendant une communication téléphonique.

 Désactiver le microphone (mettre sur silencieux)

 Activer le microphone

Verrouillage du clavier

Le verrouillage évite que vous n'appuyiez sur des touches par inadvertance.

2 sec.  Activer le verrouillage du clavier

 Lorsque le verrouillage du clavier est activé, vous pouvez comme d'habitude réceptionner des appels entrants.

2 sec.  Désactiver le verrouillage du clavier

Mélodie de sonnerie d'appel du combiné

Vous pouvez désactiver la mélodie de la sonnerie d'appel du combiné.

2 sec.  Désactiver la mélodie de la sonnerie d'appel

 Les communications entrantes sont maintenant signalées par la base et non plus par le combiné.

2 sec.  Activer la mélodie de la sonnerie d'appel

Comment chercher le combiné (Paging)

Si vous avez égaré votre combiné, vous pouvez le retrouver facilement via un son de recherche.

   Démarrer le son de recherche

  ou  Arrêter le son de recherche

Allumer et éteindre le combiné

Pour ménager les piles rechargeables, vous pouvez éteindre le combiné.

2 sec.  Éteindre le combiné

2 sec.  Allumer le combiné

6 Répondeur

Activer / désactiver le répondeur



Brancher / débrancher le répondeur

Temps d'enregistrement maximal

Le répondeur enregistre jusqu'à 60 messages. La durée d'enregistrement maximum est de 7 minutes. La longueur maximale de chaque message est de 2 minutes. Si la capacité de mémorisation de nouveaux messages est épuisée, plus aucun appel ne peut être enregistré.

Régler le volume sonore

Vous pouvez régler le volume sonore sur 5 sensibilités.

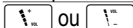

Régler le volume sonore

Régler le nombre de sonnerie d'appel (report)

Vous pouvez choisir entre 2 à 7 sonneries et le paramétrage **Économiseur de taxes** pour la consultation préalable à distance exonérée de taxes. La consultation préalable à distance exonérée de taxes vous permet de constater si de nouveaux messages se trouvent sur votre répondeur.

- S'il y a de nouveaux messages sur votre répondeur, votre appel sera pris dès la 2ème sonnerie.
- Si aucun message n'a été enregistré, votre appel ne sera pris qu'au bout de la 4ème sonnerie. Raccrochez avant la 4ème sonnerie. Ainsi vous ne payerez pas de taxes.



Vous opérez ce paramétrage sur votre combiné page 39 !

Vous trouverez d'autres informations sur la consultation à distance page 36.

Signal indicateur dans le cas de messages enregistrés

Si un nouveau message ou un mémo ont été enregistrés, un signal sonore se fait entendre toutes les minutes.



Activer / désactiver le signal indicateur

Écoute amplifiée de messages entrants

Vous pouvez, par l'écoute amplifiée, entendre les appels entrants sans pour autant répondre à l'appel.



Activer / désactiver l'écoute amplifiée

Intercepter un appel

Si le répondeur a déjà réceptionné un appel, vous pouvez intercepter celui-ci. L'enregistrement du message est, dans ce cas, interrompu.



Prendre un appel

Enregistrer / contrôler ou effacer une annonce

Votre répondeur met à votre disposition deux textes d'annonce prédéfinis. Après le texte d'annonce 1, il est possible de laisser un message. Dans le cas du texte d'annonce 2, il s'agit d'une annonce seulement après laquelle il n'est pas possible de laisser de message. Vous pouvez remplacer le texte d'annonce 1 par un texte d'annonce personnel. Le texte d'annonce 2 n'est pas modifiable. Si la mémoire du répondeur est pleine, c'est le texte d'annonce 2 qui se fera automatiquement entendre.

Enregistrer une annonce

La longueur de l'annonce personnelle ne doit pas dépasser les 40 secondes.

2 sec. **OGM**

Démarrer l'enregistrement



Enregistrer l'annonce et confirmer

Contrôler l'annonce actuellement paramétrée

OGM

Écouter l'annonce

Suppression d'une annonce personnelle et retour à l'annonce standard

Si vous effacez votre annonce personnelle, l'annonce standard préenregistrée est de nouveau activée.

OGM

Écouter l'annonce

DEL

Effacer l'annonce



Répondeur

Enregistrer / écouter ou effacer un mémo

Un mémo est une information qui peut être écoutée comme un message entré. Vous pouvez enregistrer un mémo au maximum.

Enregistrement d'un mémo

La longueur du mémo ne doit pas dépasser les 2 minutes.

2 sec. MEMO	Démarrer l'enregistrement
 	Enregistrer le mémo et confirmer

Écouter le mémo

MEMO	Écouter le mémo
-------------	-----------------





Effacer le mémo

MEMO	Écouter le mémo
DEL	Effacer le mémo

Écouter / Effacer les messages enregistrés

Écouter des messages

Quand un mémo a été enregistré, celui-ci est reproduit avant les messages entrés. Les messages enregistrés sont reproduits dans l'ordre dans lequel ils sont entrés.

2 sec. 	Écouter de nouveaux messages
	Écouter tous messages
	Arrêter la reproduction
	Répéter le message
	Message suivant

Effacer un message

	Écouter le message à effacer
DEL	Effacer le message

Supprimer tous les messages / mémos

Tous les messages / mémos s'effacent. Les nouveaux messages / mémos sont conservés.

















2 sec. DEL	Démarrer l'effacement
DEL	Effacer les messages / mémos

La consultation à distance



Vous pouvez appeler votre répondeur pour écouter des messages et opérer d'autres fonctions à condition que vous ayez un téléphone à fonctionnalité de numérotation par tonalité.

Le code de sécurité pour la consultation à distance

Pour pratiquer la consultation à distance, vous devez saisir un code de sécurité. Celui-ci est paramétré à l'usine sur le "000".

	Ce réglage s'effectue sur le combiné !
	Ouvrir le menu
 ou 	
REGLAGES , 	Sélectionner le sous-menu et confirmer
 ou 	
RÉPONDEUR , 	Sélectionner le sous-menu et confirmer
 ou 	
CODE IAD , 	Sélectionner la fonction et confirmer
 , 	Saisir l'ancien code PIN
 , 	Saisir le nouveau code PIN
 , 	Saisir le nouveau code PIN

Démarrer la consultation à distance

	Composer le numéro d'appel personnel
 , 	Pendant l'annonce, appuyer sur la touche et saisir le code de sécurité

 Si la saisie est erronée, vous entendrez à nouveau l'annonce du répondeur. Si le code de sécurité a été saisi trois fois de manière erronée, la ligne est automatiquement coupée.

Vous avez maintenant la possibilité d'exécuter d'autres fonctions

 Tableau de fonctions des touches.

Brancher à distance le répondeur



Composer le numéro d'appel personnel



Si vous avez oublié de brancher votre répondeur, votre appel ne sera réceptionné qu'au bout de 10 sonneries.



Appuyer sur ces touches pendant l'annonce et saisir le code PIN



Brancher / débrancher le répondeur

Vous avez maintenant la possibilité d'exécuter d'autres fonctions

Tableau de fonctions des touches.

Fonctions des touches de la consultation à distance



La consultation à distance est automatiquement interrompue si vous n'effectuez pas de saisie dans les 8 secondes.

Les fonctions des touches dépendent du mode dans lequel vous vous trouvez. Le tableau suivant vous offre une vue d'ensemble de toutes les fonctions de chaque touche.

Touche	Fonctions	Fonctions pendant l'écoute d'un message
		Écouter le message précédent
	Écouter des messages	Écouter à nouveau le message qui passe
		Écouter le message suivant
	Écouter le mémo	
	Terminer l'action	Arrêter le message en cours
	Écouter l'annonce	
	Enregistrement d'un mémo	
	Brancher / débrancher le répondeur	
	Enregistrer une annonce	
		Effacer le message en cours
,	Supprimer tous les messages	
	Raccrocher pour terminer la consultation à distance.	

Installations à postes supplémentaires / services supplémentaires

7 Installations à postes supplémentaires / services supplémentaires

Touche R sur des installations à postes supplémentaires

Si votre téléphone est raccordé à une installation à postes supplémentaires, vous pouvez, via la **touche R**, tirer profit de certaines fonctions comme par ex. le transfert d'appels et le rappel automatique. Veuillez lire le mode d'emploi de votre installation à postes supplémentaires pour connaître le temps de flash que vous devez paramétrer pour tirer profit de ces fonctions. Votre revendeur, auprès duquel vous avez acheté l'installation, vous informera si votre téléphone fonctionne impeccablement sur ce genre d'installation. Vous réglez la date et l'heure via le menu. La page 39 vous donnera la position dans le menu.

Pause de numérotation

Dans le cas d'installations à postes supplémentaires, il est nécessaire de composer auparavant un code réseau pour obtenir la tonalité. Sur quelques installations à postes supplémentaires plus anciennes, cela dure quelques instants jusqu'à ce que vous entendiez la tonalité. Pour ces installations à postes supplémentaires, une pause de numérotation peut être insérée après le code réseau afin de pouvoir continuer à numéroté directement sans attendre la tonalité.

2 sec.  Insérer une pause de numérotation

Après le code réseau, le numéro est composé au bout d'un temps déterminé.

 La pause peut également être enregistrée lors de la saisie de numéros d'appel dans le répertoire.

Touche R et services supplémentaires

Votre téléphone supporte des services supplémentaires de votre opérateur, comme par ex. le va-et-vient, la signalisation d'appel en instance et la conférence. Via la **touche R**, vous pouvez tirer profit de ces services. Demandez à votre opérateur quel temps de flash vous devez paramétrer pour tirer profit des services supplémentaires. Adressez-vous également à lui pour la déconnexion de ces services. Vous réglez la date et l'heure via le menu. La page 39 vous donnera la position dans le menu.

Affichage du numéro d'appel (CLIP¹)



L'affichage du numéro d'appel est un service supplémentaire de votre opérateur. Demandez-lui de plus amples informations.

Si cette fonction est disponible sur votre ligne téléphonique, le numéro d'appel du correspondant vous sera déjà affiché quand le téléphone sonnera. Si votre correspondant a bloqué la transmission de son numéro, un message correspondant sera affiché. Le numéro d'appel ne peut pas être affiché et ne peut donc pas être enregistré dans la liste d'appels.

Répondeur dans le réseau téléphonique





Le répondeur dans le réseau téléphonique est un service supplémentaire offert par de nombreux opérateurs. Si votre opérateur tient un répondeur à votre disposition dans le réseau téléphonique, une icône sous forme de lettre vous informera de nouveaux messages (**VMWI**²). Vous ne pouvez disposer de cette fonction que si votre opérateur offre ce service. Veuillez lui demander de plus amples informations.



¹ **CLIP**: Calling Line Identification Presentation = Affichage du numéro d'appel d'un correspondant.

² **VMWI** : Visual Message Waiting Indication = Affichage optique de nouveaux messages.

8 Structure du menu

Menu principal

Vous parvenez au menu principal en appuyant sur la touche . Ensuite, sélectionnez un enregistrement en appuyant sur les touches  /  et confirmez votre sélection avec la touche .

CONTACTS	AJOUTER	NOM?	NUMÉRO?
	MODIFIER		
	EFFACER	 / 	CONFIRMER?
	SUPPRTOU	CONFIRMER?	
AFFICHAGE	NOM COMBINÉ		
	ÉCLAIRAGE	MARCHE	ARRÊT
	LANGUE	FRANCAIS, ENGLISH, ITALIANO, DEUTSCH	
SONS / AUDIO	COMBINE	MÉLODIE	MÉLODIE 1-10
	BASE	VOLUME	SILENCE, 1-5
		MÉLODIE	MÉLODIE 1-10
	BIP TOUCHES	VOLUME	SILENCE, 1-5
		MARCHE	ARRÊT
	BIP CONFIRM	MARCHE	ARRÊT
	REGLAGES	RÉPONDEUR	DÉLAI SONN
DÉCRO AUTO		CODE IAD	NOUVEAU CODE CONFIRMEZ:
		MARCHE	ARRÊT
TYPE DE NUM		FRÉQ VOCALE	DÉCIMALE
R		R 1-2	(100 ms / 300 ms)



Structure du menu

↙ APPAIRAGE	APPAIRAGE	CODE (0000)	1 2 3 4	CHERCHE BASE
	CHOISIR BASE	AUTO	BASE 1-4	
	SUPPCOMBINÉ	COMBINÉ 1-4	CODE	
	CODE BASE	CODE	NOUVEAU CODE	CONFIRMEZ:
	ECO MODE	MARCHE	ARRÊT	
	RESET	CODE		

9 Répertoire / Liste d'appels



Répertoire

Vous pouvez enregistrer 20 numéros d'appel et les noms y afférant dans le répertoire.

- Saisissez toujours les numéros d'appel avec l'indicatif afin que le téléphone puisse aussi attribuer les communications locales à un enregistrement du répertoire.
- Si la capacité de mémoire est épuisée, l'écran affiche le message suivant lors de la prochaine sauvegarde. Afin de créer à nouveau de la place, vous devez d'abord effacer un autre enregistrement.
- Les enregistrements du répertoire sont rangés par ordre alphabétique. Pour accéder directement à l'enregistrement désiré, appuyez sur l'initiale correspondante.

Saisir le nom

Des lettres sont gravées sur les touches numériques. En appuyant plusieurs fois sur la touche correspondante, vous pouvez saisir des lettres et des chiffres.

	Entrer des espaces
	Effacer

 Si un nom existe déjà dans le répertoire, le message **NOM DÉJÀ** s'affiche. Modifiez le nom.

 Pour saisir deux fois la même lettre, appuyez sur la lettre correspondante. Attendez que le curseur soit passé derrière la lettre. Puis tapez la lettre une nouvelle fois.

Liste d'appels



Dans l'ensemble, 20 numéros d'appel sont enregistrés dans la liste d'appels.



L'affichage du numéro d'appel (**CLIP**¹) est un service optionnel de votre opérateur. Votre téléphone affiche les numéros d'appel à l'écran si votre opérateur supporte ce service. Veuillez lui demander de plus amples informations.





¹ **CLIP**: Calling Line Identification Presentation = Affichage du numéro d'appel d'un correspondant.



Afficher des numéros de la liste d'appels



 ,  ou  Ouvrir la liste d'appels et sélectionner l'enregistrement



Sauvegarder des numéros d'appel dans le répertoire à partir de la liste d'appels

Vous pouvez enregistrer un numéro d'appel dans le répertoire directement à partir de la liste d'appels.

 ,  ou  ,  Ouvrir la liste d'appels et sélectionner l'enregistrement

 ou  **MÉMORISER** ,  Démarrer la sauvegarde





 ,  Saisir le nom, confirmer

 ,  Le cas échéant, traiter le numéro, confirmer



 Dès que le numéro d'appel est enregistré avec un nom dans le répertoire, le nom saisi apparaît dans la liste d'appels.

Effacer des numéros de la liste d'appels



Effacer des numéros individuels

 ,  ou  ,  Ouvrir la liste d'appels et sélectionner l'enregistrement



 ou  **EFFACER** ,  Activer l'opération d'effacement

 ou  Confirmer l'opération d'effacement ou annuler l'opération

Effacer tous les numéros

 ,  Ouvrir la liste d'appels

 ou  **SUPPRTOU** ,  Activer l'opération d'effacement

 ou  Confirmer l'opération d'effacement ou annuler l'opération

Fonctions particulières

10 Fonctions particulières

Système de numérotation

Vous pouvez utiliser votre téléphone tant avec les centrales téléphoniques analogiques (numérotation par impulsions) qu'avec les nouvelles centrales téléphoniques numériques (numérotation par tonalité). Le système de numérotation est programmé via le menu. La page 39 vous donnera la position dans le menu.

Numérotation temporaire par tonalité

Si vous ne pouvez utiliser votre téléphone qu'avec la numérotation par impulsions, vous n'avez pas besoin de renoncer aux avantages de la numérotation par tonalité (par ex. : consultation d'un répondeur dans le réseau téléphonique). Vous pouvez passer à la numérotation par tonalité pendant que vous passez une communication.

1 sec.

Appuyer sur la touche pendant la communication

Le téléphone commute automatiquement en numérotation par impulsions quand la communication est terminée.

11 Élargissement du système téléphonique

Le mode standard **GAP**¹ international normé règle la compatibilité entre les combinés et les bases de fabricants différents. Il est ainsi possible d'intégrer ensemble des appareils SWITEL et des appareils d'autres fabricants dans un système téléphonique. Il est toutefois possible que certaines fonctions ne soient plus disponibles.

Plusieurs combinés

Vous pouvez déclarer 4 combinés sur votre base.

Déclaration de combinés

Avant de déclarer un combiné, vous devez mettre la base en mode de déclaration.

4 sec. **PAGE** / (●)), entendre Démarrer le mode de déclaration

Déclarez maintenant le combiné ☞ page 40. Pour la déclaration, utilisez le code PIN actuellement paramétré ☞ page 40.

Après la déclaration, le combiné reçoit un numéro d'appel interne. Ce numéro d'appel interne s'affiché à l'écran.



Pour déclarer des combinés d'autres fabricants, veuillez lire leur mode d'emploi.

Annulation de combinés



Vous ne pouvez annuler un combiné d'une base que par un autre qui est déclaré sur cette base.

Les combinés sont annulés via le menu. La page 40 vous donnera la position dans le menu.

Plusieurs bases

Vous pouvez augmenter la portée de votre combiné si vous le déclarez sur plusieurs bases. Vous pouvez le déclarer simultanément sur 4 bases différentes. Chaque base a besoin d'une prise téléphonique individuelle. Ces raccordements peuvent porter le même numéro d'appel ou bien des numéros différents.



Les communications en cours ne peuvent pas être transférées d'une base à l'autre.

Augmentation de la portée

Placez vos bases de telle sorte que la portée de chacune se recoupe. Testez la portée de vos combinés, des obstacles dans les bâtiments pouvant la restreindre. Déclarez le combiné sur toutes les bases. Activez la fonction **Numérotation automatique** des bases ☞ page 40. Le combiné cherche automatiquement la base la plus proche ayant la meilleure liaison.



En cas de besoin, vous pouvez augmenter la portée du système téléphonique en désactivant le mode ECO ☞ page 40 (ECO MODE → ARRÊT).

Mobilité grâce à différents emplacements

Déclarez le combiné sur les bases dans différents endroits. Activez la fonction **Numérotation automatique** des bases ☞ page 40. À quelque endroit que vous vous trouviez, le combiné cherche automatiquement une base se trouvant dans la portée.

¹ **GAP**: **Generic Access Profile** = Standard pour l'action conjointe de combinés et de bases de fabricants différents.

En cas de problèmes

12 En cas de problèmes

Hotline de service

Si vous avez des problèmes avec votre téléphone, contrôlez d'abord les indications suivantes. En cas de problèmes techniques, vous pouvez vous adresser à notre hotline de service en appelant le numéro 0900 00 1675 à l'intérieur de la Suisse (frais Télécom à la date d'impression de ce manuel : 2.00 CHF/min). Si vous jouissez des droits de garantie, adressez-vous à votre revendeur. La durée de la garantie est de 2 ans.

Questions et réponses

Questions	Réponses
Pas de liaison possible avec la base	- Contrôlez que vous vous êtes déclaré sur la base avec le code PIN correct ☞ page 40.
Pas de communication téléphonique possible	- Le téléphone n'est pas raccordé correctement ou est perturbé. N'utilisez que le câble de raccordement téléphonique fourni avec l'appareil. - Testez avec un autre téléphone si votre raccordement téléphonique fonctionne. - Le bloc d'alimentation n'est pas branché ou il y a une panne totale de courant. - Les piles rechargeables sont vides ou défectueuses. - Vous vous êtes trop éloigné de la base. - Le système de numérotation est mal paramétré ☞ page 39.

La ligne est hachée, se coupe	- Vous vous êtes trop éloigné de la base. - Mauvais lieu d'installation de la base.
Le système ne réagit plus	- Remettez toutes les fonctions en configuration usine ☞ page 40. - Retirez temporairement le bloc d'alimentation de la prise de courant.
Les piles rechargeables se vident très rapidement	- Les piles rechargeables sont vides ou défectueuses. - Posez le combiné correctement sur la base. Nettoyez les surfaces de contact du combiné et de la base avec un chiffon doux et sec. - Mettez le combiné sur la base pour une durée de 14 heures.
L'affichage du numéro d'appel (CLIP ¹) ne fonctionne pas	- L'affichage du numéro d'appel est un service supplémentaire de votre opérateur. Veuillez lui demander de plus amples informations. - Le correspondant a bloqué la transmission de son numéro d'appel.
Le répondeur ne prend pas de message	- Assurez-vous que le répondeur est correctement raccordé et branché. - Contrôlez si la mémoire du répondeur est pleine. Effacez le cas échéant des messages se trouvant dans la mémoire ☞ page 36.

¹ **CLIP**: Calling Line Identification Presentation = Affichage du numéro d'appel d'un correspondant.

Vous ne pouvez pas enregistrer de mémo	<ul style="list-style-type: none">- Contrôlez si un mémo a déjà été enregistré. Effacez le cas échéant l'ancien mémo ☞ page 36.- Contrôlez si la mémoire du répondeur est pleine. Effacez le cas échéant des messages se trouvant dans la mémoire ☞ page 36.
Vous ne pouvez pas consulter à distance	<ul style="list-style-type: none">- Contrôlez si que vous utilisez le code de sécurité correct pour la consultation à distance ☞ page 36.- Le téléphone que vous utilisez pour la consultation à distance doit être réglé sur la numérotation par tonalité.

Caractéristiques techniques

13 Caractéristiques techniques

Caractéristiques techniques

Caractéristique	Valeur
Standard	DECT¹-GAP²
Alimentation en courant (base) avec répondeur	Entrée : 220/230 V, 50 Hz Sortie : 9 V, 500 mA
Alimentation en courant (chargeur)	Entrée : 220/230 V, 50 Hz Sortie : 6 V, 150 mA
Portée	Extérieur : env. 300 m Intérieur : env. 50 m
Mode de veille	Jusqu'à 120 h
Durée max. de communication	Jusqu'à 12 h
Piles rechargeables	2 x AAA NiMH 1,2 V
Système de numérotation	Numérotation par tonalité Numérotation par impulsions
Température ambiante autorisée	10 °C à 30 °C
Humidité atmosphérique relative autorisée	20 % à 75 %
Fonction de flash	100 ms, 300 ms

¹ **DECT**: Digital Enhanced Cordless Telecommunication = Standard pour les téléphones sans fil.

² **GAP**: Generic Access Profile = Standard pour l'action conjointe de combinés et de bases de fabricants différents.

Réglages usine

Les paramétrages en usine sont rétablis via le menu. La page 40 vous donnera la position dans le menu.

Combiné

Langue	FRANCAIS
Prise d'appel automatique	MARCHE
Système de numérotation	FRÉQ VOCALE
Mélodie	1
Volume de la sonnerie	3
Son des touches	MARCHE
Volume sonore de l'écouteur	2
mode ÉCO (ECO MODE)	ARRÊT

Base

Code PIN	0000
----------	------

Répondeur

Code de sécurité pour la consultation à distance	000
--	-----

Déclaration de conformité

Cet appareil répond aux exigences des directives de l'union européenne (UE) :

1999/5/CE Directive sur les installations de radio et de télécommunication et la reconnaissance réciproque de leur conformité. La conformité à la directive ci-dessus est confirmée par le signe CE placé sur l'appareil.

Pour la déclaration de conformité complète, veuillez utiliser le téléchargement gratuit de notre site Internet www.switel.com.



14 Remarques d'entretien / Garantie

Remarques d'entretien

- Nettoyez les surfaces du boîtier avec un chiffon doux et non pelucheux.
- N'utilisez pas de produits d'entretien ou de solvant.

Garantie

Les appareils SWITEL sont fabriqués selon les procédés les plus modernes et sont contrôlés. Des matériaux sélectionnés et des technologies de pointe ont pour effet un fonctionnement irréprochable et une longue durée de vie. La garantie ne rentre pas en jeu si l'exploitant du réseau téléphonique ou une installation à postes supplémentaires éventuellement intercalée est responsable du dysfonctionnement de l'appareil. La garantie n'est pas valable pour les piles, les piles rechargeables ou les packs de piles rechargeables utilisés dans les produits. La durée de garantie est de 24 mois à partir de la date d'achat.

Pendant la période de garantie, tous les défauts dus à des vices de matériel ou de fabrication seront éliminés gratuitement. Le droit à la garantie expire en cas d'intervention de l'acheteur ou de tiers. Les dommages provenant d'un maniement ou d'une manipulation incorrects, d'une usure naturelle, d'une mauvaise mise en place ou d'une mauvaise conservation, d'un raccordement ou d'une installation incorrects ainsi que d'un cas de force majeure ou autres influences extérieures sont exclus de la garantie. En cas de réclamations, nous nous réservons le droit de réparer, de remplacer les pièces défectueuses ou de d'échanger l'appareil. Les composants remplacés ou les appareils échangés deviennent notre propriété. Les demandes de dommages et intérêts sont exclues tant qu'elles ne reposent pas sur l'intention ou une négligence grossière du fabricant.

Si votre appareil devait malgré tout présenter une défectuosité pendant la période de garantie, veuillez vous adresser, muni de la quittance d'achat, exclusivement au magasin où vous avez acheté votre appareil SWITEL. Tous les droits de garantie basés sur ces dispositions ne peuvent être revendiqués qu'auprès de votre revendeur. À l'échéance des deux ans après l'achat et la remise de nos produits, les droits en matière de garantie ne peuvent plus être revendiqués.

Index

15 Index

A

Activer, 35
Affichage du numéro d'appel, 38
Afficher des numéros d'appel, 41
Allumer, 34
Annonce, 35
Annulation, 43
Appeler, 33

B

Base, 28, 30, 43
Brancher à distance, 37

C

Caractéristiques techniques, 46
Chargeur, 28
CLIP, 38
Code de sécurité, 36
Combiné, 43
Comment chercher le combiné, 34
Communications internes, 33
Composer un numéro, 33
Conférences téléphoniques, 34
Consignes de sécurité, 27
Consultation à distance, 36
Contenu de l'emballage, 28
Contrôler, 35, 36
Créer, 32

D

Déclaration, 43
Déclaration de conformité, 46
Décrocher, 33
Désactivation du micro, 34
Désactiver, 35
Durée de la communication, 34

E

Écoute amplifiée, 35
Écouter, 36
Écran, 31
Effacer, 35, 36, 41
Élargissement, 43
Éléments de manipulation, 30
Emploi, 31
Enregistrements du répertoire, 32
Enregistrer, 35, 36
Éteindre, 34

F

Fonctions, 42
Fonctions des touches, 37

G

Garantie, 47

H

Hotline de service, 44

I

Icône d'écran, 31
Icônes, 31
Installations à postes supplémentaires, 29, 38
Interception d'appel, 35
Intercommunication, 34

L

Liste d'appels, 41

M

Mélodie de sonnerie d'appel, 34
Mémo, 36
Menu principal, 39
Messages, 36
Mettre en place les piles rechargeables, 29
Mise en service, 28
Mise sur silencieux, 34
Mode ÉCO, 29
Mode économie d'énergie, 32
Mode veille, 32

N

Niveau de chargement des piles, 29
Nombre de sonneries, 35
Notations, 31
Numérotation par impulsions, 42
Numérotation par tonalité, 42
Numérotation temporaire par tonalité, 42

P

Paging, 34
Pause de numérotation, 38
Portée, 43
Prise d'appel, 29, 33
Problèmes, 44

Q

Questions et réponses, 44

R

Raccrocher, 33
Rappel, 33
Rechargement, 29
Réduction du rayonnement, 29
Réglage de la langue, 35

Réglages usine, 46
Remarques d'entretien, 47
Répertoire, 33, 41
Répétition automatique des derniers numéros, 33
Répondeur, 35
Répondeur dans le réseau téléphonique, 38
Report, 35

S

Saisie de nom, 41
Saisie de texte, 41
Sauvegarder, 32, 41
Services supplémentaires, 38
Signal indicateur, 35
Structure du menu, 39
Suppression d'erreurs, 44
Système de numérotation, 42

T

Taxes, 35
Téléphoner, 33
Temps d'enregistrement, 35
Terminer la communication, 33
Touche R, 38
Touches de navigation, 32
Transfert, 33
Transfert de la communication, 33

V

Va-et-vient, 34
Verrouillage du clavier, 34
VMWI, 38
Volume, 35
Volume sonore de l'écouteur, 34

1	Indicazioni di sicurezza	50
2	Mettere in funzione il telefono	51
3	Elementi di comando	53
4	Informazioni introduttive	54
5	Compiere telefonate	56
6	Segreteria telefonica	58
7	Impianti telefonici interni / Servizi addizionali	61
8	Struttura dei menu	62
9	Rubrica telefonica/Elenco chiamate . . .	64
10	Funzioni speciali	65
11	Ampliamento del sistema telefonico . . .	66
12	In presenza di problemi	67
13	Specifiche tecniche	69
14	Consigli per la cura / Garanzia	70
15	Indice alfabetico	71

Indicazioni di sicurezza

1 Indicazioni di sicurezza

Leggere attentamente le presenti istruzioni per l'uso.

Impiego conforme agli usi previsti

Il presente telefono consente di svolgere telefonate all'interno di una rete telefonica. Qualsiasi altro impiego è considerato come non conforme agli usi previsti. Non sono consentite modifiche o trasformazioni non autorizzate. Non aprire per nessuna ragione l'apparecchio autonomamente, né compiere riparazioni di propria iniziativa.

Luogo di installazione

Evitare l'esposizione a fumo, polvere, vibrazioni, sostanze chimiche, umidità, eccessivo calore o irradiazioni solari dirette.

Non utilizzare l'unità portatile in zone esposte al rischio di deflagrazioni.

Alimentatore di rete



Attenzione: Utilizzare solo l'alimentatore a spina fornito in dotazione visto che altri alimentatori di rete potrebbero addirittura danneggiare il telefono. Non ostacolare il libero accesso all'alimentatore a spina con mobili o altri oggetti simili.

Batterie ricaricabili



Attenzione: Non gettare le batterie ricaricabili nel fuoco. Utilizzare solo batterie ricaricabili dello stesso tipo! Osservare la corretta polarità! In caso di inversione della polarità delle batterie ricaricabili, pericolo di esplosione in fase di carica.

Caduta di tensione

In caso di caduta di tensione non è possibile compiere chiamate con il telefono. Si consiglia di ricorrere in caso di emergenza ad un telefono con filo in grado di funzionare anche senza alimentazione elettrica esterna.

Apparecchiature mediche



Attenzione: Non utilizzare il telefono in prossimità di apparecchiature mediche. Non è possibile escludere il subentro di eventuali interferenze.

DECT¹ Telefoni possono causare un fastidioso ronzio in apparecchi acustici.

Smaltimento

Per smaltire il proprio apparecchio, consegnarlo al centro di raccolta comunale incaricato con lo smaltimento conforme (ad es. centro di riciclo materiali). Il simbolo riportato qui a lato indica che non è assolutamente consentito smaltire l'apparecchio assieme ai normali rifiuti domestici! In base a quanto disposto dalla legge sulle apparecchiature elettriche ed elettroniche i proprietari di apparecchi vecchi o usurati sono per legge tenuti a smaltire **apparecchiature elettriche ed elettroniche** attraverso la raccolta differenziata.



Consegnare le batterie ricaricabili per lo smaltimento presso rivenditori al dettaglio di batterie o centri di raccolta che mettono a disposizione appositi contenitori.



Smaltire **confezioni ed imballaggi** in base a quanto indicato dalle norme in vigore a livello locale.

¹ **DECT:** Digital Enhanced Cordless Telecommunication = Standard per telefoni senza cavo.

2 Mettere in funzione il telefono

Indicazioni di sicurezza



Attenzione: Prima della messa in funzione, leggere attentamente le indicazioni di sicurezza riportate al capitolo 1.

Verificare il contenuto della confezione

La confezione comprende:

Contenuto	Modello DET			
	2171	2172 ¹	2173 ¹	2174 ¹
Stazione base (segreteria telefonica) con alimentatore di rete	1	1	1	1
Stazione di carica con alimentatore	-	1	2	3
Unità portatile	1	2	3	4
Cavo di collegamento telefonico	1	1	1	1
Batterie ricaricabili	2	4	6	8
Istruzioni per l'uso	1	1	1	1

¹ Per ulteriori informazioni riguardo la disponibilità di questo set telefonico si prega di visitare il sito www.switel.com.

Collegare la stazione base



Attenzione: Montare la stazione base con una distanza minima di 1 m da altri apparecchi elettronici in modo da evitare interferenze reciproche.

Procedere al collegamento della stazione base seguendo quanto raffigurato nella figura. Utilizzare per motivi di sicurezza solo l'alimentatore di rete oltre al cavo di collegamento telefonico forniti in dotazione.

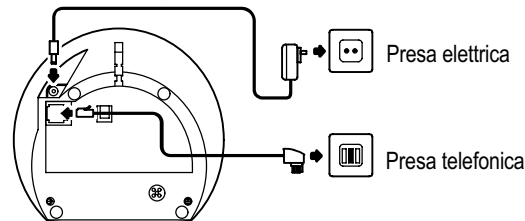

Attenzione: Utilizzare per la stazione base con segreteria telefonica l'alimentatore di rete con le seguenti prestazioni in uscita: 9 V, 500 mA.

Collegare la stazione di carica²

Procedere al collegamento della stazione di carica seguendo quanto raffigurato sul disegno. Per motivi di sicurezza si prega di utilizzare soltanto l'alimentatore di rete fornito in dotazione.

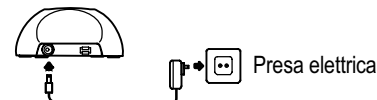

Attenzione: Utilizzare per la stazione di carica l'alimentatore di rete con le seguenti prestazioni in uscita: 6 V, 150 mA.

² Applicabile solo per set telefonici con minimo due unità portatili. Verificare il "Contenuto della confezione" a pagina 51.

Mettere in funzione il telefono

Inserire le batterie ricaricabili

Inserire le batterie ricaricabili nel vano batterie precedentemente aperto. Utilizzare esclusivamente batterie ricaricabili di tipo AAA NiMH da 1,2 V. Osservare la corretta polarità! Chiudere infine il vano accumulatore.

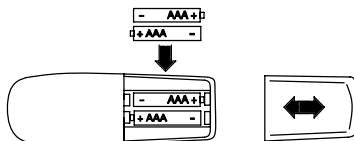

Caricare le batterie ricaricabili

Riporre l'unità portatile in sede di prima messa in funzione per **minimo 14 ore** nella stazione base / stazione di carica.

Non appena il portatile è posizionato correttamente nella stazione base / stazione di carica, si avverte un segnale acustico di avviso. L'unità portatile si surriscalda durante il processo di carica. Questo è un fenomeno normale e non pericoloso. Evitare di caricare l'unità portatile con dispositivi di carica differenti o estranei. Lo **stato di carica attuale delle batterie** è visualizzato sul display:



Carico



A metà



Debole



Scarico

Accettazione di chiamata automatica

L'attivazione di questa funzione consente di ricevere automaticamente una chiamata estraendo semplicemente l'unità portatile dalla stazione base. L'accettazione di chiamata automatica è attivata o disattivata nel menu. A pagina 62 è indicata la posizione da scorrere nel menu.

Impianti telefonici interni

A pagina 61 sono riportate ulteriori informazioni nel caso in cui si volesse collegare il telefono ad un impianto telefonico interno.

Riduzione delle radiazioni (modalità ECO)

Configurazione iniziale = modalità ECO → SPENTO

È possibile impostare il telefono in modo da ridurre l'emissione di radiazioni. ➤ pagina 63.



= ECO MODE → ACCESO.











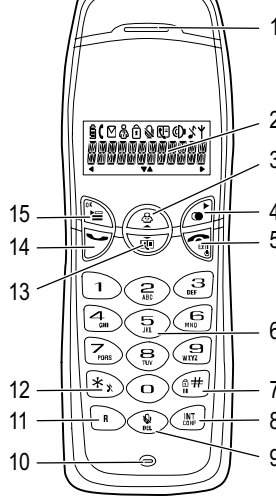

La radiazioni risultano considerevolmente ridotte sia in modalità conversazione che in modalità di stand-by con modalità ECO inserita rispetto ad un telefono cordless a standard DECT.

Se necessario è possibile aumentare la portata del sistema telefonico disattivando la modalità ECO ➤ pagina 63 (ECO MODE → SPENTO).

3 Elementi di comando

I tasti del telefono riportati nel presente manuale d'istruzioni per l'uso sono raffigurati sotto forma di simboli uniformi all'interno di un riquadro. Sono possibili lievi scostamenti dei simboli dei tasti sul telefono rispetto ai simboli qui raffigurati.

Unità portatile

- 
- 1 Altoparlante
 - 2 Display
 - 3 Verso sopra /
Elenco chiamate 
 - 4 Ripetizione di chiamata /
Continua 
 - 5 Tasto di riaggancio /
Tasto di ON/OFF 
 - 6 Tasti numerici
 - 7 Tasto # /
Blocco tastiera 
 - 8 Chiamata interna /
Conferenza 
 - 9 Silenziamento microfono /
Cancellare 
 - 10 Microfono
 - 11 Tasto R (flash) 
 - 12 Tasto * /
Segnalazione di chiamata spenta /
Selezione a toni temporanea 
 - 13 Verso sotto / Rubrica telefonica 
 - 14 Tasto di chiamata 
 - 15 Tasto menu / Conferma 

Stazione base (segreteria telefonica)

- 1 Segreteria telefonica
ON / OFF 
- 2 Cercare unità portatile
(funzione di paging) 
- 3 Regolazione del volume
 
- 4 Riproduzione /
Stop 
- 5 Saltare indietro /
Segnale di avviso 
- 6 Saltare in avanti /
Intercettazione
ON/OFF 
- 7 Microfono
- 8 Cancellare 
- 9 Riprodurre /
registrare annuncio 
- 10 Display
- 11 Registrare promemoria 
- 12 Altoparlante

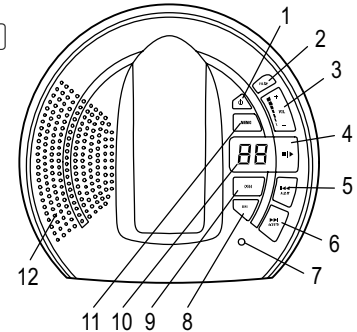

Stazione di carica¹

- 1 Contatti di carica

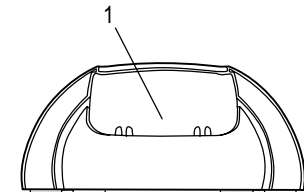













¹ Applicabile solo per set telefonici con minimo due unità portatili
 Verificare il "Contenuto della confezione" a pagina 51.

Informazioni introduttive



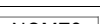

4 Informazioni introduttive













In questo capitolo sono riportate le principali informazioni riguardo l'uso delle presenti istruzioni e del telefono.

Modo di rappresentazione nelle istruzioni per l'uso

Rappresentazione	Descrizione
	Rappresentazione dei tasti
	Premere brevemente il tasto raffigurato
2 sec. 	Premere il tasto raffigurato per 2 secondi
tenere 	Tenere premuto il tasto raffigurato
rilasciare 	Rilasciare il tasto raffigurato
	Immettere cifre o lettere
	Unità portatile squilla
	Stazione base squilla
	Estrarre l'unità portatile dalla stazione base
	Riporre l'unità portatile nella stazione base
	Rappresentazione di testi sul display
	Rappresentazione di simboli sul display

Simboli e testi sul display dell'unità portatile

Simbolo	Descrizione
	Costante: Indicazione dello stato di carica delle batterie. Lampeggiante: Caricare le batterie ricaricabili Segmenti che scorrono: Le batterie sono in fase di ricarica  pagina 52.
	Costante: Chiamata in corso. Lampeggiante: Chiamata in arrivo  pagina 56.

	Costante: Ci si trova nell'elenco chiamate. L'elenco chiamate segnala la presenza di nuove chiamate  pagina 64.
 o 	A sinistra o a destra si trovano altre cifre del numero di chiamata visualizzato.
	La segnalazione acustica di chiamata è spenta  pagina 57.
	Il blocco tastiera è attivato  pagina 57.
	Segreteria telefonica integrata nella rete telefonica. VMWI ¹ - Servizio aggiuntivo del proprio gestore di rete telefonica  pagina 61.
	Il microfono è disattivato  pagina 57.
	Costante: Il collegamento con la stazione base è buono. Lampeggiante: Il collegamento con la stazione base si interrompe. Avvicinarsi alla stazione base.

¹ **VMWI**: Visual Message Waiting Indication = Segnalazione ottica di nuovi messaggi.

Modalità di stand-by

In tutte le descrizioni del presente manuale di istruzioni si considera l'unità portatile in modalità di stand-by. Per passare alla modalità di stand-by, premere il tasto .

Modalità di risparmio energetico

Trascorso un breve intervallo di tempo in modalità di stand-by, l'unità portatile passa in modalità di risparmio energetico. Fatto questo, il display non è più illuminato. Premendo un tasto qualsiasi, l'apparecchio passa in modalità di stand-by.



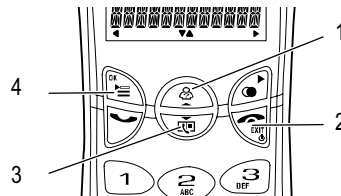









Tasti di navigazione



Tasto	In modalità di stand-by	Nel menu
1	- Aprire l'elenco chiamate	- Scorrere i menu
2	- Attivare/Disattivare l'unità portatile	- Tornare indietro di un livello - Interrompere procedure di programmazione e memorizzazione
3	- Aprire la rubrica telefonica	- Scorrere i menu
4	- Aprire il menu principale	- Aprire il menu / la voce di menu visualizzato/a

Navigazione nel menu









I differenti menu consentono di raggiungere tutte le funzioni del telefono. Il percorso da seguire per giungere alla funzione desiderata è indicato dalla struttura di menu. pagina 62.

	Aprire il menu principale
 o 	Selezionare il sottomenu desiderato
	Aprire il sottomenu
 o 	Selezionare la funzione desiderata
	Aprire la funzione
 o 	Selezionare l'impostazione desiderata
	La tastiera consente di inserire numeri o lettere
	Confermare l'immissione
	Tornare indietro di un livello

 Ogni singolo processo si interrompe automaticamente se entro 30 secondi non si procede con una immissione.

Creare voci nella rubrica telefonica - Esempio

La navigazione nei menu e la procedura da seguire per inserire nuove voci è indicata a titolo esemplificativo in **Creare voci nella rubrica telefonica**. Si consiglia di seguire quanto riportato in questo esempio per tutte le altre impostazioni che si desiderano compiere.

	Aprire il menu
 o 	
RUBRICA , 	Selezionare e confermare funzioni
 o 	
INSERISCI , 	Selezionare e confermare funzioni
	Immettere un nome (max. 12 segni) e confermare
	Immettere un numero telefonico (max. 20 cifre) e confermare

Compiere telefonate

5 Compiere telefonate

Ricevere una chiamata



Ricevere una chiamata

Concludere una chiamata



Concludere una chiamata

Compiere telefonate



Immettere un numero di chiamata (max. 20 cifre)



In caso di immissione errata, cancellare l'ultima cifra



Selezionare un numero di chiamata



È altresì possibile premere il tasto di conversazione e ottenere quindi il segnale di linea libera. Le cifre immesse per la composizione del numero di chiamata desiderato sono immediatamente selezionate. Nel corso di una simile chiamata non è possibile eseguire la correzione di singole cifre che compongono il numero di chiamata.

Ripetizione di chiamata

Il telefono memorizza l'ultimo numero di chiamata selezionato.



Avviare la ripetizione di chiamata e instaurare un collegamento

Richiamare una telefonata ricevuta

Il telefono memorizza 20 chiamate nell'elenco chiamate.



Aprire l'elenco chiamate



Selezionare una voce e instaurare un collegamento

Selezionare numeri di chiamata dalla rubrica telefonica

Per fare questo è necessario aver memorizzato i numeri di chiamata nella rubrica telefonica. pagina 55 e pagina 64.



Aprire la rubrica telefonica



Selezionare una voce e instaurare un collegamento

Compiere una telefonata interna¹

Condurre chiamate interne

Per condurre telefonate interne gratuite bisogna aver registrato due o più unità portatili (UP1, UP2, ...) presso la stazione base.

UP1: , ad es.

Selezionare il numero di chiamata interno dell'unità portatile desiderata

UP2:

Ricevere una chiamata interna con l'altra unità portatile

UP1 / UP2:

Concludere la chiamata interna

Trasferire internamente chiamate esterne

UP1: , ad es.

Selezionare il numero di chiamata interno con telefonata esterna in corso di svolgimento

UP2:

Ricevere una chiamata interna con l'altra unità portatile

UP1:

Trasferire la chiamata







Nel caso in cui l'unità portatile chiamata non rispondesse, la telefonata esterna può essere di nuovo ripresa premendo il tasto



¹ Lo svolgimento di chiamate interne è possibile soltanto in presenza di minimo due unità portatili. Verificare il "Contenuto della confezione" a pagina 51.





Riscontro / Chiamata in attesa

Durante lo svolgimento di una chiamata esterna è possibile chiamare un'altra unità portatile allo scopo di consultarsi o eseguire un riscontro. Mentre è in corso la conversazione con l'interlocutore interno, la chiamata esterna è trattenuta. La procedura può essere ripetuta a piacere.

- UP1:  , ad es.  Selezionare il numero di chiamata interno con telefonata esterna in corso di svolgimento
- UP2:  Ricevere una chiamata interna con l'altra unità portatile
- UP1:  Passare ad un altro interlocutore telefonico

Condurre chiamate a conferenza

Questa funzione consente di condurre una conferenza con una chiamata esterna ed un altro interlocutore interno.

- UP1:  , ad es.  Selezionare il numero di chiamata interno con telefonata esterna in corso di svolgimento
- UP2:  Ricevere una chiamata interna con l'altra unità portatile
- UP1: 2 sec.  Avviare la chiamata in conferenza
- UP1 / UP2:  Concludere la chiamata in conferenza

Impostare il volume del ricevitore

Il volume è regolabile durante lo svolgimento di una chiamata in 3 livelli.

-  o  Selezionare il volume desiderato

Visualizzazione della durata di conversazione

Durante lo svolgimento di una chiamata, la durata della telefonata è visualizzata in minuti e secondi sul display.

Silenziamento del microfono nell'unità portatile

È possibile attivare e disattivare il microfono dell'unità portatile con chiamata telefonica in corso.

-  Disattivare il microfono (silenziamento)
-  Attivare il microfono

Blocco tastiera

Il blocco tastiera impedisce di premere accidentalmente dei tasti.

- 2 sec.  Attivare il blocco tastiera

 L'attivazione del blocco tastiera consente di ricevere telefonate in arrivo come di consueto.

- 2 sec.  Disattivare il blocco tastiera

Melodia di suoneria dell'unità portatile

È possibile disattivare la melodia di suoneria presso l'unità portatile.

- 2 sec.  Disattivare la melodia di suoneria

 Le chiamate sono in tal caso segnalate solo presso la stazione base e non più dall'unità portatile.

- 2 sec.  Attivare la melodia di suoneria

Cercare l'unità portatile (funzione di paging)

Avendo perso d'occhio la propria unità portatile è possibile ritrovarla facilmente grazie all'emissione di un tono di ricerca.

-    Avviare il tono di ricerca
-    Concludere il tono di ricerca

Attivare e disattivare l'unità portatile

Per risparmiare le batterie ricaricabili è possibile spegnere l'unità portatile.

- 2 sec.  Disattivare l'unità portatile
- 2 sec.  Attivare l'unità portatile

Segreteria telefonica

6 Segreteria telefonica

Attivare / Disattivare la segreteria telefonica



Attivare / Disattivare la segreteria telefonica

Durata di registrazione massima

La segreteria telefonica memorizza fino a 60 messaggi. La durata di registrazione massima è di 7 minuti. La lunghezza massima di ogni messaggio è di 2 minuti. Con capacità di memoria esaurita per la registrazione di nuovi messaggi, il dispositivo non registra più nessuna chiamata.

Impostare il volume

Il volume è impostabile in 5 livelli.



Impostare il volume

Impostare il numero di segnalazioni di chiamata (ritardo)

È possibile scegliere tra 2 fino a 7 segnalazioni acustiche di chiamata e l'impostazione **Risparmio di addebiti** ovvero salvagettone per compiere un'interrogazione a distanza senza alcun addebito. Con la funzione di interrogazione a distanza preliminare gratuita è possibile verificare la presenza di nuovi messaggi sulla propria segreteria telefonica.

- Se ci sono messaggi nuovi sulla segreteria telefonica, l'apparecchio accetta la telefonata dopo sole 2 segnalazioni di chiamata.
- Se la chiamata non è accettata dopo 4 squilli, non c'è nessun nuovo messaggio. Riagganciare prima del 4° squillo. In tal modo non risulta alcun addebito.



Quest'impostazione va eseguita presso l'unità portatile
📖 pagina 62!

Per maggiori informazioni sull'interrogazione a distanza 📖 pagina 59.

Segnale di avviso in presenza di messaggi registrati

Nel caso in cui l'apparecchio abbia registrato un nuovo messaggio o promemoria, ogni minuto viene rilasciato un segnale acustico.



Attivare / Disattivare il segnale di avviso

Intercettare chiamate in arrivo

È possibile ascoltare chiamate in arrivo senza bisogno di accettare la chiamata.



Attivare / Disattivare la funzione d'intercettazione

Accettare una chiamata

Qualora la segreteria telefonica avesse già risposto alla telefonata è ciononostante possibile accettare ugualmente la chiamata. La registrazione del messaggio è in tal caso interrotta.



Assumere una chiamata

Registrare / Controllare / Cancellare un annuncio

La segreteria telefonica mette a disposizione due messaggi di annuncio preimpostati. Dopo il messaggio di annuncio 1 è possibile lasciare un messaggio. Il messaggio di annuncio 2 è un messaggio di solo annuncio che non prevede la possibilità di lasciare un messaggio. Il messaggio di annuncio 1 può anche essere sostituito da un messaggio di annuncio individuale. Il messaggio di annuncio 2 non può essere invece modificato. Non appena la memoria della segreteria telefonica è piena, l'apparecchio riproduce automaticamente il messaggio di annuncio 2.

Registrare i messaggi di annuncio

La lunghezza dell'annuncio può essere di massimo 40 secondi.

2 sec. 

Avviare la registrazione



Parlare il messaggio di annuncio e confermare

Verificare l'annuncio attualmente impostato



Riprodurre l'annuncio

Cancellare il proprio messaggio di annuncio e reimpostare l'annuncio standard

Volendo cancellare il proprio annuncio, l'apparecchio riattiva il messaggio d'annuncio preimpostato.



Riprodurre l'annuncio



Cancellare l'annuncio

Registrazione / Controllare / Cancellare un promemoria

Un promemoria è un messaggio che è possibile riprodurre e quindi ascoltare allo stesso modo di un messaggio ricevuto. E' possibile registrare al massimo un promemoria.

Registrazione un promemoria

La lunghezza di un promemoria è di massimo 2 minuti.

2 sec. MEMO	Avviare la registrazione
 	Parlare il promemoria e confermare

Riprodurre il promemoria

MEMO	Riprodurre il promemoria
-------------	--------------------------





Cancellare il promemoria

MEMO	Riprodurre il promemoria
DEL	Cancellare il promemoria

Riprodurre / Cancellare messaggi registrati

Riprodurre messaggi

Avendo precedentemente registrato un promemoria, in caso di ascolto è prima riprodotto il promemoria e quindi i messaggi registrati. I messaggi registrati sono riprodotti nell'ordine in cui sono registrati.

2 sec. 	Riprodurre i messaggi nuovi
	Riprodurre tutti i messaggi
	Interrompere la riproduzione
 ALERT	Ripetere il messaggio
 SCREEN	Messaggio successivo

Cancellare un messaggio

	Riprodurre il messaggio da cancellare
DEL	Cancellare il messaggio

Cancellare tutti i messaggi / promemoria

Sono cancellati tutti i messaggi / tutti i promemoria. Solo messaggi / promemoria nuovi rimangono memorizzati.





















2 sec. DEL	Avviare la procedura di cancellazione
DEL	Cancellare messaggi / promemoria

L'interrogazione a distanza





Chiamando la propria segreteria telefonica è possibile verificare la presenza di messaggi e compiere diverse altre funzioni. Requisito per questa operazione è un telefono abilitato alla selezione a toni.

Codice di sicurezza per l'interrogazione a distanza

Prima di poter compiere l'interrogazione a distanza è necessario immettere un codice di sicurezza. Questo è impostato in fabbrica e corrisponde a "000".

	Quest'impostazione va eseguita presso l'unità portatile!	
		Aprire il menu
 0 	IMPOSTA , 	Selezionare un sottomenu e confermare
 0 	SEGRETERIA , 	Selezionare un sottomenu e confermare
 0 	PIN REMOTO , 	Selezionare e confermare funzioni
 		Immettere il PIN vecchio
 		Immettere il PIN nuovo
 		Ripetere il PIN nuovo

Avviare l'interrogazione a distanza

		Selezionare il proprio numero di chiamata
 		Premere mentre l'annuncio è riprodotto e immettere il codice di sicurezza

 In caso di immissione errata, l'annuncio della segreteria telefonica è nuovamente riprodotto. Con immissione errata del codice di sicurezza per tre volte consecutive il collegamento è interrotto automaticamente.

A questo punto è dato modo di compiere diverse altre funzioni.

 Tabella sulle funzioni dei tasti.

Segreteria telefonica

Attivazione a distanza della segreteria telefonica



Selezionare il proprio numero di chiamata



Avendo dimenticato di inserire la segreteria telefonica, la chiamata è ricevuta solo dopo 10 squilli.



Premere durante la riproduzione dell'annuncio ed immettere il codice PIN



Attivare / Disattivare la segreteria telefonica

A questo punto è dato modo di compiere diverse altre funzioni.



 Tabella sulle funzioni dei tasti.

Funzioni a tasti dell'interrogazione a distanza



L'interrogazione a distanza è interrotta automaticamente se entro 8 secondi non si procede con una immissione.

Le funzioni a tasti dipendono dalla modalità in cui ci si trova. La seguente tabella riassume in una vista panoramica le funzioni abbinata ai singoli tasti.

Tasto	Funzioni	Funzioni da svolgere durante la riproduzione di un messaggio
		Riprodurre il messaggio precedente
	Riprodurre messaggi	Riprodurre nuovamente messaggio in corso
		Riprodurre il messaggio successivo
	Riprodurre promemoria	
	Concludere l'azione	Interrompere il messaggio in corso
	Riprodurre annuncio	
	Registrare un promemoria	
	Attivare / Disattivare la segreteria telefonica	
	Registrare un annuncio	
		Cancellare il messaggio in corso
 , 	Cancellare tutti i messaggi	
	Riagganciando il ricevitore l'interrogazione a distanza è conclusa.	

7 Impianti telefonici interni / Servizi aggiuntivi

Tasto R in impianti telefonici interni

Avendo collegato il telefono ad un impianto telefonico interno, il **tasto R** consente di accedere a tutte le altre funzioni disponibili come per es. trasferimento di chiamata e funzione di richiamata automatica. Si prega di consultare le istruzioni per l'uso del proprio impianto telefonico interno per individuare il tempo flash da impostare al fine di poter usufruire di queste funzioni. Il rivenditore autorizzato è in grado di indicare se il telefono acquistato funzionerà senza alcun problema nel proprio impianto telefonico interno. Il tempo flash è impostato nel menu. A pagina 62 è indicata la posizione da scorrere nel menu.

Pausa di selezione

In presenza di impianti telefonici interni è necessario preselezionare un numero di accesso alla rete esterna per ottenere un segnale di linea libera prima di poter compiere una telefonata. Alcuni impianti telefonici interni di vecchia data richiedono un po' di tempo prima di trasmettere il segnale di libero. Per questi impianti telefonici interni è possibile inserire una pausa di selezione dopo il numero di accesso alla linea esterna in modo da poter proseguire con la selezione del numero senza dover attendere il segnale di libero.

2 sec. 

Inserire una pausa di selezione

Dopo il numero di accesso alla rete esterna si procede, trascorso un determinato intervallo di tempo, con la selezione del numero di chiamata vero e proprio.



La pausa di selezione è memorizzabile anche in sede di immissione di numeri di chiamata nella rubrica telefonica.

Tasto R e servizi aggiuntivi

Il telefono supporta servizi aggiuntivi messi a disposizione dal proprio gestore di rete telefonica come per es. le funzioni di chiamata in attesa, avviso di chiamata e chiamata a conferenza. Il **tasto R** consente di accedere a questi servizi aggiuntivi. Si prega di consultare il proprio gestore di rete telefonica per ottenere informazioni sul tempo flash necessario all'utilizzo dei servizi aggiuntivi. Rivolgersi al proprio gestore di rete telefonica per ottenere l'abilitazione ai servizi aggiuntivi. Il tempo flash è impostato nel menu. A pagina 62 è indicata la posizione da scorrere nel menu.

Visualizzazione del numero di chiamata (CLIP¹)



La visualizzazione del numero di chiamata è un servizio aggiuntivo offerto dal proprio gestore di rete telefonica. Si consiglia di rivolgersi al proprio gestore di rete telefonica per ricevere maggiori informazioni a riguardo.

A condizione che il collegamento telefonico disponga di questa funzione, l'apparecchio visualizza il numero telefonico del chiamante non appena il telefono squilla. Nel caso in cui il chiamante abbia soppresso la trasmissione del proprio numero di chiamata, appare un'apposita indicazione. Se il numero di chiamata non è visualizzabile, questo non sarà memorizzato nell'elenco chiamate.

Segreteria telefonica integrata nella rete telefonica

Sono numerosi i gestori di rete telefonica che offrono come servizio aggiuntivo una segreteria telefonica integrata nella stessa rete. Se il proprio gestore di rete telefonica mette a disposizione una segreteria telefonica all'interno della propria rete telefonica, un simbolo informa sulla presenza di nuovi messaggi (VMWI²). Questa funzione è disponibile solo nel caso di abilitazione al servizio da parte del gestore di rete telefonica. Per maggiori dettagli a riguardo, rivolgersi al proprio gestore di rete telefonica.





¹ **CLIP**: Calling Line Identification Presentation = Visualizzazione del numero telefonico del chiamante.



² **VMWI**: Visual Message Waiting Indication = Segnalazione ottica di nuovi messaggi.

Struttura dei menu

8 Struttura dei menu

Menu principale

Per passare al menu principale, premere il tasto . Selezionare quindi una voce con il tasto  /  e confermare la scelta con il tasto .

RUBRICA	INSERISCI	NOME?	NUMERO?
	MODIFICA		
	CANCELLA	 / 	CONFERMA?
	CANC TUTTO	CONFERMA?	
DISPLAY	NOME PORT		
	ILLUMINAZ	ACCESO	SPENTO
	LINGUA	ITALIANO, DEUTSCH, FRANCAIS, ENGLISH	
SUONI	SUONERIA HS	MELODIA	MELODIA 1-10
		VOLUME	SPENTO, 1-5
	BASE	MELODIA	MELODIA 1-10
		VOLUME	SPENTO, 1-5
	TONI TASTI	ACCESO	SPENTO
	TONI PORTAT	ACCESO	SPENTO
IMPOSTA	SEGRETERIA	RITARDO RISP	1-7, SALVAGETTONE
		PIN REMOTO	NUOVO PIN RIPETI PIN
	RISP AUTOM	ACCESO	SPENTO
	MODO SELEZ	MULTIFREQ	DECADICA
	R/FLASH	R/FLASH 1-2	(100 ms / 300 ms)





SISTEMA

REGISTRA	PIN (0000)	1 2 3 4	CERCA BASE
SELEZ BASE	BASE AUTO	BASE 1-4	
CANC PORTAT	PORTATILE 1-4	PIN	
PIN	PIN	NUOVO PIN	RIPETI PIN
ECO MODE	ACCESO	SPENTO	
RESET	PIN		

Rubrica telefonica

9 Rubrica telefonica/Elenco chiamate

Rubrica telefonica

Nella rubrica telefonica è possibile memorizzare 20 numeri di chiamata con rispettivi nomi.

- Assegnare a tutti i numeri di chiamata sempre un prefisso in modo da poter riconoscere anche una chiamata urbana in arrivo ed abbinarla ad una voce presente nella rubrica telefonica.
- Con capacità di memoria esaurita, il display visualizza una rispettiva indicazione. Per poter disporre di nuovo spazio memoria, cancellare prima una voce già presente.
- Le voci della rubrica telefonica sono elencate in ordine alfabetico. Per accedere direttamente alla voce della rubrica telefonica desiderata, premere la lettera iniziale corrispondente.

Immettere nomi

I tasti numerici riportano altresì delle lettere. Premendo ripetutamente il relativo tasto si ha modo di selezionare lettere e cifre.

	Immettere spazi vuoti
	Cancellare



Avendo precedentemente immesso nella rubrica telefonica il nome corrispondente, appare l'indicazione NOME. Modificare il nome.



Per immettere la stessa lettera una seconda volta, premere la rispettiva lettera. Attendere fino a quando il cursore si sia spostato di una posizione. Immettere quindi la lettera una seconda volta.

Elenco chiamate

All'interno dell'elenco chiamate è possibile memorizzare in tutto 20 numeri telefonici.



La visualizzazione del numero di chiamata (**CLIP**¹) è un servizio aggiuntivo del proprio gestore di rete telefonica. Nel caso in cui il gestore della rete telefonica supporti il servizio, sul display del telefono è visualizzato il numero di chiamata. Per maggiori dettagli a riguardo, rivolgersi al proprio gestore di rete telefonica.

¹ **CLIP**: Calling Line Identification Presentation = Visualizzazione del numero telefonico del chiamante.

Visualizzare numeri di chiamata dall'elenco chiamate



Aprire l'elenco chiamate e selezionare una voce

Selezionare un numero di chiamata dall'elenco chiamate e salvarlo nella rubrica telefonica

È possibile memorizzare un numero di chiamata direttamente dall'elenco chiamate nella rubrica telefonica.

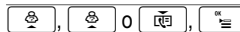

Aprire l'elenco chiamate e selezionare una voce



Avviare la procedura di memorizzazione



Immettere un nome e confermare



Aggiornare se necessario il numero e confermare



Non appena al numero di chiamata nella rubrica telefonica è assegnato un nome, nell'elenco chiamate è visualizzato il nome inserito.

Cancellare numeri di chiamata dall'elenco chiamate

Cancellare singoli numeri di chiamata

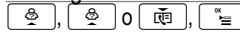

Aprire l'elenco chiamate e selezionare una voce

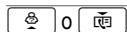

Attivare la procedura di cancellazione

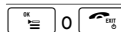

Confermare la procedura di cancellazione o interrompere

Cancellare tutti i numeri di chiamata



Aprire l'elenco chiamate

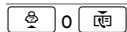

Attivare la procedura di cancellazione

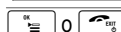

Confermare la procedura di cancellazione o interrompere

10 Funzioni speciali

Procedura di selezione

Il telefono può essere impiegato nell'ambito di impianti telefonici interni sia analogici (procedura di selezione a impulsi) che digitali (procedura di selezione a toni). La procedura di selezione è impostata nel menu. A pagina 62 è indicata la posizione da scorrere nel menu.

Selezione a toni temporanea

Qualora fosse possibile utilizzare il telefono soltanto con la procedura di selezione a impulsi, non sarà necessario rinunciare ai vantaggi della procedura di selezione a toni (per es. interrogazione della segreteria telefonica dalla rete telefonica). Con chiamata in corso è possibile passare temporaneamente alla procedura di selezione a toni.

1 sec. Premere con chiamata in corso

Alla fine della telefonata, l'apparecchio passa di nuovo automaticamente alla procedura di selezione a impulsi.

Ampliamento del sistema telefonico

11 Ampliamento del sistema telefonico

Lo standard internazionale **GAP**¹ regola la compatibilità di unità portatili e stazioni base di costruttori differenti. In tal modo è possibile adoperare apparecchi SWITEL in combinazione con apparecchi di altri costruttori all'interno di un unico sistema telefonico. Può comunque anche verificarsi la mancata disponibilità di alcune funzioni.

Maggior numero di unità portatili

È possibile registrare complessivamente 4 unità portatili alla propria stazione base.

Registrare unità portatili

Prima di procedere alla registrazione di un'unità portatile, passare con la stazione base alla modalità di registrazione.

4 sec. **PAGE** / , Avviare la modalità di registrazione

Registrare quindi l'unità portatile  pagina 63. Utilizzare per la registrazione il codice PIN attualmente impostato  pagina 63.

Una volta eseguita la selezione, all'unità portatile è assegnato un numero di chiamata interno. Questo numero di chiamata interno è visualizzato sul display.

 Per registrare unità portatili di altri costruttori, leggere prima le rispettive istruzioni per l'uso.

Deregistrare unità portatili

 Per compiere la deregistrazione di un'unità portatile da una stazione base è necessario servirsi di un'unità portatile registrata a sua volta presso la stessa stazione base.

Unità portatili sono deregistrate nel menu. A pagina 63 è indicata la posizione da scorrere nel menu.



Maggior numero di stazioni base

La portata della propria unità portatile può essere aumentata registrando l'apparecchio ad un numero maggiore di stazioni base. È possibile registrarsi contemporaneamente presso 4 stazioni base differenti. Ogni stazione base necessita di una propria presa telefonica. Si può trattare di allacciamenti con lo stesso o differente numero di chiamata.

 Per chiamate in corso non è invece possibile compiere un trasferimento da una stazione base all'altra.

Aumento della portata

Posizionare le stazioni base in modo da ottenere un'intersecazione della portata delle singole stazioni base. Verificare la portata delle unità portatili considerato che edifici possono limitare la portata. Registrare quindi l'unità portatile presso tutte le stazioni base. Attivare la funzione **selezione automatica** della stazione base  pagina 63. L'unità portatile individua automaticamente la stazione base più vicina con la migliore portata.

 Se necessario è possibile aumentare la portata del sistema telefonico disattivando la modalità ECO  pagina 63 (ECO MODE → SPENTO).

Maggiore mobilità grazie a punti di ubicazione differenti

Registrare l'unità portatile a unità base presenti in punti di ubicazione differenti. Attivare la funzione **selezione automatica** della stazione base  pagina 63. Indipendentemente dal luogo in cui ci si trova, l'unità portatile cercherà sempre automaticamente la stazione base più vicina con la portata migliore.

¹ **GAP**: Generic Access Profile = Standard per l'interazione di unità portatili e stazioni base di altri costruttori differenti.

12 In presenza di problemi

Hotline di assistenza

In presenza di problemi con il telefono, seguire le indicazioni riportate qui di seguito. In caso di problemi tecnici è possibile rivolgersi alla nostra hotline di assistenza tecnica chiamando al numero 0900 00 1675 valido per la Svizzera (spese da rete Swisscom alla data di stampa: CHF 2.00 / min). In caso di reclami entro il periodo di garanzia, rivolgersi al rivenditore autorizzato. Il periodo di garanzia ricopre 2 anni.

Domande e risposte

Domande	Risposte
Non è possibile instaurare un collegamento con la stazione base	<ul style="list-style-type: none"> - Verificare se la registrazione alla stazione base è stata eseguita con il codice PIN corretto ☞ pagina 63.
Non è possibile condurre una chiamata telefonica.	<ul style="list-style-type: none"> - Il telefono non è collegato correttamente oppure presenta un guasto. Utilizzare esclusivamente il cavo di collegamento telefonico fornito. - Provare con un altro telefono se l'allacciamento telefonico in questione è funzionante. - L'alimentatore di rete non è inserito oppure si è in presenza di una caduta di tensione totale. - Le batterie ricaricabili sono scariche o difettose. - La distanza dalla stazione base è troppo grande. - La procedura di selezione è stata impostata in modo errato ☞ pagina 62.

Collegamento disturbato, interrotto	<ul style="list-style-type: none"> - La distanza dalla stazione base è troppo grande. - Luogo di installazione della stazione base errato.
Il sistema non reagisce più.	<ul style="list-style-type: none"> - Ripristinare la configurazione iniziale per tutte le funzioni ☞ pagina 63. - Estrarre brevemente l'alimentatore di rete dalla presa di corrente.
Le batterie ricaricabili si scaricano piuttosto subito.	<ul style="list-style-type: none"> - Le batterie sono scariche o difettose. - Riporre l'unità portatile correttamente nella stazione base. Pulire le superfici di contatto su unità portatile e stazione base con un panno morbido e asciutto. - Posizionare l'unità portatile per la durata di 14 ore nella stazione base.
La visualizzazione del numero di chiamata (CLIP ¹) non funziona	<ul style="list-style-type: none"> - La visualizzazione del numero di chiamata è un servizio addizionale offerto dal proprio gestore di rete telefonica. Per maggiori dettagli a riguardo, rivolgersi al proprio gestore di rete telefonica. - Il chiamante ha disattivato la trasmissione del proprio numero di chiamata.

¹ **CLIP:** Calling Line Identification Presentation = Visualizzazione del numero telefonico del chiamante.

In presenza di problemi

La segreteria telefonica non registra alcun messaggio

- Assicurarsi che la segreteria telefonica sia stata collegata e inserita correttamente.
- Verificare se la memoria della segreteria telefonica è piena. Cancellare se necessario messaggi dalla memoria ☞ pagina 59.

Non è possibile registrare nessun promemoria

- Verificare se è stato già registrato un promemoria. Cancellare se necessario il promemoria vecchio ☞ pagina 59.
- Verificare se la memoria della segreteria telefonica è piena. Cancellare se necessario messaggi dalla memoria ☞ pagina 59.

Non è possibile compiere l'interrogazione a distanza

- Verificare se si utilizza il codice di sicurezza corretto per l'interrogazione a distanza ☞ pagina 59.
- Il telefono utilizzato per compiere l'interrogazione a distanza deve passare alla procedura di selezione a toni.

13 Specifiche tecniche

Specifiche tecniche

Caratteristica	Valore
Standard	DECT¹-GAP²
Alimentazione elettrica (stazione base) con segreteria telefonica	Ingresso: 220/230 V, 50 Hz Uscita: 9 V, 500 mA
Alimentazione elettrica (stazione di carica)	Ingresso: 220/230 V, 50 Hz Uscita: 6 V, 150 mA
Portata	Esterno: ca. 300 m Interno: ca. 50 m
Stand-by	fino a 120 ore
Max. durata di conversazione	fino a 12 ore
Batterie ricaricabili	2 x AAA NiMH 1,2 V
Procedura di selezione	Procedura di selezione a toni Procedura di selezione a impulsi
Temperatura ambiente ammessa	da 10 °C a 30 °C
Umidità dell'aria relativa ammessa	da 20 % a 75 %
Funzione flash	100 ms, 300 ms

¹ **DECT**: Digital Enhanced Cordless Telecommunication = Standard per telefoni senza cavo.

² **GAP**: Generic Access Profile = Standard per l'interazione di unità portatili e stazioni base di altri costruttori differenti.

Configurazione iniziale

La configurazione iniziale è ripristinata nel menu. A pagina 63 è indicata la posizione da scorrere nel menu.

Unità portatile

Lingua	ITALIANO
Accettazione di chiamata automatica	ACCESO
Procedura di selezione	MULTIFREQ
Melodia	1
Volume di squillo	3
Suono tasti	ACCESO
Volume del ricevitore	2
modalità ECO (ECO MODE)	SPENTO

Stazione base

Codice PIN	0000
------------	------

Segreteria telefonica

Codice di sicurezza per l'interrogazione a distanza	000
---	-----

Dichiarazione di conformità

Questo apparecchio risponde a quanto disposto dalla Direttiva UE:

1999/5/CE Direttiva concernente le apparecchiature radio, le apparecchiature terminali di telecomunicazioni e il reciproco riconoscimento della loro conformità. La conformità con la direttiva di cui sopra viene confermata dal marchio CE applicato sull'apparecchio.



Per la dichiarazione di conformità completa si prega di voler usufruire del servizio gratuito di download dal nostro sito Internet www.switel.com.

Consigli per la cura / Garanzia

14 Consigli per la cura / Garanzia

Consigli per la cura

- Pulire le superfici degli apparecchi con un panno morbido e antipilling.
- Non utilizzare mai detergenti o solventi.

Garanzia

Gli apparecchi SWITEL sono costruiti e collaudati in osservanza dei processi di produzione più moderni. L'impiego di materiali selezionati e tecnologie altamente sviluppate sono garanti di una perfetta funzionalità e lunga durata in vita. La garanzia non viene considerata esecutiva qualora la causa del malfunzionamento dell'apparecchio sia riconducibile al gestore della rete telefonica oppure se questa è da attribuirsi ad un impianto telefonico interno interposto. La garanzia non si estende a batterie, accumulatori o batterie ricaricabili utilizzati all'interno degli apparecchi. Il periodo di garanzia ricopre 24 mesi a partire dalla data di acquisto.

Entro il periodo di garanzia si procederà all'eliminazione gratuita di tutti i guasti dovuti a difetti di materiale o produzione. Il diritto di garanzia cessa in caso di interventi da parte dell'acquirente o di terzi. Danni derivanti da un impiego o esercizio non conforme agli usi previsti, a naturale usura, a errato montaggio o errata conservazione, a collegamento o installazione impropri, dovuti a forza maggiore o ad altri influssi esterni non sono coperti da garanzia. In qualità di costruttore ci riserviamo il diritto, in caso di reclami, di riparare o sostituire le parti difettose o di rimpiazzare l'apparecchio. Parti o apparecchi sostituiti passano di nostra proprietà. Sono esclusi diritti di risarcimento per danni qualora non siano dovuti a intenzione o colpa grave del costruttore.

Nel caso in cui il presente apparecchio dovesse ciò nonostante presentare un difetto durante il periodo di garanzia, si prega di rivolgersi esclusivamente al negozio di rivendita dell'apparecchio SWITEL assieme al relativo scontrino di acquisto. In base alle presenti disposizioni, tutti i diritti di garanzia dovranno essere fatti valere esclusivamente nei confronti del rivenditore autorizzato. Decorso il termine di due anni dalla data di acquisto e consegna dei nostri prodotti non sarà più possibile fare valere alcun diritto di garanzia.

15 Indice alfabetico

A

Accettare una chiamata, 58
 Accettazione di chiamata, 52, 56
 Agganciare il ricevitore, 56
 Ampliamento, 66
 Annunci, 58
 Attivare, 57, 58
 Attivazione a distanza, 60

B

Blocco tastiera, 57

C

Cancellare, 58, 59, 64
 Caricare, 52
 Cercare, 57
 Chiamata in attesa, 57
 Chiamate a conferenza, 57
 Chiamate interne, 56
 CLIP, 61
 Codice di sicurezza, 59
 Compiere telefonate, 56
 Concludere una chiamata, 56
 Configurazione iniziale, 69
 Consigli per la cura, 70
 Contenuto della confezione, 51
 Controllare, 58, 59
 Creare, 55

D

Deregistrare, 66
 Dichiarazione di conformità, 69
 Disattivare, 57, 58
 Display, 54
 Domande e risposte, 67
 Durata di conversazione, 57
 Durata di registrazione, 58

E

Elementi di comando, 53
 Elenco chiamate, 64
 Eliminare guasti, 67
 Esercizio, 54

F

Funzione di richiamata, 56
 Funzioni, 65
 Funzioni a tasti, 60

G

Garanzia, 70

H

Hotline di assistenza, 67

I

Immissione di un nome, 64
 Immissione di un testo, 64
 Impianti telefonici interni, 52, 61
 Indicazioni di sicurezza, 50
 Inserire le batterie ricaricabili, 52
 Intercettare, 58
 Interrogazione a distanza, 59

M

Melodia di suoneria, 57
 Menu principale, 62
 Messa in funzione, 51
 Messaggi, 59
 Modalità di risparmio energetico, 55
 Modalità di stand-by, 55
 Modalità ECO, 52
 Modi di scrittura, 54

N

Numero di segnalazioni di chiamata, 58

P

Paging, 57
 Pausa di selezione, 61
 Portata, 66
 Problemi, 67
 Procedura di selezione, 65
 Procedura di selezione a impulsi, 65
 Procedura di selezione a toni, 65
 Promemoria, 59

R

Registrare, 58, 59, 66
 Riduzione delle radiazioni, 52
 Ripetizione di chiamata, 56
 Riprodurre, 59
 Riscontro, 57
 Ritardo, 58
 Rubrica telefonica, 56, 64

S

Salvare, 55, 64
 Segnale di avviso, 58
 Segreteria telefonica, 58
 Segreteria telefonica integrata nella rete telefonica, 61
 Selezionare, 56
 Selezione a toni temporanea, 65
 Servizi aggiuntivi, 61

Silenziamento, 57
 Silenziamento del microfono, 57
 Simboli, 54
 Simboli di display, 54
 Sollevare il ricevitore, 56
 Specifiche tecniche, 69
 Spese telefoniche, 58
 Stato di carica delle batterie ricaricabili, 52
 Stazione base, 51, 53, 66
 Stazione di carica, 51
 Struttura dei menu, 62

T

Tasti di navigazione, 55
 Tasto R, 61
 Trasferimento di chiamata, 56

U

Unità portatile, 66

V

Visualizzazione del numero di chiamata, 61, 64
 VMWI, 61
 Voci della rubrica telefonica, 55
 Volume, 58
 Volume del ricevitore, 57

Contents

1	Safety Information	73
2	Putting the Telephone into Operation . . .	74
3	Operating Elements	76
4	Preliminary Information	77
5	Telephoning	79
6	Answering Machine	81
7	PABX / Supplementary Services	84
8	Menu Structure	85
9	Phone Book / Call Log	87
10	Special Functions	88
11	Extending the Telephone System	89
12	In Case of Problems	90
13	Technical Properties	92
14	Maintenance / Guarantee	93
15	Index	94

1 Safety Information

Please read this operating instruction manual thoroughly.

Intended use

The telephone is suitable for telephoning within a public telephone network system. Any other use is considered unintended use. Unauthorised modification or reconstruction is not permitted. Under no circumstances open the device or complete any repair work yourself.

Installation location

Prevent excessive exposure to smoke, dust, vibration, chemicals, moisture, heat and direct sunlight.

Do not use the handset in potentially explosive areas.

Power adapter plug



Attention: Only use the power adapter plug supplied because other power supplies could damage the telephone. Ensure access to the power adapter plug is not obstructed by furniture or such.

Rechargeable batteries



Attention: Never throw batteries into a fire. Only use batteries of the same type. Pay attention the correct polarity. Incorrect polarity of the batteries represents a risk of explosion during charging.

Power failure

The telephone cannot be used to make calls in the event of a power failure. Always keep a cord connected telephone which operates without an external power supply available in case of emergency situations.

Medical equipment



Attention: Never use the telephone in the vicinity of medical equipment. Effects on such equipment cannot be fully ruled out.

DECT¹ telephones can cause an unpleasant humming sound in hearing aids.

¹ DECT: Digital Enhanced Cordless Telecommunication = Standard for cordless telephones.

Disposal

In order to dispose of your device, take it to a collection point provided by your local public waste authorities (e.g. recycling centre). The adjacent symbol indicates that the device must not be disposed of in normal domestic waste! According to laws on the disposal of electronic and electrical devices, owners are obliged to dispose of old **electronic and electrical devices** in a separate waste container.



Batteries must be disposed of at the point of sale or at the appropriate collection points provided by the public waste authorities.



Packaging materials must be disposed of according to local regulations.

Putting the Telephone into Operation

2 Putting the Telephone into Operation

Safety information



Attention: It is essential to read the Safety Information in Chapter 1 before starting up.

Checking the package contents

The package contains:

Contents	DET Model			
	2171	2172 ¹	2173 ¹	2174 ¹
Base station (answering machine) with power adapter plug	1	1	1	1
Charging station with power adapter plug	-	1	2	3
Handset	1	2	3	4
Telephone connection cable	1	1	1	1
Batteries	2	4	6	8
Operating instructions	1	1	1	1

Connecting the base station



Attention: Position the base station at least 1 m away from other electronic devices, otherwise there is a risk of mutual disturbance.

Connect the base station as illustrated in the diagram. For reasons of safety, only use the power adapter plug and telephone connection line supplied.

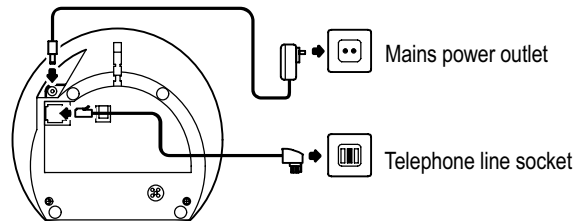

Attention: With regard to the base station with answering machine, use the power adapter plug bearing the output data: 9 V, 500 mA.

Connecting the charging station ²

Connect the charging station as illustrated in the diagram. For safety reasons, only use the power adapter plug supplied.

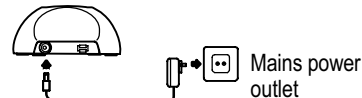

Attention: With regard to the charging station, use the power adapter plug bearing the output data: 6 V, 150 mA.

¹ Visit www.switel.com to find out whether the telephone set is already available.

² Only applies to telephone sets with at least two handsets;  "Checking the package contents" on Page 74.

Inserting the batteries

Insert the batteries in the open battery compartment. Only use batteries of the type AAA NiMH 1.2 V. Pay attention to correct polarity. Close the battery compartment cover.

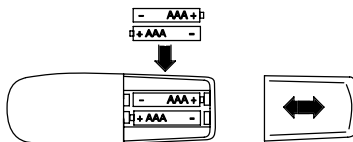

Charging the batteries

Before the handset is used for the first time, insert it in the base station / charging station for **at least 14 hours**.

When the handset is properly inserted in the base station / charging station, you will hear an acoustic signal. The handset warms up during the charging process. This is normal and does not represent a risk. Do not charge the handset with charging units from other manufacturers. The current **battery charge status** is indicated in the display:



Full



Half empty



Low



Empty

Automatic answering

If this function is activated, an incoming call is taken when the handset is removed from the base station. The AUTO ANSWER function is activated and deactivated using the menu. Refer to Page 85 for the sequence of menu option selections.

Private branch exchanges

The information on Page 84 explains how to install your telephone in a private branch exchange.

Low radiation operation (ECO mode)

Default settings = ECO-MODE → OFF

The telephone can be set up so that the radiation frequency is reduced; Page 86.



= ECO MODE → ON.

Both in Call mode as well as in Standby mode, the radiation is reduced considerably when ECO mode is activated as compared to standard, cordless DECT telephones.











If necessary, you can increase the range of the telephone system by switching ECO MODE off Page 86 (ECO MODE → OFF).

Operating Elements

3 Operating Elements







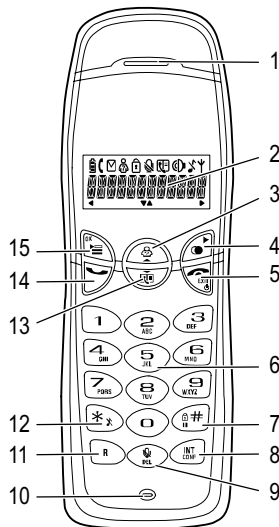



The buttons in this operating manual are subsequently depicted with a uniform contour. Therefore, slight deviations in the appearance of the symbols on the telephone buttons compared to those depicted here are possible.

Handset

- 1 Earpiece
- 2 Display
- 3 Scroll up / Call log 
- 4 Redialling / Continue 
- 5 On-hook key / On/Off switch 
- 6 Digit keys
- 7 # button / Key lock 
- 8 Internal call / Conference call 
- 9 Muting function / Delete 
- 10 Microphone
- 11 R-button (Flash) 
- 12 * button / Switch ringing tone off / Temporary tone dialling mode 
- 13 Scroll down / Phone book 
- 14 Call button 
- 15 Menu button / Confirmation 



Base station (answering machine)

- 1 Answering machine on / off 
- 2 Locate handset (Paging) 
- 3 Volume control 
- 4 Play / Stop 
- 5 Skip back / Alert signal  
- 6 Skip forward / Call screening on / off  
- 7 Microphone
- 8 Delete 
- 9 Play / Record outgoing message (OGM) 
- 10 Display
- 11 Record memo 
- 12 Loudspeaker

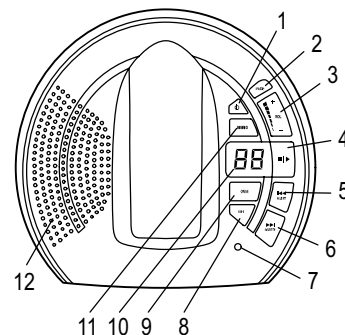

Charging station¹

- 1 Charge contacts

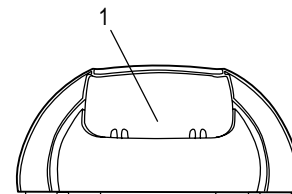













¹ Only applies to telephone sets with at least two handsets
 "Check package contents" on Page 74.







4 Preliminary Information











This chapter provides basic information on using the operating instruction manual and the telephone.

Display and notation of operating sequences

Display	Description
	Displays the contour of buttons
	Press the button depicted briefly
2 sec 	Press the button depicted for 2 seconds
Hold 	Press and hold down the button depicted
Release 	Release the button depicted
	Enter digits or letters
	Handset rings
	Base station rings
	Remove the handset from the base station
	Place the handset in the base station
	Depicts text in the display
	Depicts icons in the display

Icons and texts in the handset display

Icon	Description
	On: Battery charge capacity indicator. Flashing: The batteries must be charged. Run-through segments: The batteries are being charged;  Page 75.
	On: A call is currently being made. Flashing: A call has been received;  Page 79.
	On: The call log is open. There are new calls in the call log;  Page 87.

 or 	There are more digits to the left or right of the phone number displayed.
	The ringing tone has been switched off;  Page 80.
	The key lock is activated;  Page 80.
	There is an answering machine provided in the telephone network. VMWI ¹ - Supplementary service offered by telephone network providers;  Page 84.
	The microphone has been muted;  Page 80.
	On: The connection to the base station is good. Flashing: The connection to the base station is interrupted. Move nearer to the base station.

¹ **VMWI**: Visual Message Waiting Indication = Visual indicator that new messages have been recorded.

Preliminary Information

Standby mode

All descriptions in this operating manual assume that the handset is in Standby mode. The system switches to Standby mode by pressing the  button.

Energy-save mode

When the handset has been in Standby mode for some time, it automatically switches to energy-save mode. The display no longer lights up. Press any button to reactivate Standby mode.

Navigation buttons

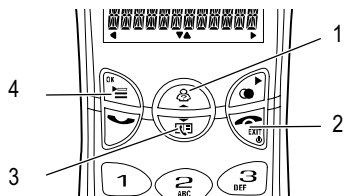













Button	In Standby mode	In a menu
1	- Open the call log	- Scroll through the menu
2	- Switch handset on/off	- Move one level back - Cancel the programming and saving processes
3	- Open the phone book	- Scroll through the menu
4	- Open the main menu	- Open the menu/menu option displayed

Navigating in the menu

All the functions can be accessed via the various menus. Refer to the menu structure to find how to access the respective functions;











 Page 85.

	Open the main menu
 or 	Select the submenu required
	Open the submenu
 or 	Select the function required
	Open the function
 or 	Select the setting required
	Enter digits or letters using the relevant digit keys
	Confirm the input
	Move one level back

 Every process is automatically cancelled if there is no input within 30 seconds.

Creating phone book entries - example

The way in which to navigate through the menus and enter data is explained by means of the example **Creating phone book entries**. Proceed as in this example for all the settings.

	Open the menu
 or 	
PHONEBOOK, 	Select the function and confirm
 or 	
ADD RECORD, 	Select the function and confirm
 , 	Enter the name (max. 12 characters) and confirm it
 , 	Enter the phone number (max. 20 digits) and confirm it

5 Telephoning

Taking a call

or Take the call

Ending a call

or End the call

Making a call

Enter the phone number (max. 20 digits)

Delete the last digit if incorrect

Dial the phone number

It is also possible to press the Call button first to obtain the dialling tone for an outside line. The digits then entered are dialled immediately. It is not possible to correct wrong digits individually using this dialling procedure.

Redialling

Your telephone stores the last phone number dialled.

Activate redialling and dial the number

Calling back calls received

The telephone stores the numbers of the last 20 calls received in a call log.

Open the call log

or , Select the entry and dial the number

Dialling numbers from the phone book

There must be phone numbers stored in the phone book;

Page 78 and Page 87.

Open the phone book

or , Select the entry and dial the number

Internal calls¹

Making an internal call

There must be two or more handsets (HS1, HS2, ...) registered on your base station in order to make internal calls free of charge.

HS1: , e.g. Dial the internal call number of the handset required

HS2: Take the internal call on the other handset

HS1 / HS2: End the internal call

Transferring external calls internally

HS1: , e.g. Dial the internal call number of the handset required during the external call

HS2: Take the internal call on the other handset

HS1: Transfer the call



If the handset called does not answer, take the external call back by pressing the button.

¹ It is only possible to make internal calls when at least two handsets are connected; "Checking the package contents" on Page 74.

Telephoning

Holding a call / brokering

While a call is in progress, it is possible to dial another handset in order to consult with someone. The external caller is put on hold while you converse with the second, internal person called. You can repeat this procedure as often as required.



HS1: , e.g.  Dial the internal call number of the handset required during the external call

HS2:  Take the internal call on the other handset

HS1:  Switch between callers

Conference calls

An external call can be transferred to another internal handset for a conference call.

HS1: , e.g.  Dial the internal call number of the handset required during the external call

HS2:  Take the internal call on the other handset

HS1: 2 sec  Start the conference function

HS1 / HS2:  End the conference

Setting the receiver volume

The volume can be adjusted to one of 3 settings during a call.

 or  Select the volume required

Talk time display

The duration of a call is displayed in minutes and seconds during the call.

Muting the microphone in the handset

The microphone in the handset can be activated and deactivated during a telephone conversation.

 Deactivate the microphone (muting function on)

 Activate the microphone

Key lock

The key lock prevents functions assigned to buttons being activated inadvertently.

2 sec  Activate the key lock function

 Incoming calls can still be taken in the normal way even when the key lock function is activated.

2 sec  Deactivate the key lock function

Handset ringing melody

The ringing melody on the handset can be deactivated.

2 sec  Deactivate the ringing melody

 Only the base station rings in the event of an incoming call, not the handset.

2 sec  Activate the ringing melody

Searching for the handset (Paging)

If you have mislaid your handset, you can locate it again with the aid of a search tone.

   Start the search tone

  or  Stop the search tone

Switching the handset off and on

You can switch the handset off to save the batteries.

2 sec  Switch the handset off

2 sec  Switch the handset on

6 Answering Machine

Switching the answering machine on/off



Switch the telephone answering machine on/off

Maximum recording time

The answering machine can store up to 60 messages. The maximum recording time is 7 minutes. The maximum length of a message is 2 minutes. When the memory capacity for new messages is exhausted, no further messages are recorded.

Setting the volume

The volume can be set to one of 5 different levels.

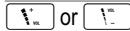

Set the volume required

Setting the number of rings (answering delay)

You can select from 2 to 7 ringing tones or the **TollSaver** setting for pre-remote access free of charge. The free pre-remote access function enables you to determine whether new messages have been left on your answering machine.

- If new message have been recorded on your answering machine, your call is taken after 2 rings.
- If no new messages have been recorded, the call is taken after 4 rings. End the call before the 4th ring. This means that no charges ensue.



These settings are completed on the handset Page 85!

For further information on remote access, refer to Page 82.

Alert signal for recorded messages

An alert signal is issued at one minute intervals to indicate that a new message or memo has been recorded.



Switch the alert signal on / off

Call screening

You can listen to an incoming call without actually taking the call.



Switch call screening on / off

Taking a call being recorded

It is possible to take a call even if the answering machine has already begun to take it. Recording of the message is stopped in this case.



Take the call

Recording/Controlling/Deleting outgoing messages

The answering machine is provided with two, pre-recorded outgoing messages (OGM). After OGM 1 has been played, the caller can leave a message. OGM 2 is purely an answer only announcement after which no message can be left. OGM 1 can be replaced by a message of your own. OGM 2 cannot be changed. When the answering machine memory is full, OGM 2 is automatically played.

Recording an outgoing message

An outgoing message can be up to 40 seconds long.



Start the recording function



Speak your message and confirm it

Checking the current outgoing message



Play the outgoing message

Deleting your own outgoing message, reverting to the pre-recorded message

After deleting your own outgoing message, the pre-recorded message is automatically reactivated.



Play the outgoing message



Delete the outgoing message



Answering Machine

Recording/Deleting Memos

A memo is a message left for other machine users and can be played in the same way as an incoming message. Only one memo can be recorded at a specific time.

Recording a memo

A memo cannot be longer than 2 minutes.

2 sec MEMO	Activate the recording function
 	Speak your memo and confirm it

Playing back the memo

MEMO	Play the memo
-------------	---------------





Deleting the memo

MEMO	Play the memo
DEL	Delete the memo

Playing/Deleting recorded messages

Playing the messages

If a memo has been recorded, it is played before any of the recorded messages. The recorded messages are played back in the sequence they were recorded.

2 sec 	Play the new messages
	Play all the messages
	Stop playback
 ALERT	Replay the message
 SCREEN	Skip to the next message

Deleting one message

	Play the message to be deleted
DEL	Delete the message

Delete all messages / memos

All the messages / memos are deleted. New messages / memos are retained.

2 sec DEL	Start the deleting process
DEL	Delete all messages / memos















Remote access

You can call your answering machine from another telephone to play messages or execute other functions. A condition is that you use a telephone which implements tone dialling.



PIN code for remote access

In order to use the remote access function, you must enter the relevant PIN code. The default security code set at the factory is "000".

 This setting is completed on the handset!

	Open the menu
 or 	Select the submenu and confirm
SETTINGS, 	Select the submenu and confirm
 or 	Select the submenu and confirm
DTAM, 	Select the function and confirm
 or 	Select the function and confirm
RA PIN CODE, 	Enter the old PIN
 	Enter the new PIN
 	Enter the new PIN again

Starting remote access

	Dial your own phone number
 *x, 	Press the button during the outgoing message and enter the security code

 If the code entry is incorrect, the OGM is repeated. If the security code is entered incorrectly three times, the line is automatically disconnected.

You can now execute other functions;  Key function assignment table.

Remote activation of the answering machine



Dial your own phone number



If you forgot to switch your answering machine on, your call is taken after 10 rings.



While the OGM is playing, press the button and enter the PIN code



Switch the answering machine on/off

You can now execute other functions; Key function assignment table.

Key function assignment for remote access



Remote access is automatically cancelled if there is no input within 8 seconds.

The functions assigned to the buttons are dependent on the mode currently activated. The following table provides an overview of the respective functions assigned to the individual buttons.

Button	Functions	Functions when playing a message
		Play the previous message
	Play the message	Play back current message again
		Play the next message
	Play the memo	
	Cancel the action	Stop the message currently being played
	Play the outgoing message	
	Record a memo	
	Switch the answering machine on/off	
	Record outgoing message	
		Delete the current message
,	Deleting all messages	
	Placing the telephone on-hook ends remote access	

7 PABX / Supplementary Services

R-button on private branch exchanges

If the telephone is connected to a private branch exchange, all the functions associated with the **R-button**, such as transferring calls, automatic call back, etc., can be used. Refer to the operating manual provided with your private branch exchange as to which Flash time must be set in order to use these functions. The dealer where you purchased the exchange can provide information as to whether the telephone will work properly with the exchange. The Flash time is set using the menu. Refer to Page 85 for the sequence of menu option selections.

Dialling pause

When using private branch exchanges, it is necessary to dial a specific number to obtain the dialling tone for an outside line. When using some older private branch exchanges, it takes a little time before the dialling tone becomes audible. In the case of such private branch exchanges, a dialling pause can be inserted after the number for an outside line in order to continue dialling directly without having to wait for the dialling tone.

2 sec # Insert a dialling pause

The actual phone number is dialled a certain time after the number for an outside line.

 The dialling pause can also be entered with the phone numbers in the phone book.

R-button and supplementary services

Your telephone supports supplementary services provided by your telephone network provider, such as brokering, call waiting and conference facilities. These supplementary services can be used by implementing the **R-button**. Please contact your telephone network provider regarding which Flash time must be set to use the supplementary services. Please contact the telephone network provider with regard to enabling the supplementary services. The Flash time is set using the menu. Refer to Page 85 for the sequence of menu option selections.

Caller number display (CLIP¹)



The caller number display (CLIP) is a supplementary service offered by your telephone network provider. Contact your network provider for further information.

If this function is available with your telephone line, the number of the caller appears in the display when the phone rings. If the caller has suppressed transmission of his phone number, the corresponding message appears in the display. The phone number is not displayed and, as a result, is not stored in the call log.

Answering machine in the telephone network





An answering machine in the telephone network is a supplementary service offered by many telephone network providers. If your telephone network provider offers an answering machine in the telephone network for you, you are informed of new messages received by an icon (**VMWI**²). This function can only be used when your telephone network provider actually offers the service. Contact your network provider for further information.



¹ **CLIP**: Calling Line Identification Presentation = Display the caller's phone number.

² **VMWI**: Visual Message Waiting Indication = Visual indicator that new messages have been recorded.

8 Menu Structure

Main menu

Open the main menu by pressing the  button. Use the  /  buttons to move to and select an option then confirm it by pressing the  button.

PHONEBOOK	ADD RECORD	NAME?	NUMBER?
	EDIT RECORD		
	DELETE	 / 	CONFIRM?
	DELETE ALL	CONFIRM?	
DISPLAY	HANDSET NAME		
	BACKLIGHT	ON	OFF
	LANGUAGE	ENGLISH, ITALIANO, DEUTSCH, FRANCAIS	
SOUND	HANDSET	MELODY	MELODY 1-10
		LEVEL	OFF, 1-5
	BASE	MELODY	MELODY 1-10
		LEVEL	OFF, 1-5
	KEY TONES	ON	OFF
	TONES	ON	OFF
SETTINGS	DTAM	RING DELAY	1-7, TOLL SAVER
		RA PIN CODE	NEW PIN REPEAT
	AUTO ANSWER	ON	OFF
	DIAL MODE	TONE	PULSE
	RECALL	RECALL 1-2	(100 ms / 300 ms)



Menu Structure



SYSTEM	REGISTER	PIN (0000)	1 2 3 4	SEARCHING BS
	SELECT BASE	AUTO BASE	BASE 1-4 1-4	
	DELETE HS	HANDSET 1-4 1-4	PIN	
	PIN	PIN	NEW PIN	REPEAT
	ECO MODE	ON	OFF	
	RESET	PIN		

9 Phone Book / Call Log

Phone book

You can use the phone book to store up to 20 phone numbers together with the associated names.

- Always enter the area access code with the phone numbers so that incoming local calls can also be assigned to a phone book entry.
- When the memory capacity is used up, the corresponding message appears in the display on the next attempt to store one. To create space, an existing entry must first be deleted.
- The phone book entries are arranged alphabetically. To access the required phone book entry directly, press the first letters of the corresponding name.

Entering names

Letters are also imprinted on the digit keys. Letters and digits are entered by pressing the relevant key the respective number of times.



Enter a space



Delete characters



If a name already exists in the phone book, the message DUPLICATE appears. Change the name.



To enter the same letter twice, press the button to enter the letter. Wait until the cursor skips one position forwards. Enter the letter again.

Call log

A total of 20 calls are stored in the call log.



The caller number display (**CLIP**¹) is a supplementary service offered by your telephone network provider. The caller number appears in the display if the service is offered by your telephone network provider. Contact your network provider for further information.

¹ **CLIP**: Calling Line Identification Presentation = Display the caller's phone number.

Displaying numbers in the call log



Open the call log and select the entry required

Storing a phone number in the call log in the phone book

A phone number in the call log can be stored in the phone book directly.

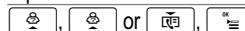

Open the call log and select the entry required



Start the saving process



Enter the name and confirm it



Edit the number, if necessary, and confirm it



As soon as the phone number in the phone book has been saved together with a name, the name entered appears in the call log.

Deleting phone numbers from the call log

Deleting phone numbers individually

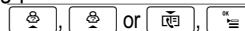

Open the call log and select the entry required

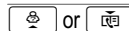

Activate the deleting process

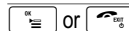

Confirm the deleting process or cancel it

Deleting all the phone numbers



Open the call log

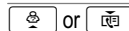

Activate the deleting process



Confirm the deleting process or cancel it

Special Functions

10 Special Functions

Dialling mode

The telephone can be operated in analogue exchanges (PULSE) as well as new, digital exchanges (TONE/DTMF). The dialling mode is controlled via the menu. Refer to Page 85 for the sequence of menu option selections.

Temporary tone dialling

If you only operate the telephone using the PULSE dialling mode, you can still make use of the advantages of the TONE dialling mode (e.g.: remote access of the answering machine in the telephone network). During a call, you can temporarily switch to Tone dialling.

1 sec

Press when a connection has been established

When the call is ended, the equipment automatically switches back to Pulse dialling.

11 Extending the Telephone System

The internationally approved **GAP**¹ standard regulates the compatibility of handsets and base stations from different manufacturers. As a result, it is possible to integrate SWITEL devices and devices from other manufacturers together in one telephone system. It is possible, however, that some functions are not available.



Multiple handsets

Up to 4 handsets can be registered on the base station.

Registering handsets

Before starting to register a handset, switch the base station to Register mode.

4 sec  , Activate Registration mode

Now register the handset;  Page 86. The currently valid PIN code is used for registration purposes;  Page 86.

The handset is automatically assigned an internal call number following registration. The internal call number appears in the display.

 To register handsets from other manufacturers, please refer to the operating manual supplied with them.

Deregistering handsets

 A handset can only be deregistered from a base station using another handset registered to that base station.

Handsets are deregistered via the menu.
Refer to Page 86 for the sequence of menu option selections.



Multiple base stations

You can increase the range of your handset by registering it on several base stations. It can be simultaneously registered on up to 4 different base stations. Each base station requires its own telephone line socket. Connections can be used with the same call number or with different ones.

 Calls in progress cannot be transferred from one base station to another.

Increasing the range

Position the base stations so that the ranges of the individual base stations overlap. Test the ranges of the handsets because obstructions in buildings restrict the range. Register the handset on all the base stations. Activate the **AUTO** function on the base station;  Page 86. The handset then automatically searches for the nearest base station with the best connection.

 If necessary, you can increase the range of the telephone system by switching ECO mode off  Page 86 (ECO MODE → OFF).

Mobility through registration at various locations

Register the handset on various base stations at different locations. Activate the **AUTO** function on the base station;  Page 86. Regardless of your current location, the handset automatically searches for a base station within range.

¹ **GAP**: Generic Access Profile = Standard for the interoperation of handsets and base stations from different manufacturers.

In Case of Problems

12 In Case of Problems

Service Hotline

Should problems arise with the telephone, please refer to the following information first. In the case of technical problems, you can contact our hot-line service, Tel. 0900 00 1675 within Switzerland (cost via Swisscom at time of going to print: CHF 2.00/min). In the case of claims under the terms of guarantee, contact your sales outlet. There is a 2 year period of guarantee.

Problems and solutions

Problems	Solutions
No connection to base station possible	<ul style="list-style-type: none">- Check that the handset has been registered on the base station with the correct PIN code; ☞ Page 86.
No telephone calls possible	<ul style="list-style-type: none">- The telephone is not connected properly or is defective. Only use the telephone connection cable supplied.- Test whether the telephone connection is in order by using another telephone.- The power adaptor plug is not plugged in or there is a complete power failure.- The rechargeable batteries are empty or defective.- The handset is too far from the base station.- Dialling mode is set incorrectly; ☞ Page 85.

Connection is disturbed or cut off	<ul style="list-style-type: none">- The handset is too far from the base station.- The base station is in an unsuitable location.
The system no longer responds	<ul style="list-style-type: none">- Reset all the functions to their default settings; ☞ Page 86.- Disconnect the power adapter plug briefly from the power socket.
The batteries are empty within a short time	<ul style="list-style-type: none">- The batteries are empty or defective.- Place the handset in the base station properly. Clean the contact surfaces on the handset and base station with a soft, dry cloth.- Place the handset in the base station for 14 hours.
The caller number display (CLIP ¹) does not function	<ul style="list-style-type: none">- The caller number display function is a supplementary service offered by telephone network providers. Contact your network provider for further information.- The caller has suppressed the transmission of their phone number.
The answering machine does not record any messages	<ul style="list-style-type: none">- Ensure that the answering machine is connected correctly and switched on.- Check whether the answering machine memory is full. Delete messages from the memory, if necessary; ☞ Page 82.

¹ **CLIP:** Calling Line Identification Presentation = Display the caller's phone number.

No memo can be recorded	<ul style="list-style-type: none">- Check whether a memo has already been recorded. Delete the old memo, if necessary; ☞ Page 82.- Check whether the answering machine memory is full. Delete messages from the memory, if necessary; ☞ Page 82.
Remote access is not possible	<ul style="list-style-type: none">- Check that the correct security code has been entered for the remote access; ☞ Page 82.- The telephone used for remote access must be set to tone dialling.

Technical Properties

13 Technical Properties

Technical data

Feature	Value
Standard	DECT¹-GAP²
Power supply (base station) with answering machine	Input: 220/230 V, 50 Hz Output: 9 V, 500 mA
Power supply (charging station)	Input: 220/230 V, 50 Hz Output: 6 V, 150 mA
Range	Outdoors: Approx. 300 m Indoors: Approx. 50 m
Standby	Up to 120 h
Max. talk time	Up to 12 h
Rechargeable batteries	2 x AAA NiMH 1,2 V
Dialling mode	Tone dialling mode Pulse dialling mode
Permissible ambient temperature	10 °C to 30 °C
Permissible relative humidity	20 % to 75 %
Flash function	100 ms, 300 ms

¹ **DECT**: Digital Enhanced Cordless Telecommunication = Standard for cordless telephones.

² **GAP**: Generic Access Profile = Standard for the interoperation of handsets and base stations from different manufacturers.

Default settings

The default settings can be restored via the menu. Refer to Page 86 for the sequence of menu option selections.

Handset

Language	ENGLISH
Auto answer	ON
Dialling mode	TONE
Melody	1
Ringing volume	3
Key tone	ON
Receiver volume	2
ECO mode (ECO MODE)	OFF

Base station

PIN code	0000
----------	------

Answering machine

Remote access security code	000
-----------------------------	-----

Declaration of Conformity

This device fulfils the requirements stipulated in the EU directive:

1999/5/EU directive on radio equipment and telecommunications terminal equipment and the mutual recognition of their conformity. Conformity with the above mentioned directive is confirmed by the CE symbol on the device.



To view the complete Declaration of Conformity, please refer to the rear side of this user guide.

14 Maintenance / Guarantee

Maintenance

- Clean the housing surfaces with a soft, fluff-free cloth.
- Never use cleaning agents or solvents.

Guarantee

SWITEL equipment is produced and tested according to the latest production methods. The implementation of carefully chosen materials and highly developed technologies ensure trouble-free functioning and a long service life. The terms of guarantee do not apply where the cause of equipment malfunction is the fault of the telephone network operator or any interposed private branch extension system. The terms of guarantee do not apply to the batteries or power packs used in the products. The period of guarantee is 24 months from the date of purchase.

All deficiencies related to material or manufacturing errors within the period of guarantee will be redressed free of charge. Rights to claims under the terms of guarantee are annulled following tampering by the purchaser or third parties. Damage caused as the result of improper handling or operation, normal wear and tear, incorrect positioning or storage, improper connection or installation or Acts of God and other external influences are excluded from the terms of guarantee. In the case of complaints, we reserve the right to repair defect parts, replace them or replace the entire device. Replaced parts or devices become our property. Rights to compensation in the case of damage are excluded where there is no evidence of intent or gross negligence by the manufacturer.

If your device does show signs of a defect within the period of guarantee, please contact the sales outlet where you purchased the SWITEL device, producing the purchase receipt as evidence. All claims under the terms of guarantee in accordance with this agreement can only be asserted at the sales outlet. No claims under the terms of guarantee can be asserted after a period of two years from the date of purchase and hand-over of the product.

15 Index

A

Alert signal, 81
Answer delay, 81
Answering machine, 81
Answering machine in the telephone network, 84

B

Base station, 74, 76, 89
Battery charge status, 75
Brokering, 80

C

Call back, 79
Call log, 87
Call screening, 81
Caller number display, 84, 87
Charges, 81
Charging, 75
Charging station, 74
CLIP, 84
Conference calls, 80
Controlling, 81, 82
Creating, 78

D

Declaration of Conformity, 92
Default settings, 92
Deleting, 81, 82, 87
Deregistration, 89
Dialling, 79
Dialling mode, 88
Dialling pause, 84
Display, 77
Display icons, 77

E

ECO mode, 75
Ending a call, 79
Energy-save mode, 78
Entering names, 87
Entering text, 87
Extending, 89

F

Forwarding calls, 79
Functions, 88

G

Guarantee, 93

H

Handsets, 89
Holding a call, 80

I

Icons, 77
Inserting the batteries, 75
Internal calls, 79

K

Key function assignment, 83
Key lock, 80

L

Low-radiation, 75

M

Main menu, 85
Maintenance, 93
Making a call, 79
Menu structure, 85
Messages, 82
Muting, 80
Muting button, 80

N

Navigation buttons, 78
Notation, 77
Number of rings, 81

O

Off-hook, 79
On-hook, 79
Operating elements, 76
Operation, 77
Outgoing messages, 81, 82

P

Package contents, 74
Paging, 80
Phone book, 79, 87
Phone book entries, 78
PIN code, 82
Playing back, 82
Private branch exchanges, 75, 84
Problems, 90
Problems and solutions, 90
Pulse dialling mode, 88

R

R-button, 84
Range, 89
Receiver volume, 80
Recording, 81, 82
Recording time, 81
Redialling, 79
Registering, 89
Remote access, 82
Remote activation, 83
Ringing melody, 80

S

Safety information, 73
Saving, 78
Searching, 80
Service-Hotline, 90
Standby mode, 78
Starting up, 74
Storing, 87
Supplementary services, 84
Switching off, 80, 81
Switching on, 80, 81

T

Taking a call, 75, 79
Taking a call being recorded, 81
Talk time, 80
Technical data, 92
Telephoning, 79
Temporary tone dialling, 88
Tone dialling mode, 88
Transferring calls, 79
Troubleshooting, 90

V

VMWI, 84
Volume, 81

SWITEL

Declaration of conformity

WE TELGO AG
OF Route d'Englisberg 11
CH-1763 Granges-Paccot

Declare under our own responsibility that the product

MODEL: DET217x
DESCRIPTION: Cordless DECT telephone with answering machine

Is in conformity with directives: R&TTE Directive (1999/5/EC)

COMPLIANCE IS ACHIEVED BY CONFORMITY TO THE FOLLOWING:

EN 60950-1: 2001, EN 41003: 1998, EN 301 489-1/-6: V1.5.1/V1.2.1, EN 301 406: V1.5.1

AUTHORISED BY:

Signed:



Name (printed): Selim Dusi
Position in company: Managing Director

Date of issue: 13.06.2007

Copies of this document will be held on file for a period of 10 years after the last production.



Supplier: TELGO AG, Route d'Englisberg 11
CH-1763 Granges-Paccot
Product: DET217x

This product is intended for connection to analogue PSTN lines within Switzerland. However, due to differences between the individual PSTNs provided in the different countries, the approval does not, of itself, give an unconditional assurance of successful operation on every PSTN network termination point.