

SWITEL

COMMUNICATION PRODUCTS

Schnurlostelefon

Téléphone sans fil

Telefono senza fili

Cordless telephone

DE 27x



Bedienungsanleitung
Mode d'emploi
Istruzioni per l'uso
Operating Instructions

D

F

I

GB

1	Sicherheitshinweise	2
2	Telefon in Betrieb nehmen	4
3	Bedienelemente	7
4	Einführende Informationen	9
5	Telefonieren	13
6	Weitere Leistungsmerkmale	17
7	Anrufliste / Wahlwiederholung	18
8	Telefonbuch	19
9	Telefon einstellen	21
10	Mobilteile an-/abmelden	25
11	Betrieb an Telefonanlagen/Zusatzdienste	26
12	Anhang	27

1 Sicherheitshinweise

Lesen Sie diese Bedienungsanleitung sorgfältig durch.

Bestimmungsgemäße Verwendung

Dieses Telefon ist geeignet zum Telefonieren innerhalb eines Telefonnetzes. Jede andere Verwendung gilt als nicht bestimmungsgemäß. Eigenmächtige Veränderungen oder Umbauten sind nicht zulässig. Öffnen Sie das Gerät in keinem Fall selbst und führen Sie keine eigenen Reparaturversuche durch.

Aufstellungsort

Vermeiden Sie Belastungen durch Rauch, Staub, Erschütterungen, Chemikalien, Feuchtigkeit, Hitze oder direkte Sonneneinstrahlung. Verwenden Sie das Mobilteil nicht in explosionsgefährdeten Bereichen.

Netzteil

 **Achtung:** Verwenden Sie nur das mitgelieferte Steckernetzteil, da andere Netzteile das Telefon beschädigen können. Sie dürfen den Zugang zum Steckernetzteil nicht durch Möbel oder andere Gegenstände versperren.

Aufladbare Akkus

 **Achtung:** Werfen Sie Akkus nicht ins Feuer. Verwenden Sie nur Akkus des gleichen Typs! Achten Sie auf die richtige Polung! Bei verkehrter Polung der Akkus besteht beim Aufladen Explosionsgefahr.

Stromausfall

Bei Stromausfall kann mit dem Telefon nicht telefoniert werden. Halten Sie für Notfälle ein schnurgebundenes Telefon bereit, welches ohne externe Stromversorgung arbeitet.

Medizinische Geräte

 **Achtung:** Benutzen Sie das Telefon nicht in der Nähe von medizinischen Geräten. Eine Beeinflussung kann nicht völlig ausgeschlossen werden.

DECT¹-Telefone können in Hörgeräten einen unangenehmen Brummtönen verursachen.

Entsorgung

Wollen Sie Ihr Gerät entsorgen, bringen Sie es zur Sammelstelle Ihres kommunalen Entsorgungsträgers (z. B. Wertstoffhof). Das nebenstehende Symbol bedeutet, dass Sie das Gerät auf keinen Fall in den Hausmüll werfen dürfen! Nach dem Elektro- und Elektronikgerätegesetz sind Besitzer von Altgeräten gesetzlich gehalten, alte **Elektro- und Elektronikgeräte** einer getrennten Abfallerfassung zuzuführen.

Akkus entsorgen Sie beim batterievertreibenden Handel sowie bei zuständigen Sammelstellen, die entsprechende Behälter bereitstellen.

Verpackungsmaterialien entsorgen Sie entsprechend den lokalen Vorschriften.



¹ DECT: **D**igital **E**nhanced **C**ordless **T**elecommunication = Standard für kabellose Telefone.

2 Telefon in Betrieb nehmen

Sicherheitshinweise

 **Achtung:** Lesen Sie vor der Inbetriebnahme unbedingt die Sicherheitshinweise in Kapitel 1.

Verpackungsinhalt prüfen

Zum Lieferumfang gehören:

Inhalt	DE 27x-Modell			
	271 ¹	272 ¹	273 ¹	274 ¹
Basisstation mit Netzteil	1	1	1	1
Ladestation mit Netzteil	-	1	2	3
Mobilteil	1	2	3	4
Telefonanschlusskabel	1	1	1	1
Akkus	2	4	6	8
Bedienungsanleitung	1	1	1	1

¹ Unter www.switel.com erfahren Sie, ob dieses Telefonset bereits erhältlich ist.

Stromverbrauch

Die **Leistungsaufnahme der Basisstation** beträgt:

- im Betrieb (Bereitschaft/Gespräch): ca. 1,2 W
- während der Ladung des Mobilteils: ca. 2 W.

Die Nulllast des Netzteils beträgt ca. 0,15 W.

Die durchschnittliche Effizienz beträgt ca. 60 %.

Die **Leistungsaufnahme der Ladestation** beträgt:

- ohne Mobilteil: ca. 0,15 W
- während der Ladung des Mobilteils: ca. 1,2 W.

Die Nulllast des Netzteils beträgt ca. 0,15 W.

Die durchschnittliche Effizienz beträgt ca. 60 %.

Basisstation anschließen

⚠ Achtung: Stellen Sie die Basisstation mit einem Mindestabstand von 1 m zu anderen elektronischen Geräten auf, da es sonst zu gegenseitigen Störungen kommen kann.

Schließen Sie die Basisstation wie auf der Skizze abgebildet an. Verwenden Sie aus Sicherheitsgründen nur das mitgelieferte Netzteil sowie das beigegefügte Telefonanschlusskabel.

Netzsteckdose



Telefonanschluss

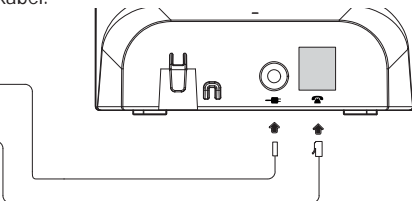

⚠ Achtung: Verwenden Sie für die Basisstation nur das mitgelieferte Netzteil S002CV0600030 / 6V, 300 mA DC!

Ladestation anschließen²

Schließen Sie die Ladestation wie auf der Skizze abgebildet an. Verwenden Sie aus Sicherheitsgründen nur das mitgelieferte Netzteil.

Netzsteckdose

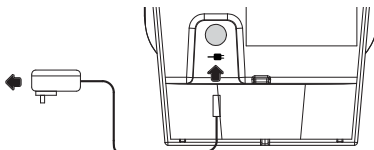

⚠ Achtung: Verwenden Sie für die Ladestation nur das mitgelieferte Netzteil S002CV0600030 / 6V, 300 mA DC!

² Gilt nur für Telefonsets mit mindestens zwei Mobilteilen, siehe „Verpackungsinhalt prüfen“.

Telefon in Betrieb nehmen

Akkus einlegen

Öffnen Sie das Akkufach. Legen Sie die Akkus in das Akkufach ein. Schließen Sie das Akkufach.

⚠ **Achtung:** Verwenden Sie nur NiMH-Akkus vom Typ AAA (Microzellen)!

Niemals Batterien/Primärzellen verwenden!

Achten Sie auf die richtige Polarität!

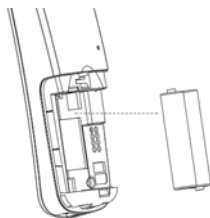

Akkus aufladen

🔌 Stellen Sie das Mobilteil bei der ersten Inbetriebnahme für mindestens 16 Stunden in die Basisstation / Ladestation.

Das Mobilteil erwärmt sich beim Laden. Dies ist normal und ungefährlich. Laden Sie das Mobilteil nicht mit fremden Aufladegeräten. Der Akkuladestandard wird im Display angezeigt. Wenn die Ladung der Akkus die untere Grenze erreicht hat, blinkt das Akkusymbol (🔋) im Display und Sie hören den Akku-Warnton (falls Akku-Warnton eingeschaltet / Menüpunkt „MT-EIN- STEL./TONE/AKKU LEER“). Sie haben noch ca. 10 Minuten Gesprächszeit.

Datum und Uhrzeit des Mobilteils einstellen

Bei Inbetriebnahme verfügt das Mobilteil nicht über eine korrekte Uhrzeit (z. B. für Einträge in der Anrufliste). Datum und Uhrzeit stellen Sie über den Menüpunkt „MT-EIN- STEL./ DATUM & ZEIT“ ein.

Displaysprache einstellen

Die Displaysprache ist in 13 verschiedenen Sprachen einstellbar. Im Auslieferungszustand ist „Deutsch“ eingestellt. Sie können die Sprache über den Menüpunkt „MT-EIN- STEL./ SPRACHE“ ändern.

Automatische Rufannahme / Direktannahme

Ist die Funktion aktiviert (Auslieferungszustand), wird ein Anruf automatisch beim Herausnehmen des Mobilteils aus der Basisstation angenommen. Die automatische Rufannahme wird über den Menüpunkt „MT-EIN- STEL./ AUTO- ANTWORT“ ein- oder ausgeschaltet.

3 Bedienelemente

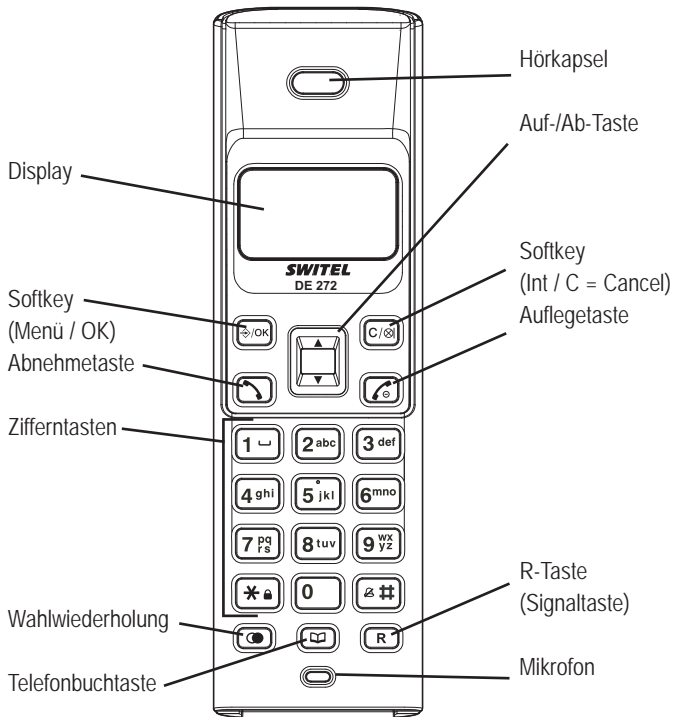



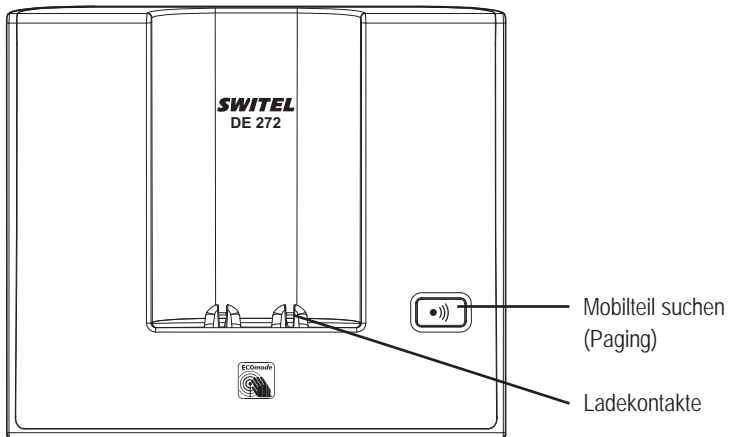



Bedienelemente









4 Einführende Informationen

In diesem Kapitel finden Sie grundlegende Informationen zur Handhabung der Bedienungsanleitung und des Telefons.

Darstellungweise in der Bedienungsanleitung

Darstellung	Beschreibung
	Darstellung von Tasten
	Abgebildete Taste drücken
	Ziffern oder Buchstaben eingeben
	Mobilteil klingelt
	Mobilteil aus der Basisstation nehmen
	Mobilteil in die Basisstation stellen
NAME?	Darstellung von Display-Texten
	Darstellung von Display-Symbolen

Symbole im Display des Mobilteils

Symbol	Beschreibung
	Konstant: Verbindung zur Basisstation. Blinkt: keine Verbindung zur Basisstation.
	Konstant: Anzeige der Batteriekapazität. Blinkt während Mobilteil in der Basis: Die Akkus werden geladen.
	Konstant: Akkus sollten geladen werden. Blinkend: Laden Sie die Akkus.
	Konstant: Sie führen ein Gespräch. Blinkend: Sie erhalten gerade einen Anruf.
	Tonruf ist ausgeschaltet.
	Konstant: Eine Weckzeit ist eingestellt. Blinkt: Die eingestellte Weckzeit ist erreicht.
	Tastensperre ist eingeschaltet.

Einführende Informationen



Sie haben eine Nachricht in der Sprachbox Ihres Netzbetreibers (abhängig vom Netzbetreiber)



Konstant: Sie führen ein Interngespräch (nur bei mehreren Mobilteilen an einer Basis).



Blinkt: Eintreffendes Interngespräch.



Während Anzeige der Anrufliste: Neuer Anruf

Weitere Ziffern/Buchstaben vor bzw. hinter den gegenwärtig angezeigten. Um diese anzuzeigen drücken Sie den jeweiligen Softkey.

In der unteren Displayzeile werden zugehörig zu den beiden **Softkeys** die abhängig vom Betriebszustand verfügbaren Funktionen angezeigt.



Aufruf des Menüs.



Bestätigung einer Einstellung.



Aufbau eines Interngesprächs (nur bei mehreren Mobilteilen an einer Basis).



Zurück zum übergeordneten Menü bzw. Abbruch der Programmierung.



Rückwärts-Löschen von Zeichen bei der Eingabe (kurzer Druck löscht letztes Zeichen, langer Druck die ganze Zeile),

Mikrofon aus-/einschalten während eines Gesprächs (Mute)

Bereitschaftsmodus

Alle Beschreibungen in dieser Bedienungsanleitung gehen davon aus, dass sich das Mobilteil im Bereitschaftsmodus befindet. Den Bereitschaftsmodus erreichen Sie, indem Sie die Taste  drücken.

Strahlungsreduzierung (ECO-Mode)



Im Gesprächsmodus wird die Strahlung im Vergleich zu Standard-DECT-Schnurlostelefonen erheblich reduziert.

Navigation im Menü

Alle Funktionen sind über unterschiedliche Menüs zu erreichen. Die komplette Menüstruktur finden Sie im Anhang.

Zur Navigation im Menü benutzen Sie die Softkeys und die Pfeiltasten.

Mit dem linken Softkey  öffnen Sie das Menü.

Mit den Pfeiltasten  bzw.  bewegen Sie sich im Menü.

Zum Öffnen eines Untermenüs drücken Sie den Softkey .

Wollen Sie zum übergeordneten Menü zurück drücken Sie  kurz. Bei langem Druck gelangen Sie wieder in den Bereitschaftszustand.

Beispiel: Telefonbucheintrag anlegen

Wie Sie in den Menüs navigieren und Einstellungen vornehmen, ist hier anhand des Beispiels zum Anlegen eines Telefonbucheintrags erklärt. Verfahren Sie bei allen Einstellungen wie in diesem Beispiel.



Drücken Sie die Telefonbuchtaste.

oder



Drücken Sie den Softkey **Menü**.



OK

Wählen Sie **TELEFONBUCH** und bestätigen Sie mit **OK**.

Ist noch kein Eintrag vorhanden wird **LEER** angezeigt. Sind bereits Einträge vorhanden wird der erste Eintrag angezeigt.



Drücken Sie den Softkey **Menü**.



Bestätigen Sie **EINTRAG NEU** mit **OK**.



Geben Sie den Namen ein (maximal 12 Zeichen).

Die Ziffern-Tasten sind mit Buchstaben beschriftet. Durch mehrmaliges Drücken der entsprechenden Taste können Buchstaben und Ziffern eingegeben werden.

Nach kurzer Zeit springt die Einfügemarke (Cursor) weiter.



Schließen Sie die Eingabe des Namens mit **OK** ab.



Geben Sie die Rufnummer ein (maximal 20 Ziffern).



Schließen Sie die Eingabe der Rufnummer mit **OK** ab.



Wählen Sie eine Melodie für den Eintrag aus.



Bestätigen Sie mit **OK**.



Zurück zum Bereitschaftsmodus.

5 Telefonieren

Anruf annehmen



Ihr Telefon klingelt.

Befindet sich das Mobilteil **nicht** in der Basis:



Drücken Sie die Abnehmetaste.

Befindet sich das Mobilteil in der Basis und **AUTO-ANTWORT** ist **nicht** eingeschaltet:



Nehmen Sie das Mobilteil aus der Basis und drücken Sie die Abnehmetaste.

Befindet sich das Mobilteil in der Basis und **AUTO-ANTWORT** ist eingeschaltet:



Nehmen Sie einfach das Mobilteil aus der Basis; das Gespräch wird automatisch angenommen.

Anrufen



Geben Sie die Rufnummer ein.

Fehler bei der Eingabe mit  korrigieren.



Rufnummer wird gewählt.



 Sie können auch zuerst die Abnehmetaste drücken und erhalten damit das Freizeichen. Die eingegebenen Ziffern Ihrer gewünschten Rufnummer werden sofort gewählt. Eine Korrektur einzelner Ziffern der Rufnummer ist bei dieser Form des Gesprächsaufbaus nicht möglich.

Gespräch beenden



Auflegetaste drücken oder Mobilteil in die Basis stellen.

Wahlwiederholung



 Ihr Telefon speichert die 5 zuletzt gewählten Rufnummern. Ist für die Rufnummer ein Telefonbucheintrag angelegt, wird der Name angezeigt. Um die zugehörige Rufnummer anzuzeigen drücken Sie die Raute-Taste . Die zuletzt gewählte Rufnummer steht immer am Anfang der Liste.

 Öffnen Sie die Wahlwiederholungsliste.

 Wählen Sie einen Eintrag aus.

 Rufnummer wird gewählt.

Aus der Anrufliste anrufen

 Ihr Telefon speichert die letzten 10 Anrufe in der Anrufliste. Ist für die Rufnummer ein Telefonbucheintrag angelegt, wird der Name angezeigt. Um die zugehörige Rufnummer anzuzeigen drücken Sie die Raute-Taste . Die Speicherung kann nur erfolgen, wenn die Funktion „Rufnummernübertragung (CLIP)“ an Ihrem Anschluss verfügbar ist und die Rufnummer vom Anrufer nicht unterdrückt oder aus anderen Gründen nicht übertragen wurde.

 Öffnen Sie die Anrufliste.

 Wählen Sie einen Eintrag aus.

 Rufnummer wird gewählt.

Aus dem Telefonbuch anrufen

 Das Telefonbuch kann 20 Einträge aufnehmen. Zum Anlegen von Einträgen siehe Abschnitt „Telefonbuch“.

 Öffnen Sie das Telefonbuch.

 Wählen Sie einen Eintrag aus.

 Rufnummer wird gewählt.

Anzeige der Gesprächsdauer

Während eines Gesprächs wird die Gesprächsdauer in Stunden, Minuten und Sekunden angezeigt.

Hörerlautstärke einstellen



Sie können während eines Gesprächs die Lautstärke in 5 Stufen einstellen. Die Einstellung bleibt nach Ende des Gesprächs gespeichert.

Mikrofon ausschalten (Mute)



Sie können während eines Gesprächs das Mikrofon ausschalten, so dass Ihr Gesprächspartner Sie nicht hören kann. Im Display wird **STUMM** angezeigt.



Zum Einschalten des Mikrofons drücken Sie die Taste erneut.

Intern telefonieren

 Interne Gespräche, Vermitteln und Konferenzgespräche sind nur möglich, wenn mehrere Mobilteile angemeldet sind. Ist dies nicht der Fall, wird im Display **NICHT MOGL.** angezeigt.

Internes Gespräch führen



Drücken Sie den Softkey **Intern**. Sind zwei Mobilteile angemeldet, wird das andere Mobilteil sofort gerufen. Bei mehreren angemeldeten Mobilteilen werden deren interne Nummern angezeigt (z. B. 2 3 4). Drücken Sie die gewünschte interne Nummer.

Drücken Sie bei mehreren angemeldeten Mobilteilen „9“, werden alle gleichzeitig gerufen.

Externes Gespräch vermitteln



Während eines Externgesprächs . . .

Drücken Sie den Softkey **Menü**.



Wählen Sie **INTERN** aus und drücken Sie **OK**.



Geben Sie die interne Rufnummer ein. Das externe Gespräch wird gehalten.

Wenn das gerufene Mobilteil eingeschaltet wird ggf. Gespräch ankündigen.



Drücken Sie die Auflegetaste. Das Gespräch ist übergeben.

Konferenz



Während eines Externgesprächs . . .

Drücken Sie den Softkey **Menü**.



Wählen Sie **INTERN** aus und drücken Sie **OK**.



Geben Sie die interne Rufnummer ein.



Wenn das gerufenene Mobilteil eingeschaltet wird drücken und halten Sie die Stern-Taste bis **KONFERENZ** im Display erscheint.

 Legt einer der beteiligten Konferenzteilnehmer auf, bleiben die beiden anderen miteinander verbunden.

6 Weitere Leistungsmerkmale

Tastensperre

 Die Tastensperre verhindert ein unbeabsichtigtes Betätigen der Tasten. Eintreffende Anrufe können wie gewohnt entgegengenommen werden.



Drücken und halten Sie die Stern-Taste bis im Display das Symbol für die Tastensperre erscheint.



Zum Entsperren der Tastatur drücken und halten Sie die Stern-Taste erneut bis das Symbol wieder erlischt.

Tonruf am Mobilteil ausschalten

 Sie können den Tonruf auch über das Menü „MT-EINTEL./TONRUF“ ausschalten.



Drücken und halten Sie die Raute-Taste bis im Display das Symbol für den ausgeschalteten Tonruf  erscheint.



Zum Wiedereinschalten des Tonrufs drücken und halten Sie die Raute-Taste erneut bis das Symbol wieder erlischt.

Mobilteil ausschalten

 Sie können das Mobilteil ausschalten um die Akkus zu schonen.



Drücken Sie die Auflegetaste und halten Sie sie gedrückt. Nach wenigen Sekunden wird das Mobilteil ausgeschaltet. Die Displaybeleuchtung erlischt.



Zum Wiedereinschalten des Mobilteils drücken Sie die Auflegetaste so lange, bis Sie einen Signalton hören und das Display wieder leuchtet.

7 Anrufliste / Wahlwiederholung

Anrufliste bearbeiten



Öffnen Sie die Anrufliste.



Wählen Sie einen Eintrag aus.



Drücken Sie den Softkey **Menü**.



Wählen Sie aus den folgenden Möglichkeiten und bestätigen Sie mit **OK**:

NR.SPEICHERN Die Rufnummer wird im Telefonbuch gespeichert. Geben Sie einen Namen ein, bestätigen oder bearbeiten Sie die Rufnummer und legen Sie eine Tonrufmelodie für diesen Eintrag fest.

LOSCHEN Der Eintrag wird gelöscht.

ALLE LOSCHEN Die gesamte Liste wird nach einer Sicherheitsabfrage gelöscht.

DETAILS Datum und Uhrzeit des Anrufs werden angezeigt.

Sie können die Anrufliste auch über das Menü öffnen:



Wahlwiederholung bearbeiten



Öffnen Sie die Wahlwiederholung.



Wählen Sie einen Eintrag aus.



Drücken Sie den Softkey **Menü**.



Wählen Sie aus den folgenden Möglichkeiten und bestätigen Sie mit **OK**:

NR.SPEICHERN Die Rufnummer wird im Telefonbuch gespeichert. Geben Sie einen Namen ein, bestätigen oder bearbeiten Sie die Rufnummer und legen Sie eine Tonrufmelodie für diesen Eintrag fest.

LOSCHEN Der Eintrag wird gelöscht.

ALLE LOSCHEN Die gesamte Liste wird nach einer Sicherheitsabfrage gelöscht.

8 Telefonbuch

 Im Telefonbuch können Sie 20 Rufnummern und zugehörige Namen speichern. Sie können jedem Eintrag eine eigene Melodie zuordnen, mit der ein Anruf signalisiert werden soll. Geben Sie die Rufnummern immer mit der Ortsvorwahl ein; das ermöglicht eine korrekte Anzeige des jeweiligen Anrufers, für den ein Eintrag angelegt ist und dessen Übertragung der Rufnummer an Ihrem Anschluss verfügbar ist.

Neuen Eintrag anlegen



Drücken Sie die Telefonbuchtaste.
Ist noch kein Eintrag vorhanden wird **LEER** angezeigt.
Sind bereits Einträge vorhanden wird der erste Eintrag angezeigt.



OK



Drücken Sie den Softkey **Menü**.
Bestätigen Sie **EINTRAG NEU** mit **OK**.
Geben Sie den Namen ein (maximal 12 Zeichen).
Die Zifferntasten sind mit Buchstaben beschriftet. Durch mehrmaliges Drücken der entsprechenden Taste können Buchstaben und Ziffern eingegeben werden.

OK



Nach kurzer Zeit springt die Einfügemarke (Cursor) weiter.
Schließen Sie die Eingabe des Namens mit **OK** ab.
Geben Sie die Rufnummer ein (maximal 20 Ziffern). Ist Ihr Telefon an einer Telefonanlage angeschlossen, geben Sie die Amtskennziffer mit ein. Ist eine Wahlpause erforderlich, drücken Sie nach der Amtskennziffer die Taste **0** für ca. 2 s; im Display wird **P** angezeigt.

OK



OK



Schließen Sie die Eingabe der Rufnummer mit **OK** ab.
Wählen Sie eine Melodie für den Eintrag aus.
Bestätigen Sie mit **OK**.
Zurück zum Bereitschaftsmodus.

 Sie können das Telefonbuch auch über das Menü öffnen.

  /  TELEFONBUCH .

Telefonbucheinträge bearbeiten



Drücken Sie die Telefonbuchtaste.



Wählen Sie einen Eintrag aus.



Drücken Sie den Softkey **Menü**.



Wählen Sie aus den folgenden Möglichkeiten und bestätigen Sie mit **OK**:

EINTRAG NEU Sie können einen neuen Eintrag anlegen.

ANSEHEN Der Eintrag wird angezeigt. Mit den Pfeiltasten sehen Sie Name, Rufnummer und Melodie.

ANDERN Sie können den Eintrag ändern. Löschen Sie Buchstaben und Ziffern mit , geben Sie mit den Zifferntasten neue Buchstaben und Ziffern ein. Einzelheiten dazu siehe unter „Neuen Eintrag anlegen“.

LOSCHEN Der Eintrag wird gelöscht.

ALLE LOSCHEN Die gesamte Liste wird nach einer Sicherheitsabfrage gelöscht.

TB-STATUS Die aktuelle Belegung wird angezeigt (z. B. **07/20 BELEGT**: 7 von 20 möglichen Einträgen sind vorhanden).

9 Telefon einstellen

Datum/Zeit



Drücken Sie den Softkey **Menü**.



Wählen Sie **MT-EINSTEL.** aus und drücken Sie **OK**.



Wählen Sie **DATUM & ZEIT** aus und drücken Sie **OK**.



Wählen Sie aus den folgenden Möglichkeiten und bestätigen Sie mit **OK**:

DATUMSFORMAT Sie können die Darstellung des Datums einstellen: (TT-MM-JJ oder MM-TT-JJ).

ZEITFORMAT Sie können die Darstellung der Zeit einstellen: (24 Stunden oder 12 Stunden).

ZEIT EINST. Geben Sie mit den Zifferntasten die Uhrzeit ein.

DATUM EINST. Geben Sie mit den Zifferntasten das Datum ein.

👉 Bei einem Stromausfall geht die Einstellung verloren, wenn gleichzeitig das Mobilteil ausgeschaltet ist oder die Akkus leer sind.

Wecker



Drücken Sie den Softkey **Menü**.



Wählen Sie **MT-EINSTEL.** aus und drücken Sie **OK**.



Wählen Sie **WECKER** aus und drücken Sie **OK**.



Wählen Sie **EIN** aus und drücken Sie **OK**.



Geben Sie mit den Zifferntasten die Weckzeit ein.

SNOOZE Drücken Sie **OK**.



Wählen Sie **EIN** oder **AUS** und drücken Sie **OK**.

Ist „Snooze“ eingeschaltet, bedeutet dies, dass das Wecksignal nach 7 Minuten wiederholt wird, bis diese Funktion durch Drücken und Halten der Auflegetaste beendet wird.

Ist „Snooze“ ausgeschaltet, wird das Wecksignal einmalig zur eingestellten Zeit gegeben. Zum Quittieren des Wecksignals drücken Sie eine beliebige Taste.

Tonruf für das Mobilteil einstellen



Drücken Sie den Softkey **Menü**.



Wählen Sie **MT-EINSTEL.** aus und drücken Sie **OK**.



Wählen Sie **TONRUF** aus und drücken Sie **OK**.



Wählen Sie aus den folgenden Möglichkeiten und bestätigen Sie mit **OK**:

INTERN

Wählen Sie eine Melodie für die Signalisierung eines internen Anrufes aus.

EXTERN

Wählen Sie eine Melodie für die Signalisierung eines externen Anrufes aus.

TONRUFLAUTST Wählen Sie die Lautstärke für den Tonruf aus. Wählen Sie „TONRUF AUS“ wird das Symbol im Display angezeigt.

Hinweistöne einstellen



Drücken Sie den Softkey **Menü**.



Wählen Sie **MT-EINSTEL.** aus und drücken Sie **OK**.



Wählen Sie **TONE** aus und drücken Sie **OK**.



Wählen Sie aus den folgenden Möglichkeiten und bestätigen Sie mit **OK**:

TASTENTON

Schalten Sie den Quittungston für eine Tastenbetätigung ein oder aus.

AKKU LEER

Schalten Sie den Hinweistön ein oder aus. Der Ton signalisiert, wenn der Akku geladen werden muss.

REICHWEITE

Schalten Sie den Hinweistön ein oder aus. Der Ton signalisiert, wenn Sie sich mit dem Mobilteil am Rande der Reichweite zur Basis befinden.

Displaysprache einstellen



Drücken Sie den Softkey **Menü**.



Wählen Sie **MT-EINSTEL.** aus und drücken Sie **OK**.



Wählen Sie **SPRACHE** aus und drücken Sie **OK**.



Wählen Sie eine Sprache und bestätigen Sie mit **OK**.

Mobilteilnamen einstellen



Drücken Sie den Softkey **Menü**.



Wählen Sie **MT-EINSTEL.** aus und drücken Sie **OK**.



Wählen Sie **MT-NAME** aus und drücken Sie **OK**.



Löschen Sie den alten Namen mit **C**, geben Sie mit den Zifferntasten einen neuen Namen ein und drücken Sie **OK**.

Displayanzeige einstellen



Drücken Sie den Softkey **Menü**.



Wählen Sie **MT-EINSTEL.** aus und drücken Sie **OK**.



Wählen Sie **MT-DISPLAY** aus und drücken Sie **OK**.



Wählen Sie, ob im Bereitschaftsmodus der Name des Mobilteils oder die Uhrzeit angezeigt werden soll und bestätigen Sie mit **OK**.

Automatische Rufannahme einstellen



Drücken Sie den Softkey **Menü**.



Wählen Sie **MT-EINSTEL.** aus und drücken Sie **OK**.



Wählen Sie **AUTO-ANTWORT** aus und drücken Sie **OK**.



Wählen Sie, ob im die automatische Rufannahmen ein- oder ausgeschaltet sein soll und bestätigen Sie mit **OK**.

Bei eingeschalteter automatischer Rufannahme wird ein Anruf sofort angenommen wenn das Mobilteil aus der Basis genommen wird.

Wahlverfahren einstellen



Drücken Sie den Softkey **Menü**.



Wählen Sie **BS-EINSTEL.** aus und drücken Sie **OK**.



Wählen Sie **WAHLVERFAHR.** aus und drücken Sie **OK**.



Wählen Sie **TONWAHL** oder **IMPULSWAHL** und bestätigen Sie mit **OK**.

Für die meisten Anschlüsse ist **TONWAHL** die richtige Einstellung.

Telefon einstellen

Flashzeit einstellen



Drücken Sie den Softkey **Menü**.



Wählen Sie **BS-EINSTEL.** aus und drücken Sie **OK**.



Wählen Sie **FLASH-ZEIT** aus und drücken Sie **OK**.



Wählen Sie KURZ (100 ms), MITTEL (300 ms) oder LANG (600 ms) und bestätigen Sie mit **OK**.

PIN ändern



Drücken Sie den Softkey **Menü**.



Wählen Sie **BS-EINSTEL.** aus und drücken Sie **OK**.



Wählen Sie **PIN ANDERN** aus und drücken Sie **OK**.



Geben Sie die aktuelle PIN ein

(im Auslieferungszustand 0 0 0 0) und drücken Sie **OK**.



Geben Sie eine neue PIN ein und drücken Sie **OK**.



Geben Sie die neue PIN noch einmal ein und drücken Sie **OK**.

Die vierstellige PIN schützt einige Einstellungen vor unbefugtem Zugriff. Wenn Sie die PIN vergessen haben wenden Sie sich bitte an unsere Service-Hotline.

Telefon in den Auslieferungszustand zurücksetzen



Drücken Sie den Softkey **Menü**.



Wählen Sie **RÜCKSETZEN** aus und drücken Sie **OK**.



Geben Sie die aktuelle PIN ein und drücken Sie **OK**.

Bestätigen Sie auch die nachfolgende Sicherheitsabfrage mit **OK**.

Das Telefonbuch wird nicht gelöscht. Bitte löschen Sie das Telefonbuch über das Telefonbuch-Menü. Angemeldete Mobilteile bleiben angemeldet.

10 Mobilteile an-/abmelden

An einer Basisstation können bis zu 5 Mobilteile angemeldet werden. Die mit Ihrem Telefon ausgelieferten Mobilteile sind bereits an der Basis angemeldet. Zum Anmelden eines „fremden“ Mobilteils ziehen Sie bitte auch dessen Bedienungsanleitung zu Rate.

Weiteres Mobilteil des gleichen Typs anmelden



Drücken Sie den Softkey **Menü**.



Wählen Sie **ANMELDEN** aus und drücken Sie **OK**.



Geben Sie die aktuelle PIN der Basis ein, an der das Mobilteil angemeldet werden soll, und drücken Sie **OK**.



Drücken und halten Sie die Paging-Taste an der Basisstation so lange, bis der Anmelde-ton hörbar ist (ca. 5 s).

Nach einer kurzen Zeit leuchtet das Antennensymbol im Display konstant und das Mobilteil ist angemeldet.

Mobilteil löschen



Drücken Sie den Softkey **Menü**.



Wählen Sie **BS-EINSTEL.** aus und drücken Sie **OK**.



Wählen Sie **MT ABMELDEN** aus und drücken Sie **OK**.



Geben Sie die aktuelle PIN ein und drücken Sie **OK**.



Wählen Sie eines der angezeigten Mobilteile aus und drücken Sie **OK**.

Das Mobilteil, das Sie gerade benutzen, kann nicht abgemeldet werden.

11 Betrieb an Telefonanlagen/Zusatzdienste

Betrieb an Telefonanlagen

Ist Ihr Telefon an einer Telefonanlage angeschlossen, können Sie über die R-Taste Funktionen, wie z. B. Anrufe weiterleiten und automatischen Rückruf nutzen. Lesen Sie bitte in der Bedienungsanleitung Ihrer Telefonanlage, welche Flash-Zeit Sie zur Nutzung dieser Funktionen einstellen müssen. Ob Ihr Telefon an Ihrer Telefonanlage einwandfrei funktioniert, erfahren Sie bei dem Händler, bei dem die Anlage gekauft wurde.

Bitte denken Sie daran, bei Telefonbucheinträgen ggf. die Amtskennziffer und eine ggf. erforderliche Wahlpause (Ziffer „0“ lange drücken) mit einzugeben.

Zusatzdienste Ihres Netzbetreibers

Ihr Telefon unterstützt Zusatzdienste Ihres Netzbetreibers, wie z. B. Makeln, Anklopfen und Konferenz. Über die R-Taste können Sie diese Zusatzdienste nutzen. Bitte erkundigen Sie sich bei Ihrem Netzbetreiber, welche Flash-Zeit Sie zur Nutzung von Zusatzdiensten einstellen müssen. Zur Freischaltung von Zusatzdiensten wenden Sie sich bitte an Ihren Netzbetreiber.

12 Anhang

Menüstruktur

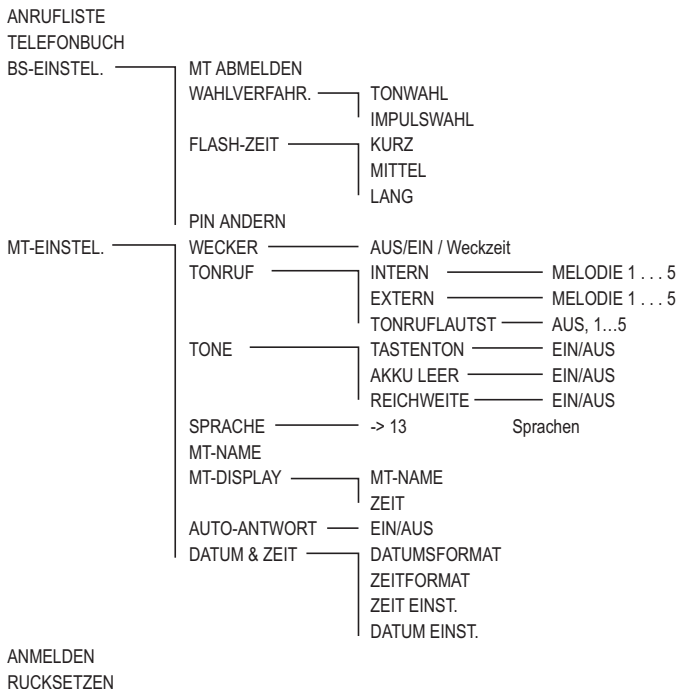

Fehlersuche

Haben Sie Probleme mit Ihrem Telefon, kontrollieren Sie zuerst die folgenden Hinweise. Bei technischen Problemen können Sie sich an unsere Service-Hotline unter Tel. 0900 00 1675 innerhalb der Schweiz (Kosten aus dem Festnetz von Swisscom bei Drucklegung: CHF 2.00/min) wenden. Bei Garantieansprüchen wenden Sie sich an Ihren Fachhändler. Die Garantiezeit beträgt 2 Jahre.

- Nach Betätigung der Abhebetaste ist kein Wählton hörbar, die Wählleitung wird nicht belegt.
 - Telefonanschluss-Stecker an der Basisstation und an der Telefonsteckdose kontrollieren.
 - Netzstecker an der Basisstation und an 230 V kontrollieren.
 - Die Wählleitung wird durch ein anderes Mobilteil belegt. Warten Sie, bis die Verbindung beendet ist.
- Displayanzeige: „SUCHE BASIS“.
 - Netzstecker an der Basisstation und an 230 V kontrollieren.
 - Reichweite verringern.
 - Mobilteil anmelden.
- Keine Anzeige auf dem Display.
 - Mobilteil ausgeschaltet -> einschalten.
 - Akku leer -> aufladen.

Werkseinstellungen/Auslieferungszustand

Anrufliste	Kein Eintrag
Telefonbuch	Kein Eintrag
Wecker	Aus
Tonruf Mobilteil	Intern: Melodie 1 Extern: Melodie 2 Tonruflautstärke: 5
Hinweistöne	Tastenton: Ein Akku leer: Ein Reichweite: Ein
Sprache	Deutsch
Mobilteilname	DE 27x
Displayanzeige	Mobilteilname
Autom. Rufannahme	Ein
Datum & Zeit	Datumsformat: TT-MM-JJ Zeitformat: 24 Stunden
Wahlverfahren	Tonwahl
Flash-Zeit	Kurz (100 ms)
PIN	0 0 0 0

Technische Daten

Standard: DECT / GAP

Kanalzahl: 120 Duplexkanäle

Frequenzen: 1880 MHz bis 1900 MHz

Duplexverfahren: Zeitmultiplex, 10ms Rahmenlänge

Kanalraster: 1728 kHz

Bitrate: 1152 kBit / s

Modulation: GFSK

Sprachkodierung: 32 kBit / s

Sendeleistung: 10 mW (mittlere Leistung pro Kanal)

Reichweite: bis zu 300 Meter im Freien, in Gebäuden bis zu 50 Metern

Stromversorgung Basisstation:

100–240 V AC (Steckernetzgerät S002CV0600030), 6 V DC / 300 mA

Stromversorgung Ladestation:

100–240 V AC (Steckernetzgerät S002CV0600030), 6 V DC / 300 mA

Betriebsdauer Mobilteil: in Bereitschaft / im Gespräch

500 mAh = ca. 100 h / ca. 10 h

Ladezeit der Akkus: ca. 16 Stunden

Zulässige Umgebungsbedingungen für den Betrieb des Mobilteils:

5°C bis 45°C ; 20 % bis 75 % relative Luftfeuchtigkeit

Zulässige Umgebungsbedingungen für den Betrieb der Basisstation:

5°C bis 45°C ; 20 % bis 75 % relative Luftfeuchtigkeit

Zulässige Lagertemperatur: -10°C bis +60°C

Wahlverfahren: MFV / IWW

R-Taste: Flash (100 ms/300 ms/600 ms)

Abmessungen Basisstation (mm): L / B / H = 110 x 100 x 95

Abmessungen Mobilteil (mm): L / B / H = 46 x 28 x 153

Telefon-Anschluss-Schnur Belegung:

TSV auf Pin 3 und 4 gemäß CTR 37 (Euro-Belegung)

Steckernetzgerät: Eurostecker

Konformitätserklärung



Dieses Gerät erfüllt die Anforderungen der EU-Richtlinien:

- 1999/5/EG Richtlinie über Funkanlagen und Telekommunikationsend-einrichtungen und die gegenseitige Anerkennung ihrer Konformität.
- 2005/32/EG Richtlinie „Energiebetriebene Produkte“.
- Verordnung 1275/2008 „Stromverbrauch im Bereitschafts- und im Auszustand“.
- Verordnung 278/2009 „Netzteile bei Nulllast sowie ihre durchschnittliche Effizienz im Betrieb“.

Die Konformität mit den o. a. Richtlinien wird durch das CE-Zeichen auf dem Gerät bestätigt.

Für die komplette Konformitätserklärung nutzen Sie bitte den kostenlosen Download von unserer Website www.switel.com.

Pflegehinweise

Reinigen Sie die Gehäuseoberflächen mit einem weichen und fusselreichen Tuch. Verwenden Sie keine Reinigungs- oder Lösungsmittel.

Garantie

SWITEL-Geräte werden nach den modernsten Produktionsverfahren hergestellt und geprüft. Ausgesuchte Materialien und hoch entwickelte Technologien sorgen für einwandfreie Funktion und lange Lebensdauer.

Ein Garantiefall liegt nicht vor, wenn die Ursache einer Fehlfunktion des Gerätes bei dem Telefonnetzbetreiber oder einer eventuell zwischengeschalteten Nebenstellenanlage liegt. Die Garantie gilt nicht für die in den Produkten verwendeten Batterien, Akkus oder Akkupacks.

Die Garantiezeit beträgt 24 Monate, gerechnet vom Tage des Kaufs.

Innerhalb der Garantiezeit werden alle Mängel, die auf Material- oder Herstellungsfehler zurückzuführen sind, kostenlos beseitigt. Der Garantieanspruch erlischt bei Eingriffen durch den Käufer oder durch Dritte. Schäden, die durch unsachgemäße Behandlung oder Bedienung, natürliche Abnutzung, durch fal-

sches Aufstellen oder Aufbewahren, durch unsachgemäßen Anschluss oder Installation sowie durch höhere Gewalt oder sonstige äußere Einflüsse entstehen, fallen nicht unter die Garantieleistung.

Wir behalten uns vor, bei Reklamationen die defekten Teile auszubessern, zu ersetzen oder das Gerät auszutauschen. Ausgetauschte Teile oder ausgetauschte Geräte gehen in unser Eigentum über.

Schadenersatzansprüche sind ausgeschlossen, soweit sie nicht auf Vorsatz oder grober Fahrlässigkeit des Herstellers beruhen.

Sollte Ihr Gerät dennoch einen Defekt innerhalb der Garantiezeit aufweisen, wenden Sie sich bitte unter Vorlage Ihrer Kaufquittung ausschließlich an das Geschäft, in dem Sie Ihr SWITEL-Gerät gekauft haben. Alle Gewährleistungsansprüche nach diesen Bestimmungen sind ausschließlich gegenüber Ihrem Fachhändler geltend zu machen. Nach Ablauf von zwei Jahren nach Kauf und Übergabe unserer Produkte können Gewährleistungsrechte nicht mehr geltend gemacht werden.

Stichwortverzeichnis

A

Akkus	2
Akkus aufladen	6
Akkus einlegen	6
Anruf annehmen	13
Anrufen	13
Anrufliste	14, 18
Aufstellungsort	2
Auslieferungszustand	29
Automatische Rufannahme	6, 23

B

Basisstation anschließen	5
Bereitschaftsmodus	11
Bestimmungsgemäße Verwendung	2

D

Datum/Uhrzeit	6, 21
Direktannahme	6
Displayanzeige	23
Displaysprache	6, 22

E

ECO-Mode	11
Entsorgung	3
Externes Gespräch vermitteln	16

F

Fehlersuche	28
Flashzeit	24

G

Garantie	31
Gespräch beenden	13
Gesprächsdauer	15

H

Hinweistöne	22
-------------	----

I

Intern telefonieren	15
---------------------	----

K

Konferenz	16
Konformitätserklärung	31

L

Ladestation	5
Leistungsaufnahme	4

M

Medizinische Geräte	3
Menüstruktur	27
Mikrofon ausschalten	15
Mobilteil ausschalten	17
Mobilteile an-/abmelden	25
Mobilteilnamen	23
Mute	15

N

Navigation im Menü	11
Netzteil	2

Anhang

P

Pflegehinweise31

PIN24

S

Sicherheitshinweise2

Strahlungsreduzierung11

Stromausfall2

Stromverbrauch4

Symbole im Display9

T

Tastensperre17

Technische Daten30

Telefonanlagen26

Telefonbuch14, 19

Tonruf22

Tonruf am Mobilteil ausschalten17

V

Verpackungsinhalt4

W

Wahlverfahren23

Wahlwiederholung14, 18

Wecker21

Werkseinstellungen29

Z

Zurücksetzen24

Zusatzdienste26

1	Consignes de sécurité	2
2	Mettre votre téléphone en service	4
3	Éléments de manipulation	7
4	Introduction	9
5	Téléphoner	13
6	Fonctions spéciales	17
7	Liste d'appels / Répétition des derniers numéros	18
8	Répertoire	19
9	Réglage du téléphone	21
11	Déclarer/retirer un combiné	25
11	Installations à postes supplém. / services confort	26
12	Annexe	27

1 Consignes de sécurité

Lisez très attentivement ce mode d'emploi.

Utilisation conforme aux prescriptions

Ce téléphone convient pour téléphoner à l'intérieur d'un réseau téléphonique.

Tout autre utilisation est considérée comme non conforme à l'usage.

Des modifications ou changements effectués d'un propre gré ne sont pas autorisés. N'ouvrez en aucun cas l'appareil et n'effectuez aucun essai de réparation vous-même.

Lieu d'installation

Évitez toute nuisance par la fumée, la poussière, les vibrations, les produits chimiques, l'humidité, la grande chaleur ou l'ensoleillement direct.

Ne vous servez pas du combiné dans des endroits exposés aux explosions.

Bloc secteur

 **Attention:** N'utilisez que le bloc secteur fourni avec l'appareil, d'autres pouvant endommager votre téléphone. Vous ne devez pas bloquer l'accès au bloc secteur par des meubles ou d'autres objets.

Piles rechargeables

 **Attention:** Ne jetez pas les piles rechargeables dans le feu. N'utilisez que des piles rechargeables du même type ! Veillez à une polarisation correcte ! Risque d'explosion lors de leur chargement si la polarisation est incorrecte.

Panne de courant

En cas de panne de courant, vous ne pouvez pas téléphoner avec le téléphone.

Tenez à votre disposition, pour parer à de telles situations, un téléphone filaire fonctionnant sans alimentation externe en courant.

Appareils médicaux

 **Attention:** N'utilisez pas ce téléphone à proximité d'appareils médicaux. Leur influence ne peut pas être entièrement exclue.

Les téléphones **DECT**¹ peuvent causer un bourdonnement désagréable dans les prothèses auditives.

Élimination

Si vous ne voulez plus vous servir de votre appareil, veuillez l'apporter au centre de collecte de l'organisme d'élimination des déchets de votre commune (par ex. centre de recyclage).

L'icône ci-contre signifie que vous ne devez en aucun cas jeter votre appareil dans les ordures ménagères ! D'après la loi relative aux **appareils électriques et électroniques**, les propriétaires d'appareils usagés sont tenus de mettre tous les appareils électriques et électroniques usagés dans un collecteur séparé.

Éliminez les piles rechargeables auprès d'un revendeur de piles ainsi que dans des centres de collecte compétents qui tiennent à votre disposition les collecteurs appropriés correspondants.

Éliminez les **fournitures d'emballage** conformément au règlement local.



¹ DECT: **D**igital **E**nhanced **C**ordless **T**elecommunication = Standard pour les téléphones sans fil.

2 Mettre votre téléphone en service

Remarques concernant la sécurité

 **Attention:** Avant de mettre votre appareil en service, lisez impérativement les consignes de sécurité mentionnées au chapitre 1.

Contrôler le contenu de l'emballage

Les éléments suivants font partie de la livraison :

Contenu	Modèle DE 27x			
	271 ¹	272 ¹	273 ¹	274 ¹
Base avec bloc d'alimentation	1	1	1	1
Chargeur avec bloc d'alimentation	-	1	2	3
Combiné	1	2	3	4
Câble de raccordement				
téléphonique	1	1	1	1
Piles rechargeables	2	4	6	8
Mode d'emploi	1	1	1	1

¹ À l'adresse www.switel.com, vous apprendrez si ce kit téléphonique est déjà disponible à la vente.

Puissance absorbée

Puissance absorbée de la station de base :

- en mode de fonctionnement (disponible/conversation) : env. 1,2 W
- pendant le chargement du combiné : env. 2 W.

Sans charge, le courant d'alimentation à découpage entrant s'élève à env. 0,15 W. Le rendement moyen est d'env. 60 %.

Puissance absorbée de la station de chargement :

- sans le combiné : env. 0,15 W
- pendant le chargement du combiné : env. 1,2 W.

Sans charge, le courant d'alimentation à découpage entrant s'élève à env. 0,15 W. Le rendement moyen est d'env. 60 %.

Raccorder la base

⚠ Attention: Posez la base à une distance minimum d'1 m par rapport à d'autres appareils électroniques, une distance inférieure pouvant provoquer des interactions.

Raccordez la base comme représenté sur le croquis. Pour des raisons de sécurité, n'utilisez que le bloc d'alimentation fourni avec l'appareil ainsi que le câble de raccordement téléphonique ci-joint.

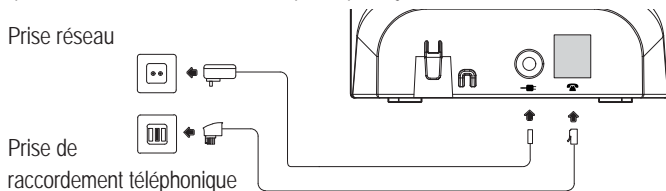

⚠ Attention: N'utilisez pour la base que le bloc d'alimentation fourni S002CV0600030 / 6 V, 300 mA DC avec l'appareil !

Raccorder le chargeur²

Raccordez le chargeur comme représenté sur le croquis. Pour des raisons de sécurité, n'utilisez que le bloc d'alimentation fourni avec l'appareil.

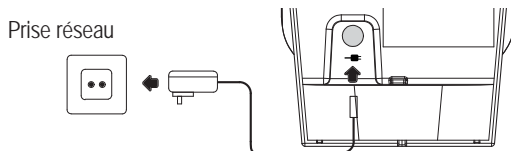

⚠ Attention: N'utilisez pour le chargeur que le bloc d'alimentation S002CV0600030 / 6 V, 300 mA DC fourni avec l'appareil !

² N'est valable que pour les kits téléphoniques avec au moins deux combinés, -> "Contrôler le contenu de l'emballage".

Mettre votre téléphone en service

Mettre en place les piles rechargeables

Ouvrez le compartiment à piles. Introduisez les piles dans le compartiment prévu à cet effet. Fermez le compartiment à piles.

⚠ Attention: N'utilisez que des piles rechargeables de type AAA Ni-MH 1,2 V. Observez une polarisation correcte ! Ne jamais utiliser de piles ou piles primaires !

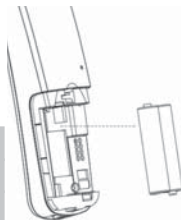

Recharger les piles rechargeables

☞ Pour la première mise en service, posez le combiné sur la base / le chargeur pour une durée d'au moins 16 heures.

Le combiné chauffe lors du chargement. C'est normal et ce n'est pas dangereux. Ne chargez pas le combiné avec des chargeurs d'un autre fabricant. L'état de charge des piles rechargeables est indiqué sur l'écran. Lorsque le chargement des piles rechargeables a atteint la limite inférieure, le symbole de la pile (☐) clignote sur l'écran et vous entendez l'alerte sonore des piles (si l'alerte sonore des piles est activée/via le menu "REGL. COMB./ALERTE SON./BATT.FAIBLE"). Vous avez encore un temps de communication d'env. 10 minutes.

Réglage de la date et de l'heure

Lors de la mise en service, le combiné n'est pas réglé à l'heure correcte (p. ex. pour les entrées de la liste d'appels). Vous réglez la date et l'heure via le menu „REGL. COMB./DATE & HEURE”.

Paramétrer la langue de l'écran

La langue de l'écran est réglable en 13 langues différentes. Dans son état à la livraison, elle est réglée sur „allemand”. Vous pouvez changer la langue via le menu „MT-EINSEL./SPRACHE”.

Prise d'appel automatique / Réponse autom.

Si vous avez activé la fonction, l'appel sera automatiquement réceptionné quand vous prendrez le combiné de la base. La prise d'appel automatique s'active ou se désactive via le menu „REGL. COMB./REPONSE AUTO”.

3 Éléments de manipulation

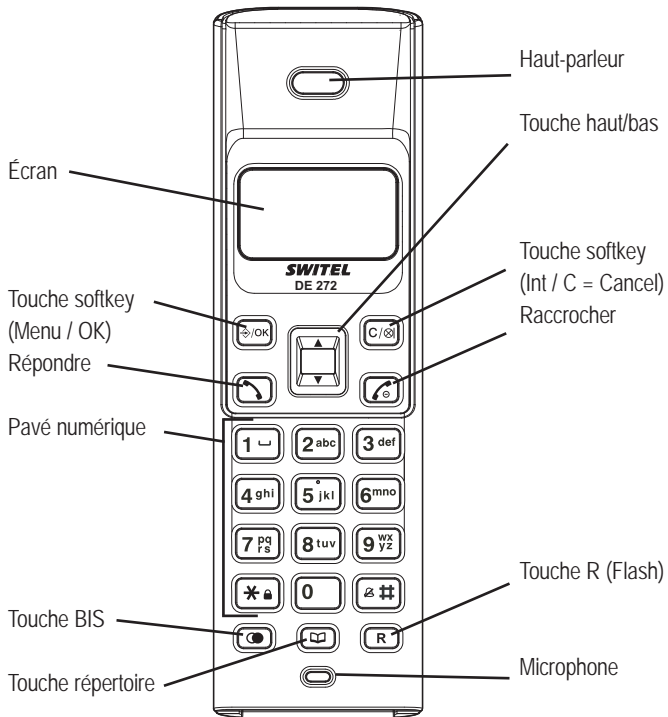

Éléments de manipulation

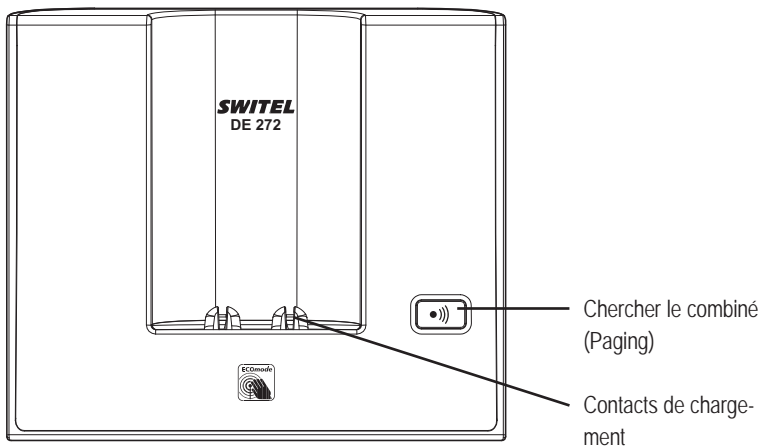







4 Introduction

Dans ce chapitre, vous trouverez des informations de base vous expliquant comment vous servir du mode d'emploi et du téléphone.

Mode de représentation dans le mode d'emploi

Visualisation	Description
	Visualisation des touches
	Appuyer sur la touche représentée
	Saisir des chiffres ou des lettres
	Le combiné sonne
	Prendre le combiné de la base
	Poser le combiné sur la base
NAME?	Visualisation des textes de l'écran
	Visualisation des icônes de l'écran

Icônes à l'écran du combiné

Icône	Description
	Constant : la liaison avec la base est bonne. Clignotant : la liaison avec la base s'interrompt.
	Constant : affichage de la capacité des piles. Clignotant quand le combiné est sur la base : Les piles rechargeables se rechargent.
	Constant : les piles rechargeables devraient être chargées. Clignotant : chargez les piles rechargeables.
	Constant : Vous téléphonez. Clignotant : Le téléphone sonne.
	La sonnerie d'appel est désactivée.
	Constant : la fonction d'alarme est activée. Clignotant : alarme.
	Le verrouillage du clavier est activé.

Introduction



Vous avez un message dans la boîte vocale de votre exploitant de réseau (selon l'exploitant de réseau)



Constant : vous tenez une communication interne (uniquement si base avec plusieurs combinés).

Clignotant : réception d'un message interne.



Quand affichage de la liste d'appels: nouvel appel



Autres chiffres/lettres affichées avant ou après les actuelles. Pour les afficher, appuyez sur la touche softkey correspondante.

Dans les lignes de l'écran ci-dessous sont indiquées les fonctions disponibles liées aux deux **touches softkeys** dépendamment de l'état de fonctionnement.



Appel du menu.



Confirmation d'un réglage.



Tenir un appel interne (uniquement si base avec plusieurs combinés).



Retour au menu supérieur ou interruption de la programmation.



Effacer à reculons les signes de l'entrée

(une pression courte efface le dernier signe, une pression longue efface la ligne entière),

Activer/désactiver le microphone pendant une communication (muet).

Mode veille

Toutes les descriptions dans ce mode d'emploi partent du principe que le combiné se trouve en mode veille. Vous parviendrez au mode veille en appuyant sur la touche .

Réduction du rayonnement (mode ÉCO)





En comparaison avec les téléphones sans fil DECT standard, le rayonnement est considérablement réduit en mode de communication.

Navigation dans le menu

Vous pouvez accéder à toutes les fonctions via différents menus. Vous trouvez la structure complète du menu dans l'annexe.

Pour naviguer dans le menu, utilisez les touches softkeys et fléchées.

Avec touche softkey gauche , vous ouvrez le menu.

Avec les touches fléchées  ou , vous naviguez dans le menu.

Pour ouvrir un sous-menu, appuyez sur la touche softkey .

Si vous voulez revenir au menu supérieur, appuyez brièvement sur . Par pression longue, vous retournez en mode veille.

Créer des enregistrements dans le répertoire - exemple

L'exemple Créer des enregistrements dans le répertoire vous explique comment naviguer dans les menus et saisir des données. Pour tous les réglages, procédez comme dans cet exemple.



Ouvrir le répertoire

ou



Appuyer touche softkey **Menu**.



OK

Sélectionner **REPertoire** et confirmer sur **OK**.

S'il n'y a encore aucune entrée, **VIDE** s'affiche.

S'il y a déjà des entrées, la première entrée est affichée.



Appuyez touche softkey **Menu**.

OK

Confirmez **Ajouter** avec **OK**.



Indiquez le nom (12 signes maximum).

Les touches de chiffres comportent des lettres.

Lettres et chiffres peuvent être entrés par pressions répétées de la touche correspondante.

Après peu de temps, le curseur se déplace vers la droite.

OK

Terminez l'entrée du nom avec **OK**.



Entrez le numéro de téléphone (20 chiffres maximum).

OK

Terminez l'entrée du numéro de téléphone avec **OK**.



Sélectionnez une mélodie pour l'entrée.

OK

Confirmez avec **OK**.



Retour au mode veille.

5 Téléphoner

Prendre l'appel



Votre téléphone sonne.

Si le combiné **ne** se trouve pas sur la base:



Appuyez sur la touche décrocher.

Si le combiné se trouve sur la base et **REPONSE AUTO n'est** pas activé:



Prenez le combiné de la base et appuyez sur la touche décrocher.

Si le combiné se trouve sur la base et **REPONSE AUTO** est activé:



Prenez simplement le combiné de la base ; la communication est réceptionnée automatiquement.

Appeler



Entrez le numéro de téléphone.

Corrigez une erreur d'entrée avec .



Le numéro de téléphone est composé.



 Vous pouvez aussi appuyer d'abord sur la touche communication et vous obtenez ainsi la tonalité. Les chiffres entrés du numéro de téléphone choisi sont aussitôt composés. Il n'est pas possible de corriger les chiffres du numéro de de téléphone dans cette forme de mise en communication.

Terminer la communication



Appuyer sur la touche décrocher ou poser le combiné sur la base.

Répétition des derniers numéros

 Votre téléphone mémorise les cinq derniers numéros de téléphone composés. Si le numéro de téléphone est mémorisé dans le répertoire, le nom s'affiche. Pour afficher le numéro de téléphone correspondant, appuyez sur la touche dièse . Le dernier numéro de téléphone composé se trouve toujours en tête de liste.



Ouvrir la liste de répétition des derniers numéros.





Sélectionner l'enregistrement.



Le numéro est composé.

Appeler depuis la liste d'appels

 Votre téléphone mémorise les 10 derniers appels dans la liste d'appels. Si le numéro de téléphone est mémorisé dans le répertoire, le nom s'affiche. Pour afficher le numéro de téléphone correspondant, appuyez sur la touche dièse . L'enregistrement ne peut avoir lieu que si la fonction „transfert d'appel (CLIP)“ est disponible sur votre raccordement et le numéro de l'appelant n'a pas été retenu ou rendu non transmissible pour d'autres raisons.



Ouvrir la liste d'appels.



Sélectionner l'enregistrement.



Le numéro est composé.

Appeler depuis le répertoire

 Le répertoire peut recevoir 20 entrées. Pour mémoriser des entrées voir le paragraphe „Répertoire“.



Ouvrir le répertoire.



Sélectionner l'enregistrement.



Le numéro est composé.

Affichage de la durée de la communication

Pendant une communication, sa durée est affichée en heures, minutes et secondes.

Régler le volume sonore de l'écouteur



Vous disposez de 5 niveaux pour régler le volume pendant une communication. La réglage est restent mémorisés même après fin de la communication.

Débranchement du microphone du combiné



Vous pouvez désactiver le microphone pendant une communication afin que votre interlocuteur ne puisse pas vous déranger. **MUET** s'affiche sur l'écran.



Pour activer le microphone, appuyez de nouveau sur la touche.

Téléphoner en interne

 Communication internes, transferts et communications en conférence sont possibles uniquement si plusieurs combinés sont déclarés. Si ce n'est pas le cas, **PAS POSS.** s'affichera sur l'écran.

Téléphoner en interne



Appuyez la touche softkey **Intercom**. Si deux combinés sont déclarés, l'autre combiné est aussitôt appelé. Dans le cas de plusieurs combinés déclarés, leurs numéros internes s'affichent (p. ex. 2 3 4). Appuyez sur le numéro interne souhaité. Si vous appuyez sur „9" dans le cas de plusieurs combinés déclarés, tous sont appelés simultanément.

Transfert d'une communication externe



Pendant une communication externe. . .

Appuyez la touche softkey **Menu**.

Sélectionnez **INTERN** et appuyez sur **OK**.

Entrez le numéro interne. La communication externe est maintenue.

Si le combiné appelé est activé, annoncer la communication le cas échéant

Appuyez sur la touche raccrocher. La communication est transmise.

Conférence



Pendant une communication externe. . .

Appuyez la touche softkey **Menu**.

Sélectionnez **INTERN** et appuyez sur **OK**.

Entrez le numéro interne.

Quand le combiné appelé est activé, appuyez et maintenez la touche étoile jusqu'à ce que **CONFERENCE** apparaisse sur l'écran.

 i l'un des participants à la conférence raccroche, les deux autres restent en communication.

6 Fonctions spéciales

Verrouillage du clavier

 La touche verrouillage empêche une manipulation involontaire des touches. Les appels peuvent être reçus comme d'habitude.



Appuyez et maintenez la touche étoile jusqu'à l'apparition du symbole de verrouillage des touches.



Pour déverrouiller le clavier, appuyez et maintenez de nouveau la touche étoile jusqu'à la disparition du symbole.

Désactiver la sonnerie du combiné

 Vous pouvez désactiver la sonnerie d'appel aussi via le menu „REGL.COMB./SONNERIE“.



Appuyez et maintenez la touche dièse jusqu'à l'apparition du symbole de désactivation de la sonnerie d'appel .



Pour réactiver la sonnerie d'appel, appuyez et maintenez de nouveau la touche dièse jusqu'à disparition du symbole.

Désactiver le combiné

 Vous pouvez désactiver le combiné pour économiser les piles rechargeables.



Appuyez sur raccrocher et maintenez la touche appuyée. Après quelques secondes, le combiné est désactivé. L'éclairage de l'écran s'éteint.



Pour réactiver le combiné, appuyez sur la touche raccrocher jusqu'à ce que vous entendiez le signal sonore et que l'écran s'éclaire de nouveau.

7 Liste d'appels / Répétition des derniers numéros

Utiliser la liste d'appels



Ouvrez la liste d'appels.



Sélectionnez une entrée.



Appuyez sur touche softkey **Menu**.



Sélectionnez l'une des options suivantes et confirmez avec **OK**:

AJOUTER

Le numéro est enregistré dans le répertoire. Entrez le nom, confirmez ou modifiez le numéro et fixez une mélodie sonore pour cette entrée.

SUPPRIMER

L'entrée est effacée.

SUPPRIM.TOUT

La liste complète est effacée après une question de sécurité.

DETAILS

Date et heure de l'appel sont affichées.



Vous pouvez ouvrir la liste d'appels aussi via le menu:



JOURNAL **OK**

Utiliser la répétition des derniers numéros



Ouvrir la répétition des derniers numéros.



Sélectionnez une entrée.



Appuyez sur touche softkey **Menu**.



Sélectionnez l'une des options suivantes et confirmez avec **OK**:

AJOUTER

Le numéro est enregistré dans le répertoire. Entrez le nom, confirmez ou modifiez le numéro et fixez une mélodie sonore pour cette entrée.

SUPPRIMER

L'entrée est effacée.

SUPPRIM.TOUT

La liste complète est effacée après une question de sécurité.

8 Répertoire

 Dans le répertoire, vous pouvez mémoriser 20 numéros et noms correspondants. Vous pouvez associer à chaque entrée une mélodie propre par laquelle un appel doit être signalé. Entrez toujours les numéros avec le préfixe ; ceci permet un affichage correct de chaque appelant dont il existe une entrée et dont le transfert de numéro à votre raccordement est disponible.

Saisir une nouvelle entrée



Appuyez sur la touche répertoire.

S'il n'y a encore aucune entrée, **VIDE** s'affiche.

S'il y a déjà des entrées, la première entrée est affichée.



Appuyez touche softkey **Menu**.



Confirmez **AJOUTER** avec **OK**.



Entrez le nom (12 signes maximum).

Les touches de chiffres comportent des lettres.

Lettres et chiffres peuvent être entrés par pressions répétées de la touche correspondante.

Après peu de temps, le curseur se déplace vers la droite.

Terminez l'entrée du nom avec **OK**.



Entrez le numéro (20 chiffres maximum). Si votre téléphone est raccordé à une installation téléphonique, entrez aussi le code d'identification. Si une pause est nécessaire, après le code d'identification, appuyez sur la touche **0** pendant env. 2 s ; **P** s'affiche sur l'écran.



Terminez l'entrée du numéro avec **OK**.



Sélectionnez une mélodie pour l'entrée.



Confirmez avec **OK**.



Retour au mode veille.



 Vous pouvez ouvrir le répertoire aussi via le menu.



Utiliser les entrées du répertoire



Appuyez la touche répertoire.



Sélectionnez une entrée.



Appuyez la touche softkey **Menu**.



Sélectionnez parmi les options suivantes et confirmez avec **OK**:

AJOUTER

Vous pouvez effectuer une nouvelle entrée.

EDITER

L'entrée est affichée. Avec les touches fléchées, vous pouvez voir nom, numéro et mélodie.

MODIFIER

Vous pouvez modifier l'entrée. Effacez les lettres et chiffres avec **C**, entrez de nouvelles lettres et chiffres avec les touches de chiffres. Pour plus de détails, voir „insérer nouvelle entrée“.

SUPPRIMER

L'entrée est effacée.

SUPPRIM.TOUT

La liste complète est effacée après une question de sécurité.

ETAT REPERT.

La configuration actuelle est affichée (p. ex. **07/20 CREEES**: 7 sur 20 entrées possibles sont existantes).

9 Réglage du téléphone

Date/heure



Appuyez touche softkey **Menu**.



Sélectionnez **REGL. COMB** et appuyer sur **OK**.



Sélectionnez **DATE & HEURE** et appuyer sur **OK**.



Choisissez parmi les options suivantes et confirmez avec **OK**:

FORMAT DATE Vous pouvez régler la représentation de la date :
(JJ-MM-AA ou MM-JJ-AA).

FORMAT HEURE Vous pouvez régler la représentation de l'heure:
(24 heures ou 12 heures).

REGLER HEURE Entrez l'heure avec les touches de chiffres.

REGLER DATE Entrez la date avec les touches de chiffres.

En cas de panne de courant, le réglage est perdu si le combiné est désactivé en même temps ou les piles rechargeables sont vides.

Réveil



Appuyez touche softkey **Menu**.



Sélectionnez **REGL. COMB** et appuyer sur **OK**.



Sélectionnez **ALARME** et appuyez sur **OK**.



Sélectionnez **ON** et appuyez sur **OK**.



Entrez l'heure de réveil avec les touches de chiffres.

SNOOZE Appuyez sur **OK**.



Sélectionnez **ON** ou **OFF** et appuyez sur **OK**.

Si „Snooze“ est activé, cela signifie que le signal de réveil sera répété après 7 minutes, jusqu'à ce que cette fonction soit arrêté par pression et maintien de la touche raccrocher.

Si „Snooze“ est désactivé, le signal de réveil retentira une seule fois à l'heure fixée. Pour quitter le signal de réveil, appuyez sur une touche quelconque.

Réglage du téléphone

Régler la sonnerie du combiné



Appuyez touche softkey **Menu**.



Sélectionnez **REGL. COMB** et appuyez sur **OK**.



Sélectionnez **SONNERIE** et appuyez sur **OK**.



Choisissez parmi les options suivantes et confirmez avec **OK** :

SONNERIE INT Sélectionnez une mélodie pour la signalisation d'un appel interne.

SONNERIE EXT Sélectionnez une mélodie pour la signalisation d'un appel externe.

VOL.SONNERIE Sélectionnez le volume de la sonnerie. Sélectionnez „**VOLUME OFF**“, le symbole s'affiche sur l'écran.

Régler la tonalités d'information



Appuyez touche softkey **Menu**.



Sélectionnez **REGL. COMB** et appuyez sur **OK**.



Sélectionnez **ALERTES SON.** et appuyez sur **OK**.



Choisissez parmi les options suivantes et confirmez avec **OK** :

BIPS TOUCHES Activez ou désactivez la tonalité de confirmation pour l'activation d'une touche.

BATT.FAIBLE Activez ou désactivez la tonalité d'information spéciale. La tonalité signale quand les piles rechargeables doivent être chargées.

HORS PORTEE Activez ou désactivez la tonalité d'information spéciale. La tonalité signale quand vous vous trouvez avec le combiné à la limite de portée de la base.

Régler la langue de l'écran



Appuyez touche softkey **Menu**.



Sélectionnez **REGL. COMB** et appuyez sur **OK**.



Sélectionnez **LANGUE** et appuyez sur **OK**.



Sélectionnez une langue et confirmez avec **OK**.

Régler le nom du combiné



Appuyez touche softkey **Menu**.



Sélectionnez **REGL. COMB** et appuyer sur **OK**.



Sélectionnez **RENOMMER CB** et appuyez sur **OK**.



Effacez l'ancien nom avec **C**, entrez le nouveau nom avec les touches de chiffres et appuyez sur **OK**.

Régler l'affichage de l'écran



Appuyez touche softkey **Menu**.



Sélectionnez **REGL. COMB** et appuyer sur **OK**.



Sélectionnez **AFFICHAGE** et appuyez sur **OK**.



Choisissez si, en mode veille, le nom du combiné ou l'heure doivent être affichés et confirmez avec **OK**.

Régler la réponse d'appel automatique



Appuyez touche softkey **Menu**.



Sélectionnez **REGL. COMB** et appuyer sur **OK**.



Sélectionnez **REPONSE AUTO** et appuyez sur **OK**.



Choisissez si la réponse automatique doit être activée ou dés-activée et confirmez avec **OK**.

Lorsque la réponse automatique est activée, un appel est aussitôt réceptionné quand le combiné est pris de la base.

Régler le processus de numérotation



Appuyez touche softkey **Menu**.



Sélectionnez **REGL. BASE** et appuyer sur **OK**.



Sélectionnez **NUMEROTATION** et appuyez sur **OK**.



Sélectionnez **FREQ. VOCALE** ou **DECIMALE** et confirmez avec **OK**.

Pour la plupart des raccords, le réglage correct est **FREQ. VOCALE**.

Réglage du téléphone

Réglez le temps de flash



Appuyez touche softkey **Menu**.



Sélectionnez **REGL. BASE** et appuyer sur **OK**.



Sélectionnez **DELAI R** et appuyez sur **OK**.



Sélectionnez COURT (100 ms), MEDIUM (300 ms) ou LONG (600 ms) et confirmez avec **OK**.

Modifier le PIN



Appuyez touche softkey **Menu**.



Sélectionnez **REGL. BASE** et appuyer sur **OK**.



Sélectionnez **MODIFIER PIN** et appuyez sur **OK**.



Entrez le PIN actuel

(Etat à la livraison : 0 0 0 0) et appuyez sur **OK**.



Entrez un nouveau PIN et appuyez sur **OK**.



Entrez le nouveau PIN une nouvelle fois et appuyez sur **OK**.

Le PIN à quatre chiffres protège quelques réglages contre un accès non autorisé. Si vous avez oublié le PIN, merci de vous adresser à notre service hotline.

Remettre le téléphone comme à l'état de livraison



Appuyez touche softkey **Menu**.



Sélectionnez **DEFAUT** et appuyez sur **OK**.



Entrez le PIN actuel et appuyez sur **OK**.

Confirmez aussi la question de sécurité suivante avec **OK**.

Le répertoire n'est pas effacé. Veuillez effacer le répertoire via le menu du répertoire.

Les combinés déclarés restent déclarés.

11 Déclarer/retirer un combiné

Sur une base, vous pouvez déclarer jusqu'à 5 combinés. Les combinés livrés avec votre téléphone sont déjà déclarés sur la base. Pour déclarer un combiné „étranger“, consultez aussi la notice d'utilisation de ce combiné.

Déclarer un autre combiné du même type



Appuyez touche softkey **Menu**.



Sélectionnez **ASSOCIATION** et appuyez sur **OK**.



Entrez le PIN actuel de la base sur laquelle le combiné doit être déclaré et appuyez sur **OK**.



Appuyez et maintenez la touche Paging sur la base jusqu'à ce que la tonalité d'activation soit audible (env. 5 s).

Peu de temps après, le symbole de l'antenne est éclairé, constant, sur l'écran et le combiné est déclaré.

Retirer le combiné



Appuyez touche softkey **Menu**.



Sélectionnez **REGL. BASE** et appuyez sur **OK**.



Sélectionnez **ANNULER COMB** et appuyez sur **OK**.



Entrez le PIN actuel et appuyez sur **OK**.



Sélectionnez l'un des combinés indiqués et appuyez sur **OK**.

Le combiné que vous utilisez en ce moment ne peut pas être annulé.

11 Installations à postes supplém. / services confort

Installations à postes supplémentaires

Si votre téléphone est raccordé à une installation à postes supplémentaires, vous pouvez au moyen de la touche R tirer profit de certaines fonctions comme par ex. le transfert d'appels et le rappel automatique. Veuillez lire le mode d'emploi de votre installation à postes supplémentaires pour connaître le temps de flash à paramétrer pour tirer profit de ces fonctions.

Votre revendeur, auprès duquel vous avez acheté l'installation, vous informera si votre téléphone fonctionne impeccablement sur ce genre d'installation.

Merci de penser le cas échéant, pour les entrées dans le répertoire, au code d'identification et à la pause parfois nécessaire lui succédant (appuyer longuement sur le chiffre „0“).

Services confort

Votre téléphone supporte les services confort de votre opérateur, comme par ex. le va-et-vient, la signalisation d'appel en instance et la conférence.

Via la touche R vous pouvez tirer profit de ces services confort. Veuillez demander à votre opérateur quel temps de flash vous devez paramétrer pour tirer profit des services confort. Adressez-vous également à lui pour la déconnexion de ces services.

12 Annexe

Structure du menu

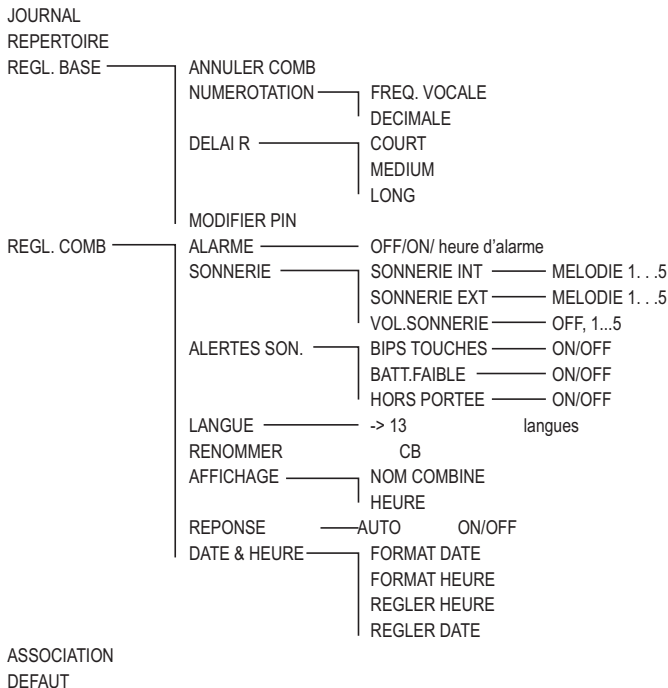

Recherche erronée

Si vous avez des problèmes avec votre téléphone, contrôlez d'abord les indications suivantes. En cas de problèmes techniques, vous pouvez vous adresser à notre hotline de service en appelant le numéro 0900 00 1675 en Suisse (frais Swisscom à la date d'impression de ce manuel : CHF 2.00/min). Si vous jouissez des droits de garantie, adressez-vous à votre revendeur. La durée de la garantie est de 2 ans.

- Après activation de la touche décrocher, aucune tonalité n'est audible, la ligne d'appel n'est pas occupée.
 - Contrôler la fiche du raccordement téléphonique de la base et de la prise de téléphone.
 - Contrôler la prise réseau à la base et les 230 V.
 - La ligne d'appel est occupée par un autre combiné. Patientez jusqu'à ce que la liaison soit terminée.
- Affichage de l'écran : „CHERCHE”.
 - Contrôler la prise réseau à la base et les 230 V.
 - Réduire distance.
 - Déclarer combiné.
- Aucun affichage sur l'écran.
 - Combiné désactivé -> activer.
 - Pile vide -> recharger.

Configuration d'origine/Etat à la livraison

Liste d'appels	Vide
Repertoire	Vide
Alarme	OFF
Sonnerie combine	Interne Melodie 1 Externe Melodie 2 Vol. sonnerie 5
Alertes son.	Bips touches: Activer Accu faible: Activer Hors portée: Activer
Langue	Allemand
Nom combine	DE 27x
Displayanzeige	Nom combine
Reponse auto	ON
Date & Heure	Format date: JJ-MM-AA Format heure: 24 heures
Mode de numerotation	Tonalité
Temps Flash	Court (100 ms)
PIN	0 0 0 0

Caractéristiques techniques

Standard : DECT / GAP

Nombre de canaux : 120 canaux duplex

Fréquences : 1880 MHz jusqu'à 1900 MHz

Processus duplex : multiplexage par répartition dans le temps (MRT),
10ms longueur de marge

Trame canaux : 1728 kHz

Débit binaire : 1152 kbits / s

Modulation : GFSK

Codage langue : 32 kbits / s

Puissance d'émission : 10 mW (puissance moyenne par canal)

Portée: jusqu'à 300 mètres en champ libre,
 jusqu'à 50 mètres à l'intérieur d'un bâtiment

Alimentation en courant de la base :

100-240 V AC (bloc d'alimentation S002CV0600030), 6 V DC / 300 mA

Alimentation de courant chargeur :

100-240 V AC (bloc d'alimentation S002CV0600030), 6 V DC / 300 mA

Durée de service combiné : en veille / en communication

500 mAh = env. 100 h / env. 10 h

Temps de charge des piles rechargeables : env. 16 heures

Conditions ambiantes admissibles pour le fonctionnement du combiné :

5°C jusqu'à 45°C ; 20 % jusqu'à 75 % d'humidité relative

Conditions ambiantes admissibles pour le fonctionnement de la base :

5°C jusqu'à 45°C ; 20 % jusqu'à 75 % d'humidité relative

Température de stockage admissible : -10°C jusqu'à +60°C

Processus de numérotation : MFV / IWV

Fonction touche R : Flash (100 ms/300 ms/600 ms)

Dimensions de la base (mm) : Longueur / largeur / hauteur = 110 x 100 x 95

Dimensions du combiné (mm) : Longueur / largeur / hauteur = 46 x 28 x 153

Configuration du câble de raccordement téléphonique :

TSV 3/4 selon CTR 37 (configuration européenne)

Bloc d'alimentation : prise européenne

Déclaration de conformité



Cet appareil répond aux exigences des directives de l'union européenne (UE) :

- 1999/5/CE Directive sur les installations de radio et de télécommunication et la reconnaissance réciproque de leur conformité.
- 2005/32/CE Directive « Produits consommateurs d'énergie ».
- Règlement 1275/2008 « Consommation d'électricité en mode veille et en mode arrêt ».
- Règlement 278/2009 « Sources d'alimentation hors charge et leur rendement moyen en mode actif ».

La conformité avec les directives mentionnées ci-dessus est confirmée sur l'appareil par la marque CE. Pour obtenir toute la déclaration de conformité, veuillez utiliser le téléchargement gratuit de notre site Internet www.switel.com.

Remarques d'entretien

Nettoyez les surfaces du boîtier avec un chiffon doux et non pelucheux.

N'utilisez pas de produits d'entretien ou de solvants.

Garantie

Les appareils SWITEL sont fabriqués selon les procédés les plus modernes et sont contrôlés. Des matériels sélectionnés et des technologies de pointe ont pour effet un fonctionnement irréprochable et une longue durée de vie. La garantie ne rentre pas en jeu si l'exploitant du réseau téléphonique ou une installation à postes supplémentaires éventuellement intercalée est responsable du dysfonctionnement de l'appareil. La garantie n'est pas valable pour les piles, piles rechargeables ou packs de piles utilisés dans le produits. La durée de la garantie est de 24 mois, à partir de la date d'achat.

Pendant la durée de la garantie, tous les défauts, dus à des vices de matériel ou de fabrication, seront éliminés gratuitement. Le droit à la garantie expire en cas d'intervention de l'acheteur ou de tiers. Les dommages provenant d'un manie- ment ou d'une manipulation incorrects, d'une mauvaise mise en place ou d'une mauvaise conservation de l'appareil, d'un raccordement non conforme ainsi que

d'un cas de force majeure ou autres influences extérieures, sont exclus de la garantie.

Nous nous réservons le droit, en cas de réclamations, de réparer ou de remplacer les composants défectueux ou d'échanger l'appareil. Les composants remplacés ou les appareils échangés deviennent notre propriété.

Les demandes de dommages et intérêts sont exclues tant qu'elles ne reposent pas sur l'intention ou une négligence grossière du fabricant.

Si votre appareil devait malgré tout présenter une défectuosité pendant la période de garantie, veuillez vous adresser, muni de la quittance d'achat, exclusivement au magasin où vous avez acheté votre appareil SWITEL. Vous ne pouvez faire valoir vos droits à la garantie selon ces dispositions qu'auprès de votre revendeur exclusivement. Deux ans après l'achat et la remise de nos produits, il n'est plus possible de faire valoir les droits à la garantie.

Index

A

Affichage de l'écran	23
Appareils médicaux	3
Appeler	13

B

Bloc secteur	2
--------------	---

C

Caractéristiques techniques	30
Chargeur	5
Conférence	16
Consignes de sécurité	2
Contenu de l'emballage	4

D

Date/heure	6, 21
Débranchement du microphone	15
Déclaration de conformité	31
Déclarer/retirer un combiné	25
Désactiver la sonnerie du combiné	17
Désactiver le combiné	17
Durée de la communication	15

E

Élimination	3
Etat à la livraison	29

G

Garantie	31
----------	----

I

Icônes	9
--------	---

L

Langue de l'écran	6, 22
Lieu d'installation	2
Liste d'appels	14, 18

M

Mettre en place les piles rechargeables	6
Mode ÉCO	11
Mode veille	11

N

Navigation dans le menu	11
Nom du combiné	23
Numérotation	23

P

Panne de courant	2
Piles rechargeables	2
PIN	24
Postes supplémentaires	26
Prendre l'appel	13
Prise d'appel automatique	6
Puissance absorbée	4

R

Raccorder la base	5
Recharger les piles rechargeables	6
Recherche erronée	28

Annexe

Réduction du rayonnement	11
Régler le volume	15
Remarques d'entretien	31
Remettre le téléphone	24
Répertoire	14, 19
Répétition des derniers numéros 14, 18	
Réponse autom.	6
Réponse d'appel automatique	23
Réveil	21

S

Services confort	26
Sonnerie du combiné	22
Structure du menu	27

T

Téléphoner en interne	15
Temps de flash	24
Terminer la communication	13
Tonalités d'information	22
Transfert d'une communication externe	16

U

Utilisation conforme aux prescriptions 2	
--	--

V

Verrouillage du clavier	17
-----------------------------------	----

1	Indicazioni di sicurezza	2
2	Mettere in funzione il telefono	4
3	Elementi di comando	7
4	Informazioni introduttive	9
5	Compiere telefonate	13
6	Funzioni speciali	17
7	Elenco chiamate/ripetizione di selezione	18
8	Rubrica telefonica	19
9	Impostazioni Telefono	21
10	Registrare/cancellare un'unità portatile	25
11	Impianti telefonici interni / Servizi aggiuntivi	26
12	Appendice	27

1 Indicazioni di sicurezza

Leggere attentamente le presenti istruzioni per l'uso.

Impiego conforme agli usi previsti

Il presente telefono consente di svolgere telefonate all'interno di una rete telefonica. Qualsiasi altro impiego è considerato come non conforme agli usi previsti. Non sono consentite modifiche o trasformazioni non autorizzate. Non aprire per nessuna ragione l'apparecchio autonomamente, né compiere riparazioni di propria iniziativa.

Luogo di installazione

Evitare l'esposizione a fumo, polvere, vibrazioni, sostanze chimiche, umidità, eccessivo calore o irradiazioni solari dirette.

Non utilizzare l'unità portatile in aree esposte al rischio di deflagrazione.

Alimentatore di rete

 **Attenzione:** Utilizzare solo l'alimentatore a spina fornito in dotazione visto che altri alimentatori di rete potrebbero addirittura danneggiare il telefono. Non ostacolare il libero accesso all'alimentatore a spina con mobili o altri oggetti simili.

Accumulatore ricaricabile

 **Attenzione:** Non gettare batterie ricaricabili nel fuoco. Utilizzare solo batterie ricaricabili dello stesso tipo! Osservare la corretta polarità! Pericolo di esplosione durante il caricamento della batteria in caso di errata polarità.

Caduta di tensione

In caso di caduta di tensione non è possibile compiere chiamate con il telefono. Si consiglia di ricorrere in caso di emergenza ad un telefono con filo in grado di funzionare anche senza alimentazione elettrica esterna.

Apparecchiature mediche

 **Attenzione:** Non utilizzare il telefono in prossimità di apparecchiature mediche. Non è possibile escludere il subentro di eventuali interferenze.

Telefoni **DECT**¹ possono causare un fastidioso ronzio in apparecchi acustici.

Smaltimento

Procedere allo smaltimento dell'apparecchio esaurito consegnandolo presso uno dei punti di raccolta istituiti dalla propria società di smaltimento rifiuti comunale (per es. centro di riciclo materiali). Il simbolo riportato qui a lato indica che non è assolutamente consentito smaltire l'apparecchio assieme ai normali rifiuti domestici!



Secondo quanto previsto dalla legge sugli **apparecchi elettrici ed elettronici**, i proprietari di apparecchi esauriti sono per legge tenuti alla consegna di tutti gli apparecchi elettrici ed elettronici presso un centro di rilievo rifiuti in raccolta differenziata.

Consegnare le batterie ricaricabili per lo smaltimento presso rivenditori al dettaglio di batterie o centri di raccolta che mettono a disposizione appositi contenitori.



Smaltire **confezioni ed imballaggi** in base a quanto indicato dalle norme in vigore a livello locale.



¹ DECT: **D**igital **E**nhanced **C**ordless **T**elecommunication = Standard per telefoni senza cavo.

2 Mettere in funzione il telefono

Indicazioni di sicurezza

 **Attenzione:** Prima della messa in funzione, leggere attentamente le indicazioni di sicurezza riportate al capitolo 1.

Verificare il contenuto della confezione

La confezione contiene:

Contenuto	Modello DE 27x			
	271 ¹	272 ¹	273 ¹	274 ¹
Stazione base				
con alimentatore di rete	1	1	1	1
Stazione di carica con				
alimentatore	-	1	2	3
Unità portatile	1	2	3	4
Cavo di collegamento telefonico	1	1	1	1
Accumulatore ricaricabile	2	4	6	8
Istruzioni per l'uso	1	1	1	1

¹ Per ulteriori informazioni riguardo la disponibilità di questo set telefonico si prega di visitare il sito www.switel.com.

Potenza assorbita

La potenza assorbita dalla stazione base ammonta a:

- in servizio (stand-by/conversazione): ca. 1,2 W
- durante la carica dell'unità mobile: ca. 2 W.

Il carico nullo de circuito di alimentazione rete è pari a circa 0,15 W.

L'efficienza media è pari a circa il 60 %.

La potenza assorbita dalla stazione di carica ammonta a:

- senza unità mobile: ca. 0,15 W
- durante la carica dell'unità mobile: ca. 1,2 W.

Il carico nullo de circuito di alimentazione rete è pari a circa 0,15 W.

L'efficienza media è pari a circa il 60 %.

Collegare la stazione base

⚠ Attenzione: Montare la stazione base con una distanza minima di 1 m da altri apparecchi elettronici in modo da evitare interferenze reciproche.

Procedere al collegamento della stazione base seguendo quanto raffigurato nella figura. Utilizzare per motivi di sicurezza solo l'alimentatore di rete oltre che il cavo di collegamento telefonico forniti in dotazione.

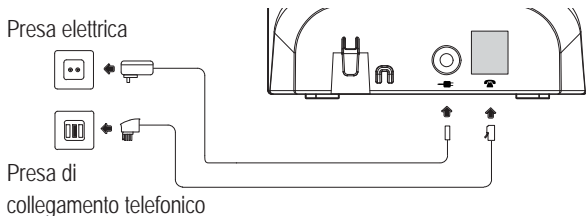

⚠ Attenzione: Utilizzare per la stazione base, solo l'alimentatore fornito in dotazione (S002CV0600030 / 6 V, 300 mA DC)!

Collegare la stazione di carica²

Procedere al collegamento della stazione di carica secondo quanto indicato nella figura. Per motivi di sicurezza si prega di utilizzare soltanto l'alimentatore di rete fornito in dotazione.

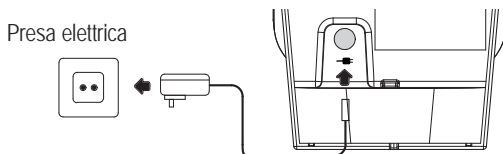

⚠ Attenzione: Utilizzare per la stazione di carica, solo l'alimentatore fornito in dotazione (S002CV0600030 / 6 V, 300 mA DC)!

² Vale solo per set telefonici con minimo due unità portatili, -> "Verificare il contenuto della confezione".

Mettere in funzione il telefono

Inserire l'accumulatore ricaricabile

Inserire le batterie ricaricabili nel vano batterie precedentemente aperto. Chiudere infine il vano accumulatore.

⚠ Attenzione: Utilizzare a tale scopo solo batterie ricaricabili del tipo AAA Ni-MH da 1,2 V.

Osservare la corretta polarità!

Non utilizzare mai batterie/celle primarie!

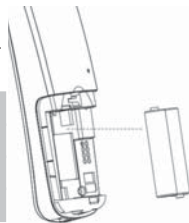

Caricare le batterie

🔋 Riporre l'unità portatile in sede di prima messa in funzione per minimo 16 ore nella stazione base / stazione di carica.

L'unità portatile si surriscalda durante il processo di carica. Questo è un fenomeno normale e non pericoloso. Evitare di caricare l'unità portatile con dispositivi di carica differenti o estranei. L'avviso di batteria scarica verrà visualizzato sul display. Quando il livello di carica della batteria è sceso al limite, sul display lampeggia il simbolo della batteria (🔋) e viene emesso un allarme acustico (nel caso di allarme acustico abilitato/menu „IMPOSTA PT/IMPOSTA TONI/TONO BATT“). Sono ancora a disposizione circa 10 minuti di chiamata.

Impostare ora e data dell'unità portatile

All'accensione l'unità portatile non dispone di un'impostazione oraria corretta (per esempio: per le registrazioni nell'elenco chiamate/segreteria telefonica). Impostate data e ora nel menu „IMPOSTA PT/ DATA E ORA“.

Impostare la lingua di display

La lingua di display può essere impostata in 13 diverse lingue. Il telefono è impostato su "Tedesco". Modificare la lingua nel menu „MT-EINSTEL/ SPRACHE“.

Accettazione di chiamata automatica / Risposta dir

L'attivazione di questa funzione consente di ricevere automaticamente una chiamata estraendo semplicemente l'unità portatile dalla stazione base. L'accettazione di chiamata automatica è attivata o disattivata nel menu „IMPOSTA PT/ RISPOSTA AUT“.

3 Elementi di comando

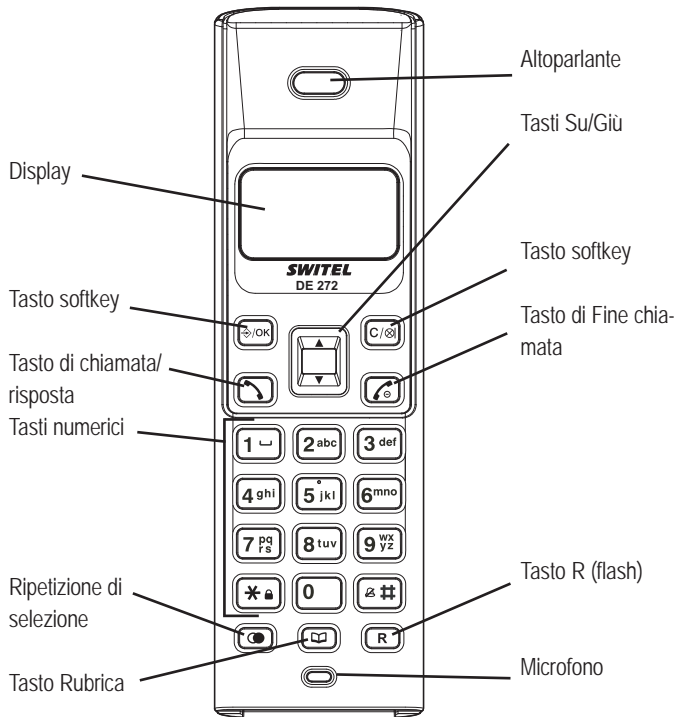



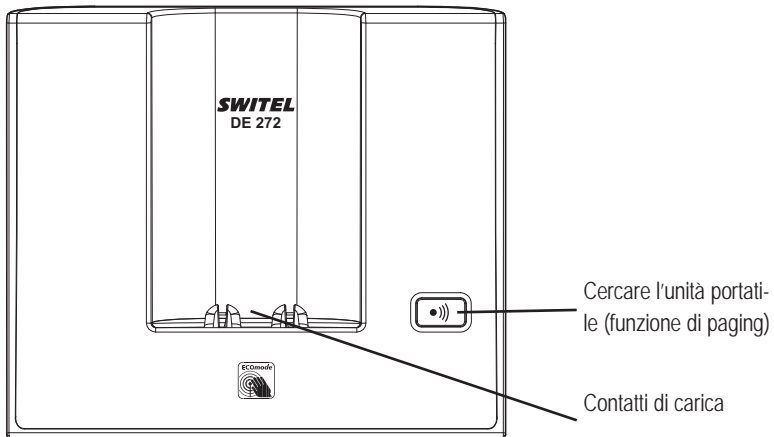



Elementi di comando







4 Informazioni introduttive

In questo capitolo sono riportate le principali informazioni riguardo l'uso delle presenti istruzioni e del telefono.

Modi di rappresentazione delle istruzioni per l'uso

Rappresentazione	Descrizione
	Rappresentazione dei tasti
	Premere il tasto raffigurato
	Inserire numeri o lettere
	L'unità portatile squilla
	Estrarre l'unità portatile dalla stazione base
	Riporre l'unità portatile nella stazione base
NAME?	Rappresentazione di testi sul display
	Rappresentazione di simboli sul display

Simboli sul display dell'unità portatile

Simbolo	Descrizione
	Costante: Collegamento con la stazione base Lampeggiante: Il collegamento con la stazione base si interrompe.
	Costante: Indicazione dello stato di carica delle batterie. Lampeggiante quando l'unità portatile è collegata all'unità base: L'accumulatore ricaricabile è in fase di carica.
	Costante: le batterie dovrebbero essere ricaricate. Lampeggiante: Caricare le batterie.
	Costante: Chiamata in corso. Lampeggiante: Chiamata in arrivo.

Informazioni introduttive



La segnalazione acustica di chiamata è disinserita.



Costante: Funzione allarme inserita.

Lampeggiante: Allarme.



Il blocco tastiera è attivato.



Costante: la segreteria telefonica è collegata.

Lampeggiante: Nuovi messaggi sulla segreteria telefonica.



Nuovo messaggio nella Casella Voce dell'Operatore di Rete (variabile a seconda dell'operatore di rete).



Costante: E' in corso una chiamata interna (solo con più unità portatili registrate su una sola base).

Lampeggiante: Chiamata interna in arrivo.



Con un messaggio dell'elenco chiamate: Nuova Chiamata



Altri tasti cifra/carattere precedenti o successivi al tasto

attualmente selezionato. Per selezionarli premere il relativo softkey.

Nelle seguenti descrizioni del display vengono visualizzate le funzioni disponibili per entrambi i softkey a seconda della modalità.



Aprire il Menu.



Confermare una selezione.



Attivare una chiamata interna (solo per più unità portatili su una sola unità base).



Ritornare al livello precedente del menu o terminare la funzione.



Tornare indietro-cancellare le voci inserite (una pressione breve cancella gli ultimi segni, una pressione più lunga cancella l'intera riga),

Microfono attivo/disattivo durante la conversazione (Muto)

Modalità di stand-by

In tutte le descrizioni del presente manuale di istruzioni si considera l'unità portatile in modalità di stand-by. Per passare alla modalità di stand-by, premere il tasto .

Riduzione delle radiazioni (modalità ECO)



Le radiazioni sono considerevolmente ridotte in modalità conversazione rispetto ad un telefono cordless a standard DECT.

Navigazione nel menu

I differenti menu consentono di raggiungere tutte le funzioni del telefono. La struttura completa del menu si trova in appendice.

Per la navigazione nel menu utilizzare le softkeys ed i tasti freccia.

Utilizzando i Softkeys a sinistra  si accede al menu.

Utilizzare i tasti freccia  e  per navigare all'interno del menu.

Per aprire un sottomenu premere il tasto .

Per ritornare al livello del menu precedente premere brevemente . Premendo più a lungo si ritornerà in modalità stand by.

Creare voci nella rubrica telefonica - Esempio

La navigazione nei menu e la procedura da seguire per inserire nuove voci è indicata a titolo esemplificativo in „Creare voci nella rubrica telefonica“. Si consiglia di seguire quanto riportato nell'esempio per tutte le altre impostazioni che si desiderano compiere.



Aprire la rubrica telefonica.

o



Premere il tasto softkey **Menu**.



Selezionare **RUBRICA** e confermare con **OK**.

Se non è ancora presente alcuna voce verrà visualizzato **VUOTO**. Se vi sono già delle voci inserite, verrà visualizzata la prima voce.



Premere il softkey **Menu**.



Confermare **AGGIUNGI** con **OK**.



Immettere il nome (al massimo 12 caratteri).

I tasti-cifra si immettono con i caratteri. Premere più volte i tasti corrispondenti per inserire i caratteri e le cifre.

Dopo poco tempo il cursore avanza automaticamente.



Concludere l'immissione del nome con **OK**.



Immettere il numero di telefono (al massimo 20 cifre).



Concludere l'immissione del numero di telefono con **OK**.



Selezionare una suoneria per la voce inserita.



Confermare con **OK**.



Ritornare alla modalità stand-by.

5 Compiere telefonate

Ricevere una chiamata



Il telefono suona.

L'unità portatile **non** si trova inserita nell'unità base:



Premere il tasto di risposta.

L'unità portatile non si trova inserita nell'unità base e la **RISPOSTA AUT non** è inserita:



Sollevare l'unità portatile dall'unità base e premere il tasto di risposta.

L'unità portatile non si trova inserita nell'unità base e la **RISPOSTA AUT** è inserita:



E' sufficiente prelevare l'unità portatile dall'unità base; la conversazione sarà automaticamente accettata.

Telefonare



Immettere un numero di chiamata.

In caso di immissione errata, correggere .



Il numero di chiamata viene selezionato.



 E' altresì possibile premere prima il tasto di chiamata e ricevere il segnale di linea libera. Le cifre immesse per la composizione del numero desiderato verranno così selezionate. Con questo tipo di funzione chiamata non è possibile correggere le singole cifre che compongono il numero di chiamata.

Concludere una chiamata



Premere il tasto di fine chiamata o riporre l'unità portatile sull'unità base.

Ripetizione di selezione



 Il telefono memorizza gli ultimi 5 numeri composti. Se il numero è stato inserito nella rubrica del telefono, apparirà il nome memorizzato con quel numero. Per visualizzare il numero corrispondente al nome premere il tasto cancelletto . L'ultimo numero composto apparirà sempre all'inizio dell'elenco.

 /  Aprire l'elenco di ripetizione di chiamata.

 /  Selezionare la voce.

 Il numero di chiamata viene selezionato.

Per chiamare un numero dall'elenco chiamate.

 Il vostro telefono memorizza le ultime 10 chiamate nell'elenco chiamate. Se il numero è stato inserito nella rubrica del telefono, apparirà il nome memorizzato con quel numero. Per visualizzare il numero corrispondente al nome premere il tasto cancelletto . La memorizzazione può avvenire solo, se sulla vostra connessione è disponibile "l'identificazione del numero di chiamata (CLIP)" e se il numero di chi telefona non è trattenuto o non è trasmesso per altri motivi.

 Aprire l'elenco chiamate.

 /  Selezionare la voce.

 Il numero di chiamata viene selezionato.

Effettuare delle chiamate dalla rubrica

 La rubrica può contenere fino a 20 voci. Per immettere una voce vedere la sezione „Rubrica Telefonica“.

 Aprire la rubrica telefonica.

 /  Selezionare la voce.

 Il numero di chiamata viene selezionato.

Visualizzazione della durata di conversazione

Durante lo svolgimento di una chiamata, la durata della telefonata è visualizzata in ore, minuti e secondi.

Impostare il volume del ricevitore



Il volume è regolabile durante lo svolgimento di una chiamata in 5 livelli. Le impostazioni rimangono memorizzate anche una volta terminata la conversazione.

Silenziamento del microfono nell'unità portatile



Durante la conversazione è possibile disattivare il microfono, per fare in modo che il vostro interlocutore non vi possa sentire. Sul display apparirà **MUTO**.



Per attivare il microfono premere il tasto ripristina.

Compiere chiamate interne

 Le conversazioni interne, trasferimenti di chiamata e teleconferenze sono possibili solo quando sono registrate più unità portatili. Se non è questo il caso, sul display verrà visualizzato **IMPOSSIBILE**.

Effettuare chiamate interne



Premere il softkey **Intercom**. Se sono registrate due unità portatili, verrà chiamato subito l'altra unità portatile. Se sono registrate più unità portatili, vengono visualizzati i relativi numeri interni (per esempio 2 3 4). Premere il numero interno desiderato. Premere "9" per chiamare contemporaneamente tutti i telefoni collegati.

Compiere telefonate

Trasferire chiamate esterne



Nel corso di una chiamata esterna. . .

Premere il softkey **Menu**.

Selezionare **INTERNO** e premere **OK**.

Digitare il numero interno. La chiamata esterna verrà trattenuta.

Se l'unità portatile chiamata è accesa, verrà eventualmente annunciata la comunicazione.

Premere il tasto di fine chiamata. La chiamata è stata trasmessa.

Teleconferenza



Nel corso di una chiamata esterna. . .

Premere il softkey **Menu**.

Selezionare **INTERNO** e premere **OK**.

Digitare il numero di chiamata interno.

Quando l'unità portatile chiamata viene inserita, tenere premuto il tasto asterisco fino a quando non appare **CONFERENZA** sul display.

 Se uno dei partecipanti alla teleconferenza riattacca, gli altri partecipanti rimangono connessi fra di loro.

6 Funzioni speciali

Blocco tastiera

 Il blocco tastiera impedisce la digitazione involontaria dei tasti. Le chiamate in arrivo possono essere ricevute come di consueto.



Tenere premuto il tasto asterisco fino a quando appare sul display il simbolo del blocco tastiera.



Per sbloccare la tastiera tenere premuto nuovamente il tasto asterisco fino a quando il simbolo non scompare di nuovo.

Disattivare il tono chiamata sull'unità portatile

 E' possibile disattivare il tono chiamata anche sul menu „IMP SUONERIA/ VOLUME“.



Tenere premuto il tasto cancelletto fino a quando il simbolo di disattivazione tono chiamata  non appare sul display.



Per riattivare il tono chiamata tenere premuto nuovamente il tasto cancelletto fino a quando non riappare il simbolo.

Spegnimento unità portatile

 Per risparmiare la batteria spegnere l'unità portatile.



Tenere premuto il tasto di fine chiamata. Dopo alcuni secondi l'unità portatile si spegnerà. L'illuminazione del display si spegnerà.



Per riaccendere l'unità portatile tenere premuto il tasto di fine chiamata fino a quando non si avverte un segnale acustico e fino a quando il display non si illuminerà di nuovo.

7 Elenco chiamate/ripetizione di selezione

Modificare l'elenco chiamate



Accedere all'elenco chiamate.



Selezionare una voce.



Premere il softkey **Menu**.



Selezionare una delle seguenti opzioni e confermare con **OK**:

AGG A RUBR

Il numero di chiamata verrà memorizzato nella rubrica. Se è inserito un nome, confermare o modificare il numero di telefono ed associare una suoneria per questa voce della rubrica.

ELIMINA

La voce verrà eliminata.

ELIM. TUTTI

L'intera rubrica verrà eliminata a seguito di un'ulteriore richiesta di conferma.

DETTAGLI

Per visualizzare data e ora della chiamata.



E' possibile accedere all'enco chiamate anche dal menu:



LISTA CHIAM [**OK**].

Modificare ripetizione di selezione



Accedere alla ripetizione di selezione.



Selezionare una voce.



Premere il softkey **Menu**.



Selezionare una delle seguenti opzioni e confermare con **OK**:

AGG A RUBR

Il numero di chiamata verrà memorizzato nella rubrica. Se è inserito un nome, confermare o modificare il numero di telefono ed associare una suoneria per questa voce della rubrica.

ELIMINA

La voce verrà eliminata.

ELIM. TUTTI

L'intera rubrica verrà eliminata a seguito di un'ulteriore richiesta di conferma.

8 Rubrica telefonica

 Nella rubrica è possibile memorizzare fino a 20 numeri di telefono e relativi nomi. E' possibile associare ad ogni voce una suoneria, con la quale verrà segnalata la chiamata. Immettere sempre il numero di telefono con il relativo prefisso; questo permetterà una corretta visualizzazione del corrispondente chiamante, per il quale è stata inserita una voce nella rubrica e per il quale sulla vostra connessione è disponibile la trasmissione del numero.

Aggiungere una nuova voce alla rubrica



Premere il tasto rubrica.

Se è ancora stata inserita alcuna voce verrà visualizzato **VUOTO**. Se sono già state inserite delle voci, verrà visualizzata la prima voce.



Premere il softkey **Menu**.



Confermare **AGGIUNGI** con **OK**.



Immettere il nome (al max. 12 caratteri).

Le cifre si immettono con i tasti carattere. Premendo più volte il tasto relativo è possibile inserire caratteri e cifre.

Dopo una breve attesa il cursore procede automaticamente.



Terminare l'immissione del nome con **OK**.



Inserire il numero di telefono (max. 20 cifre). Se il telefono è collegato ad un impianto telefonico interno, è necessario selezionare un numero di accesso alla rete esterna. Se occorre una pausa di selezione, premere il tasto 0 per circa 2 secondi dopo aver inserito il numero di accesso alla rete esterna; sul display apparirà la lettera **P**.



Terminare l'inserimento del numero di chiamata con **OK**.



Selezionare una suoneria per la nuova voce della rubrica.



Confermare con **OK**.



Ritornare alla modalità stand-by.

Rubrica telefonica

 E' possibile accedere alla rubrica anche dal menu.

  /  RUBRICA .

Modificare le voci della rubrica.



Premere il tasto rubrica.



Selezionare la voce.



Premere il softkey **Menu**.



Selezionare una delle seguenti opzioni e confermare con **OK**.

AGGIUNGI

Per aggiungere una nuova voce alla rubrica.

VISUALIZZA

La voce della rubrica verrà visualizzata. Visualizzare Nome, Numero di Telefono e Suoneria con i tasti freccia.

COMPONI

E' possibile modificare l'inserimento di una voce. Eliminare caratteri e cifre con , inserire con i tasti cifra dei nuovi caratteri e nuove cifre. Per ulteriori dettagli consultare "Immettere nuova voce".

ELIMINA

La voce della rubrica verrà eliminata.

ELIM. TUTTI

L'intero elenco verrà eliminato a seguito di un'ulteriore richiesta di conferma.

STATO RUBR

Verrà visualizzata la situazione attuale della rubrica (per esempio **07/20 IN USO**: sono disponibili 7 voci su 20 della rubrica).

9 Impostazioni Telefono

Data/Ora



Premere il softkey **Menu**.



Selezionare **IMPOSTA PT** e premere **OK**.



Selezionare **DATA E ORA** e premere **OK**.



Selezionare una delle seguenti opzioni e confermare con **OK**:

FORMATO DATA Per impostare il formato data:
(DD-MM-YY oppure MM-DD-YY).

FORMATO ORA Per impostare il formato ora:
(24 ore oppure 12 ore).

IMPOSTA ORA Immettere l'ora con i tasti cifra.

IMPOSTA DATA Immettere la data con i tasti cifra.

In caso di interruzione dell'alimentazione elettrica l'impostazione verrà persa, se contemporaneamente l'unità portatile è disattivata o le batterie sono scariche.

Sveglia



Premere il softkey **Menu**.



Selezionare **IMPOSTA PT** e premere **OK**.



Selezionare **SVEGLIA** e premere **OK**.



Selezionare **ATTIVA** e premere **OK**.



Inserire l'ora della sveglia con i tasti cifra.

SNOOZE

Premere **OK**.



Selezionare **ATTIVA** o **DISATTIVA** e premere **OK**.

Se „Snooze“ è inserito, significa che l'allarme della sveglia verrà ripetuto dopo 7 minuti, fino a quando la funzione verrà disattivata tenendo premuto il tasto di fine chiamata.

Se „Snooze“ non è inserito, l'allarme della sveglia verrà emesso solo una volta all'ora impostata. Per arrestare l'allarme della sveglia premere un tasto qualsiasi.

Impostazioni Telefono

Impostare il tono di chiamata dell'unità mobile



Premere il softkey **Menu**.



Selezionare **IMPOSTA PT** e premere **OK**.



Selezionare **IMP SUONERIA** e premere **OK**.



Selezionare una delle seguenti opzioni e confermare con **OK**:

CHIAMATE INT Selezionare una suoneria per la segnalazione di una chiamata interna.

CHIAMATE EST Selezionare una suoneria per la segnalazione di una chiamata esterna.

VOLUME Selezionare il volume per il tono chiamata. Se viene selezionato „SILENZIOSO“ apparirà sul display il simbolo relativo.

Impostazione toni di avviso



Premere il softkey **Menu**.



Selezionare **IMPOSTA PT** e premere **OK**.



Selezionare **IMPOSTA TONI** e premere **OK**.



Selezionare una delle seguenti opzioni e premere **OK**:

TONI TASTI Attivare o disattivare il tono dei tasti.

TONO BATT Attivare o disattivare il tono di avviso che segnala quando la batteria deve essere ricaricata.

FUORIPORTATA Attivare o disattivare il tono che segnala quando l'unità portatile si trova fuori dalla copertura del segnale dell'unità base.

Impostazione lingua del display



Premere il softkey **Menu**.



Selezionare **IMPOSTA PT** e premere **OK**.



Selezionare **LINGUA** e premere **OK**.



Selezionare una lingua e confermare con **OK**.

Impostare nome dell'unità portatile



Premere il softkey **Menu**.



Selezionare **IMPOSTA PT** e premere **OK**.



Selezionare **RINOMINA PT** e premere **OK**.



Eliminare il vecchio nome con **[C]**, inserire il nuovo nome con i tasti cifra e premere **OK**.

Impostazione messaggio display



Premere il softkey **Menu**.



Selezionare **IMPOSTA PT** e premere **OK**.



Selezionare **DISPLAY PT** e premere **OK**.



Selezionare, se in modalità stand-by, il nome dell'unità portatile o l'ora che deve essere visualizzata e confermare con **OK**.

Impostazione Risposta automatica



Premere il softkey **Menu**.



Selezionare **IMPOSTA PT** e premere **OK**.



Selezionare **RISPOST AUT** e premere **OK**.



Selezionare se la risposta automatica deve essere attivata o disattivata e premere **OK**.

Se la risposta automatica è attivata, la chiamata verrà subito accettata nel momento in cui l'unità portatile verrà estratta dall'unità base.

Impostazione modalità di selezione



Premere il softkey **Menu**.



Selezionare **IMPOSTA BS** e premere **OK**.



Selezionare **MODO SELEZ** e premere **OK**.



Selezionare **TONI** o **IMPULSI** e confermare con **OK**.

Per la maggior parte degli impianti telefonici, l'impostazione giusta è **TONI**.

Impostazioni Telefono

Impostazione tempo flash



Premere il softkey **Menu**.



Selezionare **IMPOSTA BS** e premere **OK**.



Selezionare **TEMPO FLASH** e premere **OK**.



Selezionare BREVE (100 ms), MEDIA (300 ms) oppure LUNGO (600 ms) e confermare con **OK**.

Modificare PIN



Premere il softkey **Menu**.



Selezionare **IMPOSTA BS** e premere **OK**.



Selezionare **CAMBIA PIN** e premere **OK**.



Inserire il codice PIN attuale

(nella configurazione predefinita 0 0 0 0) e premere **OK**.



Inserire un nuovo codice PIN e premere **OK**.



Inserire un nuovo codice PIN ancora una volta e premere **OK**.

Il codice PIN a quattro cifre protegge alcune impostazioni da un accesso non autorizzato. Nel caso non si dovesse ricordare il codice PIN, rivolgersi al nostro Servizio di Assistenza.

Rimpostare il telefono secondo la configurazione predefinita



Premere il softkey **Menu**.



Selezionare **DEFAULT** e premere **OK**.



Inserire il codice PIN attuale e premere **OK**.

Confermare anche la successiva richiesta di conferma con **OK**.

La rubrica non viene cancellata. Cancellare la rubrica dal menu-rubrica. L'unità portatile registrata rimane registrata.

10 Registrare/cancellare un'unità portatile

Su una stazione base possono essere registrate fino a 5 unità portatili. Le unità portatili fornite con il vostro telefono sono già registrate con l'unità base. Per registrare un'unità mobile „estranea“ si prega di consultare il manuale di istruzioni.

Registrare un'altra unità mobile dello stesso tipo



Premere il softkey **Menu**.



Selezionare **REGISTRAZ** e premere **OK**.



Inserire l'attuale codice PIN dell'unità di base sulla quale deve essere registrata l'unità portatile e premere **OK**.



Tenere premuto il tasto Paging nell'unità base fino a quando non viene emesso un tono che indica che la registrazione è avvenuta (ca. 5 sec.).

Poco dopo si illumina costantemente sul display il simbolo dell'antenna e l'unità portatile è così registrata.

Cancellare un'unità portatile



Premere il softkey **Menu**.



Selezionare **IMPOSTA BS** e premere **OK**.



Selezionare **CANCELLA PT** e premere **OK**.



Inserire il codice PIN attuale e premere **OK**.



Selezionare una delle unità portatili registrate e premere **OK**.



L'unità portatile in uso non può essere cancellata.

11 Impianti telefonici interni / Servizi aggiuntivi

Impianti telefonici interni

Avendo collegato il telefono ad un impianto telefonico interno, il tasto R consente di accedere a tutte le altre funzioni disponibili come per es. trasferimento di chiamata e funzione di richiamata automatica. Si prega di consultare le istruzioni per l'uso del proprio impianto telefonico interno per individuare il tempo flash da impostare al fine di poter usufruire di queste funzioni. Il rivenditore autorizzato è in grado di indicare se il telefono acquistato funzionerà senza alcun problema nel proprio impianto telefonico interno.

Si consiglia di inserire le voci della rubrica con l'eventuale numero di accesso alla rete esterna e la pausa di selezione necessaria (premere a lungo "0").

Servizi aggiuntivi

Il telefono supporta servizi aggiuntivi messi a disposizione dal proprio gestore di rete telefonica come per es. le funzioni di chiamata in attesa, avviso di chiamata e chiamata a conferenza. Il tasto R consente di accedere a questi servizi aggiuntivi. Si prega di consultare il proprio gestore di rete telefonica per ottenere informazioni sul tempo flash necessario all'utilizzo dei servizi aggiuntivi. Rivolgersi al proprio gestore di rete telefonica per ottenere l'abilitazione ai servizi aggiuntivi.

12 Appendice

Struttura di menu

LISTA CHIAM

RUBRICA

IMPOSTA BS

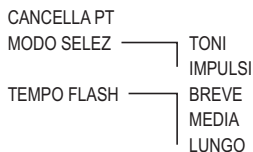

CAMBIA PIN

IMPOSTA PT

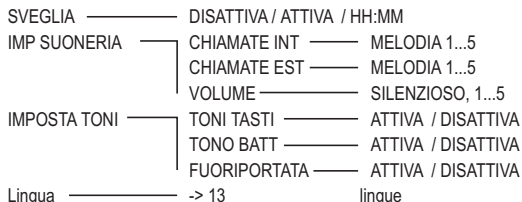

RINOMINA PT

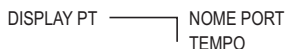

RISPOSTA AUT — ATTIVA / DISATTIVA



REGISTRAZ

DEFAULT

Localizzazione guasti

In presenza di problemi con il telefono, seguire le indicazioni riportate qui di seguito. In caso di problemi tecnici è possibile rivolgersi alla nostra hotline di assistenza tecnica chiamando al numero 0900 00 1675 valido per la Svizzera (spese da rete Swisscom alla data di stampa: CHF 2.00 / min). In caso di reclami entro il periodo di garanzia, rivolgersi al rivenditore autorizzato.

Il periodo di garanzia ricopre 2 anni.

- Dopo la selezione del tasto di risposta non è udibile alcun segnale acustico, la linea non è occupata.
 - Controllare la spina della connessione telefonica sull'unità base e sulla presa del telefono.
 - Controllare la spina elettrica sull'unità di base e sul 230 V.
 - La linea è occupata da un'altra unità portatile. Attendere fino a quando non è terminata la comunicazione.
- Sul display è visualizzato „RICERCA“.
 - Controllare la spina elettrica sull'unità di base e sul 230 V.
 - Ridurre la portata.
 - Cancellare l'unità portatile.
- Nessuna visualizzazione sul display.
 - Unità portatile spenta -> accenderla.
 - Batterie scariche -> caricare le batterie.

Impostazioni predefinite/Configurazioni predefinite

Elenco chiamate	Vuoto
Rubrica telefonica	Vuoto
Sveglia	Disattivato
Suoneria pt	Interno: Melodia 1 Esterno: Melodia 2 Volume: 5
Imposta toni	Toni tasti: Attivato Toni batt: Attivato Fuoriportata: Attivato
Lingua	Tedesco
Nome portatile	DE 27x
Display	Nome portatile
Risposta aut.	Attivato
Data e ora	Formato data: DD-MM-YY Formato ora: 24 ora
Proc selezione	Toni
Tempo flash	Breve (100 ms)
PIN	0 0 0 0

Dati Tecnici

Standard: DECT / GAP

Numero di canali: 120 canali duplex

Frequenza: 1880 MHz - 1900 MHz

Procedura duplex: a divisione di tempo, 10 ms lunghezza trama

Distanza canali: 1728 kHz

Bit rate: 1152 kBit / s

Modulazione: GFSK

Codifica Voce: 32 kBit / s

Potenza di trasmissione: 10 mW (potenza media per canale)

Copertura: fino a 300 metri all'aperto, fino a 50 metri all'interno di un edificio

Alimentazione stazione base:

100~240 V AC (Adattatore S002CV0600030), 6 V DC / 300 mA

Alimentazione Unità di carica:

100~240 V AC (Adattatore S002CV0600030), 6 V DC / 300 mA

Autonomia dell'unità portatile: in stand-by/in conversazione

500 mAh = ca. 100 h / ca. 10 h

Tempo di carica della batteria: ca. 16 Ore

Requisiti ambientali ammessi per il funzionamento dell'unità portatile:

5°C - 45°C ; 20 % - 75 % umidità relativa dell'aria

Requisiti ambientali ammessi per il funzionamento dell'unità base:

5°C - 45°C ; 20 % - 75 % umidità relativa dell'aria

Temperatura di conservazione: -10°C - +60°C

Selezione impostabile: MFV / IWV

Funzione Flash: Flash (100 ms/300 ms/600 ms)

Dimensioni stazione di base (mm): Lungh./Largh./Altezza = 120 x 100 x 95

Dimensioni unità portatile (mm): Lungh./Largh./Altezza = 46 x 28 x 153

Corrispondenza cavo di connessione del telefono:

TSV per Pin 3 e 4 conforme CTR 37 (conformità europea)

Trasformatore: presa europea

Dichiarazione di conformità



Questo apparecchio risponde a quanto disposto dalla Direttiva UE:

- 1999/5/CE Direttiva concernente le apparecchiature radio, le apparecchiature terminali di telecomunicazioni e il reciproco riconoscimento della loro conformità.
- 2005/32/CE Direttiva "Prodotti che consumano energia".
- Regolamento 1275/2008 "Consumo di energia elettrica nei modi stand-by e spento".
- Regolamento 278/2009 "I componenti di rete in caso di peso nullo, nonché la loro efficienza media in funzionamento".

La conformità con la direttiva di cui sopra viene confermata dal marchio CE applicato sull'apparecchio.

Per la dichiarazione di conformità completa si prega di voler usufruire del servizio gratuito di download dal nostro sito Internet www.switel.com.

Consigli per la cura

Pulire le superfici degli apparecchi con un panno morbido e antipilling.

Non utilizzare mai detersivi o solventi.

Garanzia

Gli apparecchi SWITEL sono costruiti e collaudati in osservanza dei processi di produzione più moderni. L'impiego di materiali selezionati e tecnologie altamente sviluppate sono garanti di una perfetta funzionalità e lunga durata in vita. La garanzia non viene considerata esecutiva qualora la causa del malfunzionamento dell'apparecchio è dovuta al gestore della rete telefonica oppure se questa è da attribuirsi ad un impianto telefonico interno interposto. La garanzia non si estende a batterie, accumulatori o batterie ricaricabili utilizzati all'interno degli apparecchi. Il periodo di garanzia ricopre 24 mesi a partire dalla data di acquisto.

Entro il periodo di garanzia si procederà all'eliminazione gratuita di tutti i guasti dovuti a difetti di materiale o produzione. Il diritto di garanzia cessa in caso di interventi da parte dell'acquirente o di terzi. Danni derivanti da un impiego o eser-



cizio non conforme agli usi previsti, a naturale usura, a errato montaggio o errata conservazione, a collegamento o installazione impropri, dovuti a forza maggiore o ad altri influssi esterni non sono coperti da garanzia. In qualità di produttore ci riserviamo il diritto, in caso di reclami, di riparare o sostituire le parti difettose o di rimpiazzare l'apparecchio.

Parti o apparecchi sostituiti passano di nostra proprietà. Sono esclusi diritti di risarcimento per danni qualora non siano dovuti a intenzione o colpa grave del costruttore.

Nel caso in cui il presente apparecchio dovesse ciò nonostante presentare un difetto durante il periodo di garanzia, si prega di rivolgersi esclusivamente al negozio di rivendita dell'apparecchio SWITEL assieme al relativo scontrino di acquisto. In base alle presenti disposizioni, tutti i diritti di garanzia dovranno essere fatti valere esclusivamente nei confronti del rivenditore autorizzato. Decorso il termine di due anni dalla data di acquisto e consegna dei nostri prodotti non sarà più possibile fare valere alcun diritto di garanzia.

Indice alfabetico

A

Accettazione di chiamata automatica	.6
Accumulatore	.2
Alimentatore di rete	.2
Apparecchiature mediche	.3

B

Blocco tastiera	.17
-----------------	-----

C

Caduta di tensione	.2
Caricare le batterie	.6
Chiamate interne	.15
Collegare la stazione base	.5
Concludere una chiamata	.13
Configurazioni predefinite	.29
Consigli per la cura	.31
Contenuto della confezione	.4

D

Data e Ora	.6, 21
Dati Tecnici	.30
Dichiarazione di conformità	.31
Disattivare il tono chiamata sull'unità portatile	.17
Durata di conversazione	.15

E

Elenco chiamate	.14, 18
-----------------	---------

G

Garanzia	.31
----------	-----

I

Impiego conforme agli usi previsti	.2
Impostazioni predefinite	.29
Indicazioni di sicurezza	.2
Inserire l'accumulatore ricaricabile	.6

L

lingua	.22
Lingua di display	.6
Localizzazione guasti	.28
Luogo di installazione	.2

M

Messaggio display	.23
Modalità di selezione	.23
Modalità di stand-by	.11
Modalità ECO	.11

N

Navigazione nel menu	.11
Nome dell'unità portatile	.23

P

PIN	.24
Potenza assorbita	.4

R

Registrare/cancellare un'unità portatile	.25
Ricevere una chiamata	.13
Riduzione delle radiazioni	.11
Rimpostare il telefono	.24



Appendice

Ripetizione di selezione	.14, 18
Risposta automatica	.23
Risposta dir	.6
Rubrica telefonica	.14, 19

S

Servizi aggiuntivi	.26
Silenziamento del microfono	.15
Simboli sul display	.9
Smaltimento	.3
Spegnimento unità portatile	.17
Stazione di carica	.5
Struttura di menu	.27
Sveglia	.21

T

Teleconferenza	.16
Telefonare	.13
Telefonici interni	.26
Tempo flash	.24
Toni di avviso	.22
Tono di chiamata	.22
Trasferire chiamate esterne	.16

V

Volume del ricevitore	.15
-----------------------	-----

1	Safety Information	2
2	Preparing the Telephone	4
3	Operating Elements	7
4	Preliminary Information	9
5	Telephoning	13
6	Other features	17
7	Call list / Redial	18
8	Phone book	19
9	Setting the telephone	21
10	Registering/de-registering handsets	25
11	PBX / Supplementary Services	26
12	Appendix	27

1 Safety Information

Please read this operating instruction manual thoroughly.

Intended use

The telephone is suitable for telephoning within a public telephone network system. Any other use is considered unintended use. Unauthorised modification or reconstruction is not permitted. Under no circumstances open the device or complete any repair work yourself.

Installation location

Prevent excessive exposure to smoke, dust, vibration, chemicals, moisture, heat and direct sunlight.

Do not use the handset in potentially explosive areas.

Power adapter plug

 **Attention:** Only use the power adapter plug supplied because other power supplies could damage the telephone.

Ensure access to the power adapter plug is not obstructed by furniture or such.

Rechargeable batteries

 **Attention:** Never throw batteries into a fire. Only use batteries of the same type. Pay attention to the correct polarity. Incorrect polarity of the batteries represents a risk of explosion during charging.

Power failure

The telephone cannot be used to make calls in the event of a power failure. Always keep a cord connected telephone which operates without an external power supply available in case of emergency situations.

Medical equipment

 **Attention:** Never use the telephone in the vicinity of medical equipment. Effects on such equipment cannot be fully ruled out.

DECT¹ telephones can cause an unpleasant humming sound in hearing aids.

Disposal

In order to dispose of your device, take it to a collection point provided by your local public waste authorities (e.g. recycling centre). The adjacent symbol indicates that the device must not be disposed of in normal domestic waste! According to laws on the disposal of **electronic and electrical devices**, owners are obliged to dispose of old electronic and electrical devices in a separate waste container.

Batteries must be disposed of at the point of sale or at the appropriate collection points provided by the public waste authorities.

Packaging materials must be disposed of according to local regulations.



¹ DECT: **D**igital **E**nhanced **C**ordless **T**elecommunication = Standard for cordless telephones.

2 Preparing the Telephone

Safety information

 **Attention:** It is essential to read the Safety Information in Chapter 1 before starting up.

Checking the package contents

The package contains:

Content	DE 27x model			
	271 ¹	272 ¹	273 ¹	274 ¹
Base station with power adapter plug	1	1	1	1
Charging station with power adapter plug	-	1	2	3
Handset	1	2	3	4
Telephone connection cable	1	1	1	1
Rechargeable batteries	2	4	6	8
Operating instructions	1	1	1	1

¹ Visit www.switel.com to find out whether this telephone is available.

Electrical consumption

The **electrical consumption of the base** is:

- in operation mode (idle/call): approx. 1.2 W
- during charging of the handset: approx. 2 W.

The adaptor input power without load is approx. 0.15 W. The average efficiency is approx. 60 %.

The **electrical consumption of the charger** is:

- without handset charging: approx. 0.15 W
- during charging of the handset: approx. 1.2 W.

The adaptor input power without load is approx. 0.15 W. The average efficiency is approx. 60 %.

Connecting the base station

⚠ Attention: Position the base station at least 1 m away from other electronic devices, otherwise there is a risk of mutual disturbance.

Connect the base station as illustrated in the diagram. For reasons of safety, only use the power adapter plug and telephone connection line supplied.

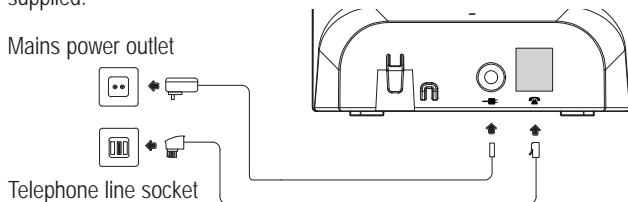

⚠ Attention: Use only the power adapter plug S002CV0600030 / 6 V, 300 mA DC supplied with the base station!

Connecting the charging station²

Connect the charging station as illustrated in the diagram.

For safety reasons, only use the power adapter plug supplied.

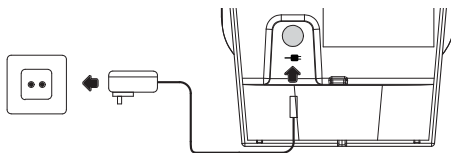

⚠ Attention: Use only the power adapter plug S002CV0600030 / 6 V, 300 mA DC supplied with the charging station!

² Only applies to telephone sets with at least two handsets, see "Checking the package content".

Preparing the Telephone

Inserting the batteries

Open the battery compartment cover. Put in the batteries. Close the battery compartment cover.

⚠ Attention: Use only type AAA NiMH rechargeable batteries. Never use normal batteries / primary cell batteries. Observe the correct polarity!

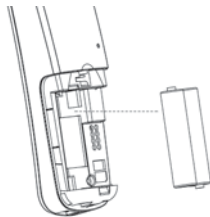

Charging the batteries

🔌 Before the handset is used for the first time, insert it in the base station / charging station for at least 16 hours.

The handset warms up during the charging process. This is normal and does not represent a risk. Use only the adapter plug unit provided for the charging station. The battery status is shown on the display. When the battery capacity is nearly exhausted, the battery symbol (🔋) will flash in the display and you will hear the battery warning sound (if the option is switched on) / menu item "HS SETTINGS/TONE/BATTERY TONE". You still have up to ten minutes of talk time.

Setting the time and date on the handset

At initial operation the handset does not have the correct time (e.g. for entries in the call list). Date and time are set through the menu item "HS SETTINGS/ DATE & TIME".

Setting the display language

The display language is available in 13 languages. The default setting is "German (Deutsch)". Set the language using the menu item "MT-EINSTEL. / SPRACHE".

Auto Answer

If this function is activated, an incoming call is taken when the handset is removed from the base station. The automatic answering function is activated and deactivated using the menu item "HS SETTINGS/ AUTO ANSWER".

3 Operating Elements

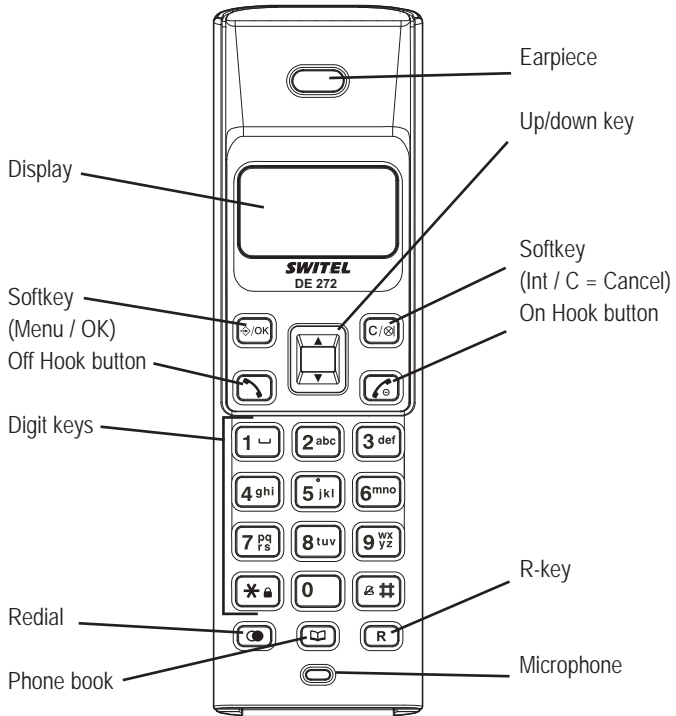



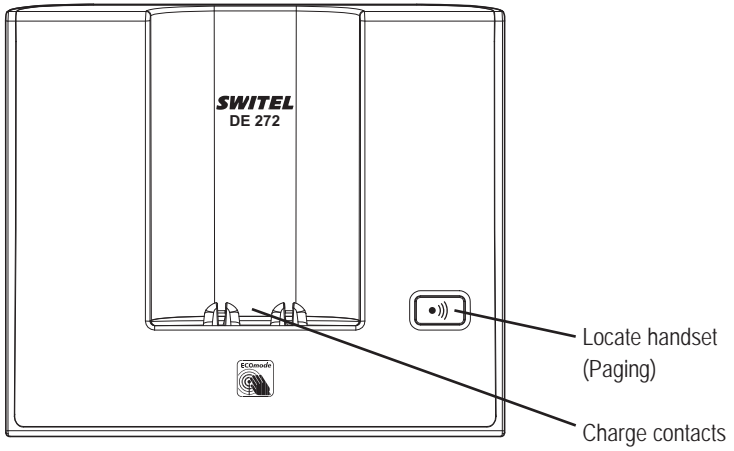



Operating Elements









4 Preliminary Information

This chapter provides basic information on using the operating instruction manual and the telephone.

Description of operating sequences in the manual

Display	Description
	Displays the contour of buttons.
	Press the button depicted.
	Enter digits or letters.
	Handset rings.
	Remove the handset from the base station.
	Place the handset in the base station.
NAME?	Depicts text in the display.
	Depicts icons in the display.

Icons in the handset display

Icon	Description
	On: The connection to the base station is good. Flashing: The connection to the base station is lost.
	On: Indicates the battery charge status. Flashing while handset in base: Batteries are being charged.
	On: Batteries need charging. Flashing: Batteries should be charged immediately.
	On: A call is currently being made. Flashing: A call has been received.
	The ringing tone has been switched off.
	On: The alarm function is activated. Flashing: The alarm is ringing.
	The key lock is activated

Preliminary Information



You received a message in your answering machine provided by the telephone network (depending on telephone network/provider).



On: You can conduct an internal call (only with several handsets registered on the base station).



Flashing: Incoming internal call.



While browsing call list: New call.

Character overflow left/right. Use the up-/down key to scroll.

The functions assigned to the two **softkeys** are shown in the lowest line of the display. The key function changes automatically according to the operating status of the handset.



Accessing the menu.



Confirmation.



Making an internal call (only with several handsets registered on the base station).



Back to the previous menu or cancel programming.



Backwards deleting of characters during entry (brief pressing deletes one character, long pressing deletes the whole line),

Muting/unmuting the microphone during a call.

Standby mode

All descriptions in this operating manual assume that the handset is in Standby mode. The system switches to Standby mode by pressing the  button.

Low-radiation operation (ECO mode)



In call mode, the radiation is reduced considerably as compared to standard, cordless DECT telephones.

Navigating in the menu

All the functions can be accessed via the various menus. The entire menu structure can be found in the appendix.

The softkeys and the arrow keys are used for navigation in the menu.

The menu is opened with the left softkey .

Use the arrow keys  and  to move within the menu

Press the softkey  to open a sub menu.

To return to the main menu press  briefly. With a long press you will return to the standby state.

Creating phone book entries - example

The way in which to navigate through the menus and enter data is explained by means of the example "Creating phone book entries". Proceed as in this example for all the settings.



Press the phone book key.

or



Press the **Menu** softkey.

Select **PHONEBOOK** and confirm with **OK**.

Empty telephone book: **EMPTY** is shown.

If there are entries yet: the first entry is shown.



Press the **Menu** softkey.

Confirm **ADD** with **OK**.



Enter the name (max. 12 digits).

Letters are also imprinted on the digit keys. Letters, digits and special characters are entered by pressing the relevant key the respective number of times.

After a short time the cursor skips one position forwards.



Confirm with **OK**.



Enter the phone number (max. 20 digits).



Confirm with **OK**.



Select a melody for the entry.



Confirm with **OK**.



Back to Standby mode.

5 Telephoning

Taking a call



Your phone is ringing.

If the handset is **not** in the base station:



Press the Off Hook button.

If the handset is in the base station and **AUTO ANSWER** is **not** activated:



Remove the handset from the base and press the Off Hook button.

If the handset is in the base station and **AUTO ANSWER** is activated:



Remove the handset from the base - the call will be taken automatically.

Making a call



Enter the telephone number.

Delete wrong characters pressing **C**.



The telephone number is being dialled.

 You can also press the Off Hook button and you will hear the dialling tone. The entered number will be dialled immediately. It is not possible to correct wrong digits individually using this dialling procedure.

Ending a call



Press the On Hook button or replace the handset in the base station.

Telephoning

Redial

 Your handset saves the last 5 dialled telephone numbers. If a caller is stored in your phone book, the name will be displayed.

Whilst the name is displayed to show the respective number press .

The most recent last number will be displayed at the top of the list.



Open the redial list.





Select an entry.



Dial out the telephone number.

Making a call from the call list

 Your handset saves the numbers of the last 10 incoming calls in the call list. If a caller is stored in your phone book, the name will be displayed.

Whilst the name is displayed to show the respective number press .

Saving can only take place if the function "Phone number transmission (CLIP)" is available at your connection and caller ID is not suppressed by the caller or was not transmitted for any other reason.



Open the call list.



Select an entry.



Dial out the telephone number.

Making a call from the phone book

 You can store up to 20 entries in the phone book.

For creating entries see section "Phone book".



Open the telephone book.



Select the name of the person you wish to call.



Dial out the telephone number.

Call timer

Your handset automatically times the duration of every call in hours, minutes and seconds.

Setting the earpiece/loudspeaker volume



During a call you can adjust the volume in 5 levels.

This setting will remain at the last selected level when you end the call.

Muting the microphone



During a call you can switch your handset's microphone off.

The display shows **MUTED**.



To unmute press the c softkey again.

Internal calls

 Internal calls, transfers and conference calls are only possible if multiple handsets are registered. If this is not the case **NOT POSSIBLE** will be indicated on the display.

Making an internal call



Press the **Internal** softkey. If two handsets are registered to the base station the other handset will be called immediately.

If three or more handsets are registered to the base station their internal numbers will be displayed (for example 2 3 4).

Press the internal number you want to call.

If you press "9" in the case of several registered handsets all will be called at the same time.

Transferring an external call to another handset



During an external call . . .

Press the **Menu** softkey.



Select **INTERCOM** and press **OK**.



Enter the internal telephone number. The external call is put on hold. When the called handset answers you can announce the call transfer.



Press the On-Hook key. The call will be transferred.

3-Party Conference



During an external call . . .

Press the **Menu** softkey.



Select **INTERCOM** and press **OK**.



Enter the internal telephone number.



When the called handset answers ... press and hold down the star key until **CONFERENCE** appears in the display.

 Any handset hangs up during a conference call will leave the other handset still in connection with the external call.

6 Other features

Key lock

 The key lock prevents functions assigned to buttons being activated inadvertently. Incoming calls can still be taken in the normal way even when the key lock function is activated.



Press and hold down the star-key until the key lock icon appears in the display.



For unlocking the keypad again press and hold down the star-key until the icon disappears.

Switching the handset ringer on/off

 You can turn off the ringer via the menu item "HS SETTINGS/RING SETUP/RING VOLUME" as well.



Press and hold down the #-key until the  icon appears in the display.



For turning the ringer on again press and hold down the #-key until the icon disappears.

Switching off the handset

 You can switch off the handset for saving battery capacity.



Press and hold down the On Hook-button. After a few seconds the handset will be switched off. The display illumination goes down.



For switching the handset on again press and hold down the On Hook-button until you hear a short beep and the display is illuminated.

7 Call list / Redial

Editing the call list



Open the call list.



Select an entry.



Press the **Menu** softkey.



Select one of the following options and confirm with **OK**:

ADD TO PB

The telephone number will be stored in the telephone book.

Enter a name, confirm or edit the telephone number and select a ringtone melody for the entry.

DELETE

The entry will be deleted.

DELETE ALL

The complete list will be deleted after a confirmation query.

DETAILS

The respective call's date and time is shown.



You can access the call list via the menu as well:



CALL LIST **OK**).

Editing the redial list



Open the redial list.



Select an entry.



Press the **Menu** softkey.



Select one of the following options and confirm with **OK**:

ADD TO PB

The telephone number will be stored in the telephone book.

Enter a name, confirm or edit the telephone number and select a ringtone melody for the entry.

DELETE

The entry will be deleted.

DELETE ALL

The complete list will be deleted after a confirmation query.

8 Phone book

 Your phone can store up to 20 private phonebook entries with names and numbers. You can also select different ringtones for your phonebook entries. Always enter the phone numbers with the area code; this enables a correct display of the respective caller for whom there is an existing entry and whose phone number transmission to your connection is available.

Creating a new entry



Press the phone book key.
 Empty telephone book: **EMPTY** is shown.
 If there are entries yet: the first entry is shown.



Press the **Menu** softkey.
 Confirm **ADD** with **OK**.
 Enter the name (max. 12 digits).

Letters are also imprinted on the digit keys. Letters, digits and special characters are entered by pressing the relevant key the respective number of times.

After a short time the cursor skips one position forwards.



Confirm with **OK**.
 Enter the phone number (max. 20 digits). If your telephone is connected to a PBX start the telephone number with the access code. If a dialling pause is needed, press after the access code the **0** key for approx. 2 sec. A **P** appears in the display.



Confirm with **OK**.
 Select a melody for the entry.
 Confirm with **OK**.
 Back to Standby mode.

 You can access the telephone book via the menu as well:



PHONEBOOK 

Editing telephone book entries



Press the phone book key.



Select an entry.



Press the **Menu** softkey.



Select one of the following options and confirm with **OK**:

ADD

You can create a new entry.

VIEW

The entry is shown. Using the up/down key you switch between name, number and melody.

EDIT

You can edit the entry. Use the "C" softkey to delete characters and numbers then add new characters and numbers as required. Please refer to "Creating a new entry".

DELETE

The entry will be deleted.

DELETE ALL

The complete list will be deleted after a confirmation query.

PB STATUS

The current allocation will be displayed (e.g. **07/20 USED**: 7 of 20 possible entries are present).

9 Setting the telephone

Date/Time



Press the **Menu** softkey.



Select **HS SETTINGS** and press **OK**.



Select **DATE & TIME** and press **OK**.



Select one of the following options and confirm with **OK**:

DATE FORMAT

You can select your desired date format:
(DD-MM-YY or MM-DD-YY).

TIME FORMAT

You can select your desired time format:
(24 hours or 12 hours).

SET TIME

Enter the time using the digit keys.

SET DATE

Enter the date using the digit keys.



In case of mains failure this setting will be deleted when simultaneously the handset will be switched off or the batteries will be empty.

Alarm



Press the **Menu** softkey.



Select **HS SETTINGS** and press **OK**.



Select **ALARM** and press **OK**.



Select **ON** and press **OK**.



Enter the alarm time using the digit keys.

SNOOZE

Press **OK**.



Select **ON** or **OFF** and press **OK**.

If "Snooze" is turned on it means that the alarm signal is being repeated after 7 minutes until this function is terminated by pressing and holding the off hook button.

If "Snooze" is turned off the alarm signal is given once at the specified time. To confirm the alarm signal, press any key.

Setting the telephone

Setting the ringer for the handset



Press the **Menu** softkey.



Select **HS SETTINGS** and press **OK**.



Select **RING SETUP** and press **OK**.



Select one of the following options and confirm with **OK**:

INT. RING

Select a melody for internal calls.

EXT. RING

Select a melody for external calls.

RING VOLUME

Select the volume. If you select „VOLUME OFF“ the respective icon appears in the display.

Setting the alert tones



Press the **Menu** softkey.



Select **HS SETTINGS** and press **OK**.



Select **TONE SETUP** and press **OK**.



Select one of the following options and confirm with **OK**:

KEY TONE

Switch the keytone on or off.

BATTERY TONE

Switch the alert tone on or off. The tone sounds if “Low battery” is detected.

OUT OF RANGE

Switch the alert tone on or off. The tone sounds if “Out of range” is detected.

Setting the display language



Press the **Menu** softkey.



Select **HS SETTINGS** and press **OK**.



Select **LANGUAGE** and press **OK**.



Select a language and press **OK**.

Setting the handset name



Press the **Menu** softkey.



Select **HS SETTINGS** and press **OK**.



Select **RENAME HS** and press **OK**.



Delete the old name with **C**, enter a new name using the digit keys and confirm with **OK**.

Setting the display



Press the **Menu** softkey.



Select **HS SETTINGS** and press **OK**.



Select **HS DISPLAY** and press **OK**.



Select whether in standby-mode the handset's name or the time will be displayed and confirm with **OK**.

Setting Auto Answer



Press the **Menu** softkey.



Select **HS SETTINGS** and press **OK**.



Select **AUTO ANSWER** and press **OK**.



Select whether the automatic answer function will be on or off and confirm with **OK**.

If **AUTO ANSWER** is on an incoming call will immediately be taken when the handset is taken from the base.

Setting the dial mode



Press the **Menu** softkey.



Select **BS SETTINGS** and press **OK**.



Select **DIAL MODE** and press **OK**.



Select **TONE** or **PULSE** and press **OK**.

In most situations the **TONE** option should be selected.

Setting the telephone

Setting the Flash Time



Press the **Menu** softkey.



Select **BS SETTINGS** and press **OK**.



Select **FLASH TIME** and press **OK**.



Select **SHORT** (100 ms), **MEDIUM** (300 ms) or **LONG** (600 ms) and confirm with **OK**.

Editing the PIN



Press the **Menu** softkey.



Select **BS SETTINGS** and press **OK**.



Select **CHANGE PIN** and press **OK**.



Enter the relevant PIN (default 0 0 0 0) and press **OK**.



Enter the new PIN and press **OK**.



Enter the new PIN again and press **OK**.



The four digit PIN protects some settings against unauthorized changes.

If you have forgotten your PIN please call our service hotline.

Resetting your phone



Press the **Menu** softkey.



Select **DEFAULT** and press **OK**.



Enter the relevant PIN (default 0 0 0 0) and press **OK**.

Confirm the confirmation query with **OK**.



The phone book entries will not be deleted. Please delete the phone book using the menu item "PHONE BOOK/DELETE ALL"

The registration of handsets will not be changed.

10 Registering/de-registering handsets

5 handsets can be registered to a base station. The handsets delivered with your telephone are already registered. To register a "foreign" handset please refer to it's user manual.

Registering a handset of the same type



Press the **Menu** softkey.



Select **REGISTRATION** and press **OK**.



Enter the relevant PIN for the base, the new handset should be registered on, and press **OK**.



Press and hold down the paging key on the base station until a short beep is to be heard (approx. 5 sec).

After a few seconds the antenna icon on the display is on. The handset is registered.

Deleting a handset



Press the **Menu** softkey.



Select **BS SETTINGS** and press **OK**.



Select **DELETE HS** and press **OK**.



Enter the relevant PIN and press **OK**.



Select a handset and press **OK**.

You cannot de-register the handset you are currently using.

11 PBX / Supplementary Services

PBX

If the telephone is connected to a private branch exchange, functions such as transferring calls and automatic call back can be used via the R button.

Refer to the operating manual provided with your private branch exchange as to which Flash time must be set in order to use these functions. The sales outlet where you purchased the exchange can provide information as to whether the telephone will work properly with the exchange.

Please remember to enter the access code and a necessary dialling pause (longpress "0") when creating phone book entries.

Supplementary services

Your telephone supports supplementary services provided by your telephone network provider, such as brokering, call waiting and conference facilities.

These supplementary services can be used via the R-button.

Please contact your telephone network provider regarding which Flash time must be set to use the supplementary services. Contact your telephone network provider with regard to enabling supplementary services.

12 Appendix

Menu Structure

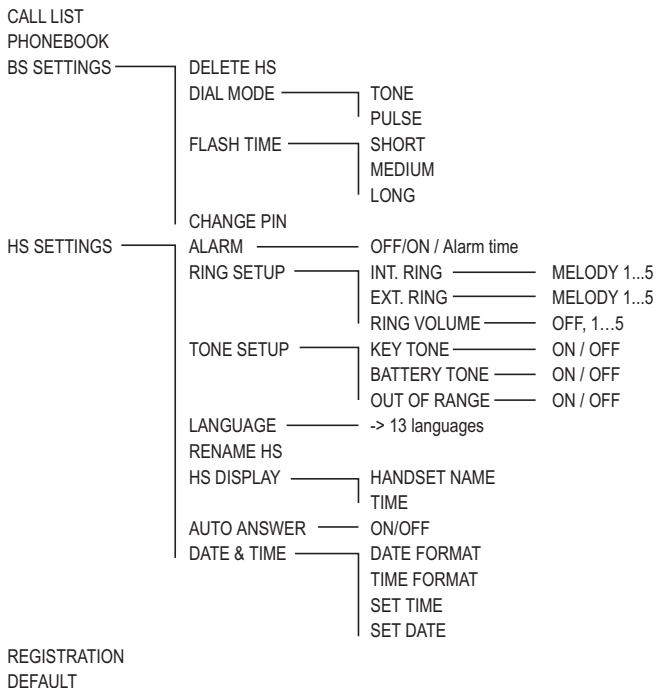

In Case of Problems

Should problems arise with the telephone, please refer to the following information first. In the case of technical problems, you can contact our hotline service, Tel. 0900 00 1675 within Switzerland (Costs for call from Swisscom landline at time of going to print: CHF 2.00/min). In the case of claims under the terms of guarantee, contact your sales outlet. There is a 2 year period of guarantee.

- After pressing the on hook button, no ring tone is audible, the line is not engaged.
 - Check the telephone connector on the base station and on the wall socket.
 - Check power connector on the base station and on 230 V.
 - The line is being occupied by another handset. Wait until the connection is terminated.
- Display: „SEARCHING“.
 - Check power connector on the base station and on 230 V.
 - Reduce range.
 - Register handset.
- No display.
 - Handset turned off -> turn on.
 - Battery empty -> recharge.

Default settings

Call list	No entry
Phonebook	No entry
Alarm	Off
Ringer handset	Internal call: Melody 1 External call: Melody 2 Volume: 3
Tone setup	Key tone: On Battery tone: On Out of range: On
Language	German
Handset name	DE 27x
Handset display	Handset name
Auto answer	On
Date & Time	Date format: DD-MM-YY Time format: 24 hours
Dial mode	Tone
Flash time	Short (100 ms)
PIN	0 0 0 0

Technical data

Standard: DECT / GAP

Number of channels: 120 duplex channels

Frequencies: 1880 MHz to 1900 MHz

Duplex mode: Time division multiplex, 10ms frame length

Channel spacing: 1728 kHz

Bit rate: 1152 kBit / s

Modulation: GFSK

Voice encoding: 32 kBit / s

Transmitter power: 10 mW (average power per channel)

Range: up to 300 m outside, up to 50 m inside buildings

Electricity supply base station:

100~240 V AC (adapter plug S002CV0600030), 6 V DC / 300 mA

Electricity supply charger:

100~240 V AC (adapter plug S002CV0600030), 6 V DC / 300 mA

Handset: Operating time: Stand-by time / Talk time

500 mAh = up to 100 h / up to 10 h

Charging time: approx. 16 hours

Operating temperature for handset operation:

5°C to 45°C ; 20 % to 75 % rel. humidity

Operating temperature for base station operation:

5°C to 45°C ; 20 % to 75 % rel. humidity

Storage temperature: -10°C to +60°C

Dial mode: Tone / Pulse

R-key : Flash time (100 ms/300 ms/600 ms)

Base station dimensions (mm): L / W / H = 110 x 100 x 95

Handset dimensions (mm): L / W / H = 46 x 28 x 153

Telephone line cord:

TSV on Pin 3 and 4 according to CTR 37 (Euro)

Adapter plug: European-type mains connector

Declaration of Conformity



This device fulfils the requirements stipulated in the EU directives:

- 1999/5/EU directive on radio equipment and telecommunications terminal equipment and the mutual recognition of their conformity.
- 2005/32/EU directive "Energy-using products".
- Regulation 1275/2008 "Electric power consumption in standby- and off-state".
- Regulation 278/2009 "External power supplies without load and their average efficiency in use".

Conformity with the above mentioned directives is confirmed by the CE symbol on the device.

To view the complete Declaration of Conformity, please refer to the free download available on our web site www.switel.com.

Maintenance

Clean the housing surfaces with a soft, fluff-free cloth.

Do not use any cleaning agents or solvents.

Guarantee

SWITEL equipment is produced and tested according to the latest production methods. The implementation of carefully chosen materials and highly developed technologies ensure trouble-free functioning and a long service life. The terms of guarantee do not apply where the cause of equipment malfunction is the fault of the telephone network operator or any interposed private branch extension system. The terms of guarantee do not apply to the batteries or power packs used in the products. The period of guarantee is 24 months from the date of purchase.

All deficiencies related to material or manufacturing errors within the period of guarantee will be redressed free of charge. Rights to claims under the terms of guarantee are annulled following tampering by the purchaser or third parties. Damage caused as the result of improper handling or operation, normal wear and tear, incorrect positioning or storage, improper connection or instal-

Appendix

lation or Acts of God and other external influences are excluded from the terms of guarantee. In the case of complaints, we reserve the right to repair defect parts, replace them or replace the entire device. Replaced parts or devices become our property. Rights to compensation in the case of damage are excluded where there is no evidence of intent or gross negligence by the manufacturer.

If your device shows signs of defect during the period of guarantee, please return it to the sales outlet in which you purchased the SWITEL device together with the purchase receipt. All claims under the terms of guarantee in accordance with this agreement can only be asserted at the sales outlet.

No claims under the terms of guarantee can be asserted after a period of two years from the date of purchase and hand-over of the product.

Index**A**

Alarm	21
Alert tones	22
Auto Answer	6, 23

C

Call list	14, 18
Call timer	15
Charging the batteries	6
Conference	16
Connecting the base station	5
Connecting the charging station	5

D

Date/time	6, 21
Declaration of Conformity	31
Default settings	29
Dial mode	23
Display	23
Display language	6
Disposal	3

E

Earpiece/loudspeaker volume	15
ECO mode	11
Electrical consumption	4
Ending a call	13

F

Flash Time	24
------------------	----

G

Guarantee	31
-----------------	----

H

Handset name	23
--------------------	----

I

Icons	9
In Case of Problems	28
Inserting the batteries	6
Installation location	2
Intended use	2
Internal calls	15

K

Key lock	17
----------------	----

L

Language	22
Low-radiation operation	11

M

Maintenance	31
Making a call	13
Medical equipment	3
Menu Structure	27
Muting the microphone	15

N

Navigating in the menu	11
------------------------------	----

P

Package contents	4
------------------------	---

Appendix

PBX26
Phone book14, 19
PIN24
Power adapter plug2
Power failure2

R

Rechargeable batteries2
Redial14, 18
Registering/de-registering handsets .	.25
Reset24
Ringer22

S

Safety Information2
Standby mode11
Supplementary services26
Switching off the handset17
Switching the handset ringer on/off .	.17

T

Taking a call13
Technical data30
Transferring an external call16

SWITEL

Declaration of conformity

Diese Anlage entspricht der europäischen R&TTE Richtlinie.

Für die komplette Konformitätserklärung nutzen Sie bitte den kostenlosen Download von unserer Website www.switel.com.

Cet équipement est conforme à la directive européenne R&TTE.

Pour obtenir la déclaration de conformité intégrale, veuillez vous servir du téléchargement gratuit de notre site Internet www.switel.com.

Quest'apparecchiatura è conforme alla direttiva europea R&TTE.

Per la dichiarazione di conformità completa si prega di voler usufruire del servizio gratuito di download dal nostro sito Internet www.switel.com.

This equipment complies with the European R&TTE directive.

To view the complete Declaration of Conformity, please refer to the free download available at our web site: www.switel.com.

